



INSTRUCTION MANUAL

VHF/UHF DIGITAL TRANSCEIVER IC-92AD

This device complies with Part 15 of the FCC Rules. Operation is subject to the following two conditions: (1) this device may not cause harmful interference, and (2) this device must accept any interference received, including interference that may cause undesired operation.

WARNING: MODIFICATION OF THIS DEVICE TO RECEIVE CELLULAR RADIOTELEPHONE SERVICE SIGNALS IS PROHIBITED UNDER FCC RULES AND FEDERAL LAW.

Icom Inc.



FOREWORD

Thank you for purchase of this fine Icom product. We understand you have a choice of many different radios in the market place. Many hours of research and development went into the design of your IC-92AD, following Icom's philosophy of "technology first."

The IC-92AD VHF/UHF FM TRANSCEIVER is designed with Icom's superior technology and craftsmanship combining traditional analog technologies with the new digital D-STAR technologies for a balanced packaged.

With proper care, this product should provide you with years of trouble-free operation. We want to take a couple of moments of your time to thank you for making your IC-92AD your radio of choice, and hope you agree with Icom's philosophy of "technology first."

EXPLICIT DEFINITIONS

WORD	DEFINITION
⚠-WARNING!	Personal injury, fire hazard or electric shock may occur.
CAUTION	Equipment damage may occur.
NOTE	Recommended for optimum use. No risk of personal injury, fire or electric shock.

FEATURES

- *DV mode (Digital voice + Low-speed data communication) operation ready*
 - *Text message and call sign exchange*
 - *Transmitting position data with a third-party GPS receiver*
- *Waterproof construction (IPX7)*
- *GPS receiver connectable*
 - *Optional HM-175GPS is required*
- *Simple band scope*
- *Dualwatch operation*
- *Optional PC remote control*

IMPORTANT

READ ALL INSTRUCTIONS carefully and completely before using the transceiver.

SAVE THIS INSTRUCTION MANUAL— This instruction manual contains important operating instructions for the IC-92AD.

PRECAUTIONS

⚠ WARNING RF EXPOSURE! This device emits Radio Frequency (RF) energy. Caution should be observed when operating this device. If you have any questions regarding RF exposure and safety standards please refer to the Federal Communications Commission Office of Engineering and Technology's report on Evaluating Compliance with FCC Guidelines for Human Radio Frequency Electromagnetic Fields (OET Bulletin 65)

⚠ WARNING! NEVER hold the transceiver so that the antenna is very close to, or touching exposed parts of the body, especially the face or eyes, while transmitting. The transceiver will perform best if the microphone is 5 to 10 cm (2 to 4 inches) away from the lips and the transceiver is vertical.

⚠ WARNING! NEVER operate the transceiver with an earphone, headphones or other audio accessories at high volume levels. Hearing experts advise against continuous high volume operation. If you experience a ringing in your ears, reduce the volume level or discontinue use.

⚠ WARNING! NEVER operate the transceiver while driving a vehicle. Safe driving requires your full attention—anything less may result in an accident.

NEVER connect the transceiver to a power source of more than 16 V DC. This will ruin the transceiver.

NEVER connect the transceiver to a power source using reverse polarity. This will ruin the transceiver.

DO NOT operate the transceiver near unshielded electrical blasting caps or in an explosive atmosphere.

DO NOT push the PTT when not actually desiring to transmit.

BE CAREFUL! The transceiver will become hot when operating it continuously for long periods.

DO NOT use or place the transceiver in direct sunlight or in areas with temperatures below -20°C (-4°F) or above $+60^{\circ}\text{C}$ ($+140^{\circ}\text{F}$).

Place the unit in a secure place to avoid inadvertent use by children.

DO NOT use of chemical agents such as benzine or alcohol when cleaning, as they can damage the transceiver's surfaces.

For U.S.A. only

CAUTION!: Changes or modifications to this device, not expressly approved by Icom Inc., could void your authority to operate this device under FCC regulations.

PRECAUTIONS

◆ Important notes when using GPS receiver

- Please do not use the HM-175GPS close the TX antenna. The transmit signal may cause GPS receiver malfunction.
- The GPS signal cannot pass through the metal object. When using the HM-175GPS inside a vehicle, you may not receive GPS signal. We recommend to use it window side. Please avoid the areas shown in the following:
 1. DO NOT use where it will block the driver's view.
 2. DO NOT use where the air bags could deploy.
 3. DO NOT use it when becoming the obstacle of driving.
- The Global Positioning System (GPS) is built and operated by the U.S. Department of Defence. The Department is responsible for accuracy and maintenance of the system. Any changes that the Department makes may affect the accuracy and function of the GPS system.
- When GPS receiver is activated, please do not cover the HM-175GPS with any object.
- The GPS receiver may not work if used in the following locations:
 1. Tunnels or high-rise buildings
 2. Underground parking lot
 3. Under a bridge or viaduct
 4. In remote forested areas
 5. Under bad weather condition (rainy or cloudy day)

SUPPLIED ACCESSORIES

The following accessories are supplied with the transceiver.

- | | |
|-------------------------------------|-------|
| ① Hand strap | 1 |
| ② Antenna | 1 |
| ③ Battery pack (BP-256) | 1 |
| ④ Battery charger (BC-167A/E) | 1 |
| ⑤ Belt clip (with screws) | 1 set |

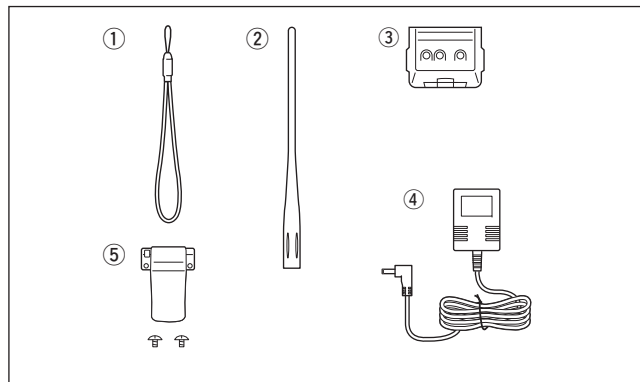

NOTICES

◇ Using the optional HM-175GPS

Noise signals from the HM-175GPS may interfere with the IC-92AD's AM radio or HF band reception.

In this case, set the HM-175GPS's microphone cable as distant to the antenna as far as possible, or turn off the HM-175GPS.

◇ Data output from HM-175GPS

The optional HM-175GPS outputs GPS data (position data, etc.) to IC-92AD at intervals while receiving only. Therefore, the transceiver is not updated GPS data while transmitting.

The transceiver transmits GPS data that was received prior to the last IC-92AD DV mode transmit.

◇ About OPC-1797

- NEVER connect the optional OPC-1797 CONNECTION CABLE with non-Icom article specified.
- When connecting a monaural plug to 2.5 (d) mm, it acts as short and becomes a cause of failure.
- Turn power OFF when connecting or disconnecting the OPC-1797.

Icom, Icom Inc. and the Icom logo are registered trademarks of Icom Incorporated (Japan) in the United States, the United Kingdom, Germany, France, Spain, Russia and/or other countries.

Microsoft, Windows and Windows Vista are either registered trademarks or trademarks of Microsoft Corporation in the United States and/or other countries.

APRS® is a registered trademark of Mr. Bob Bruninga in the U.S.A. and other countries.

TABLE OF CONTENTS

FOREWORD	i
EXPLICIT DEFINITIONS	i
FEATURES	i
IMPORTANT	i
PRECAUTIONS	ii, iii
SUPPLIED ACCESSORIES	iii
NOTICES	iv
TABLE OF CONTENTS	v–vii
1 ACCESSORY ATTACHMENT	1
■ Antenna	1
■ Belt clip	1
■ Hand strap	1
■ Battery pack	1
2 PANEL DESCRIPTION	2–7
■ Front, top and side panels	2
■ Function display	6
3 BATTERY CHARGING	8–13
■ Caution	8
■ Regular charging	10
■ Rapid charging	11
■ Optional battery case	12
■ Battery information	12
■ External DC power operation	13
4 FREQUENCY AND CHANNEL SETTING	14–19
■ Main band selection	14
■ Mode selection	15
■ Operating band selection	16
■ Setting a tuning step	18
■ Setting a frequency	18
5 BASIC OPERATION	20–28
■ Receiving	20
■ Setting audio volume	20
■ Setting squelch level	21
■ Operating mode selection	21
■ Monitor function	22
■ Attenuator function	22
■ Band scope	23
■ Transmitting	24
■ Transmit power selection	24
■ Lock function	25
■ Dualwatch operation	25
■ TV channel operation	28
6 REPEATER AND DUPLEX OPERATIONS	29–33
■ Repeater operation	29
■ Duplex operation	31
■ Auto repeater function	32
■ 1750 Hz tone	33
7 DV MODE OPERATION	34–59
■ Digital mode operation	34
■ Call sign programming	34
■ Digital voice mode operation	38
■ About the D-STAR system	40
■ Digital repeater operation	41
■ Received call sign	46
■ Copying the call sign	48
■ Break-in communication	51
■ Message operation	52
■ Automatic reply function	54
■ EMR (Emergency) communication	56

TABLE OF CONTENTS

■ Low-speed data communication	56
■ Other function for DV mode operation	58
8 GPS/GPS-A OPERATION	60–70
■ GPS operation	60
■ GPS set mode items	68
■ GPS-A operation	70
9 MEMORY/CALL CHANNELS	71–81
■ General description	71
■ Selecting a memory channel	72
■ Selecting a call channel	73
■ Memory channel programming	74
■ Memory bank setting	75
■ Memory bank selection	76
■ Programming memory/bank/scan name	77
■ Selecting memory/bank name indication	78
■ Copying memory/call contents	79
■ Memory clearing	80
■ Erasing/transferring bank contents	81
10 SCAN OPERATION	82–89
■ Scan types	82
■ Full/band/programmed scan	83
■ Scan edges programming	84
■ Memory scan	85
■ Memory bank scan	86
■ Skip channel/frequency setting	87
■ Scan resume condition	89
11 PRIORITY WATCH	90–92
■ Priority watch types	90
■ Priority watch operation	91
12 MENU SCREEN OPERATION	93–116
■ General	93
■ MENU screen indication for A band	94
■ MENU screen indication for B band	94
■ Menu list	94
■ Items list	94
■ Set mode items	96
■ DV set mode items	100
■ Scan set mode items	108
■ DUP/TONE set mode items	110
■ Display set mode items	112
■ Sounds set mode items	115
13 OTHER FUNCTIONS	117–133
■ Programming a DTMF code	117
■ Transmitting a DTMF code	118
■ Clearing a DTMF memory	119
■ Confirming a DTMF memory	120
■ Setting DTMF transfer speed	120
■ Tone frequency and DTCS code	121
■ Digital code and digital call sign setting	122
■ Tone/DTCS squelch	124
■ Digital code/digital call sign squelch	124
■ Pocket beep function	125
■ DTCS polarity setting	125
■ Tone scan	126
■ Beep tones	127
■ Dial speed acceleration	127
■ Key lock effect	127
■ Weather channel operation	128
■ Power save	129
■ Auto power OFF	130

1

2

3

4

5

6

7

8

9

10

11

12

13

14

15

16

TABLE OF CONTENTS

■ Auto power ON	130
■ Time-out timer	130
■ PTT lock	130
■ Font size	131
■ Display backlighting	131
■ LCD contrast	131
■ Cloning function	132
■ Resetting	133
14 TROUBLESHOOTING	134
15 SPECIFICATIONS	135–136
16 OPTIONS	137–139
■ Optional HM-75A REMOTE CONTROL SPEAKER MICROPHONE	138
■ Connecting to the [DATA/SP/MIC] jack	139
INDEX	140–145

■ Antenna

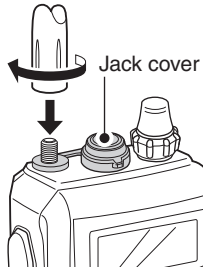

Insert the supplied antenna into the antenna connector and screw down the antenna as shown at left.

NEVER carry the transceiver by holding the antenna.

KEEP the jack cover attached when jack is not in use to protect the connector from dust and moisture.

✓ For your information

Third-party antennas may increase transceiver performance. An optional AD-92SMA ANTENNA CONNECTOR ADAPTER is available to connect an antenna with a BNC connector.

■ Belt clip

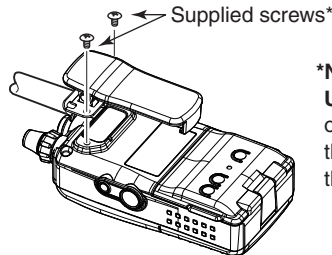

*NOTE:

USE the supplied screws only. Using screws longer than specified could damage the transceiver.

■ Hand strap

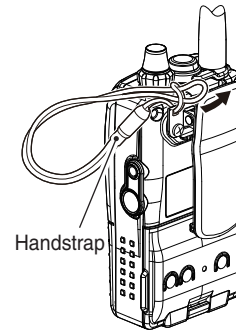

Slide the hand strap through the loop on the top of the belt clip as illustrated at left to facilitate carrying the transceiver.

■ Battery pack

Attach the Li-Ion battery pack (BP-256) or battery case (BP-257) as illustrated below.

- Charge the Li-Ion battery pack before use. (pgs. 10, 11)

Battery pack/Battery case

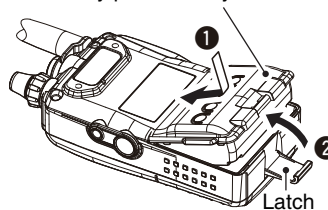

CAUTION!:

NEVER attach or detach the battery pack when wet.

Be careful when releasing the latch. Because the latch is tightly locked, don't use a finger nail to open it—you may injure yourself. Instead, use something relatively flat, like the edge of a coin or the tip of a screwdriver, to carefully release the latch.

■ Front, top and side panels

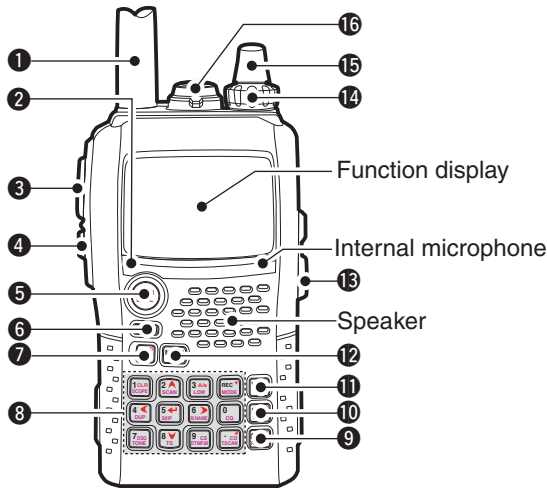

1 ANTENNA CONNECTOR (p. 1)

Connects the supplied antenna.

- An optional AD-92SMA adapter (p. 137) is available for connecting an antenna with a BNC connector.

2 TX/RX INDICATOR [TX/RX] (p. 24)

Lights green while receiving a signal or when the squelch is open; lights red while transmitting.

3 PTT SWITCH [PTT] (p. 24)

Push and hold to transmit, release to receive.

4 SQUELCH KEY [SQL]

- ➔ Push and hold to open the squelch temporarily and monitor the operating frequency. (p. 22)
- ➔ While pushing and holding this key, rotate [DIAL] to adjust the squelch level. (p. 21)

5 MAIN/DUAL KEY [MAIN/DUAL]

- ➔ Push to toggle the main band between A and B bands. (p. 26)
- ➔ Push and hold for 1 sec. to toggle the dualwatch function ON and OFF. (p. 25)

6 POWER KEY [PWR]

Push and hold for 1 sec. to turn the transceiver power ON and OFF. (p. 20)

7 BAND KEY [BAND]

- ➔ During VFO mode operation, push to select an operating frequency band. (pgs. 16, 17)
- ➔ During memory bank mode, push to select a memory bank. (p. 76)
- ➔ Enters or sends the DTMF code 'D'. (pgs. 117, 118)

8 KEYPAD (pgs. 4, 5)**9 CALL/RX→CS KEY [CALL]/[RX→CS](CALL)**

- ➔ Push to select the call channel/TV channel/weather channel. (pgs. 16, 28, 128)
- ➔ During DV mode operation, push and hold for 1 sec. to set the received call signs (station and repeaters) for operation. (p. 47)
- ➔ Enters or sends the DTMF code 'C'. (pgs. 117, 118)

10 MEMORY/SELECT MEMORY WRITE KEY [MR]/[S.MW](MR)

- ➔ Push to select memory mode. (p. 15)
- ➔ During memory mode operation, push to toggle between memory and memory bank mode. (p. 76)
- ➔ Push and hold for 1 sec. to enter select memory write mode. (p. 74)
- ➔ Enters or sends the DTMF code 'B'. (pgs. 117, 118)

11 VFO/MHz KEY [VFO]/[MHz](VFO)

- ➔ Push to toggle select VFO mode. (p. 15)
- ➔ During VFO mode operation, push and hold for 1 sec. to select and toggle 1 MHz and 10 MHz tuning steps. (p. 18)
- ➔ Enters or sends the DTMF code 'A'. (pgs. 117, 118)

12 MENU/LOCK KEY [MENU/LOCK]

- ➔ Push to toggle menu screen indication ON and OFF. (p. 93)
- ➔ Push and hold for 1 sec. to toggle the lock function ON and OFF. (p. 25)

13 EXTERNAL DC IN JACK [DC IN]

- ➔ Connects the supplied wall charger, BC-167A/D, to charge the attached battery pack. (p. 10)
- ➔ Connect an external DC power supply through the optional CP-12L, CP-19R or OPC-254L for external DC operation. (p. 13)

14 VOLUME CONTROL [VOL]

- ➔ Rotate to adjust the audio output level. (p. 20)

15 CONTROL DIAL [DIAL]

- ➔ Rotate to tune the operating frequency. (p. 18)
- ➔ During memory mode, rotate to select the memory channel. (pgs. 15, 72)
- ➔ While pushing and holding [BAND], selects the operating band in VFO mode. (p. 18)
- ➔ While scanning, changes the scanning direction. (p. 83)
- ➔ While pushing and holding [SQL], sets the squelch level. (p. 21)
- ➔ While pushing and holding [BAND], selects the programmed bank in memory mode. (p. 75)







/// The assigned function for [VOL] and [▲]/[▼] can be exchanged in initial set mode. (p. 99)







16 EXTERNAL SPEAKER/MICROPHONE JACK [DATA/SP/MIC]

- ➔ Connect a communication cable, optional speaker microphone or headset, if desired.
- See page 137 for a list of available options.

2 PANEL DESCRIPTION

◇ KEYPAD

KEY	Pushed momentarily	Pushed and held for 1 sec.
	<ul style="list-style-type: none"> Inputs digit '1' for frequency input, memory channel selection, etc. While pushing [PTT], this key sends the DTMF code "1." 	<ul style="list-style-type: none"> Displays the simple band scope for a single sweep. (p. 23) Displays the simple band scope for continuation sweep. (p. 23)
	<ul style="list-style-type: none"> Inputs digit '2' for frequency input, memory channel selection, etc. While pushing [PTT], this key sends the DTMF code "2." 	<ul style="list-style-type: none"> Starts a scan. (p. 83)
	<ul style="list-style-type: none"> Inputs digit '3' for frequency input, memory channel selection, etc. While pushing [PTT], this key sends the DTMF code "3." 	<ul style="list-style-type: none"> Toggles the transmit output power between high, mid, low and S-low (p. 24). <ul style="list-style-type: none"> While pushing and holding this key, with [DIAL] rotation selects the output power.
	<ul style="list-style-type: none"> Inputs digit '4' for frequency input, memory channel selection, etc. While pushing [PTT], this key sends the DTMF code "4." 	<ul style="list-style-type: none"> Activates the following duplex functions in order. <ul style="list-style-type: none"> Minus duplex operation— "-DUP" appears. Plus duplex operation— "+DUP" appears. Simplex operation— no duplex indicator appears. While pushing and holding this key, [DIAL] rotation selects the duplex function.
	<ul style="list-style-type: none"> Inputs digit '5' for frequency input, memory channel selection, etc. While pushing [PTT], this key sends the DTMF code "5." 	<ul style="list-style-type: none"> Turn the frequency skip function ON and OFF in VFO mode, or set the memory channel as the following skip channel in memory mode in order (p. 87). <ul style="list-style-type: none"> Skip channel— "SKIP" appears. Frequency skip channel— "PSKIP" appears. Non-skip channel— no skip indicator appears.
	<ul style="list-style-type: none"> Inputs digit '6' for frequency input, memory channel selection, etc. While pushing [PTT], this key sends the DTMF code "6." 	<ul style="list-style-type: none"> Turn the memory or bank name indication ON and OFF. (p. 78) Memory name (normal), memory name (large), bank name and OFF are selectable.

KEY	Pushed momentarily	Pushed and held for 1 sec.
	<ul style="list-style-type: none"> Inputs digit '7' for frequency input, memory channel selection, etc. While pushing [PTT], this key sends the DTMF code "7." 	<ul style="list-style-type: none"> During FM/FM-N mode operation, selects repeater tone, tone squelch, tone squelch reverse, DTCS squelch, DTCS squelch reverse and no tone operation in sequence. (p. 124) During DV mode operation, selects digital call sign squelch, digital code squelch and no squelch operation in sequence. (p. 124)
	<ul style="list-style-type: none"> Inputs digit '8' for frequency input, memory channel selection, etc. While pushing [PTT], this key sends the DTMF code "8." 	<ul style="list-style-type: none"> Selects tuning step selection. (p. 18)
	<ul style="list-style-type: none"> Inputs digit '9' for frequency input, memory channel selection, etc. While pushing [PTT], this key sends the DTMF code "9." 	<ul style="list-style-type: none"> Select DTMF memory mode. (p. 117) (Push and hold for 2 sec. while operating DV mode.) During DV mode operation, CALL SIGN setting mode is displayed. (pgs. 38, 48)
	<ul style="list-style-type: none"> Inputs digit '0' for frequency input, memory channel selection, etc. While pushing [PTT], this key sends the DTMF code "0." 	<ul style="list-style-type: none"> During DV mode operation, set "CQCQCQ" for station's call sign for operation.
	<ul style="list-style-type: none"> Inputs MHz digit for frequency input. While pushing [PTT], this key sends the DTMF code "F (#)." 	<ul style="list-style-type: none"> During FM/FM-N mode operation, starts tone scan function. (p. 126) During DV mode operation, RX CALL SIGN is displayed. (p. 46)
	<ul style="list-style-type: none"> During DV mode operation, selects the record track for voice memory. (p. 66) While pushing [PTT], this key sends the DTMF code "E (*)." 	<ul style="list-style-type: none"> Selects the operating mode. (p. 21)

■ Function display

• Single band indication

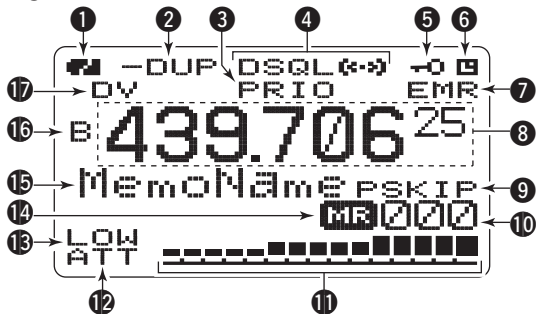

• Dualwatch indication

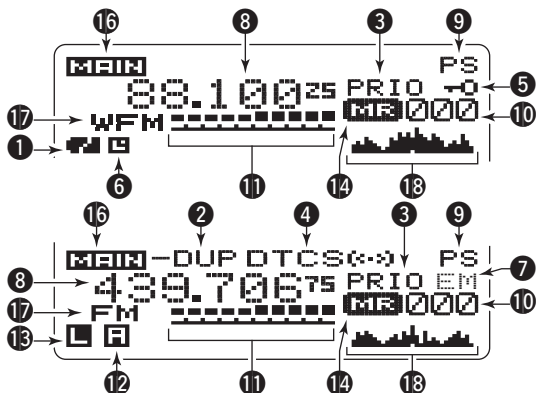

① BATTERY INDICATOR (pgs. 10, 12)

- ➔ “” (battery indicators) appear when the battery pack is attached.
- ➔ “” appears when the battery cells/pack must be changed/charged.
- ➔ The indicators show “,” “” and “” in sequence while charging the attached battery pack.

② DUPLEX INDICATOR (p. 29)

- ➔ “+DUP” appears when plus duplex, “-DUP” appears when minus duplex is selected.

③ PRIORITY WATCH INDICATOR (p. 90)

- ➔ Appears when priority watch is in use.

④ TONE INDICATOR

• While operating in FM/FM-N mode;

- ➔ “TONE” appears while the subaudible tone encoder is in use. (pgs. 29, 124)
- ➔ “TSQL” appears while the tone squelch function is in use. (p. 124)
- ➔ “TSQL R” appears while the reverse tone squelch function is in use. (p. 124)
- ➔ “DTCS” appears while the DTCS squelch function is in use. (p. 124)
- ➔ “DTCS R” appears while the reverse DTCS squelch function is in use. (p. 124)
- ➔ “((•))” appears with the “TSQL” or “DTCS” indicator while the pocket beep function (with CTCSS or DTCS) is in use. (p. 125)

- **While operating in DV mode;**
 - “DSQL” appears while the digital call sign squelch function is in use. (p. 124)
 - “CSQL” appears while the digital code squelch function is in use. (p. 124)
 - “(••)” appears with the “DSQL” or “CSQL” indicator while the pocket beep function (with digital call sign or digital code squelch) is in use. (p. 125)
- 5 KEY LOCK INDICATOR** (pgs. 25, 127)
Appears when the key lock function is activated.
- 6 AUTO POWER OFF INDICATOR** (p. 96)
Appears when the auto power OFF function is in use.
- 7 EMR/BK MODE INDICATOR** (pgs. 51, 56, 107)
 - Appears “EMR” when the EMR mode operation is selected. (p. 56)
 - Appears “BK” when the break-in communication is selected. (pgs. 51, 107)
- 8 FREQUENCY READOUT**
Displays a variety of information, such as operating frequency, set mode contents, memory names.
 - The decimal point blinks during scan.
- 9 SKIP INDICATOR** (pgs. 87, 88)
 - “SKIP” appears when the selected memory channel is set as a skip channel.
 - “PSKIP” appears when the displayed frequency is set as a skip frequency.
- 10 MEMORY CHANNEL NUMBER INDICATOR**
 - Shows the selected memory channel number. (pgs. 72, 73)
 - “C” appears when the call channel is selected. (pgs. 16, 73)
 - “WX” appears when the weather channel is selected. (pgs. 16, 128)
 - “TV” appears when the TV channel is selected. (pgs. 16, 28)
- 11 S/R F METER**
 - Shows the relative signal strength while receiving signals.
 - Shows the output power level while transmitting. (p. 24)
- 12 ATTENUATOR INDICATOR** (p. 22)
Appears when the RF attenuator is in use.
- 13 POWER INDICATOR** (p. 24)
 - “LOW” appears when low power is selected.
 - “SLO” appears when S-low power is selected.
 - “MID” appears when middle power is selected.
 - No indicator appears when high power is selected.
- 14 MEMORY INDICATOR** (p. 72)
Appears when memory mode is selected.
- 15 NAME INDICATOR** (p. 78)
During memory mode operation, the programmed memory or memory bank name is displayed.
- 16 MAIN BAND INDICATOR** (p. 14)
Shows which operating band, “A” or “B,” is selected for the main band.
- 17 OPERATING MODE INDICATOR** (p. 21)
Shows the selected operating mode.
 - DV, FM, FM-N, WFM and AM are available, depending on operating band.

■ Caution

Misuse of Lithium-Ion batteries may result in the following hazards: smoke, fire, or the battery may rupture. Misuse can also cause damage to the battery or degradation of battery performance.

- ⚠ **DANGER!** Use and charge only specified Icom battery packs with Icom radios. Only Icom battery packs are tested and approved for use with Icom radios. Using third-party or counterfeit battery packs may cause smoke, fire, or cause the battery to burst.
- ◇ **Battery caution**
 - ⚠ **DANGER! DO NOT** hammer or otherwise impact the battery. Do not use the battery if it has been severely impacted or dropped, or if the battery has been subjected to heavy pressure. Battery damage may not be visible on the outside of the case. Even if the surface of the battery does not show cracks or any other damage, the cells inside the battery may rupture or catch fire.
 - ⚠ **DANGER! NEVER** use or leave battery pack in areas with temperatures above +60°C (+140°F). High temperature buildup in the battery, such as could occur near fires or stoves, inside a sun heated car, or in direct sunlight may cause the battery to rupture or catch fire. Excessive temperatures may also degrade battery performance or shorten battery life.
- ⚠ **DANGER! DO NOT** expose the battery to rain, snow, seawater, or any other liquids. Do not charge or use a wet battery. If the battery gets wet, be sure to wipe it dry before using.
- ⚠ **DANGER! NEVER** incinerate a used battery pack since internal battery gas may cause it to rupture, or may cause an explosion.
- ⚠ **DANGER! NEVER** solder the battery terminals, or **NEVER** modify the battery pack. This may cause heat generation, and the battery may burst, emit smoke or catch fire.
- ⚠ **DANGER!** Use the battery only with the transceiver for which it is specified. Never use a battery with any other equipment, or for any purpose that is not specified in this instruction manual.
- ⚠ **DANGER!** If fluid from inside the battery gets in your eyes, blindness can result. Rinse your eyes with clean water, without rubbing them, and see a doctor immediately.
- **WARNING!** Immediately stop using the battery if it emits an abnormal odor, heats up, or is discolored or deformed. If any of these conditions occur, contact your Icom dealer or distributor.
- **WARNING!** Immediately wash, using clean water, any part of the body that comes into contact with fluid from inside the battery.

- **WARNING! NEVER** put the battery in a microwave oven, high-pressure container, or in an induction heating cooker. This could cause a fire, overheating, or cause the battery to rupture.
- **CAUTION!** Always use the battery within the specified temperature range, -20°C to $+60^{\circ}\text{C}$ (-4°F to $+140^{\circ}\text{F}$). Using the battery out of its specified temperature range will reduce the battery's performance and battery life.
- **CAUTION!** Keep the battery back below temperature range conditions while non use for a long time.
 - -20°C (-4°F) to $+45^{\circ}\text{C}$ ($+113^{\circ}\text{F}$) (within a month).
 - -20°C (-4°F) to $+35^{\circ}\text{C}$ ($+95^{\circ}\text{F}$) (within three months).
 - -20°C (-4°F) to $+25^{\circ}\text{C}$ ($+77^{\circ}\text{F}$) (More than a year).
- **CAUTION!** Shorter battery life could occur if the battery is left fully charged, completely discharged, or in an excessive temperature environment (above $+45^{\circ}\text{C}$; $+113^{\circ}\text{F}$) for an extended period of time. If the battery must be left unused for a long time, it must be detached from the radio after discharging. You may use the battery until the battery indicator shows half-capacity, then keep it safely in a cool dry place with the temperature between -20°C to $+25^{\circ}\text{C}$ (-4°F to $+77^{\circ}\text{F}$).

NOTE: When the desktop charger's charging indicator blinks orange for 10 sec. since the battery pack (with the transceiver) to the charger, charge the BP-256 only (without the transceiver), or charge the battery pack regularly (using with the battery charger, cigarette lighter cable, etc.).

◇ Charging caution

- **⚠ DANGER! NEVER** charge the battery pack in areas with extremely high temperatures, such as near fires or stoves, inside a sun heated car, or in direct sunlight. In such environments, the safety/protection circuit in the battery will activate, causing the battery to stop charging.
- **WARNING! DO NOT** charge or leave the battery in the battery charger beyond the specified time for charging. If the battery is not completely charged by the specified time, stop charging and remove the battery from the battery charger. Continuing to charge the battery beyond the specified time limit may cause a fire, overheating, or the battery may rupture.
- **WARNING! NEVER** insert the transceiver (battery attached to the transceiver) into the charger if it is wet or soiled. This could corrode the battery charger terminals or damage the charger. The charger is not waterproof.
- **CAUTION! DO NOT** charge the battery outside of the specified temperature range: 0°C to $+40^{\circ}\text{C}$ ($+32^{\circ}\text{F}$ to $+104^{\circ}\text{F}$). Icom recommends charging the battery at $+25^{\circ}\text{C}$ ($+77^{\circ}\text{F}$). The battery may heat up or rupture if charged out of the specified temperature range. Additionally, battery performance or battery life may be reduced.

3 BATTERY CHARGING

■ Regular charging

Prior to using the transceiver for the first time, the battery pack must be fully charged for optimum life and operation.

◇ Battery indicators

The indicators show “,” “” and “” in sequence while charging (the transceiver’s power OFF), and indicators disappear when completely charged.

◇ Charging note

- Be sure to turn the transceiver power OFF. Otherwise the battery pack will not be charged completely or takes longer to charge time periods.
- External DC power operation becomes possible when using an optional CP-12L, CP-19R or OPC-254L. The attached battery pack is also charged simultaneously, except during transmit. (see p. 11 for more details)
- The external DC power supply voltage must be between 10 –16 V to charge the battery pack and for operation when using an optional OPC-254L.

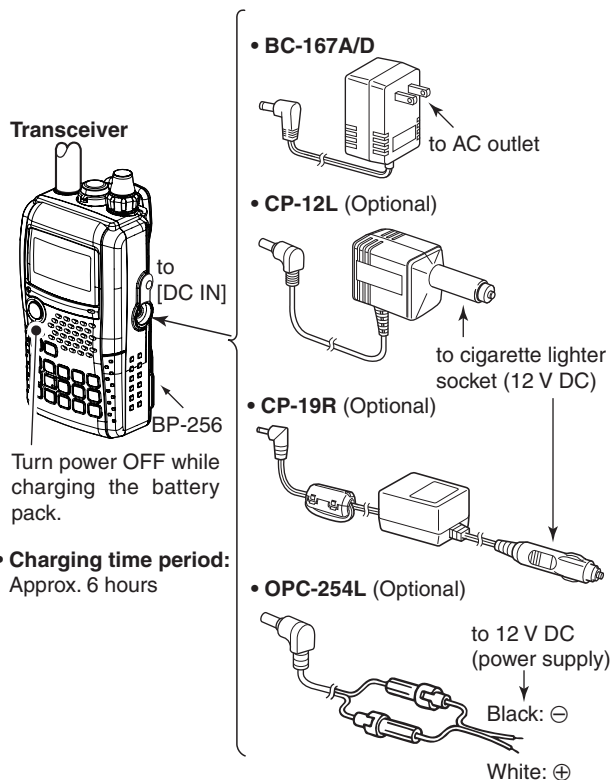

■ Rapid charging

The optional BC-177 provides rapid charging of the battery pack.

- **Charging period:** approx. 2.5 hours (with BP-256)

◇ Charging note

- Be sure to turn the transceiver power OFF.
Detach the battery pack from the transceiver then charge the battery pack by itself, or charge the battery with regular charging when the transceiver power cannot be turned OFF. Otherwise the battery pack will not be charged (charging indicator on the BC-177 blinks orange about 10 sec. after the battery pack is installed in BC-177).
- The desktop charger, BC-177, can only charge BP-256 battery packs. Other types of rechargeable battery, Ni-Cd or Ni-MH cannot be charged.
- If the charging indicator blinks orange, there may be a problem with the battery pack, there may be a problem with the battery pack (or charger). In this case, the battery pack is charged alone (without the transceiver) or regular charge is carried out. Contact your dealer when the battery pack isn't charged.
- The optional CP-12L and OPC-254L can be used instead of the supplied AC adapter. Connect one of these to the [DC 13.5V] jack in this case.

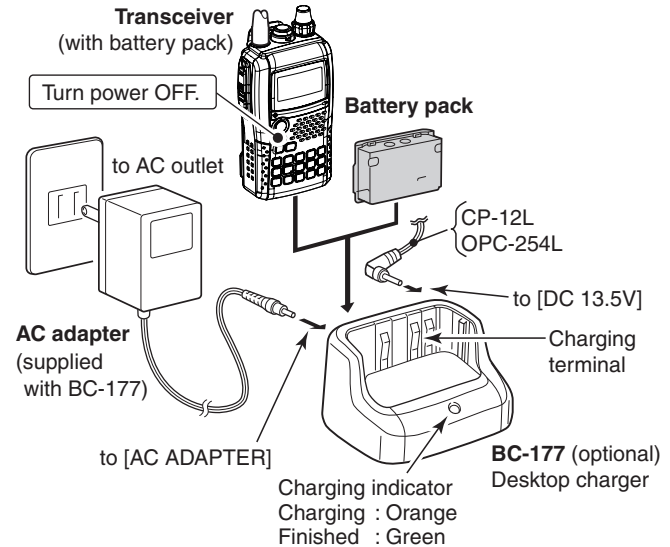

3 BATTERY CHARGING

■ Optional battery case

➔ Install 2 × LR6 (AA) size alkaline batteries into the optional BP-257 BATTERY CASE.

- Be sure to observe the correct polarity.

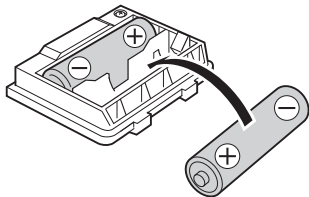

/// A built-in step-up convertor in the BP-257 increases the voltage to 5 V DC.

/// Approx. 100 mW of output power is possible with the BP-257 operation. Also, no transmit output power selection is available.

/// Keep battery contacts clean. It's a good idea to clean battery terminals once a week.

◇ Battery information

The batteries may seem to have low capacity when used in low temperatures such as -10°C ($+14^{\circ}\text{F}$) or below. Keep the battery case or pack warm in this case.

◇ Battery replacement

When the batteries become exhausted, the function display may blink or have a lower contrast. In these cases, replace all batteries with new, same brand, alkaline batteries.

■ Battery information

◇ Battery life

The transceiver operates with the BP-256 Li-ion as follows. However, when operating in DV mode, operating time may be shortened by one-half hour.

- **VHF band** : Approx. 6 hours
- **UHF band** : Approx. 5.5 hours (Tx: Rx: Stand-by=1: 1: 8)



/// Even when the transceiver power is OFF, a small current still flows in the radio. Remove the battery pack or case from the transceiver when not using it for a long time. Otherwise, the battery pack or installed batteries will become exhausted.

/// The battery protection function sets to S-Low (0.5 W) automatically while using 0°C ($+32^{\circ}\text{F}$). cally Transmit power selection is also disable.

◇ Battery indicator

The battery indicator, “,” appears only when the BP-256 Li-ion is attached to the transceiver.

/// The battery indicator does not appear when turning power ON after charging is completed without disconnecting the battery charger or external DC power.

Indication	Battery condition
	The battery has ample capacity.
	The battery is nearing exhaustion. Charging is necessary.

External DC power operation

An optional cigarette lighter cable (CP-12L or CP-19R; for 12 V cigarette lighter socket) or external DC power cable (OPC-254L) can be used for external power operation.

Operating note

- Power supply voltage must be between **10.0–16.0 V DC**. **NEVER CONNECT OVER 16 V DC** directly into the [DC IN] jack of the transceiver.
- **BE SURE** to use **CP-12L, CP-19R** or **OPC-254L** when connecting a regulated 12 V DC power supply.
- Use an external DC-DC converter to connect the transceiver through optional CP-12L, CP-19R or OPC-254L to a 24 V DC power source.
- The voltage of the external power supply must be within 10–16 V DC when using either CP-12L, CP-19R or OPC-254L, otherwise, use the battery pack.
- Disconnect the power cables from the transceiver when not using it. Otherwise, the vehicle battery will become exhausted.
- The power save function is deactivated automatically during external DC power operation.

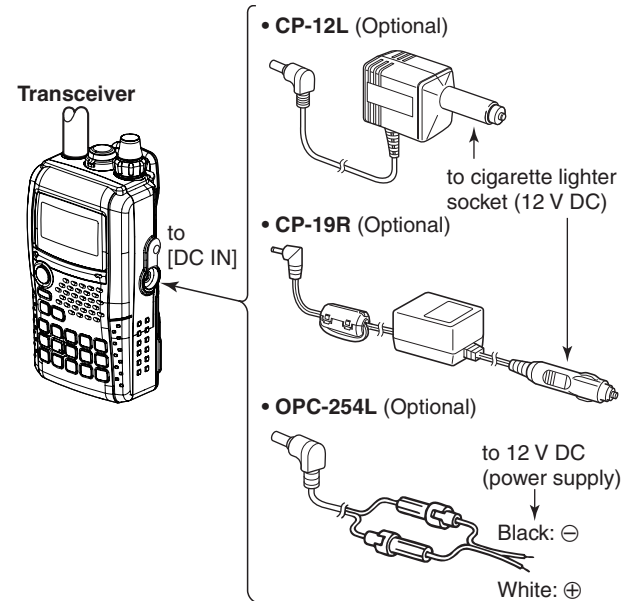

NOTE: Up to 5 W (approx.) of maximum output power is available when using external DC power. However, when the supplied voltage exceeds 14 V, the built-in protection circuit activates to reduce the transmit output power to 2.5 W (approx.).

■ Main band selection

The IC-92AD has two independent operating bands; A band (VFO A) and B band (VFO B). A band (VFO A) can operate 0.495 MHz to 999.990 MHz*, and B band (VFO B) can operate 118 MHz to 174 MHz and 350 MHz to 470 MHz.

*Some frequency ranges are blocked for the U.S.A. version by regulation.

NOTE: When in dualwatch mode, transmission is available on the MAIN band only.

◇ How to change the main band

- Push **[MAIN/DUAL]** to toggle between A and B band.
- Push and hold **[MAIN/DUAL]** for 1 sec. to turn the dualwatch operation ON and OFF.
 - While in dualwatch operation, the display indicates A band in the upper half and B band in the lower half.
- During dualwatch operation, push **[MAIN/DUAL]** to toggle between A band or B band as the main operating band.

Single band operation

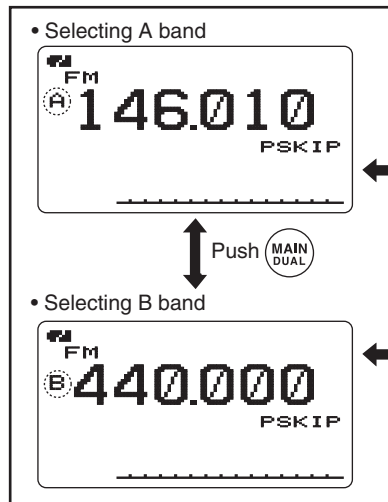

Dualwatch operation

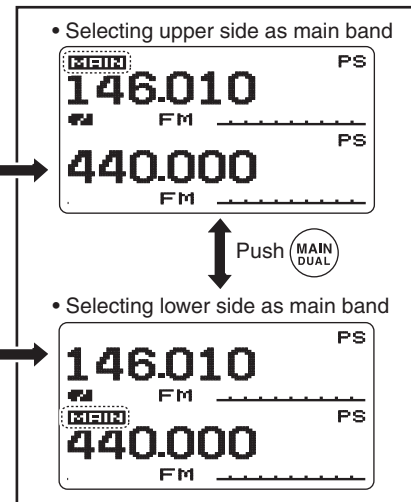

■ Mode selection

◇ VFO mode

VFO mode is used to set the desired frequency.

➔ Push **[VFO]** to select VFO mode.

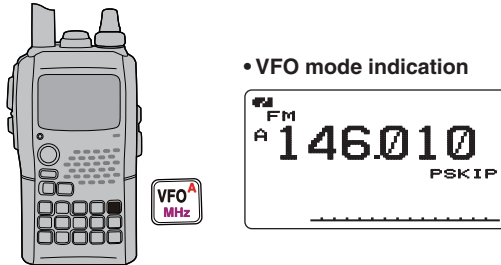

What is VFO?

VFO is an abbreviation of Variable Frequency Oscillator. Frequencies for both transmitting and receiving are generated and controlled by the VFO.

Set the attenuator function ON (p. 22) if the received signal is blocked by other radio station when using a third party high-gain antenna.

◇ Memory mode

Memory mode is used for operation on memory channels which store programmed frequencies.

- ① Push **[MR]** to select memory mode.
 - “**MR**” appears when memory mode is selected.

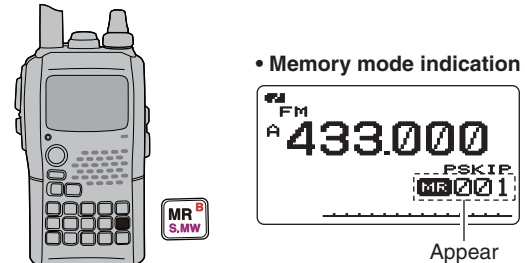

- ② Rotate **[DIAL]** to select the desired memory channel.
 - Only programmed memory channels can be selected.
 - Enter the memory channel directly to select the desired memory channel. (p. 72)
 - See p. 74 for memory programming details.

4 FREQUENCY AND CHANNEL SETTING

◇ Call/TV*/Weather† channels

Call channels are used for quick recall of most-often used frequencies.

- *Appears only when TV channels are programmed via the optional RS-92. Also available for A band operation only.
- †Available for the U.S.A. version only.

- ① Push **[CALL]** several times to select call channels/TV channels (A band only)/Weather channels.
 - Call/TV/Weather channels can be selected in sequence.

- ② Rotate **[DIAL]** to select the desired channel.

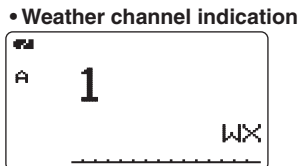
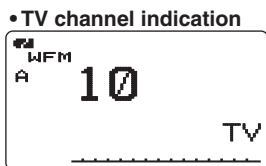
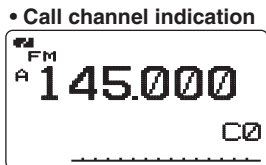
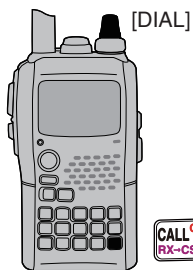

■ Operating band selection

The transceiver can receive the AM broadcast, HF bands, 50 MHz, FM broadcast, VHF air, 144 MHz, 300 MHz, 400 MHz or 800 MHz* bands. (Some bands are not selectable for B band operation. See next page for details.)

- ➔ In VFO mode, push **[BAND]** several times to select the desired frequency band.
- If VFO mode is not selected, such as a memory channel/call channel/TV channel/Weather channel, push **[VFO]** to select VFO mode first, then push **[BAND]** to select the desired band.
- ➔ While pushing and holding **[BAND]**, rotating **[DIAL]** also selects the frequency band.

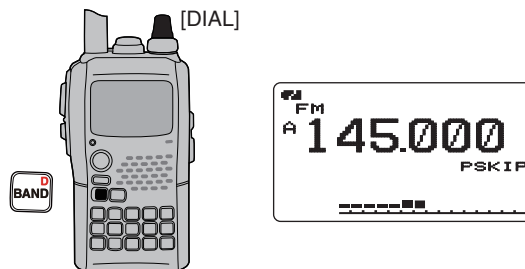

- Available frequency bands are different depending on version. See the specification for details. (pgs. 135, 136)
- *Some frequency ranges are blocked for the U.S.A. version by regulation.

• Available frequency bands

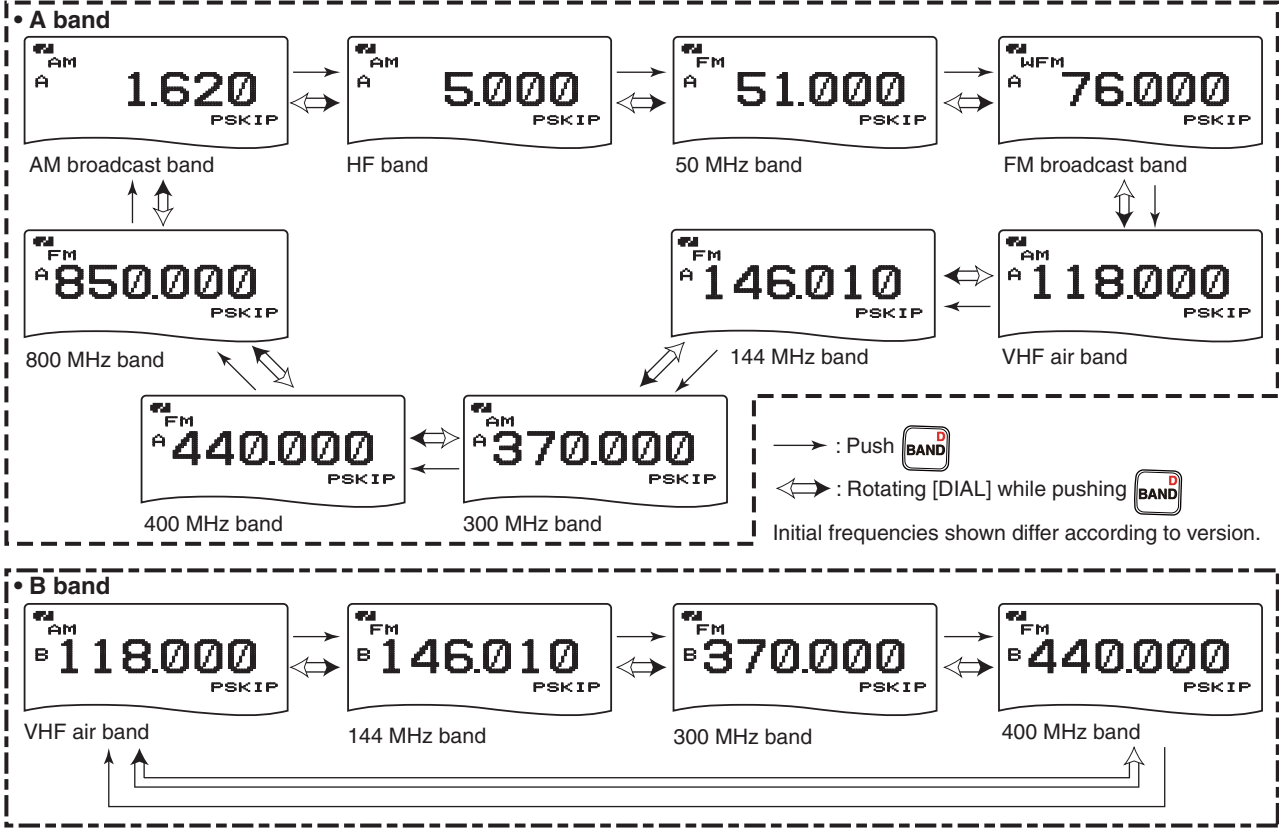

4 FREQUENCY AND CHANNEL SETTING

■ Setting a tuning step

The tuning step can be selected for each frequency band. The following tuning steps are available for the IC-92AD.

- 5.0 kHz* • 6.25 kHz* • 8.33 kHz† • 9.0 kHz‡ • 10.0 kHz
- 12.5 kHz • 15.0 kHz • 20.0 kHz • 25.0 kHz • 30.0 kHz
- 50.0 kHz • 100.0 kHz • 125.0 kHz • 200.0 kHz

* Appears for below the 600 MHz bands only.

† Appears for the VHF air band only.

‡ Appears for the AM broadcast band only.

◇ Tuning step selection

- ① Push **[VFO]** to select VFO mode, if necessary.
- ② Push **[BAND]** to select the desired frequency band.
 - Or, while pushing and holding **[BAND]**, rotate **[DIAL]** to select the desired frequency band.
- ③ Push and hold **[TS](8)** for 1 sec. to enter tuning step set mode.
 - While pushing and holding **[TS](8)**, rotate **[DIAL]** is also available to select tuning step.
- ④ Rotate **[DIAL]** to select the desired tuning step.
- ⑤ Push **[TS](8)** (or **[VFO]**) to return to VFO mode.

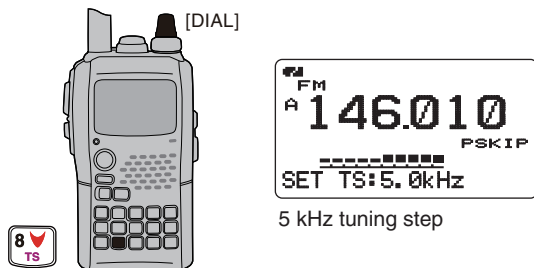

■ Setting a frequency

◇ Using the dial

- ① Push **[VFO]** to select VFO mode, if necessary.
- ② Select the desired frequency band with **[BAND]**.
 - Or, while pushing and holding **[BAND]**, rotate **[DIAL]** to select the desired frequency band.
- ③ Rotate **[DIAL]** to select the desired frequency.
 - The frequency changes according to the preset tuning steps. See the left-hand side of the page to set the tuning step.
 - Push and hold **[MHz](VFO)** for 1 sec. then rotate **[DIAL]** to change the frequency in 1 MHz steps, or push and hold for 1 sec. again then rotate **[DIAL]** to change the frequency in 10 MHz steps. (Each pushing and holding for 1 sec. toggles 1 MHz or 10 MHz tuning steps. Push **[MHz](VFO)** to cancel it.)

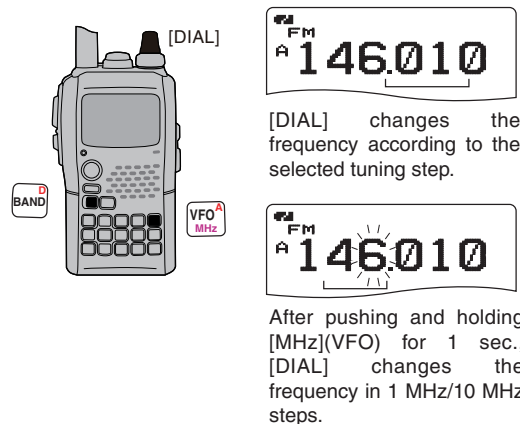

◇ Using the keypad

The frequency can be directly set via numeric keys.

• If a frequency outside the frequency range is entered, the previously displayed frequency is automatically recalled after editing last digit.

- ① Push [VFO] to select VFO mode, if necessary.
- ② Enter the desired frequency via the keypad.

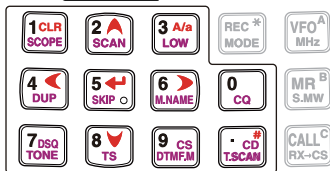

Depending on the tuning step setting, it may not be possible to input a 1 kHz digit. In this case, enter "0" as 1 kHz digit, then rotate [DIAL] to set the desired frequency.

• Entering 433.580 MHz

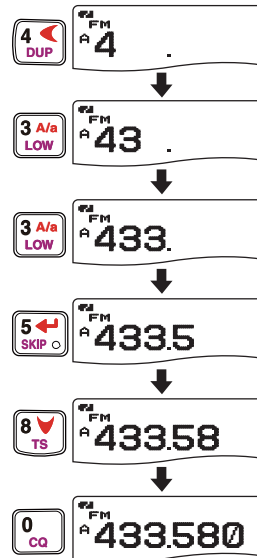

• Entering 80.200 MHz

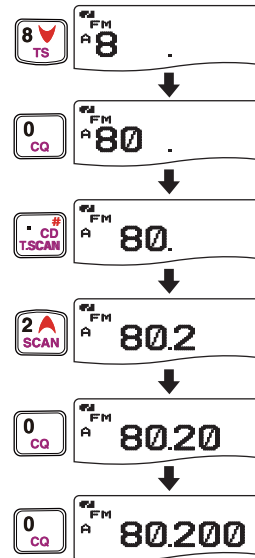

• Changing 100 kHz and below.

Editing 433.520 MHz to 433.140 MHz

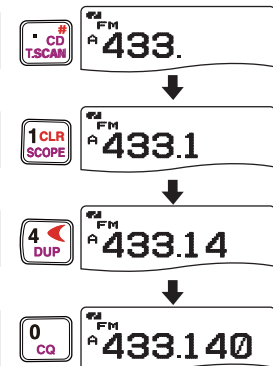

• Editing to 684 kHz



■ Receiving

Make sure a charged battery pack (BP-256) or brand new alkaline batteries (BP-257) are installed (pgs. 1, 12).

- ① Push and hold **[PWR]** for 1 sec. to turn power ON.
- ② Rotate **[VOL]** to set the desired audio level.
 - The frequency display shows the volume level while setting. See the section at right for details.
- ③ Set the receiving frequency. (p. 18)
- ④ Set the squelch level. (p. 21)
 - While pushing and holding **[SQL]**, rotate **[DIAL]**.
 - The first click of **[DIAL]** indicates the current squelch level.
 - “LEVEL 1” is loose squelch (for weak signals) and “LEVEL 9” is tight squelch (for strong signals).
 - “AUTO” indicates automatic level adjustment by a noise pulse counting system.
 - Push and hold **[SQL]** to open the squelch manually.
- ⑤ When a signal is received:
 - Squelch opens and audio is output.
 - The S/RF-meter shows the relative signal strength level.

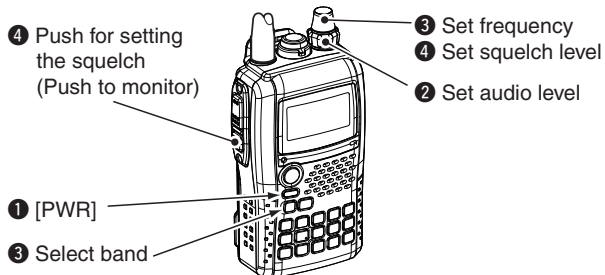

■ Setting audio volume

Rotate **[VOL]** to adjust the audio level.

- If squelch is closed, push and hold **[SQL]** while setting the audio level.
- The display shows the volume level while setting.

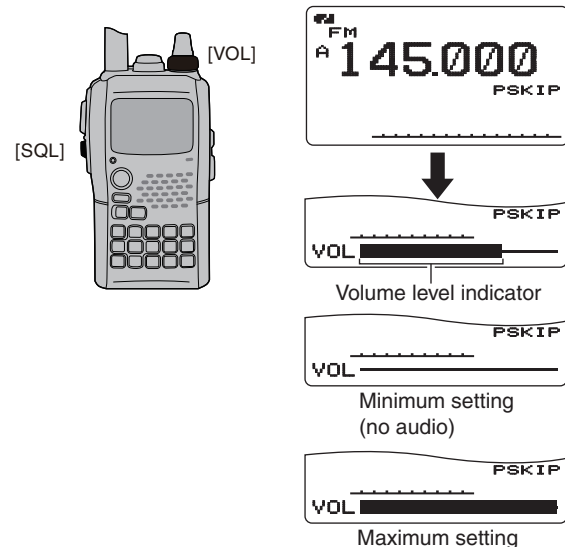

■ Setting squelch level

The squelch circuit mutes the received audio signal depending on the signal strength. The receiver has 9 squelch levels, a continuously open setting and an automatic squelch setting.

- ➔ While pushing and holding **[SQL]**, rotate **[DIAL]** to select the squelch level.
 - “LEVEL 1” is loose squelch (for weak signals) and “LEVEL 9” is tight squelch (for strong signals).
 - “AUTO” indicates automatic level adjustment by a noise pulse counting system.
 - “OPEN” indicates continuously open setting.

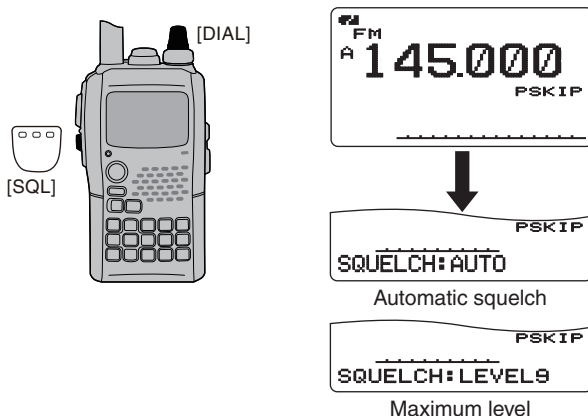

■ Operating mode selection

Operating modes are determined by the modulation of the radio signals. The transceiver has total 5 operating modes (A band: FM, WFM and AM modes, B band FM, FM-N, AM and DV modes). The mode selection is stored independently for each band and memory channel.

Typically, AM mode is used for the AM broadcast stations (0.495–1.620 MHz) and air band (118–136.995 MHz), and WFM is used for FM broadcast stations (76–107.9 MHz). WFM mode cannot be selected above 810 MHz for U.S.A. version.

- ➔ Push and hold **[MODE](REC)** for 1 sec. several times to select the desired operating mode.
 - While pushing and holding **[MODE](REC)**, rotate **[DIAL]** is also available to select operating mode.

• Display example

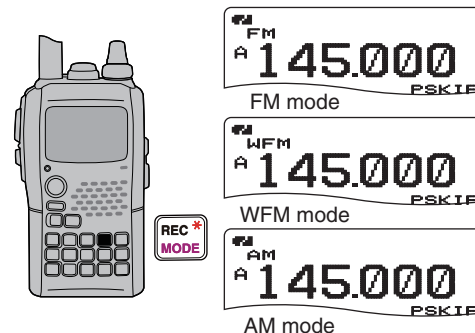

5 BASIC OPERATION

■ Monitor function

This function is used to listen to weak signals without disturbing the squelch setting or to open the squelch manually even when mute functions such as the tone squelch are in use.

- Push and hold **[SQL]** to monitor the operating frequency.
 - The 1st segment of the S-meter blinks.

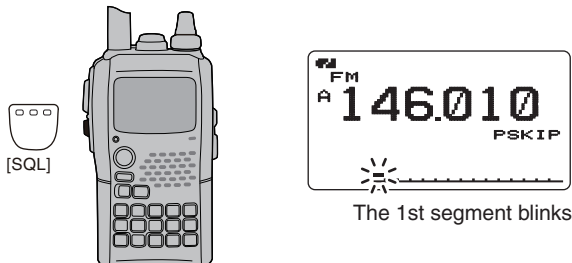

▨ The **[SQL]** key can be set to 'sticky' operation in set mode.
▨ See page 97 for details.

■ Attenuator function

The attenuator prevents distortion of a desired signal by very strong signals near the desired frequency or when very strong electric fields, such as from a broadcasting station, are present at your location. The attenuation is about 10 dB.

- ① Enter "ATTENUATOR" in set mode. (p. 96)

◀MENU screen▶ ↔ ▶SET MODE▶ ↔ ▶ATTENUATOR▶
(Push **[MENU/↔]**) (Rotate **[DIAL]**†, then push **[↔](5)**‡.)

- ② Rotate **[DIAL]**† to select "ON" or "OFF."
- ③ Push **[↔](5)** (or **[↔](4)**) to return to set mode, and push **[MENU/↔]** to return to frequency indication.
 - "ATT" appears on the function display when "ON" is selected.

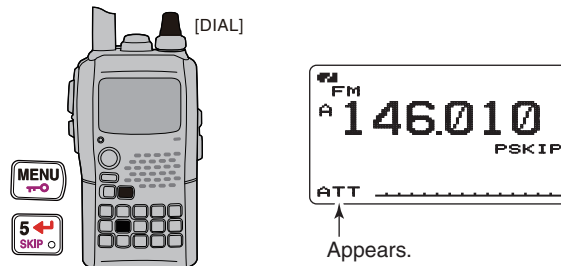

†[DIAL] ↔ [A](2)/[M](8)

‡[↔](5) ↔ [▶](6)

■ Band scope

The band scope function allows you to visually check a specified frequency range around the center frequency.

/// **About the sweep steps:** The specified tuning step in each frequency band (in VFO mode) or programmed tuning step (in memory mode) is used during sweep.

• Single watch mode display

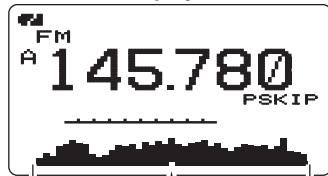

Band scope indication Sweep marker

◇ Single sweep

- ① Set the desired frequency as band scope center frequency.
 - Push **[MAIN/DUAL]** to select “MAIN band” during dual watch.
- ② Push and hold **[SCOPE](1)** for 1 sec. to start a single sweep.
 - 1 short and 1 long beeps sound.
 - Signal conditions (strengths) appear starting from the left of the range.
- ③ Rotate **[DIAL]** to set the highlighted cursor to the desired signal and set the frequency of the signal.
- ④ Push **[VFO]** to return to normal operation.

◇ Continuous sweep

- ① Set the desired frequency as band scope center frequency.
 - Push **[MAIN/DUAL]** to select “MAIN band” during dual watch.
- ② Push and hold **[SCOPE](1)** for 3 sec. to start continuous sweep.
 - 2 short beeps sound after 1 short and 1 long beeps.
 - Signal conditions (strengths) appear starting from the left of the range.
- ③ Push and hold **[SCOPE](1)** for 1 sec. to cancel sweep.
 - Pushing **[SQL]** also cancels sweep.
- ④ Push **[VFO]** to return to normal operation.

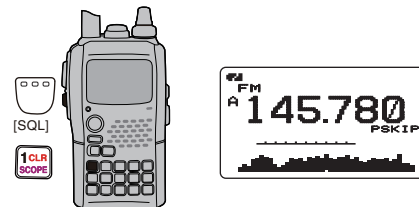

- The receive audio during sweeping can be muted in sounds set mode. See p. 115 for details.
- We recommend setting the tuning step to less than 20 kHz when using band scope function.
- Even if a strong signal is present, it may not be displayed on the band scope if the tuning step is set to wide (ex. 125 kHz, 200 kHz, etc)
- The display frequency's audio sounds for single watch operation within 118–174MHz and 350–470MHz regardless “Scope AF Output” setting in the MENU screen.
- If ghost waveform or audio appear, operate follow to avoid those. “tuning step changing,” “selecting dualwatch,” or “changing non sweep frequency if dualwatch operating”.

5 BASIC OPERATION

■ Transmitting

CAUTION: Transmitting without an antenna will damage the transceiver.

NOTE: To prevent interference, listen on the channel before transmitting by pushing and holding [SQL].

- ① Set the operating frequency.
(pgs. 18, 19)
 - Transmission is available on the 144 MHz/440 MHz amateur bands only.
 - Select output power if desired. See the section at right for details.
- ② Push and hold [PTT] to transmit.
 - Tx/Rx indicator lights red.
 - S/R/F meter shows the output power level.
- ③ Speak into the microphone using your normal voice level.
 - DO NOT hold the transceiver too close to your mouth or speak too loudly. This may distort your speech.
- ④ Release [PTT] to return to receive.

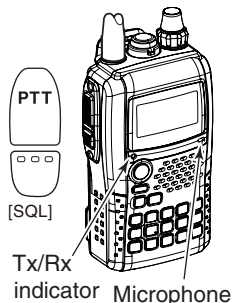

■ Transmit power selection

The transceiver has four output power levels to suit your operating requirements. S-Low output power during short-range communications may reduce the possibility of interference to other stations and will reduce current consumption.

➔ Push and hold [LOW](3) for 1 sec. to toggle the transmit output power between High (5W*), Mid (2.5 W*), Low (0.5 W*) and S-Low (0.1 W*).
*approx.

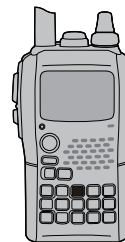

ONLY S-Low power operation is available while using BP-257.

While pushing and holding [MODE](REC), rotate [DIAL] is also available to select transmit power.

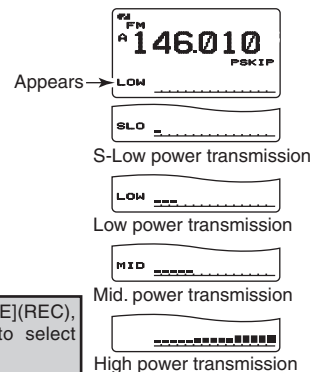

WARNING! NEVER continuously transmit for long periods of time. When the transceiver is used for continuous prolonged transmission at high power, the transceiver radiates heat to protect itself from overheating and transceiver's chassis will become hot. This may cause a burn.

DO NOT operate the transceiver in a situation that will obstruct heat dissipation, especially if the transceiver is operated with an external power supply. Heat dissipation may be affected, and it may cause a burn, warp the casing or damage the transceiver.

NOTE: Transmit power set 2.5 W (MID) automatically when the transceiver radiates heat.

CONNECT the rated range voltage when using external power supply.

■ Lock function

To prevent accidental frequency changes and unnecessary function access, use the lock function.

- ➔ Push and hold [MENU/🔒] for 1 sec. to turn the lock function ON and OFF.
 - “🔒” appears while the lock function is activated.
 - [PWR], [PTT] and [MENU/🔒] is operatable while the lock function is activated.
 - The squelch control and volume control can be used while the lock function is in use with default setting. Either or both the squelch control and volume control can also be locked in set mode. (pgs. 98, 127)

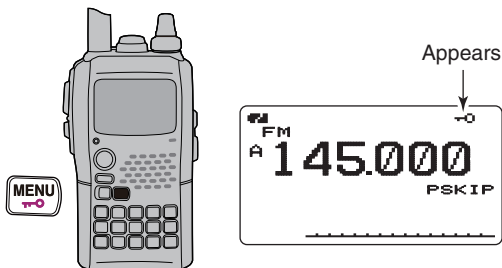

■ Dualwatch operation

Dualwatch operation monitors two frequencies simultaneously. The IC-92AD has two independent receiver circuits as A band and B band (available frequency bands and operating mode are different depending on bands).

◇ Dualwatch operation

- ➔ Push and hold [MAIN/DUAL] for 1 sec. to turn the dualwatch operation ON and OFF.
 - While in dualwatch operation, the display indicates A band in the upper side and B band in the lower side.

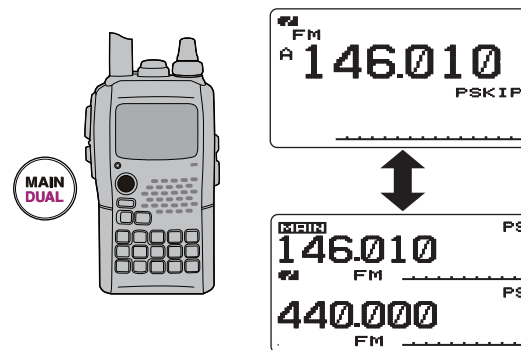

5 BASIC OPERATION

◇ Main band selection

- ➔ Push **[MAIN/DUAL]** to select upper side band or lower side band as the main operating band alternately.

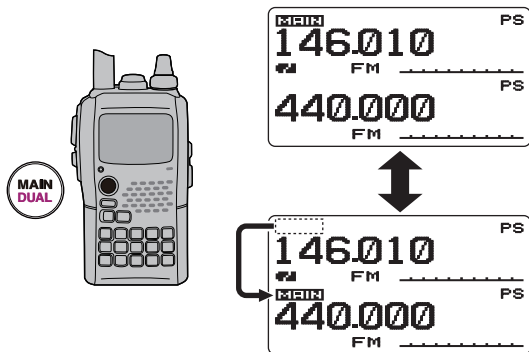

◇ Setting audio volume

The audio level for dualwatch operation can be adjusted both on upper side band and lower side band simultaneously (default).

This setting can be set separately for each band in sounds set mode.

- ① Push and hold **[MAIN/DUAL]** for 1 sec. to enter the dual-watch operation, if necessary.
- ② Rotate **[VOL]** to adjust the audio level for the main band.
 - If squelch is closed, push and hold **[SQL]** to verify the audio level.
 - The display shows the volume level while setting.

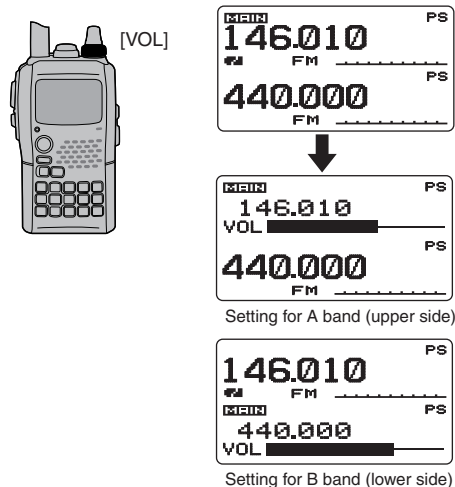

◇ Volume setting for dualwatch

The volume setting for dualwatch can be set for both bands simultaneously or for each band separately in set mode.

- ① Enter “VOLUME SELECT” in sounds set mode. (p. 115)
 <MENU screen> ⇄ <SOUNDS> ⇄ <VOLUME SELECT>
 (Push [MENU/LOCK]) (Rotate [DIAL]†, then push [←](5)‡.)
- ② Rotate [DIAL]† to select “BOTH” or “SEPARATE.”
- ③ Push [←](5) (or [↩](4)) to return to sounds set mode, and push [MENU/LOCK] to return to frequency indication.

◇ Setting squelch level

- ① Push and hold [MAIN/DUAL] for 1 sec. to enter the dual-watch operation, if necessary
- ② While pushing and holding [SQL], rotate [DIAL] to adjust the main band’s squelch level.
 - “LEVEL 1” is loose squelch and “LEVEL 9” is tight squelch.
 - “AUTO” indicates automatic level adjustment with a noise pulse count system.
 - “OPEN” indicates continuously open setting.

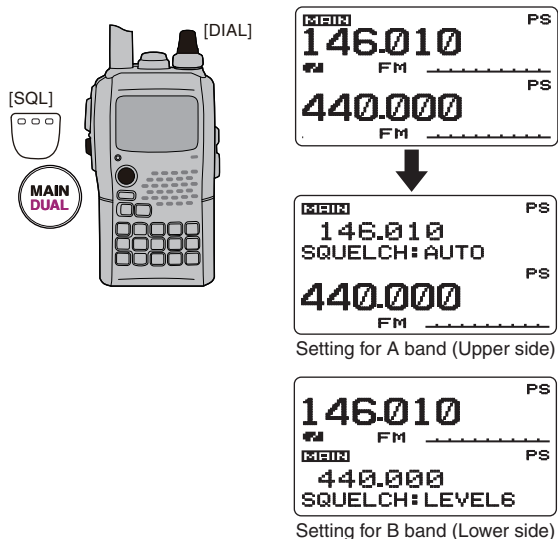

†[DIAL] ↔ [A](2)/[M](8) ‡[←](5) ↔ [→](6)

5 BASIC OPERATION

■ TV channel operation

TV channel operation is available only when TV channels are programmed using the optional RS-92. (p. 137) Also available for A band operation only.

◇ TV channel receiving

- ① Push **[CALL]** several times to select TV channels.
 - “TV” and channel number appear.
- ② Rotate **[DIAL]** to select the desired channel.
 - While pushing and holding **[BAND]**, rotating **[DIAL]** selects the all channels including skip channel.

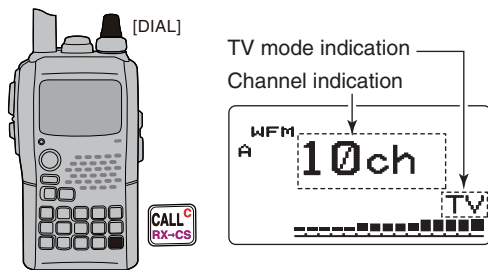

◇ Skip channel setting

Unwanted channels can be skipped for rapid selection, etc.

- ① Push **[CALL]** several times to select TV channels.
 - “TV” and channel number appear.

- ② Rotate **[DIAL]** to select the channel to be skipped.
 - To clear the skip setting, rotate **[DIAL]** while pushing and holding **[BAND]** to select a skip channel.
- ③ Push and hold **[SKIP](5)** for 1 sec. to toggle the skip setting ON and OFF.
 - “SKIP” appears when the channel is set as skip channel.

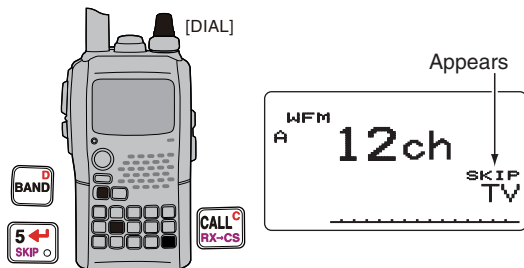

◇ Automatic TV channel programming

TV channels can be programmed automatically.

- ① Push **[CALL]** several times to select TV channels.
 - “TV” and channel number appear.
- ② Push **[SCAN](2)** to start TV channel programming.
 - The programming will automatically stop after scanning all channels.

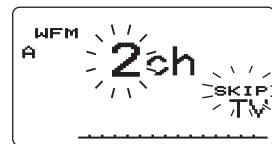

■ Repeater operation

When using a repeater, the transmit frequency is shifted from the receive frequency by the offset frequency. (p. 110)
This is called duplex operation. It is convenient to program repeater information into memory channels. (p. 74)

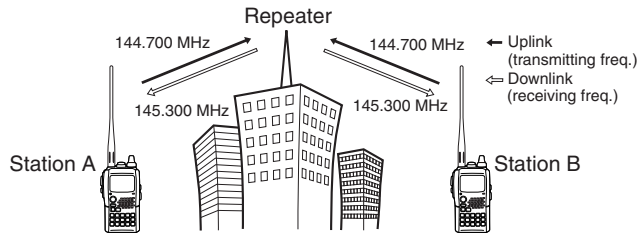

- ① Set the receive frequency (repeater output frequency).
- ② Set the shift direction of the transmit frequency. (-DUP or +DUP; see p. 31 for details.)
 - When the auto repeater function is in use (U.S.A. version only), this selection and step ③ are not necessary. (p. 32)

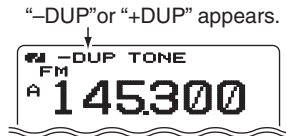

- ③ Push and hold **[TONE]**(7) for 1 sec. to activate the subaudible tone encoder, according to repeater requirements.

- “TONE” appears.

Refer to p. 121 for tone frequency settings.

- ④ Push and hold **[PTT]** to transmit.

- The displayed frequency automatically changes to the transmit frequency (repeater input frequency).
- If “OFF” appears, check the offset frequency or shift direction. (p. 30)

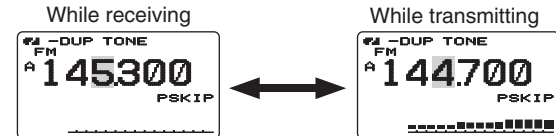

- ⑤ Release **[PTT]** to receive.
- ⑥ Push and hold **[SQL]** to check whether the other station's transmit signal can be directly received or not.

U.S.A. version:

Auto repeater function uses standard values of the repeater tone frequency and offset frequency.

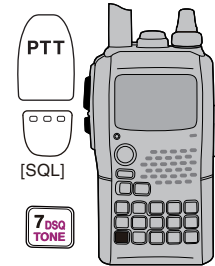

6 REPEATER AND DUPLEX OPERATIONS

◇ Checking the repeater input signal

The transceiver can check whether the other station's transmit signal can be received directly or not, by listening on the repeater input frequency.

- Push and hold **[SQL]** to check whether the other station's transmit signal can be received directly or not.
 - When the other station's signal can be directly received, move to a non-repeater frequency to use simplex. (duplex OFF)

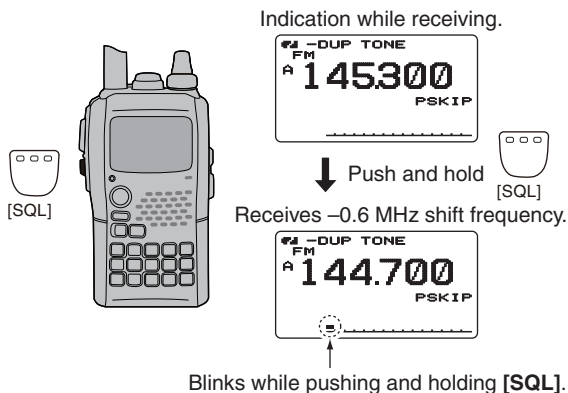

◇ Off band indication

If the transmit frequency is out of the amateur band, the off band indication, "OFF," appears on the display when **[PTT]** is pushed. Check the offset frequency or duplex direction in this case. (p. 31)

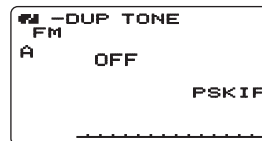

U.S.A. version:

Auto repeater function uses standard values of the offset frequency.

✓ CONVENIENT!

Tone scan function: When you don't know the subaudible tone used for a repeater, the tone scan is convenient for detecting the tone frequency.

- Push and hold **[T.SCAN](.)** for 1 sec. to start the tone scan. See p. 126 for more information.

Duplex operation

Although [DIAL] and [↔](5) are used for description in this section, [▲](2)/[▼](8) and [▶](6) are available instead of [DIAL] and [↔](5).

◇ Setting offset frequency

- Enter "OFFSET FREQ" in DUP/TONE... set mode. (p. 110)

⟨MENU screen⟩ ↔ ⟨DUP/TONE...⟩ ↔ ⟨OFFSET FREQ⟩
 (Push [MENU/↵]) (Rotate [DIAL][†], then push [↔](5)[‡].)

- Rotate [DIAL][†] to set offset frequency.
 - 1 MHz and 10 MHz tuning steps are available by pushing and holding [MHz](VFO) for 1 sec.: push [MHz](VFO) to cancel it.
- Push [↔](5) (or [◀](4)) to return to DUP/TONE... set mode, and push [MENU/↵] to return to frequency indication.

No offset frequency

OFFSET FREQ
0. 000. 00

5.0 MHz offset

OFFSET FREQ
5. 000. 00

◇ Setting duplex direction

- Push and hold [DUP](4) for 1 sec. to select "-DUP" (negative offset) or "+DUP" (positive offset).
 - "-DUP" or "+DUP" indicates the transmit frequency for minus shift or plus shift, respectively.

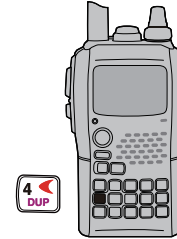

- When offset frequency is 0.6 MHz.

-Duplex example
Receiving

#1 -DUP TONE
FM
A 145300
PSKIP

Transmitting

#2 -DUP TONE
FM
A 144700
PSKIP

+Duplex example
Receiving

#1 +DUP TONE
FM
A 145300
PSKIP

Transmitting

#2 +DUP TONE
FM
A 145900
PSKIP

U.S.A. version:

Auto repeater function has priority over the manual duplex setting. If the transmit frequency changes after setting, the auto repeater function may have changed the duplex setting.

[†][DIAL] ↔ [▲](2)/[▼](8) [‡][↔](5) ↔ [▶](6)

6 REPEATER AND DUPLEX OPERATIONS

■ Auto repeater function

The U.S.A. version automatically use standard repeater settings (duplex ON/OFF, duplex direction, tone encoder ON/OFF) when the operating frequency falls within or outside of the general repeater output frequency range. The offset and repeater tone frequencies are not changed by the auto repeater function. Reset these frequencies, if necessary.

◇ Frequency range and offset direction

• U.S.A. version

FREQUENCY RANGE	SHIFT DIRECTION
145.200–145.495 MHz 146.610–146.995 MHz	“-DUP” appears
147.000–147.395 MHz	“+DUP” appears
442.000–444.995 MHz	“+DUP” appears
447.000–449.995 MHz	“-DUP” appears

U.S.A. version only

- ① Enter “AUTO RPT” in set mode. (p. 97)

◀MENU screen▶ ⇄ ▶SET MODE▶ ⇄ ▶AUTO RPT▶
(Push [MENU/↺]) (Rotate [DIAL]†, then push [↵](5)†.)

- ② Rotate [DIAL]† to select the auto repeater setting.
 - “RPT1” : Activates duplex only. (default)
 - “RPT2” : Activates duplex and tone.
 - “OFF” : Auto repeater function is turned OFF.
- ③ Push [↵](5) (or [↶](4)) to return to set mode, and push [MENU/↺] to return to frequency indication.

■ 1750 Hz tone

Some European repeaters require a 1750 Hz tone burst to be accessed. For such European repeaters, perform the following.

- This tone can be use as a 'Call signal' in countries out of Europe.
- ① Push and hold **[DTMF.M](.)** for 1 sec. to select DTMF memory.



- ② Rotate **[DIAL]**[†] counter-clockwise until "T-CALL" appears.
- ③ Push **[←](5)** to set.



- ④ Push **[VFO]** to exit DTMF memory.
- ⑤ Set the receive frequency (repeater output frequency).
- ⑥ Set the shift direction of the transmit frequency. (-DUP or +DUP; see p. 31 for details.)
- ⑦ While pushing **[PTT]**, push **[SQL]** to transmit a 1750 Hz tone burst signal.
 - If "OFF" appears, check the offset frequency or shift direction. (p. 110)
 - The displayed frequency automatically changes to the transmit frequency (repeater input frequency).

- ⑧ Push and hold **[PTT]** to transmit.
- ⑨ Release **[PTT]** to receive.
- ⑩ Push and hold **[SQL]** to check whether the other station's transmit signal can be received directly or not, by listening on the repeater input frequency.

[†][DIAL] ↔ **[▲](2)/[▼](8)** [‡][←](5) ↔ **[→](6)**

Although [DIAL] and [←](5) are used for description in this section, [▲](2)/[▼](8) and [▶](6) are available instead of [DIAL] and [←](5).

■ Digital mode operation

The IC-92AD can be operated in digital voice mode and low-speed data operation for both transmit and receive. It can also be connected to a GPS receiver (compatible with an RS-232 output/NMEA format/4800 bps/9600 bps) and transmit/receive position data.

■ Call sign programming

Four types of call sign memories are available; your own call sign “MY CALL SIGN,” other station call sign “YOUR CALL SIGN,” repeater call sign “RPT1 CALL SIGN” and “RPT2 CALL SIGN.” “MY CALL SIGN” can store up to 6 call signs, “YOUR CALL SIGN” can store up to 60 call signs and “RPT1/2 CALL SIGN” can store up to 60 call signs, and each call sign can be programmed with up to 8 characters.

◇ Your own call sign programming

Your own call sign must be programmed for both digital voice and low-speed data communications (including GPS transmission).

- ① Select B band as the main band. (p. 14)
- ② Enter “MY” in call sign set mode.

<MENU screen> ⇄ <CALL SIGN> ⇄ <MY>
(Push [MENU/🔑] (Rotate [DIAL]†, then push [←](5)†.)

- Pushing and holding [CS](9) for 1 sec. is also available to enter call sign set mode.
- MY CALL SIGN screen is displayed.

```

MY CALL SIGN
M01

←:SET      ▲▼:SEL
←:BACK    ▶:EDIT
          CLR:CLR
  
```

- ③ Rotate [DIAL]† to select the desired call sign memory, “M01” to “M06.”
- ④ Push [▶](6) to enter call sign programming mode.
 - The 1st digit blinks.

```

MY CALL SIGN
M01      AB

  [Blinking]

←:SET      CLR:CLR
▲▼:SEL    A/a:CHAR
←▶:CUR
  
```

- ⑤ Rotate [DIAL]† to select the desired character or code.
 - Push [A/a](3) to change the character group from “AB” (alphabetical characters; capital letters), “12” (numbers) and “/” (symbols) in sequence.

- ⑥ Push **[▶](6)** to select 2nd digit, then rotate **[DIAL]†** to select the desired character or code.
 - Push **[▶](6)** to move the cursor right; push **[◀](4)** to move the cursor left.
 - 2nd digit blinks (1st digit stops blinking).



- ⑦ Repeat the steps ⑤ and ⑥ to enter your own call sign.
 - Up to a 8-digit of call sign can be set.
 - If an unwanted character is entered, push **[▶](6)** or **[◀](4)** to select the character, then push **[CLR](1)** to erase the selected character, or push and hold **[CLR](1)** for 1 sec. to erase all characters following the cursor.
 - When programming a note (up to a 4-digit for operating radio type or area, etc.), go to step ⑧, otherwise go to step ⑩.
- ⑧ Push **[▶](6)** several times to set the cursor beside “/” indication.
- ⑨ Repeat steps ⑤ to ⑥ to program the desired 4-character note.

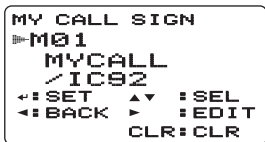

- ⑩ Push **[←](5)** to store the programmed call sign with note and returns to MY CALL SIGN screen.
- ⑪ Push **[MENU/▶-○]** to return to frequency indication.

†[DIAL] ↔ [▲](2)/[▼](8) ‡[←](5) ↔ [▶](6)

7 DV MODE OPERATION

◆ Station call sign programming

Station call sign must be programmed to call a specific station as well as for repeater operation in both digital voice and low-speed data communications.

- ① Select B band as the main band. (p. 14)
- ② Enter "UR" in call sign set mode.

<MENU screen> ⇨ <CALL SIGN> ⇨ <UR>
(Push **[MENU/⇨]**) (Rotate **[DIAL]**†, then push **[←](5)**†.)

- Pushing and holding **[CS](9)** for 1 sec. is also available to enter call sign set mode.
- YOUR CALL SIGN screen is displayed.

```
YOUR CALL SIGN
=U
CQCQCQ
+ : SET   ▲▼ : SEL
- : BACK  ▶ : EDIT
          CLR : CLR
```

- ③ Rotate **[DIAL]**† to select the desired call sign memory, "U01" to "U60."
 - ④ Push **[▶](6)** to enter call sign programming mode.
- The 1st digit blinks.

```
YOUR CALL SIGN
=U01 AB
+ : SET   CLR : CLR
▲▼ : SEL  A/a : CHAR
- : CUR   0 : CQ
```

- ⑤ Rotate **[DIAL]**† to select the desired character or code.
- Push **[A/a](3)** to change the character group from "AB" (alphabetical characters; capital letters), "12" (numbers) and "/" (symbols) in sequence.

- ⑥ Push **[▶](6)** to select 2nd digit, then rotate **[DIAL]**† to select the desired character or code.
- Push **[▶](6)** to move the cursor right; push **[←](4)** to move the cursor left.
 - 2nd digit blinks (1st digit stops blinking).

```
YOUR CALL SIGN
=UR1 AB
+ : SET   CLR : CLR
▲▼ : SEL  A/a : CHAR
- : CUR   0 : CQ
```

- ⑦ Repeat the steps ⑤ and ⑥ to enter the desired station call sign.
- Up to an 8-digit call sign can be set.
 - If an un-necessary character is entered, push **[▶](6)** or **[←](4)** to select the character, then push **[CLR](1)** to erase the selected character, or push and hold **[CLR](1)** for 1 sec. to erase all characters following the cursor.

```
YOUR CALL SIGN
=U01
STATION1
+ : SET   ▲▼ : SEL
- : BACK  ▶ : EDIT
          CLR : CLR
```

- ⑧ Push **[←](5)** to store the programmed call sign and returns to YOUR CALL SIGN screen.
- ⑨ Push **[MENU/⇨]** to return to frequency indication.

NOTE: During the call sign programming mode (④ to ⑦), push **[CQ](0)** to set "CQCQCQ," and push **[CQ](0)** again to return to the previously stored call sign.

✓ For your information

The IC-92AD has a call sign edit record function.

When editing a call sign stored in a call sign memory, regular memory or call channel, the default setting is to store the edited call sign into a blank channel automatically. ("FULL" is displayed when all call sign memory is programmed.)

The edited call sign can be over-written when the setting of the EDIT RECORD is set to OFF or SELECT. (p. 106)

However, you must manually over-write a programmed call sign in regular memory and call channels. (Temporary operation without over-writing is possible.)

[DIAL] ↔ **[A](2)/[M](8)** †**[←](5) ↔ [→](6)**

■ Digital voice mode operation

- ① Set the desired frequency in B band. (pgs. 14, 18)
 - Select output power, if desired. (p. 24)
- ② Select DV mode. (p. 21)
- ③ Set your own call sign for DV operation as follows.
 - 1] Enter "MY" in call sign set mode.

<MENU screen> ⇨ <CALL SIGN> ⇨ <MY>
 (Push [MENU/PTT] (Rotate [DIAL]†, then push [←](5)‡.)

- Pushing and holding [CS](9) for 1 sec. is also available to enter call sign set mode.

- 2] Rotate [DIAL]† to select your own call sign (if you have programmed several call signs) then push [←](5) to set the call sign and return to CALL SIGN screen.
 - See page 34 for your own call sign programming details.

```

CALL SIGN
UR:
R1:
R2: NOT USE*
MY: MYCALL
  /IC92
    
```

- ④ Set the desired call sign as described in "When calling the desired station (p. 39)" or "When sending a CQ (p. 39)."
- ⑤ Push and hold [PTT] to transmit and speak into the microphone at normal voice level.
 - Tx/Rx indicator lights red and the RF meter shows the output power.

- ⑥ Release [PTT] to return to receive.
 - The other station's call sign will be received.
 - Received call signs can be stored into the received call record automatically. See page 101 for details.

NOTE: The digital mode operation is vastly different from FM mode. One of the differences is that in digital mode the squelch does not function as in FM mode. Changing the squelch setting will not open it to hear the hiss of "white noise." It only activates for digital squelch functions such as CSQL (Digital code squelch) or DSQL (Digital call sign squelch).

◇ When calling the desired station

Continued instruction from step 2 on page 38.

- 3 Rotate **[DIAL]**† to select “UR,” then push **[←](5)**†.
 - YOUR CALL SIGN screen is displayed.
- 4 Rotate **[DIAL]**† to select the call sign channel in which the desired station’s call sign is programmed.
 - See page 36 for station call sign programming details.
- 5 Push **[←](5)** to set the station’s call sign and return to CALL SIGN screen.

```
CALL SIGN
=UR: STATION1
R1:
R2: NOT USE*
MY: MYCALL
  /IC92
```

- 6 Push **[MENU/↵]** to return to frequency indication.
- 7 Perform the instruction steps 5 and 6 on page 38.

◇ When sending a CQ

Continued instruction from step 2 on page 38.

- 3 Rotate **[DIAL]**† to select “UR,” then push **[←](5)**†.
 - YOUR CALL SIGN screen is displayed.
- 4 Rotate **[DIAL]**† to select the call sign channel in which “CQCQCQ” is programmed.
 - Or, select “U” then push **[>](6)** and **[CQ](0)** in sequence to set “CQCQCQ.”
- 5 Push **[←](5)** to set “CQCQCQ” as the call sign and return to CALL SIGN screen.

```
CALL SIGN
=UR: CQCQCQ
R1:
R2: NOT USE*
MY: MYCALL
  /IC92
```

- 6 Push **[MENU/↵]** to return to frequency indication.
- 7 Perform the instruction step 5 and 6 on page 38.

†**[DIAL]** ↔ **[▲](2)/[▼](8)** ‡**[←](5)** ↔ **[>](6)**

■ About the D-STAR system

In the D-STAR system, repeater linking via a 10 GHz band backbone and internet network (gateway connection) capabilities are available. This system provides you with much wider coverage range during digital voice mode operation.

• D-STAR system outline

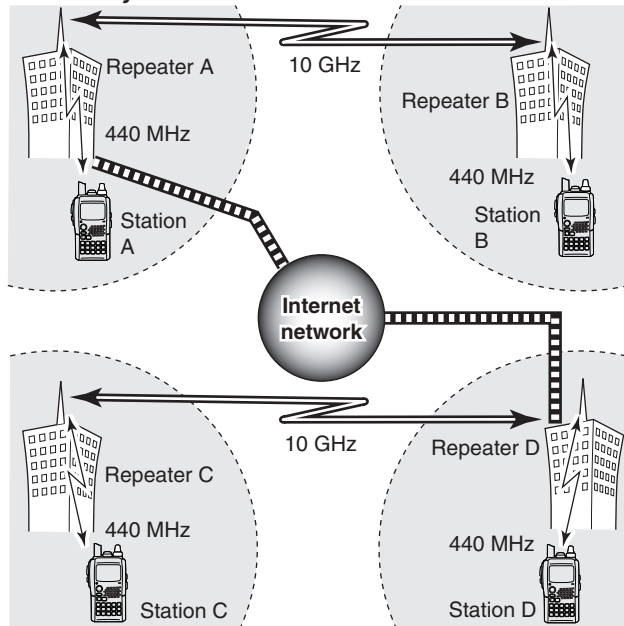

For current repeater operation, stations that are communicating must both be in the same repeater's operating area. However, in the D-STAR system as in the illustration at left, the repeaters can be linked via the system repeaters (with a 10 GHz signal). Thus stations A and B can communicate even though they are in different repeater operating areas.

Also, the D-STAR system repeaters are connectable through the internet— gateway connection capability.

For example, when station B uses the gateway connection station B can communicate with the station C! By using the gateway connection, long distance communication like DX operation may be possible with 144 or 440 MHz digital voice!

In the D-STAR system, an independent repeater's operating area is called an Area and a group that of linked repeaters via a 10 GHz backbone is called a Zone.

About time-out timer function

The IC-92AD has a time-out timer function for digital repeater operation. The timer limits a continuous transmission for approx. 10 min. Warning beeps will sound before 30 sec. (approx.) and just before the timer functioning.

■ Digital repeater operation

Repeater call signs must be programmed for repeater operation in both digital voice and low-speed data communications.

◇ Repeater call sign programming

- ① Select B band as the main band. (p. 14)
- ② Enter "R1" or "R2" in call sign set mode.

◀MENU screen▶ ↔ ▶CALL SIGN▶ ↔ ▶R1▶/▶R2▶
(Push [MENU/↻] (Rotate [DIAL]†, then push [↵](5)†.)

- RPT1 or RPT2 CALL SIGN screen is displayed.
 - Pushing and holding [CS](9) for 1 sec. is also available to enter call sign set mode.
- ③ Rotate [DIAL]† to select the desired call sign memory, "R01" to "R60."
 - ④ Push [▶](6) to enter call sign programming mode.
 - The 1st digit blinks.
 - ⑤ Rotate [DIAL]† to select the desired character or code.
 - Push [A/a](3) to change the character group from "AB" (alphabetical characters; capital letters), "12" (numbers) and "P" (symbols) in sequence.
 - Set "P" at the 1st digit then set the desired area repeater's call sign (in a different zone) for CQ call ("P" stands for "CQCQCQ") in a different zone operation. (p. 44)
 - ⑥ Push [▶](6) to select 2nd digit, then rotate [DIAL]† to select the desired character or code.
 - Push [▶](6) to move the cursor right; push [◀](4) to move the cursor left.
 - 2nd digit blinks (1st digit stops blinking).

- ⑦ Repeat the steps ⑤ and ⑥ to enter the desired repeater call sign.
 - Up to an 8-digit of call sign can be set.
 - Push [7] when setting with the gateway connection if the selected repeater has gateway capability. (The gateway connection can be set in RPT1 only when "NOT USE*" is set to RPT2.)
 - If an un-necessary character is entered, push [▶](6) or [◀](4) to select the character, then push [CLR](1) to erase the selected character, or push and hold [CLR](1) for 1 sec. to all characters following the cursor.

```

RPT1 CALL SIGN
▶R01
  RPT1AA G
◀:SET   ▲▼:SEL
◀:BACK ▶:EDIT
          CLR:CLR
  
```

- ⑧ Push [↵](5) to store the programmed call sign and returns to RPT1 or RPT2 CALL SIGN screen.
- ⑨ Push [MENU/↻] to return to frequency indication.

†[DIAL] ↔ [A](2)/[V](8) ‡[↵](5) ↔ [▶](6)

7 DV MODE OPERATION

◇ Repeater operation in the same zone

- ① Set the desired repeater's frequency, offset and shift direction in B band. (pgs. 18, 31)
 - Select DV mode in advance. (p. 21)
- ② Set your own call sign. (p. 38)
 - See p. 34 for your own call sign programming.
- ③ Set the desired station call sign. (p. 39)
 - See p. 36 for station call sign programming.
- ④ Set the repeater's call sign as follows;
 - 1 Enter "R1" in call sign set mode.

⟨MENU screen⟩ ⇄ ⟨CALL SIGN⟩ ⇄ ⟨R1⟩
(Push [MENU/↵] (Rotate [DIAL]†, then push [↵](5)†.)

- Pushing and holding [CS](9) for 1 sec. is also available to enter call sign set mode.

- 2 Rotate [DIAL]† to select the nearest repeater's call sign.
- 3 Push [↵](5) to set the call sign for "R1."
 - Return to CALL SIGN screen.
- 4 Rotate [DIAL]† to select "R2" then push [↵](5)†.
 - RPT2 CALL SIGN screen is displayed.
- 5 Rotate [DIAL]† to select the desired repeater's (in the same zone) call sign.
 - Select "NOT USE*" when not operating RPT2.
- 6 Push [↵](5) to set the call sign for "R2."
 - Return to CALL SIGN screen.

```
CALL SIGN
UR: CQCQCQ
R1: RPT1AA
R2: NOT USE*
MY: MYCALL
/IC92
```

- 7 Push [MENU/↵] to return to frequency indication.
- 5 Push [PTT] to transmit; release to receive.

†[DIAL] ⇄ [A](2)/[V](8) †[↵](5) ⇄ [D](6)

• Setting example 1

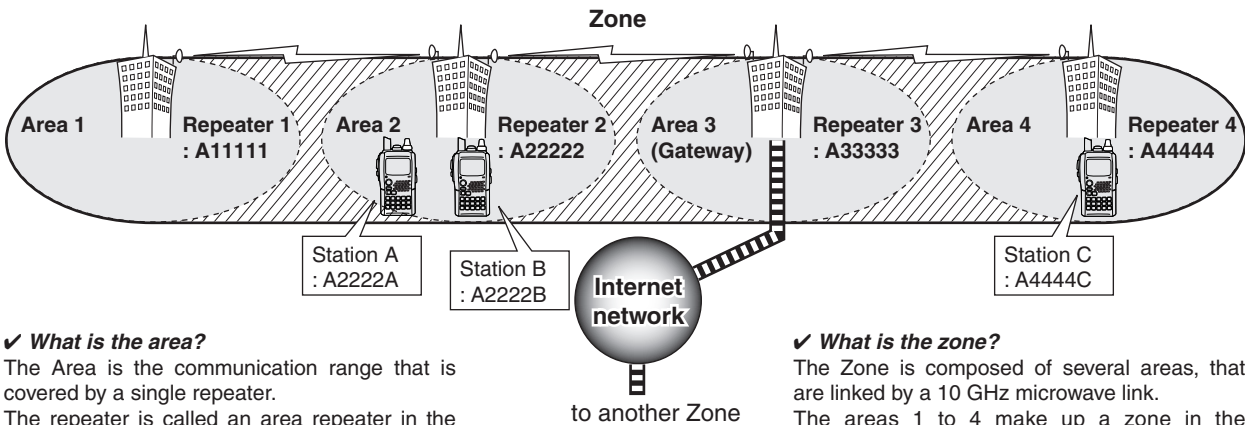

✓ *What is the area?*

The Area is the communication range that is covered by a single repeater. The repeater is called an area repeater in the D-STAR system.

✓ *What is the zone?*

The Zone is composed of several areas, that are linked by a 10 GHz microwave link. The areas 1 to 4 make up a zone in the example above.

The setting when Station A is calling Station B

- UR : A2222B
- R1 : A22222
- R2 : NOT USE*
- MY : A2222A

The setting when Station A is making a CQ call in Area 1

- UR : CQCQCQ
- R1 : A22222
- R2 : A11111
- MY : A2222A

The setting when Station A is calling Station C

- UR : A4444C
- R1 : A22222
- R2 : A44444
- MY : A2222A

7 DV MODE OPERATION

◇ Repeater operation into another zone

- ① Set the desired repeater's frequency, offset and shift direction in B band. (pgs. 18, 31)
 - Select DV mode in advance. (p. 21)
- ② Set your own call sign. (p. 38)
 - See p. 34 for your own call sign programming.
- ③ Set the desired station call sign. (p. 39)
 - **When making a CQ call**
Set the desired repeater's (in a different zone) call sign with a "/" symbol at the 1st digit, for the area in which you want to make a CQ call, into "UR."
 - See p. 36 for station call sign programming.
- ④ Set the repeater's call sign as follows;
 - ① Enter "R1" in call sign set mode.

⟨MENU screen⟩ ⇄ ⟨CALL SIGN⟩ ⇄ ⟨R1⟩
(Push [MENU/PTT]) (Rotate [DIAL]†, then push [←](5)‡.)

- Pushing and holding [CS](9) for 1 sec. is also available to enter call sign set mode.
- ② Rotate [DIAL]† to select the nearest repeater's call sign.
 - If the nearest repeater is a gateway repeater, select the repeater's call sign with "G" setting at the 8th digit.
 - ③ Push [←](5) to set the call sign for "R1."
 - Return to CALL SIGN screen.
 - ④ Rotate [DIAL]† to select "R2" then push [←](5)†.
 - ⑤ Rotate [DIAL]† to select the gateway repeater's (in the same zone) call sign.
 - The call sign should have "G" set as at the 8th digit.
 - When gateway repeater call sign is set in "R1," select "NOT USE*" for "R2" setting.

- ⑥ Push [←](5) to set the call sign for "R2."
 - Return to CALL SIGN screen.

```
CALL SIGN
▶UR: CQCQCQ
R1: RPT1AA
R2: NOT USE*
MY: MYCALL
  /IC92
```

- ⑦ Push [MENU/PTT] to return to frequency indication.
- ⑤ Push [PTT] to transmit; release to receive.

†[DIAL] ⇄ [A](2)/[M](8) ‡[←](5) ⇄ [▶](6)

• Setting example 2

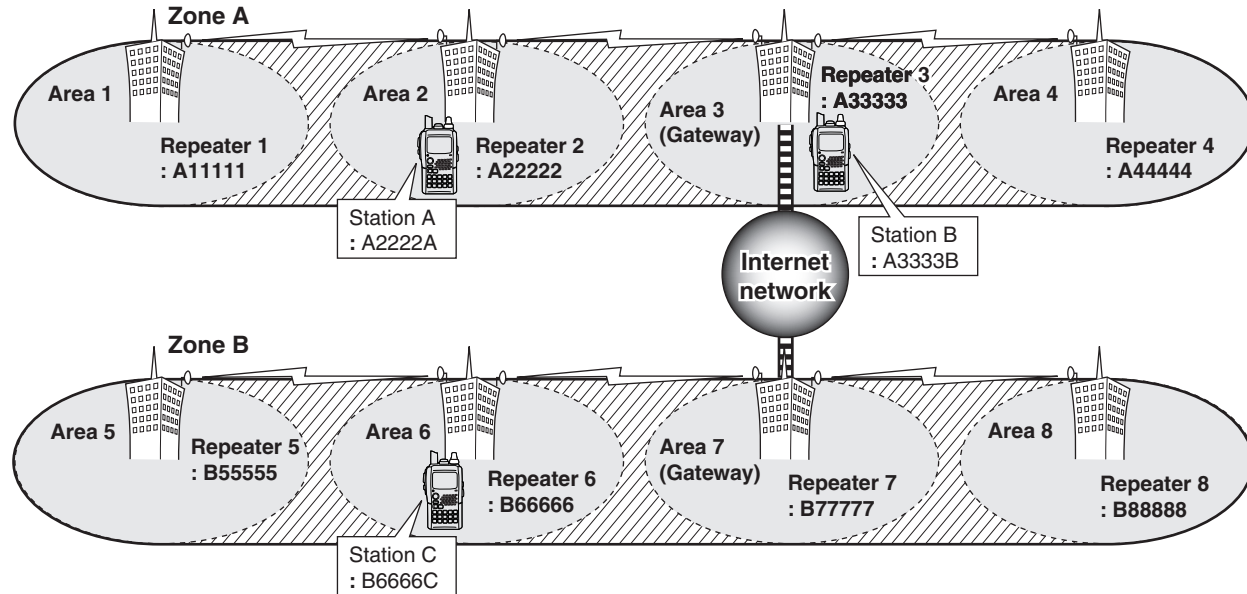

7

The setting when Station A is calling Station C

UR : B6666C
 R1 : A22222
 R2 : A33333 G
 MY : A2222A

The setting when Station A is making a CQ call in Area 8

UR : /B88888
 R1 : A22222
 R2 : A33333 G
 MY : A2222A

The setting when Station B is calling Station C

UR : B6666C
 R1 : A33333 G
 R2 : NOT USE**
 MY : A3333B

*It can be used even if it doesn't input "R2".

Received call sign

When a call is received in DV mode, the calling station and the repeater call signs being used can be stored into the received call record. The stored call signs are viewable in the following manner.

Up to 20 calls can be recorded.

Desired call record indication

① Enter RX call sign set mode.

⟨MENU screen⟩ ⇄ ⟨RX CALL SIGN⟩
 (Push [MENU/↵] (O)) (Rotate [DIAL]†, then push [←](5)‡.)

- Pushing and holding [CD](.) for 1 sec. is also available to enter RX call sign set mode.
- RX CALL SIGN screen is displayed.

② Rotate [DIAL]† to select the desired record channel.

③ To confirm the received call, push [←](5) several times to select the desired call sign from CALLER, CALLED, RXRPT1 and RXRPT2.

- CALLER** : The station call sign that made a call.
- CALLED** : The station call sign called by the caller.
- RXRPT1** : The repeater call sign used by the caller station.
- RXRPT2** : The repeater call sign linked from RXRPT1.

④ Push [MENU/↵] (O) to return to frequency indication.

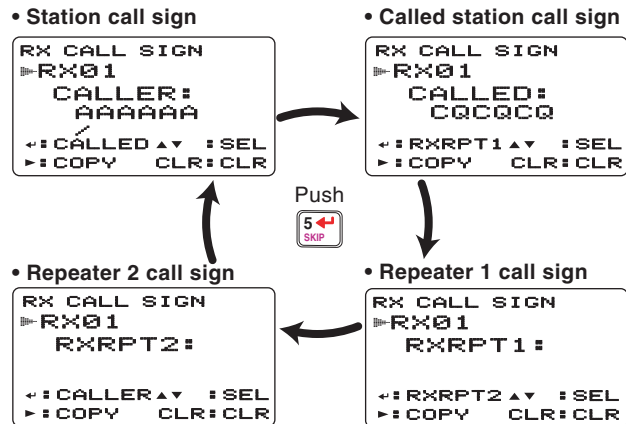

NOTE: When a call is received in DV mode when the power save function is activated, the call sign may not be received correctly.

This is normal, not a malfunction, because the call sign information cannot be detected during power save.

Turn the power save function OFF (p. 129) if you want to receive a call sign correctly even in stand-by operation.

✓ For your information

When receiving a call, the received station call sign is automatically displayed and scrolled in sequence at the bottom line of the function display.

This can be turned OFF in display set mode. (p.113)

[DIAL] ⇄ [A](2)/[V](8) † [←](5) ⇄ [▶](6)

◇ One-touch reply using the call record

The stored call signs in the call record can be used to the call.

- ① After receiving a call, push and hold [RX→CS](CALL) for 1 sec.
Or, while pushing and holding [RX→CS](CALL), rotate [DIAL] to select the desired call sign record.

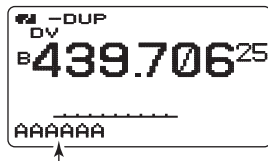

The received call sign is displayed while pushing and holding [CALL/RX→CS] when [DIAL] is rotated while [CALL/RX→CS] is pushed.

- Set your own call sign (MY) in advance. (p. 34)
 - The call sign stored in “CALLER” is stored as “UR,” “RXRPT1” is stored as “R2” and “RXRPT2” is stored as “R1.”
 - Error beeps sound when a call sign is received incorrectly, and no call sign is set in this case.
- ② Push [PTT] to transmit; release to receive.

Important!

Setting call signs with the “One-touch reply using the call record” operation as at left are for temporary operation only. Therefore, the set call signs will be overwritten when another call record is used to set call signs.

- Never saved into a call sign memory.

If you want to save the set call signs, see “Copying the call record contents into call sign memory” (p. 50) for details.

✓ For your information

When a call specifying your call sign is received, the call signs of the calling station and the repeater it is using can be automatically used for operation.

- When “RX call sign auto write” (p. 101) is set to “AUTO,” the station call sign in “CALLER” is set to “UR” automatically.
- When “Repeater call sign auto write” (p. 101) is set to “AUTO,” the stored station call sign in “RXRPT1” is stored as “R2” and “RXRPT2” is stored as “R1” automatically.

■ Copying the call sign

◇ Copying the call sign memory contents

This function is convenient when or modifying a part of the current call sign.

NOTE: Make sure that the “EDIT RECORD” item in DV set mode is set to “AUTO” or “SELECT” in advance. (p. 106)

⟨MENU screen⟩ ⇄ ⟨CALL SIGN⟩
 (Push [MENU/↵]) (Rotate [DIAL]†, then push [←](5)†.)

- ① During DV mode operation, enter call sign set mode.
 - Pushing and holding [CS](9) for 1 sec. is also available to enter call sign set mode.
 - CALL SIGN screen is displayed.
- ② Rotate [DIAL]† to select “UR,” “R1” or “R2” as desired, then push [←](5)†.
- ③ Rotate [DIAL]† to select the desired call sign channel to be copied.
 - U01–U60 and R01–R60 are available.

• When “AUTO” is set to “EDIT RECORD” item

- ④ Push [▶](6) to select the call sign programming mode.
 - A blank channel is selected automatically.
 - The 1st digit of the selected call sign blinks.

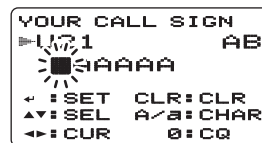

- ⑤ Edit or modify the selected call sign as described in “Station call sign programming” (p. 36) or “Repeater call sign programming” (p. 41).
- ⑥ Push [←](5) to store the edited/modified call sign into the selected blank channel.

NOTE: The message “FULL” is displayed when no blank channel is available in station or repeater call sign memory. In this case, select the desired call sign channel number as described in step ③ is set to “EDIT RECORD” item” at right.

• When “SELECT” is set to “EDIT RECORD” item

- ④ Push [▶](6) to select the call sign programming mode.
 - The 1st digit of the selected call sign blinks.
- ⑤ Edit or modify the selected call sign as described in “Station call sign programming” (p. 36) or “Repeater call sign programming” (p. 41).
- ⑥ Push [◀](5).
 - Call sign channel number blinks.



- ⑦ Rotate [DIAL][†] to select the desired call sign channel to store.
- ⑧ Push [◀](5) to store the edited/modified call sign into the selected channel.

[†][DIAL] ↔ [▲](2)/[▼](8) [‡][◀](5) ↔ [▶](6)

◇ Copying the call record contents into call sign memory

This is a way to copy the call record contents (“CALLER,” “RXRPT1” and “RXRPT2”) into call sign memory (“UR,” “R1” and “R2”) at the same time or individually.

- ① Perform the steps ① to ③ of “◇ Desired call record indication” (p. 46) to select the desired call record or call sign.
- ② Push **[▶](6)** to select copy select mode.
 - COPY SELECT screen is displayed.

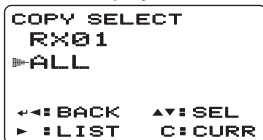

- ③ Rotate **[DIAL]†** to select the desired call sign to be copied from “ALL,” “RXRPT1,” “RXRPT2” and “CALLER.”
 - “ALL” selection won’t appear when either station or repeater call sign memory has no blank channel.

• When “ALL” is selected

- Push **[▶](6)** to copy the selected record’s contents into the appropriate call sign memory.
 - Returns to RX CALL SIGN screen automatically.

• When “CALLER,” “RXRPT1” or “RXRPT2” is selected

- ① Push **[▶](6)** then rotate **[DIAL]†** to select the desired condition of call sign memory channel selection to be copied to from “AUTO” and “LIST SEL.”
 - “AUTO” selection won’t appear when the appropriate call sign memory has no blank channel.
 - Go to step ④ when “AUTO” is selected.

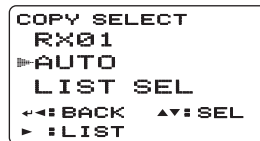

- ② Push **[▶](6)**, then select the desired call sign memory channel to copy to with **[DIAL]†**.
- ③ Push **[▶](6)** to copy the call sign into the selected call sign memory.
 - Returns to RX CALL SIGN screen automatically.
- ④ Push **[MENU/↔](8)** to return to frequency indication.

■ Break-in communication

The break-in function allows you to break into a conversation, where the two original stations are communicating with call sign squelch enabled.

- ① While receiving an another station's communication, push and hold **[RX→CS](CALL)** for 1 sec. to set the communicating station's call sign.
 - When a call sign has not been received correctly, error beeps sound and no call sign is set. Try to set the call sign of a communicating signal again, or set the call sign manually.
- ② Turn the Break-in function ON in the MENU screen operation (p. 106), then exit the MENU screen operation.
 - "BK" appears.

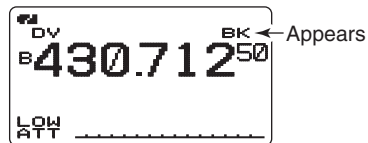

- ③ When both stations are in standby, push **[PTT]** to transmit a break-in call.
 - The programmed call sign station receives the break-in call as well as your call sign.
- ④ Wait for the reply call from the station who receives the break-in call.
- ⑤ After receiving the reply call, communicate normally.
- ⑥ To cancel the break-in function, turn the Break-in function OFF in the MENU screen operation (p. 106).

NOTE: The break-in function is turned OFF automatically when turning transceiver's power OFF

• How to use the break-in?

While operating with the call sign squelch (p. 124), the squelch never opens (no audio sounds) even if a call is received, unless your own call sign ("MY") is specified.

However, when the call including the "BK ON" signal (break-in call) is received, the squelch will open and audio sounds even if the call is specified for another station.

• Station C calling to Station A with "BK OFF"

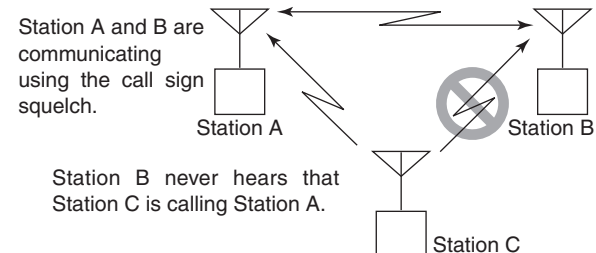

• Station C calling to Station A with "BK ON"

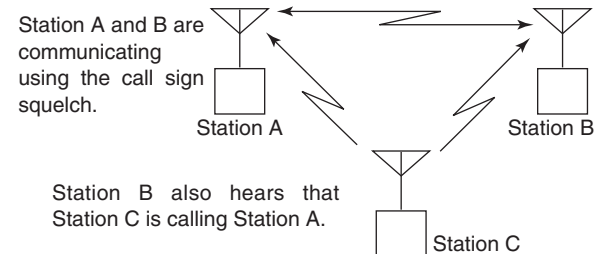

Message operation

◇ TX message programming

TX messages are available for up to 5 channels and each channel can be programmed with a message of up to 20 characters. Available characters are **0** to **9**, **A** to **Z** (capital letters), **a** to **z** (lower case letters), some symbols and space.

① Enter "TX MESSAGE" in message/position set mode.

◀MENU screen▶ ⇄ ◀MESSAGE/POSITION▶ ⇄ ◀TX MESSAGE▶
 (Push [MENU/↻](O)) (Rotate [DIAL]†, then push [←](5)†.)

- TX MESSAGE screen is displayed.
- ② Rotate [DIAL]† to select the desired transmit message channel.
 - Ch01 to Ch05 and OFF are available.
 - Previously message is displayed if programmed.
- ③ Push [▶](6) to select the message edit condition.
 - The 1st digit of the message blinks.



- ④ Rotate [DIAL]† to select the desired character or symbol.
 - Push [A/a](3) to change the character group from "AB" (alphabetical characters; capital letters), "ab" (alphabetical characters; lower case letters), "12" (numbers) and "!" (symbols) in sequence.
 - If an un-necessary character is entered, push [▶](6) or [←](4) to select the character, then push [CLR](1) to erase the selected character, or push and hold [CLR](1) for 1 sec. to erase all characters following the cursor.
- ⑤ Push [▶](6) to select 2nd digit, then rotate [DIAL]† to select the desired character or code.
 - Push [▶](6) to move the cursor right; push [←](4) to move the cursor left.
 - 2nd digit blinks (1st digit stops blinking).
- ⑥ Repeat the steps ④ and ⑤ to enter the desired message.
 - Up to 20-character messages can be set.



- ⑦ Push [←](5) to store the message.
- ⑧ Push [MENU/↻](O) to return to frequency indication.

◇ Message Transmission

Toggle the message transmission function ON (Ch01–05) and OFF. When a message channel is selected, the transceiver transmits a text message (pre-programmed). (default: OFF)

- ① Set the operating frequency, call signs and other settings, such as repeater operation, as desired in B band.
- ② Perform the steps ① to ③ in “◇ TX message programming” as at left.
- ③ Rotate **[DIAL]**[†] to select the desired message channel.
 - “Ch01” to “Ch05” available.
 - See left-hand pages for message programming.
- ④ Push **[◀](5)** to set the message for transmission.
- ⑤ Push **[PTT]** to transmit the selected message.
 - The message is transmitted each time [PTT] is pushed.
 - The message is transmitted each 30 sec. automatically during continuous transmission.
- ⑥ Release **[PTT]** to return to receive.
- ⑦ When the reply call with a message is received, the call sign and the message scrolls at the bottom of the function display.

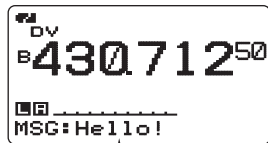

Scrolls the received message.

✓ For your information

The automatic received call sign and/or message indication can be turned OFF in display set mode, if desired.

➔ RX CALL SIGN (p. 113)

➔ RX MESSAGE (p. 113)

NOTE: Only one message can be stored in the IC-92AD. The received message is cleared by turning power OFF, or overwritten when another message is received. A transmitted message that includes lower case characters from the IC-92AD may not be decoded and displayed correctly by the ID-800H, IC-V82/U82, etc.

[†][DIAL] ↔ **[▲](2)/[▼](8)** [‡][◀](5) ↔ **[▶](6)**

◇ RX message indication

The received message can also be checked in message/position set mode.

- ① Select “RX MESSAGE” in message/position set mode.

⟨MENU screen⟩ ⇄ ⟨MESSAGE/POSITION⟩ ⇄ ⟨RX MESSAGE⟩
 (Push [MENU/↵]) (Rotate [DIAL]†, then push [←](5)‡.)

- The received message is displayed in RX MESSAGE screen.

```

RX MESSAGE
=>MESSAGE:

Hello!

<-=> BACK >=> CALLER
    
```

- ② Rotate [DIAL] or push [♥](8) to display the station call sign.

```

RX MESSAGE
=>CALLER:

BBBBBB
  /
<-=> BACK ▲ MSG
    
```

- ③ Push [←](5) or [◀](4) to return to MESSAGE/POSITION screen.
- ④ Push [MENU/↵] to return to frequency indication.

■ Automatic reply function

The automatic reply function replies to calls by a station that specified your call sign.

Two methods of replying are available— one is making a reply call with your own call sign, and other one is making a reply call with reply voice audio that has been recorded in DV voice memory.

◇ Automatic reply function setting

- ① Enter “AUTO REPLY” in DV set mode. (p. 100)

⟨MENU screen⟩ ⇄ ⟨DV SET MODE⟩ ⇄ ⟨AUTO REPLY⟩
 (Push [MENU/↵]) (Rotate [DIAL]†, then push [←](5)‡.)

- AUTO REPLY screen is displayed.
- ② Rotate [DIAL]† to select the desired reply condition.
 - OFF** : Deactivate the automatic reply function. (default)
 - ON** : Reply to the call with your own call sign.
 - VOICE** : Reply to the my call sign, etc with the recorded voice memory automatically.

```

AUTO REPLY
=>OFF
ON
VOICE
    
```

- ③ Push [←](5).
 - Returns to DV SET MODE screen automatically.
- ④ Push [MENU/↵] to return to frequency indication.

◇ Voice memory recording for automatic reply

IMPORTANT!

Deactivate the dualwatch function and set minimum [VOL] level when recording the DV voice memo. Otherwise received audio or unwanted noise from A band is also recorded into the voice memory.

- ① Select DV mode in B band, and deactivate the priority watch (p. 91) and weather alert function (p. 128) if activated.
- ② Enter "REPLY VOICE" in DV voice memo set mode.

◀MENU screen▶ ↔ ◀DV VOICE MEMO▶ ↔ ◀REPLY VOICE▶
 (Push [MENU/PTT]) (Rotate [DIAL]†, then push [←](5)‡.)

- REPLY VOICE screen is displayed.

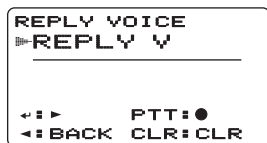

- ③ While pushing and holding [PTT], speak into the microphone.
 - Up to 10 seconds of message is recordable.
 - The recording stops after 10 second or when [PTT] is released.
- ④ Push [←](4) to return to DV VOICE MEMO screen.
- ⑤ Push [MENU/PTT] to return to frequency indication.

◇ Play-back or erase the voice memory

- ① Push [MENU/PTT] to select menu mode indication.
- ② Rotate [DIAL]† to select "DV VOICE MEMO," then push [←](5)‡.
- ③ Rotate [DIAL]† to select "REPLY VOICE," then push [←](5)‡.
 - REPLY VOICE screen is displayed.
 - "REPLY V*" is displayed when voice memory has been recorded.
- ④ To play-back the recorded voice memory, push [←](5).
 - Push [←](5) again to pause, push [▶](6) to cancel the play-back.
- ⑤ To erase the recorded voice memory, push and hold [CLR](1) for 1 sec.
 - "*" disappears when voice memory erases.

†[DIAL] ↔ [▲](2)/[▼](8) ‡[←](5) ↔ [▶](6)

■ EMR (Emergency) communication

The EMR communication mode is available for digital mode operation. In the EMR communication mode, no call sign setting is necessary. When an EMR communication mode signal is received, the audio (voice) will be heard at the specified level even the volume setting level is set to minimum level, or digital call sign/digital code squelch is in use.

- ① Set the desired frequency in 144 or 440 MHz band then push **[MENU/↵]** to select menu mode indication.
- ② Rotate **[DIAL]**† to select “DV SET MODE,” then push **[↵](5)**†.
- ③ Rotate **[DIAL]**† to select “EMR,” then push **[↵](5)**†.
- ④ Rotate **[DIAL]**† to select the desired EMR condition.

OFF : EMR communication set OFF. (default)

ON : EMR communication set ON.

- “EMR” appears when selecting “ON”.

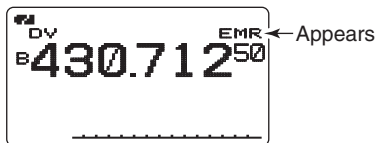

- ⑤ Push **[↵](5)**.
 - Returns to DV SET MODE screen automatically.
- ⑥ Push **[MENU/↵]** to return to frequency indication.

NOTE: The EMR communication function is turned OFF automatically when turning transceiver's power OFF

■ Low-speed data communication

In addition to the digital voice communication, low-speed data communication is available.

The optional OPC-1799 DATA COMMUNICATION CABLE and serial data communication software (purchase locally) are required in addition.

The optional RS-92 REMOTE CONTROL SOFTWARE (OPC-1799 supplied) also includes a low-speed data communication capability.

/// **NOTE:** Turn OFF the GPS mode (p. 58) in advance to operate the low-speed data communication.

◇ Connection

Connect the transceiver to your PC using with the optional OPC-1799 as illustrated below.

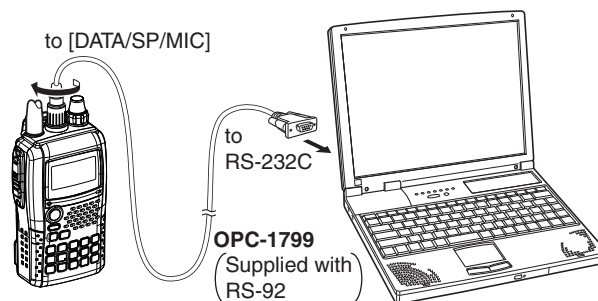

◇ Low-speed data communication application setting

Configure the low-speed data communication application as follows.

- Port : The same COM port number as IC-92AD's
- Baud rate : 38.4 kbps (fixed value)
- Data : 8 bit
- Parity : None
- Stop : 1 bit
- Flow control : Xon/Xoff

◇ Low-speed data communication operation

NOTE: Confirm that in AUTO, the computer controls when [PTT] is activated to send data and the user doesn't have to operate the radio.

- ① Set your own, station call signs, etc. as described in "Digital voice mode operation" (p. 38) and "Digital repeater operation" (p. 41).
- ② Refer to the instructions of the low-speed data communication application.
- ③ To transmit data
 - At the same time as your voice audio, push and hold [PTT] to transmit while sending data from the PC. Release [PTT] to receive.
 - Under computer control, see Transmission condition setting at right.

◇ Transmission condition setting

- ① Enter "DV DATA TX" in DV set mode. (p. 100)

◀MENU screen▶ ↔ ◀DV SET MODE▶ ↔ ◀DV DATA TX▶
(Push [MENU/PTT-O]) (Rotate [DIAL]†, then push [←](5)‡.)

- ② Rotate [DIAL]† to select "PTT" or "AUTO."
 - PTT** : The input data from [DATA/SP/MIC] are transmitted when pushing [PTT]. (default)
 - AUTO** : The input data from [DATA/SP/MIC] are transmitted automatically when the data are input.
- ③ Push [←](5) (or [↩](4)) to return to DV set mode, and push [MENU/PTT-O] to return to frequency indication.

✓ For your information

While operating low-speed data communication via the internet network from one zone to another zone, some packets may be lost due to network error (poor data throughput performance). In such a case, the IC-92AD displays an "L" in the upper right corner on the display to indicate Packet Loss has occurred.

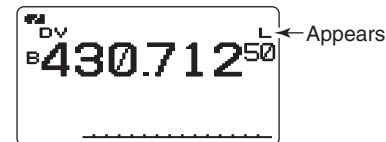

†[DIAL] ↔ [▲](2)/[▼](8) ‡[←](5) ↔ [▶](6)

Other functions for DV mode operation

◇ DV voice memory

The IC-92AD has a DV voice memory that records a total 30 second (approx.) of received audio.

The DV voice memory is divided into 2 tracks, 15 seconds each in a track, as the default setting.

◆ Recording received audio

- ① Select DV mode in B band, and deactivate the priority watch (p. 91) and weather alert function (p. 128) if activated.
- ② While receiving a DV signal, push [REC].



- ③ Rotate [DIAL] to select the desired track.
 - “*” is displayed beside the track number when the selected track has been recorded.
- ④ Push [REC] to start recording.
 - Track counter (bar meter) is displayed during record.
 - The recording is paused automatically when the DV signal is interrupted or when the DV audio signal cannot be received correctly. Re-starts the recording when the DV audio signal is received correctly.
- ⑤ Push [REC] again to stop recording.
 - The recording stops automatically when the track becomes full.

◆ Track size setting

The track size can be changed with the following instruction.

- ① Enter “TRACK SIZE” in DV voice memo set mode.

◀MENU screen> ⇄ <DV VOICE MEMO> ⇄ <TRACK SIZE>
 (Push [MENU/⏏]) (Rotate [DIAL]†, then push [←](5)†.)

- TRACK SIZE screen is displayed

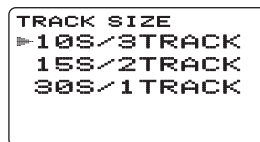

- ② Rotate [DIAL]† to select the desired track size.
 - 10S/3TRACK** : Makes 3 tracks and 10 seconds audio can be recorded in each track.
 - 15S/2TRACK** : Makes 2 tracks and 15 seconds audio can be recorded in each track.
 - 30S/1TRACK** : Makes 1 track only and 30 seconds audio can be recorded in a track.
- ③ Push [←](5) (or [↩](4)) to return to DV VOICE MEMO screen.
- ④ Push [MENU/⏏] to return to frequency indication.

◆ Playing-back and erasing the recorded audio

- ① Select DV mode in B band, and deactivate the priority watch (p. 91) and weather alert function (p. 128) if activated.
- ② Enter "TRACK" in DV voice memo set mode.

⟨MENU screen⟩ ⇨ ⟨DV VOICE MEMO⟩ ⇨ ⟨TRACK⟩
(Push [MENU/⏏]) (Rotate [DIAL][†], then push [←](5)[‡].)

- TRACK screen is displayed

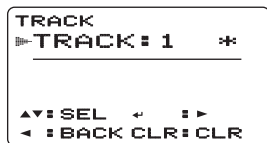

- ③ Rotate [DIAL][†] to select the desired audio track to be played back or erased.
 - "*" is displayed beside the track number when the selected track has been recorded.
- ④ Push [←](5) to play-back the recorded audio.
 - Push [←](5) again to pause, push [▶](6) to stop play-back.
- ⑤ Push and hold [CLR](1) for 1 sec. to erase the recorded audio.
- ⑥ Push [←](4) to return to DV VOICE MEMO screen.
- ⑦ Push [MENU/⏏] to return to frequency indication.

◇ DV auto detect

The "DV" mode indicator blinks when a non-DV signal is received during DV mode operation.

When a signal other than DV mode is received, the IC-92AD DV automatic detection switches to monitor in FM mode

- ① Enter "AUTO DETECT" in DV set mode. (p. 106)

⟨MENU screen⟩ ⇨ ⟨DV SET MODE⟩ ⇨ ⟨AUTO DETECT⟩
(Push [MENU/⏏]) (Rotate [DIAL][†], then push [←](5)[‡].)

- ② Rotate [DIAL][†] to turn the DV automatic detect function ON and OFF.
 - OFF** : "DV" mode indicator blinks, however the transceiver receives in DV mode even if non-DV mode signals are received.
 - ON** : "DV" mode indicator blinks and the transceiver monitors the signal when receiving except DV mode signal in FM mode.
- ③ Push [←](5) (or [←](4)) to return to DV SET MODE screen
- ④ Push [MENU/⏏] to return to frequency indication.

/// **NOTE:** The received FM audio may be distorted when receiving an FM signal with DV automatic detect function.

†[DIAL] ↔ [▲](2)/[▼](8) ‡[←](5) ↔ [▶](6)

■ GPS operation

Displaying (FM/FN-N/WFM/AM/DV mode) or transmitting (DV mode only) GPS data is available when connecting an optional HM-175GPS (GPS speaker microphone) or 3rd party GPS receiver* (RS-232C output/NMEA format). GPS data pass through the **[DATA/SP/MIC]** jack of the IC-92AD.

In addition, the GPS message transmission is also available in GPS mode operation.

*GPS receiver with RS-232C terminal is required.

*Set "GPS TX MODE" to "GPS" or "GPS-A" at ④ operation of right column when connecting a 3rd party GPS receiver.

NOTE: See p. iv about the optional HM-175GPS outputs GPS data for details.

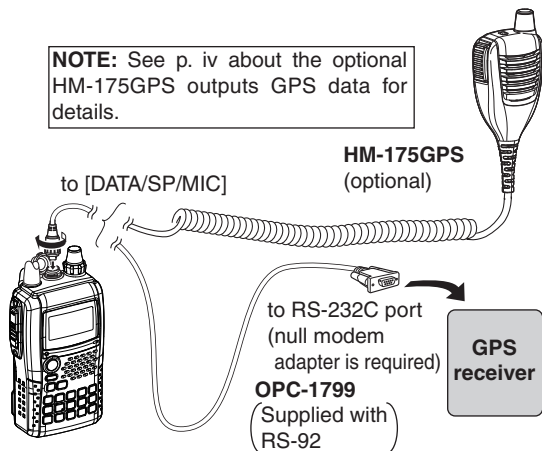

◇ Sentence formatter setting

① Enter "GPS MODE" in DV set mode. (p. 102)

◀MENU screen> ⇄ <DV SET MODE> ⇄ <GPS TX MODE>
(Push **[MENU/TT-O]**) (Rotate **[DIAL]**†, then push **[←](5)**†.)

• GPS TX MODE screen is displayed.

```
GPS TX MODE
OFF
▷ GPS
GPS-A
▶ : SENTENCE
```

② Rotate **[DIAL]**† to select "GPS."

③ Push **[←](5)**† to select GPS SENTENCE screen.

④ Rotate **[DIAL]**† to select the desired GPS sentence, then push **[←](5)**†.

• A total 6 sentences, RMC, GGA, GLL, GSA, VTG and GSV are available.

⑤ Rotate **[DIAL]**† to turn the sentence usage ON and OFF.

⑥ Push **[←](5)** (or **[←](4)**) to return to GPS SENTENCE screen.

⑦ Repeat the steps ④ to ⑥ to set another GPS sentence usage.

• Up to 4 GPS sentences are usable at the same time.

⑧ Push **[MENU/TT-O]** to return to frequency indication.

NOTE: Set the GSV sentence to OFF when sending the GPS message to conventional digital transceivers (IC-2820, IC-D800H, IC-91AD, IC-V82, IC-U82). The GSV sentence is incompatible with them. Those transceivers will not display GPS messages properly if sent as a GSV sentence from the IC-92AD.

◇ GPS message programming

- ① Enter "GPS" in message/position set mode.

⟨MENU screen⟩ ↔ ⟨MESSAGE/POSITION⟩ ↔ ⟨GPS⟩
(Push [MENU/↻] (5)†) (Rotate [DIAL]†, then push [←] (5)‡.)

- GPS MESSAGE screen is displayed.



- ② Push [▶] (6) to select the message edit condition.
- The 1st digit of the message blinks.

- ③ Rotate [DIAL]† to select the desired character or symbol.
- Push [A/a] (3) to change the character group from "AB" (alphabetical characters; capital letters), "ab" (alphabetical characters; lower case letters), "12" (numbers) and "!" (symbols) in sequence.
- ④ Push [▶] (6) to select 2nd digit, then rotate [DIAL]† to select the desired character or code.
- Push [▶] (6) to move the cursor right; push [◀] (4) to move the cursor left.
 - 2nd digit blinks (1st digit stops blinking).
- ⑤ Repeat the steps ④ and ⑤ to enter the desired message.
- Up to 20-character messages can be set.



- ⑥ Push [←] (5) to store the message.
- ⑦ Push [MENU/↻] (5) to return to frequency indication.

†[DIAL] ↔ [A] (2)/[V] (8) ‡[←] (5) ↔ [▶] (6)

8 GPS/GPS-A OPERATION

◇ GPS message automatic transmission

① Enter “GPS AUTO TX” in DV set mode. (p. 106)

⟨MENU screen⟩ ⇄ ⟨DV SET MODE⟩ ⇄ ⟨GPS AUTO TX⟩
(Push [MENU/↵]) (Rotate [DIAL]†, then push [←](5)†.)

• GPS AUTO TX screen is displayed.

```
GPS AUTO TX
▷OFF
5SEC
10SEC
30SEC
1MIN
```

② Rotate [DIAL]† to select the desired position data transmitting interval from 5 sec., 10 sec., 30 sec., 1 min., 3 min., 5 min., 10 min., 30 min. and OFF.

• The GPS message is also transmitted if programmed.

③ Push [←](5) (or [↵](4)) to return to DV SET MODE screen.

④ Push [MENU/↵] to return to frequency indication.

/// **NOTE:** Your own call sign (“MY”) must be set to activate the GPS automatic transmission.

[NOTICE]

“5SEC” cannot be selected when 4 GPS sentences are selected.

[NOTICE]

Only use GPS message automatic transmission in simplex mode. Automatic GPS message transmission through a repeater may interfere with other communications.

◇ Received GPS message indication

⟨MENU screen⟩ ⇄ ⟨MESSAGE/POSITION⟩ ⇄ ⟨RX GPS⟩
(Push [MENU/↵]) (Rotate [DIAL]†, then push [←](5)†.)

① Enter “RX GPS” in message/position set mode.

```
RX GPS MESSAGE
▷DATA:

Call from
Osaka!
◀BACK
```

• RX GPS MESSAGE screen is displayed.

② Push [←](5) (or [↵](4)) to return to MESSAGE/POSITION screen.

③ Push [MENU/↵] to return to frequency indication.

◇ Position indication

① Enter "POSITION" in message/position set mode.

⟨MENU screen⟩ ⇨ ⟨MESSAGE/POSITION⟩ ⇨ ⟨POSITION⟩
(Push [MENU/⇨] (Rotate [DIAL][†], then push [⇨](5)[‡].)

- GPS POSITION screen is displayed.

```

GPS POSITION
▶MY POSITION

 34°56.78' N
123°45.67' E
⇨BACK ▼RX POS
  
```

- ② Rotate [DIAL][†] to select the received position data indication.
- MY POSITION and ELEVATION or RX POSITION and DISTANCE display at the same time when selecting SMALL on the FONT SIZE in the set mode.
- ③ Push [⇨](5) (or [⇩](4)) to return to MESSAGE/POSITION screen.
- ④ Push [MENU/⇨] to return to frequency indication.

NOTE: The ELEVATION may be overwritten by received signal strength.

[Indication items]

- **MY POSITION** : Displaying own latitude and longitude.
- **RX POSITION** : Displaying other station latitude and longitude.
- **ELEVATION** : Displaying own elevation and the time.
- **DISTANCE** : Displaying distance from other station.

◇ Saving own/received position data

- ① Operate ① – ④ of "Position indication" (See left column), and select the desired position data.
- ② Push and hold [S.MR](MR) for 1 sec. to save the selected position data to GPS memory (CH00).
- The M-CH number advances automatically in case the next M-CH is already contains information.
 - 100 GPS M-CH are available.
 - Push [MR] to display stored position data.

[†][DIAL] ⇨ [▲](2)/[▼](8) [‡][⇨](5) ⇨ [⇩](6)

8 GPS/GPS-A OPERATION

◇ Displaying own/received position data with compass

Displaying own direction, received station's direction and set position and direction in the GPS memory.

① Enter "COMPAS" in message/position set mode.

⟨MENU screen⟩ ⇄ ⟨MESSAGE/POSITION⟩ ⇄ ⟨COMPAS⟩
(Push [MENU/↶]) (Rotate [DIAL]†, then push [↶](5)†.)

- COMPAS screen is displayed.

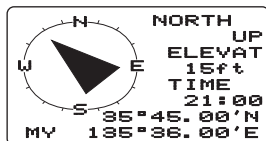

② Rotate [DIAL]† to select the received position data indication.

- MY, RX or SET is available.

[Indication items]

- **MY** : Displays own latitude, longitude, elevation, the time and direction.
- **RX** : Displays other station latitude, longitude, distance from own and direction.
- **SET** : Displays latitude, longitude, distance from own position and direction of alarm setting for GPS memory.

③ Push and hold [S.MR](MR) for 1 sec. to save the selected position data to GPS memory (CH00).

- The M-CH number advances automatically in case the next M-CH is already contains information.
- 100 GPS M-CH are available.
- Push [MR] to display stored position data.

④ Push [↶](5) (or [↶](4)) to return to MESSAGE/POSITION screen.

⑤ Push [MENU/↶] to return to frequency indication.

◇ GPS data addition

① Enter “GPS MEMORY” in message/position set mode.

`<MENU screen> ⇨ <MESSAGE/POSITION> ⇨ <GPS MEMORY>`
 (Push **[MENU/↻]**) (Rotate **[DIAL]**†, then push **[←](5)**.)

- GPS MEMORY screen is displayed.

```
GPS MEMORY
RX
ALL
A:
← : SET   ▲▼ : SEL
▲ : BACK  ▶   : EDIT
                C : ALM
```

② Rotate **[DIAL]**† to select the desired memory bank or ALL, then push **[▶](6)**.

③ Rotate **[DIAL]**† to select <ADDITION>, then push **[←](5)**.

```
BANK A
◀<ADDITION>

← : SET
▲ : BACK
```

④ Rotate **[DIAL]**† to select desired items (NAME, TIME, LATITUDE, LONGITUDE, BANK or BANK NAME), then push **[▶](6)** to edit the selected item.

```
<ADDITION>
▶NAME:

← : SET   ▲▼ : SEL
▲ : BACK  ▶   : EDIT
```

⑤ Rotate **[DIAL]**† to select the desired character or symbol.

⑥ Push **[▶](6)** to select 2nd digit, then rotate **[DIAL]**† to select the desired character or code.

- Push **[▶](6)** to move the cursor right; push **[◀](4)** to move the cursor left.
- 2nd digit blinks (1st digit stops blinking).

```
<ADDITION>
▶NAME:      AB
  ☼
← : SET   ▲▼ : SEL
▲ : BACK  ▶   : EDIT
```

⑦ Repeat the steps ④ and ⑤ to enter the desired message.

- Up to 8-character messages can be set.

⑧ Push **[←](5)** to add the GPS data.

⑨ Push **[MENU/↻]** to return to frequency indication.

†**[DIAL]** ↔ **[▲](2)**/**[▼](8)** ‡**[←](5)** ↔ **[▶](6)**

8 GPS/GPS-A OPERATION

◇ GPS alarm setting

GPS alarm sounds when your own position is close the specified position. This function can be set to use information from the received channel, a specified GPS memory channel, all GPS memory channels or a memory bank.

① Enter "GPS MEMORY" in message/position set mode.

⟨MENU screen⟩ ⇨ ⟨MESSAGE/POSITION⟩ ⇨ ⟨GPS MEMORY⟩
(Push [MENU/⇄]) (Rotate [DIAL]†, then push [←](5)†.)

- GPS MEMORY screen is displayed.

```
GPS MEMORY
▷RX
ALL
A:
← :SET  ▲ :SEL
▶ :BACK ▶ :EDIT
C :ALM
```

② Rotate [DIAL]† to select the desired memory bank or memory channel.

- "RX", "ALL", one of the memory bank or memory channel can be selected.
- Skip ③ and operate ④ when alarm RX, ALL, BANK A–Z set.

③ Push [▶](6), then rotate [DIAL]† to select the desired memory channel.

```
BANK A
<ADDITION>
▷01: BAY AREA
02: KOBE AIR
← :SET  ▲ :SEL
▶ :BACK ▶ :EDIT
C :ALM
```

④ Push [C](CALL) to switch alarm function ON or OFF.

```
BANK A
<ADDITION>
▷01: BAY ARE ④
02: KOBE AIR
← :SET  ▲ :SEL
▶ :BACK ▶ :EDIT
C :ALM
```

← Alarm mark appears at 8-digits of memory name.

⑤ Push [◀](4) to return to GPS MEMORY screen.

⑥ Push [MENU/⇄] to return to frequency indication.

✓ For your information!

- When "ALL" or memory channel is selected above step ④, alarm functions depending on "ALM AREA1" setting in the GPS set mode (p. 69).
- When "RX" or memory bank is selected above step ④, alarm functions depending on "ALM AREA2" setting in the GPS set mode (p. 69).

◇ GPS memory clearing

① Enter “GPS MEMORY” in message/position set mode.

⟨MENU screen⟩ ⇨ ⟨MESSAGE/POSITION⟩ ⇨ ⟨GPS MEMORY⟩
(Push [MENU/⇄] (1)) (Rotate [DIAL]†, then push [←] (5)‡.)

- GPS MEMORY screen is displayed.

```
GPS MEMORY
=>RX
ALL
A:
← :SET   ▲▼ :SEL
▲ :BACK ▶ :EDIT
      C :ALM
```

② Rotate [DIAL]† to select “ALL” or desired memory bank or memory channel.

- Skip ③ and operate ④ when ALL or each all channels of bank A-Z delete.

③ Push [▶] (6), then rotate [DIAL]† to select the desired GPS memory channel.

```
BANK A
<ADDITION>
=>01: BAY AREA
02: KOBE AIR
← :SET   ▲▼ :SEL
▲ :BACK ▶ :EDIT
      C :ALM
```

④ Push and hold [CLR] (1) for 1 sec. to clear.

- 1 beep sounds, then the memory channel is cleared.
- Remaining channels scroll up.

⑤ Push [←] (4) to return to GPS MEMORY screen.

⑥ Push [MENU/⇄] to return to frequency indication.

†[DIAL] ⇨ [▲] (2) / [▼] (8) ‡[←] (5) ⇨ [▶] (6)

■ GPS set mode items

◇ Entering GPS set mode

① Enter “GPS SET MODE” in message/position set mode.

⟨MENU screen⟩ ⇨ ⟨MESSAGE/POSITION⟩ ⇨ ⟨GPS SET MODE⟩
 (Push [MENU/↵]) (Rotate [DIAL]†, then push [↵](5)‡.)

- GPS SET MODE screen is displayed.

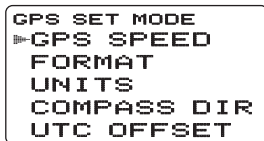

- ② Rotate [DIAL]† to select the desired item, and then push [↵](5)†.
- ③ Rotate [DIAL]† to select the desired value or condition.
- ④ Push [↵](5) (or [↵](4)) to return to GPS SET MODE screen.
- ⑤ Push [MENU/↵] to return to frequency indication.

◇ GPS SPEED

Selects the data transmission speed for packet operation from 4800 bps (default) and 9600 bps.

◇ FORMAT

Selects the displaying position format from ddd°mm.mm´ (default) and ddd°mm´ss´´.

◇ UNITS

Selects display units for distance and elevation from “m” or “ft/ml.”
 (default : U.S.A. version; ft/ml, Other versions; m)

◇ COMPASS DIRECTION

Selects compass indication type from “NORTH REF” (default) and “SOUTH REF.”

◇ UTC offset

Sets time difference from UTC (Universal Time Coordinated) within -12:00 to +12:00 range in 5 min. steps. (default: 0:00)

†[DIAL] ↔ [▲](2)/[▼](8) ‡[↵](5) ↔ [▶](6)

◇ Alarm area 1

Sets GPS alarm active range within 00'05" to 59'59" in 1 sec. (00'01") steps. (default: 00'15")

① Enter "GPS MEMORY" in message/position set mode.

⟨MENU screen⟩ ⇄ ⟨MESSAGE/POSITION⟩ ⇄ ⟨GPS SET MODE⟩
(Push [MENU/⓪]) (Rotate [DIAL]†, then push [←](5)†.)

② The alarm area 1 function is available when the "GPS ALARM" function of ALL or BANK A–Z is turned ON.

- **Example:** Your position : 35°N/135°E
ALM AREA1 setting : 00'15" (default)

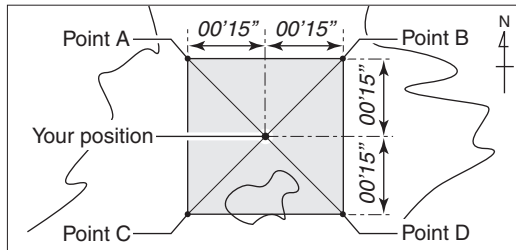

- Position of point A : 35°00'15"N/134°59'45"E
- Position of point B : 35°00'15"N/135°00'15"E
- Position of point C : 34°59'45"N/134°59'45"E
- Position of point D : 34°59'45"N/135°00'15"E

When the target position enters the area as above, the GPS alarm will sound.

◇ Alarm area 2

Selects GPS alarm active range from "LIMITED," "EXTENDED" and "BOTH" when "CH" or "RX" is selected at GPS alarm setting.

- **LIMITED** : GPS alarm*¹ will sound when a target position enters 500 m* (547 Y)* range.
- **EXTENDED** : GPS alarm*¹ will sound when a target position enters 1 km* (1094 Y)* range.
- **BOTH** : GPS alarm*² will sound when a target position enters both 500 m* (547 Y)* and 1 km* (1094 Y)* range. (default)

*Approximate

*¹Three beep sounds.

*²One beep sounds when coming into 500 m (547 Y) and three beep sounds when coming into 1 km (1094 Y).

• **Example:**

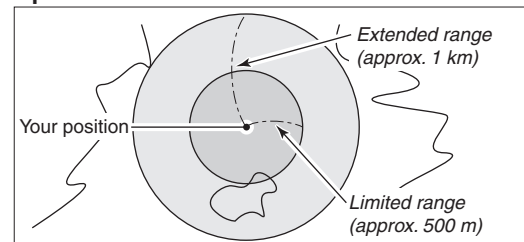

When the target position is coming into either/each area as above, the GPS alarm will sound.

■ GPS-A operation

◇ GPS-A function

Set the following for activate the GPS-A function.

- ① Select the DV mode operation (p. 38)
- ② Select the DV data transmission to AUTO. (p. 100)
- ③ Select the GPS transmission selection to GPS-A. (p. 102)
- ④ Set the GPS auto transmission interval. (p. 106)
- ⑤ Set the GPS-A set items. (p. 103)

◇ GPS-A code details

While in GPS-A operation, following codes are transmitted to your connecting PC. GPS-A code is based on APRS® code. (APRS® : Automatic Position Reporting System)

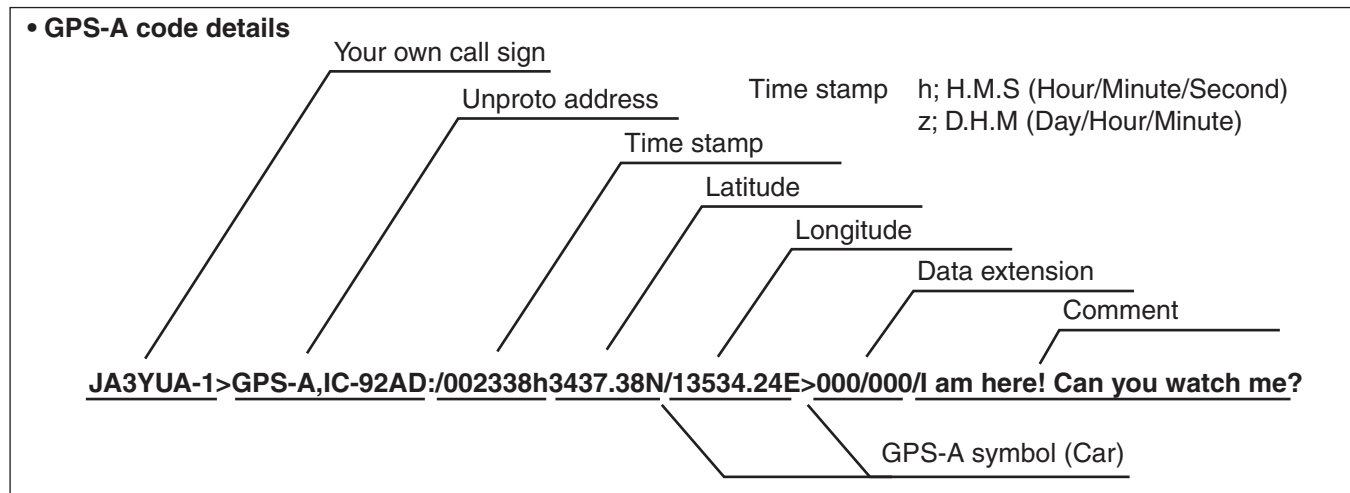

■ General description

The IC-92AD has 850 memory channels in the A band, 450 memory channels in the B band, and 2 call channels in each band. Memory channels in each band include 50 scan edge memory channels (25 pairs) for storage of often-used frequencies, respectively.

And a total of 26 memory banks, A to Z, are available in each band for storing groups of frequencies, etc. Up to 100 channels can be assigned into a bank.

◇ Memory channel contents

The following information can be programmed into memory channels:

- Operating frequency (p. 18)
- Operating mode (p. 21)
- Duplex direction (+DUP or -DUP) with an offset frequency (p. 31)
- Subaudible tone encoder (p. 121), tone squelch or DTCS squelch ON/OFF (p. 124)
- Subaudible tone frequency (p. 121), tone squelch frequency or DTCS code with polarity (pgs. 121, 125)
- Scan skip information (p. 87)
- Memory bank (p. 75)
- Memory name (p. 77)
- Tuning step (p. 18)
- Call sign squelch or Digital code squelch* (p. 124)
- Station call sign* (p. 36)
- RPT1/RPT2 call sign* (p. 41)

*Available for B band operation only.

CAUTION!

Memory data can be erased by static electricity, electric transients, etc.

In addition, they can be erased by malfunction and during repairs.

Therefore, we recommend that memory data be written down or be saved to a PC using the optional RS-92 REMOTE CONTROL SOFTWARE.

■ Selecting a memory channel

◇ Using [DIAL]— Programmed channels

- ① Push [MR] to select memory mode.
- ② Rotate [DIAL] to select the desired memory channel.
 - Only programmed channels are displayed.

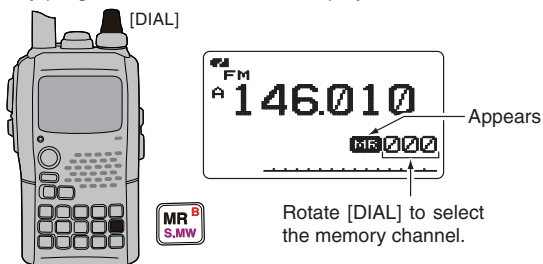

◇ Using [DIAL]— All channels

- ① Push [MR] to select memory mode.
- ② Push and hold [S.MW](MR) for 1 sec. to enter select memory write mode.
 - 1 short and 1 long beep sound.
 - Memory channel number blinks.
- ③ Rotate [DIAL] to select the desired memory channel.
 - All channels are displayed.
 - Push [VFO] to return to memory mode indication.

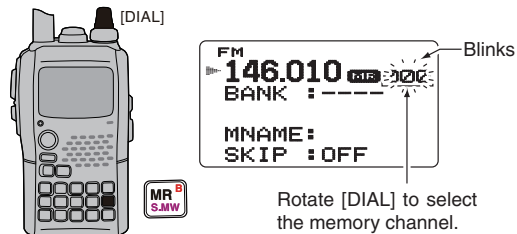

◇ Using the KEYPAD

- ① Push [MR] to select memory mode.
- ② Use the keypad to enter 3 digits to select the desired memory channel.
 - The blank channels are also selectable.

• Example— selecting memory channel “25”

Push [MR] then push [0], [2], [5].

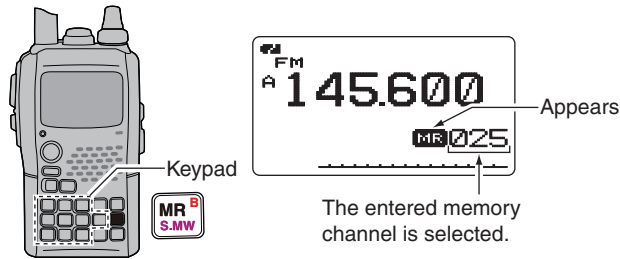

■ Selecting a call channel

- ① Push [CALL] to select call channel mode.
 - Pushing [CALL] toggles call, TV* and weather† channels.
- ② Rotate [DIAL] to select the desired call channel.
 - “C0” and “C1” are selectable.

/// *Appears only when TV channels are programmed via the optional RS-92. Also available for A band operation only.
 /// †Available for the U.S.A. version only.

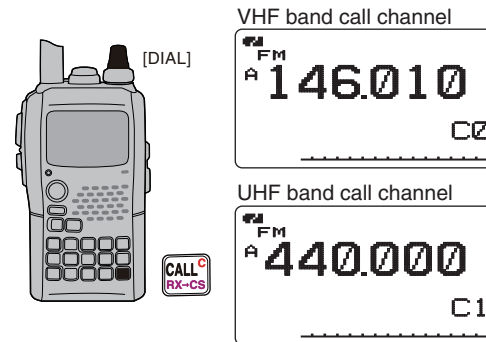

Memory channel programming

- ① Push **[VFO]** to select VFO mode.
- ② Set the desired frequency:
 - Select the desired band with **[BAND]**.
 - Set the desired frequency with **[DIAL]**.
 - Or set the desired frequency with keypad directly.
 - In this case, the band and frequency settings with **[BAND]** and **[DIAL]** as above are not required.
 - Set other data (e.g. offset frequency, duplex direction, tone squelch, etc.), if desired.
- ③ Push and hold **[S.MW](MR)** for 1 sec. to enter select memory write mode.
 - 1 short and 1 long beep sound.
 - Memory channel number blinks.
- ④ Rotate **[DIAL]** to select the desired channel.
 - Call channels (C0, C1), VFO (VFO) and scan edge channels (0A/0B to 24A/24B), as well as regular memory channels, can be programmed in this way.
- ⑤ Push and hold **[S.MW](MR)** for 1 sec. to program.
 - 3 beeps sound.
 - Memory channel number automatically increases when continuing to push and hold **[S.MW](MR)** for 1 sec. after programming.

[EXAMPLE]: Programming 145.870 MHz into memory channel 11 (blank channel).

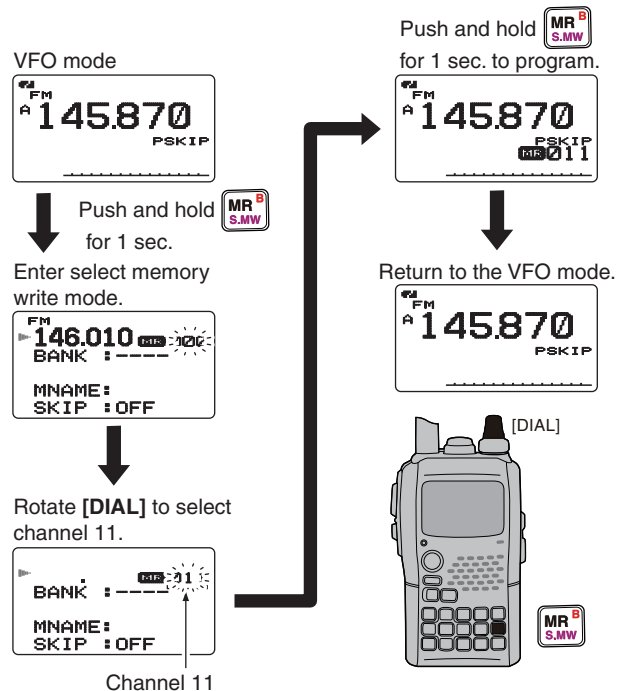

Memory bank setting

The IC-92AD has a total of 26 banks (A to Z). Regular memory channels, 000 to 799 (A band) / 000 to 399 (B band), are assigned to the desired bank for easy memory management.

- ① Push and hold **[S.MW](MR)** for 1 sec. to enter select memory write mode.
 - 1 short and 1 long beep sound.
 - Memory channel number blinks.
- ② Rotate **[DIAL]** to select the desired memory channel.
- ③ Push **[▲](2)** or **[▼](8)** to select “BANK.”
 - Bank group and channel number is displayed if the selected memory channel has already been previously assigned to a bank.

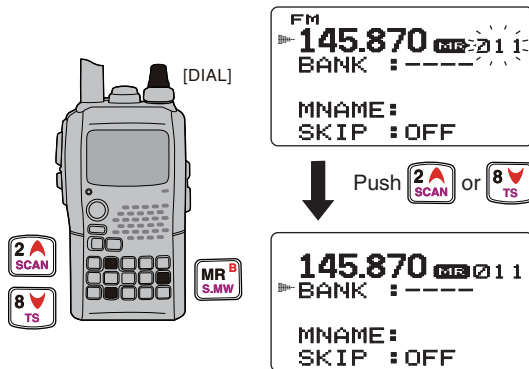

- ④ Push **[◀](4)** or **[▶](6)** to select the desired bank group (A–Z) or bank channel (0–99) digit.

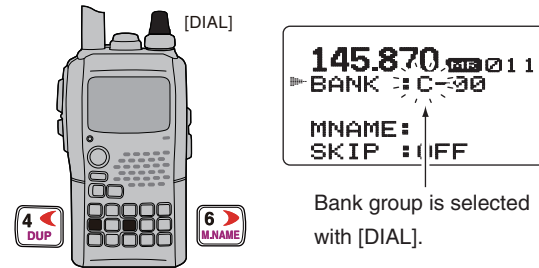

- ⑤ Rotate **[DIAL]** to select the bank group (from “A” to “Z”) or bank channel number (from “00” to “99”).

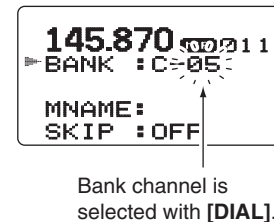

- ⑥ Push and hold **[S.MW](MR)** for 1 sec. to assign the channel to the bank.
 - Return to the previous indication.

Memory bank selection

- ① Push **[MR]** several times to select memory bank mode.
- ② While pushing and holding **[BAND]**, rotate **[DIAL]** to select the desired bank (A to Z).
 - Only programmed banks are displayed.
 - Pushing **[BAND]** also can be select the band.

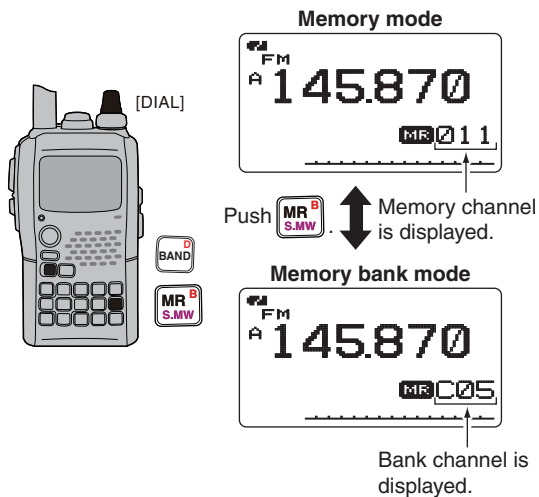

- ③ Rotate **[DIAL]** to select the bank channel.
 - Only programmed channels are displayed.

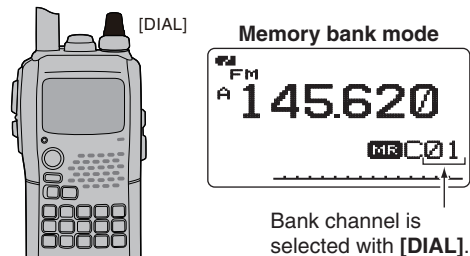

- ④ Push **[MR]** to return to regular memory condition.

■ Programming memory/bank/scan name

Each memory channel can be programmed with an alphanumeric channel name for easy recognition and can be indicated independently by channel. Names can be a maximum of 8 characters.

/// **NOTE:** Scan name indication can be turned ON or OFF in display set mode. (p. 114)

- ① Push **[MR]** to select memory mode.
 - When programming a call channel name, push **[CALL]** to select call channel mode.
- ② Rotate **[DIAL]** to select the desired memory channel.
 - Select scan edge channels (0A/0B to 24A/24B) for programming a scan name.
- ③ Push and hold **[S.MW](MR)** for 1 sec. to enter select memory write mode.
 - 1 short and 1 long beep sound.
 - Memory channel number blinks.
- ④ Push **[▲](2)** or **[▼](8)** several times to select “BNAME,” “MNAME” or “SNAME” when programming the bank name, the memory name or the scan name, respectively.
 - After selecting the name to be programmed, a cursor blinks for the first character.
- ⑤ Rotate **[DIAL]** to select the desired character.
 - The selected character blinks.
 - Push **[A/a](3)** to change the character group from “AB” (alphabetical characters; capital letters), “ab” (alphabetical characters; lower case letters), “12” (numbers) and “! ” (symbols) in sequence.

- Push **[▶](6)** to move the cursor right; push **[◀](4)** to move the cursor left.
 - Push **[CLR](1)** to erase the selected character, or push and hold **[CLR](1)** for 1 sec. to erase all characters following the cursor.
- ⑥ Repeat step ⑤ until the desired channel name is programmed.
 - ⑦ Push and hold **[S.MW](MR)** for 1 sec. to program the name and exit channel name programming.
 - 3 beeps sound.

/// **NOTE:** Only one bank name can be programmed into each bank. Therefore, the previously programmed bank name will be displayed when bank name indication is selected. Also, the programmed bank name is assigned for the other bank channels automatically.

◇ Available characters

ABCDEFGHIJKLMN OPQRSTUVWXYZ
abcdefghijklmnopqr stuvwxyz
0123456789
! " # \$ % & ' () * + , - . / : ; < = > ? @ [\]
^ _ ` { } ~ (Space)

9 MEMORY/CALL CHANNELS

[EXAMPLE]: Programming the bank name “AIR” into the scan edge channel 03A.

Push to select memory mode.



Rotate [DIAL] to select scan edge channel 03A.

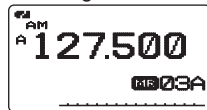

Push and hold for 1 sec.

Enter select memory write mode.



Scan edge channel “03A”

*Select “MNAME” or “SNAME” when programming the memory name or the scan name, respectively.

Push or to select “BNAME” *.



Rotate [DIAL] to enter “A”, push .



Enter “1” and “R” with [DIAL] and .



Push and hold for 1 sec. to program.

■ Selecting memory/bank name indication

During memory mode operation, either the programmed memory name or bank name can be displayed below the frequency indication.

NOTE: The programmed scan name is displayed during the programmed scan edge channel selection.

- ① Push [MR] to select memory mode.
- ② While pushing [M.NAME](6), rotate [DIAL] to select display indication type from memory name (normal size), memory name (large size), bank name and OFF.
 - Push and hold [M.NAME](6) for 1 sec. can be also selectable.

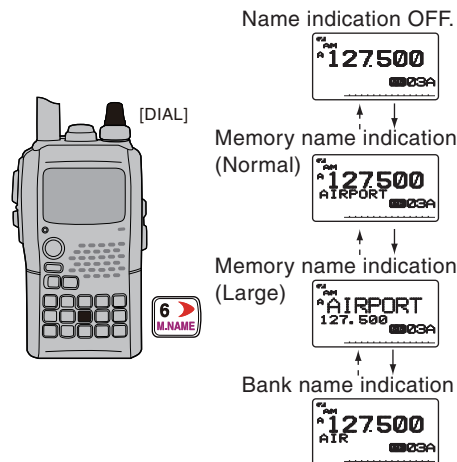

■ Copying memory/call contents

This function transfers a memory channel's contents to VFO (or another memory/call channel). This is useful when searching for signals around a memory channel frequency and for recalling the offset frequency, subaudible tone frequency etc.

◇ Memory/call↔VFO

- ① Select the memory (call) channel to be copied.
 - ➔ Push **[MR]** or **[CALL]** to select memory mode or call channel mode, then rotate **[DIAL]** to select the desired channel.
- ② Push and hold **[S.MW](MR)** for 1 sec. to enter select memory write mode.
 - 1 short and 1 long beep sound.
 - Memory channel number blinks.
- ③ Rotate **[DIAL]** to select "VFO."
- ④ Push and hold **[S.MW](MR)** for 1 sec. to write the selected channel contents to VFO mode.
 - Returns to VFO mode automatically.

[EXAMPLE]: Copying memory channel 11 to VFO.

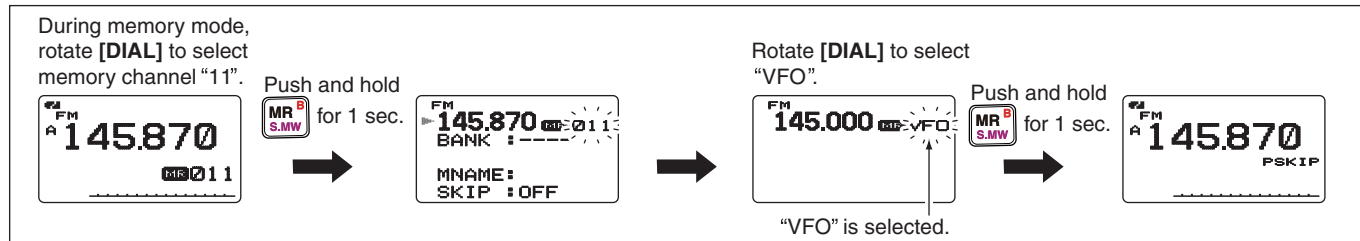

/// Holding **[S.MW](MR)** for 2 sec. at the step ②, will also copy the memory contents to VFO. In this case, the steps ③ and ④ are not necessary.

◇ Memory/call↔memory/call

- ① Select the memory (call) channel to be copied.
 - ➔ Push **[MR]** or **[CALL]** to select memory mode or call channel mode, then rotate **[DIAL]** to select the desired memory channel.
- ② Push and hold **[S.MW](MR)** for 1 sec. to enter select memory write mode.
 - 1 short and 1 long beep sound.
 - Memory channel number blinks.
 - Do not hold **[S.MW](MR)** for more than 2 sec. otherwise the memory contents will be copied to VFO.
- ③ Rotate **[DIAL]** to select the target memory (call) channel.
- ④ Push and hold **[S.MW](MR)** for 1 sec. again to copy.

Memory clearing

Contents of programmed memories can be cleared (erased), if desired.

- ① Push and hold **[S.MW](MR)** for 1 sec. to enter select memory write mode.
 - 1 short and 1 long beeps sound.
 - Memory channel number blinks.
 - Do not hold **[S.MW](MR)** for more than 2 sec. otherwise the memory contents will be copied to VFO.
- ② Rotate **[DIAL]** to select the desired memory channel to be cleared.
- ③ Push **[▲](2)** or **[▼](8)** to select “CLEAR.”
- ④ Push and hold **[S.MW](MR)** for 1 sec. to clear the contents.
 - 3 beeps sound.
 - The cleared channel changes to blank channel
 - Return to select memory write mode.— Memory channel number blinks. Push **[VFO]** to exit select memory write mode.

NOTE: Be careful!— the contents of cleared memories **CANNOT** be recalled.

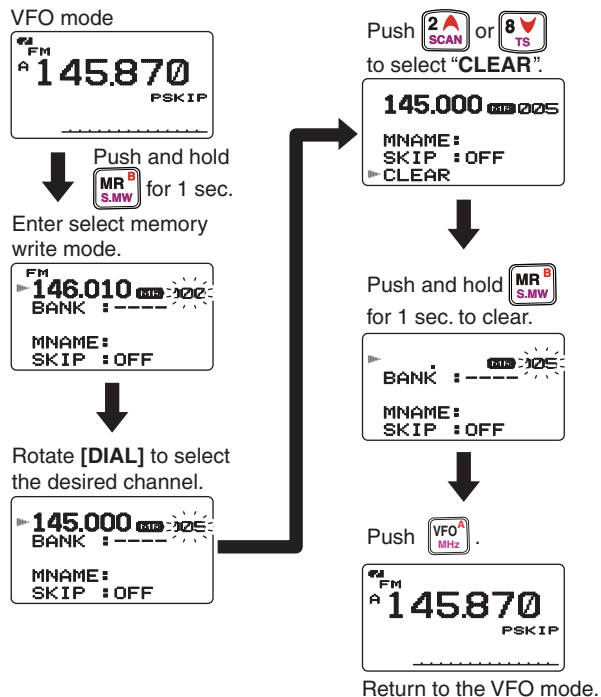

Erasing/transferring bank contents

The bank contents of programmed memory channels can be cleared or reassigned to another memory bank.

INFORMATION: Even if the memory bank contents are cleared, the memory channel contents still remain programmed.

- ① Select the desired bank contents to be transferred or erased from the bank. (p. 76)
 - ➔ Push **[MR]** several times to select memory bank mode.
 - ➔ While pushing **[BAND]**, rotate **[DIAL]** to select the desired memory bank group.
 - Pushing **[BAND]** also can be select the band.
 - ➔ Rotate **[DIAL]** to select the bank channel.

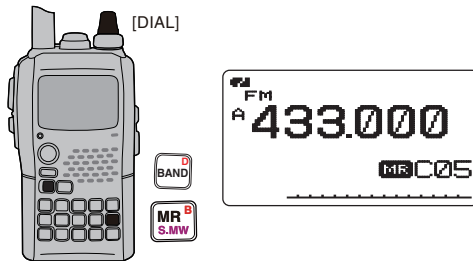

- ② Push **[S.MW](MR)** for 1 sec. to enter select memory write mode.
 - 1 short and 1 long beeps sound.
 - Displays the original memory channel number automatically and memory channel number blinks.
 - Do not hold **[S.MW](MR)** for more than 2 sec., otherwise the memory contents will be copied to VFO.

- ③ Push **[▲](2)** or **[▼](8)** several times to select “BANK.”
- ④ Push **[◀](4)** or **[▶](6)** to select the desired bank group or bank channel to be transferred.
- ⑤ Rotate **[DIAL]** to select the desired bank group or channel.
 - Select “----” indication when erasing the contents from the bank.

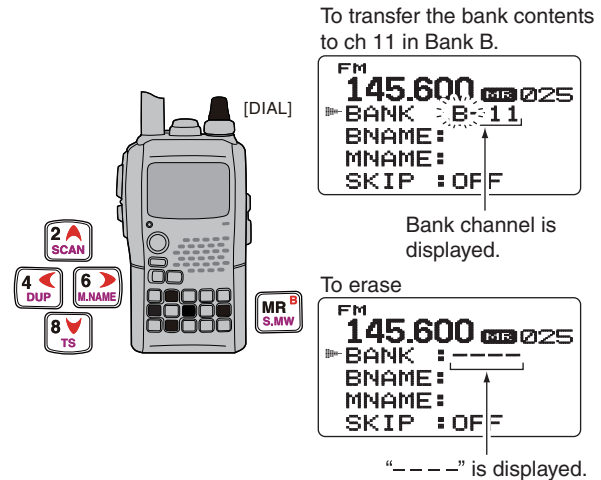

- ⑥ Push **[S.MW](MR)** for 1 sec. to erase/transfer the bank contents.

10 SCAN OPERATION

■ Scan types

Scanning searches for signals automatically and makes it easier to locate new stations for contact or listening purposes.

FULL SCAN (p. 83)

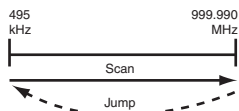

Repeatedly scans all frequencies over the entire band. Some frequency ranges are not scanned according to the frequency coverage of the transceiver's version.

PROGRAMMED SCAN (p. 83)

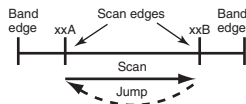

Repeatedly scans between two user-programmed frequencies. Used for checking for frequencies within a specified range such as repeater output frequencies, etc.

ALL/SELECTED BANK SCAN (p. 86)

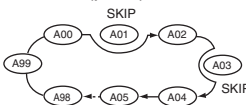

Repeatedly scans all bank channels or selected bank channels. The skip scan is also available.

PROGRAMMED LINK SCAN (p. 83)

Repeatedly programmed scans user-programmed frequencies selected at P-LINK items in the menu mode.

SELECTED BAND SCAN

(p. 83)

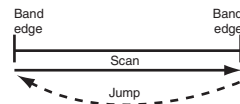

Repeatedly scans all frequencies over the entire selected band.

MEMORY (SKIP) SCAN

(p. 85)

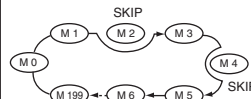

Repeatedly scans memory channels except those set as skip channel. Skip channels can be turned ON and OFF by pushing and holding **[SKIP](5)** in memory mode.

FREQUENCY/MEMORY SKIP FUNCTION (p. 87)

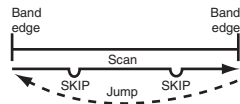

Skips unwanted frequencies or channels that inconveniently stop scanning. This function can be turned ON and OFF by pushing and holding **[SKIP](5)** in either VFO or memory mode.

BAND MEMORY (SKIP) SCAN (p. 85)

Repeatedly scans memory channels same band as displaying band.

MODE MEMORY (SKIP) SCAN (p. 85)

Repeatedly scans memory channels same mode as displaying mode.

BANK-LINK SCAN (p. 86)

Repeatedly scans bank channels selected at BANK-LINK items in the menu mode.

■ Full/band/programmed scan

- ① Push [VFO] to select VFO mode.
 - Select the desired frequency band with [BAND], if desired.
- ② Set the squelch level.
- ③ While pushing and holding [SCAN](2), rotate [DIAL] to select the desired scanning type.
 - “ALL” for full scan; “BAND” for band scan, “P-LINK” for programmed link scan, “PROG-xx (or scan name if programmed)” for programmed scan (xx= 0 to 24; programmed scan edges numbers are only displayed), “DUP” (appears only when duplex operation is set) for duplex scan.



• Full scan selection

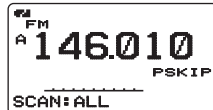

• Band scan selection

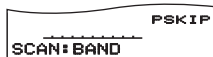

• Programmed link scan selection

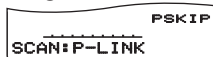

• Programmed scan selection



Selectable between “00” to “24” if programmed.

- ④ To start the scan, release [SCAN](2).
 - Scan pauses when a signal is received.
 - Rotate [DIAL] to change the scanning direction, or resumes manually.
 - Push [VFO] to stop the scan.
- During full/band scan
 - During programmed scan

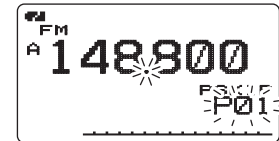

/// **About the scanning steps:** The selected tuning step in each frequency band (in VFO mode) is used during scan.

/// **Duplex scan function:** Repeatedly scans two frequencies (transmission/reception) during duplex scan operation.

Scan name selection



Scan name

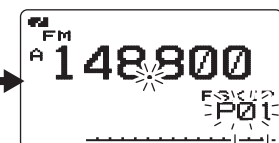

Scan edge number

Scan name is not displayed during a programmed scan.

10 SCAN OPERATION

■ Scan edges programming

Scan edges can be programmed in the same manner as memory channels. Scan edges are programmed into scan edges, 00A/00B to 24A/24B, in memory channels.

- ① Push **[VFO]** to select VFO mode.
- ② Set the desired frequency:
 - ➔ Select the desired band with **[BAND]**.
 - ➔ Set the desired frequency with **[DIAL]**.
 - ➔ Program different frequencies in “**A” and “**B” respectively.
 - ➔ Set other data (e.g. offset frequency, duplex direction, tone squelch, etc.), if desired.
- ③ Push and hold **[S.MW](MR)** for 1 sec. to enter the select memory write mode.
 - 1 short and 1 long beeps sound.
 - Memory channel number blinks.
- ④ Rotate **[DIAL]** to select the desired programmed scan edge channel from 00A to 24A.

- ⑤ Push and hold **[S.MW](MR)** for 1 sec.
 - 3 beeps sound.
 - The other scan edge channel “B,” 00B to 24B, is automatically selected when continuing to push **[S.MW](MR)** after programming.
- ⑥ To program a frequency for the other pair of scan edges, 00B to 24B, repeat steps ② and ④.
 - If the same frequency is programmed into a pair of scan edges, programmed scan will not function.

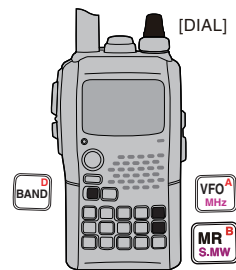

[EXAMPLE]: Programming 145.300 MHz into scan edges 03A.

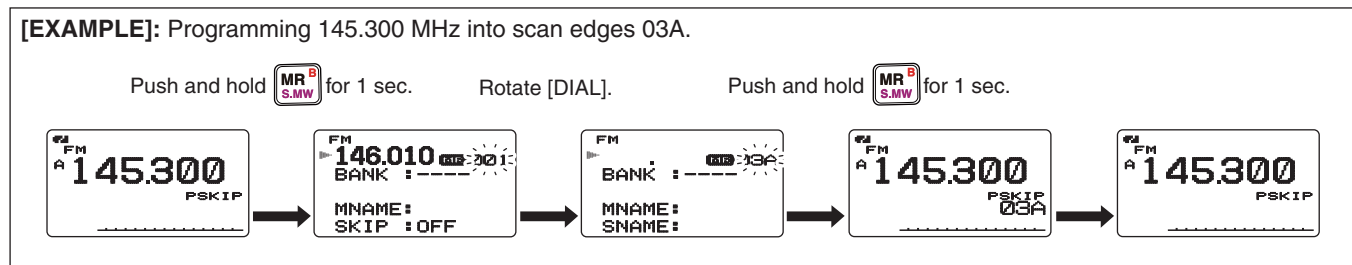

Memory scan

IMPORTANT!: To perform memory scan, 2 or more memory channels **MUST** be programmed, otherwise the scan will not start.

- ① Push **[MR]** to select memory mode.
- ② Set the squelch level.
- ③ While pushing and holding **[SCAN](2)**, rotate **[DIAL]** to select the desired scanning type.
 - “ALL” for full memory scan; “BAND” for band memory scan, “MODE” for mode scan, “DUP” (appears only when duplex operation is set) for duplex scan.

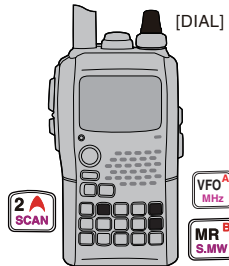

• **All memory scan selection**

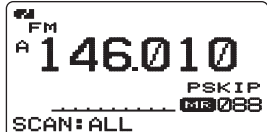

• **Band memory scan selection**

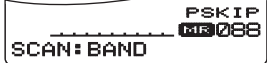

• **Mode scan selection**

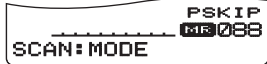

• **Duplex scan selection**

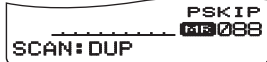

- ④ Release **[SCAN](2)** to start the selected scan.
 - Scan pauses when a signal is received.
 - Rotate **[DIAL]** to change the scanning direction, or resumes manually.
- ⑤ To stop the scan, push **[VFO]**.

• **During memory scan**

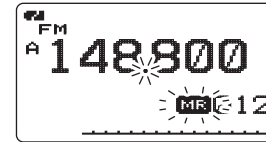

Band memory scan function: Repeatedly scans all memory channels programmed with any frequencies of the band programmed in the memory channel selected for scanning.

Mode scan function: Repeatedly scans all memory channels in which the same operating mode as the selected memory channel has been programmed.

Duplex scan function: Repeatedly scans two frequencies (transmission/reception) during duplex scan operation.

10 SCAN OPERATION

Memory bank scan

IMPORTANT!: To perform memory bank scan, 2 or more bank channels **MUST** be programmed, otherwise the scan will not start.

- 1 Push **[S.MW](MR)** several times to select memory bank mode.
- 2 Set the squelch level.
- 3 While pushing and holding **[SCAN](2)**, rotate **[DIAL]** to select the desired scanning type.
 - “ALL” for all bank scan; “BANK-LINK” for bank link scan or “BANK-x” for bank scan (x= A to Z; programmed bank groups are only displayed.), “DUP” (appears only when duplex operation is set) for duplex scan.

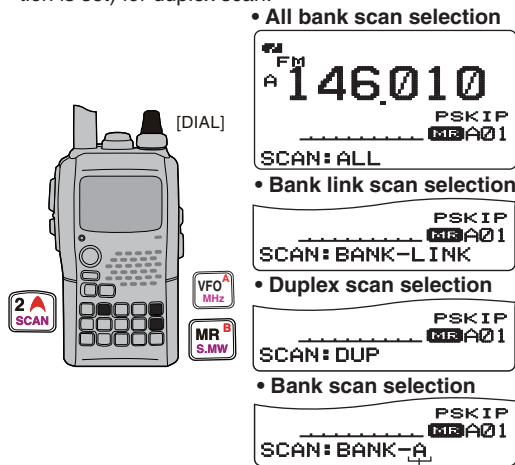

Selectable between “A” to “Z” if programmed.

- 4 Release **[SCAN](2)** to start the selected scan.
 - Scan pauses when a signal is received.
 - Rotate **[DIAL]** to change the scanning direction, or resumes manually.
- 5 To stop the scan, push **[VFO]**.

• During all bank/bank link scan • During bank scan

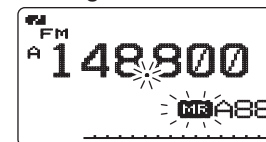
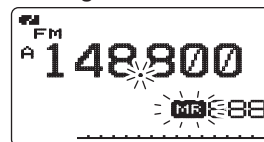

The bank-link setting can be changed in scan set mode. See page 109 for details.

Duplex scan function: Repeatedly scans two frequencies (transmission/reception) during duplex scan operation.

Memory bank scan skips any memory channels in the selected bank that are set to “SKIP” or “PSKIP”.
Memory bank scan stops at the first channel when all channels in a bank are set to “SKIP” or “PSKIP”.

■ Skip channel/frequency setting

Memory channels can be set to be skipped during memory skip scan. In addition, memory channels can be set to be skipped during both memory skip scan and frequency skip scan. This is useful to speed up the scan rate.

- ① Select a memory channel:
 - ➔ Push **[MR]** to select memory mode.
 - ➔ Rotate **[DIAL]** to select the desired channel to be a skip channel/frequency.

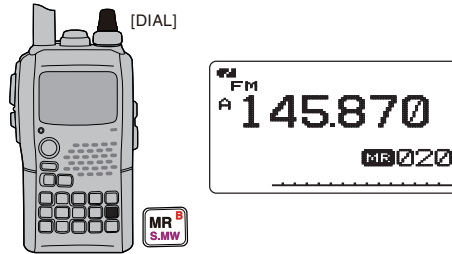

- ② Push and hold **[S.MW](MR)** for 1 sec. to enter select memory write mode.

- ③ Push **[▲](2)** or **[▼](8)** several times to select “SKIP”

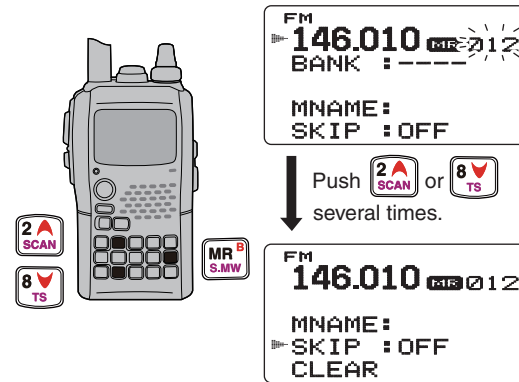

- ④ Rotate **[DIAL]** to select the skip condition from “SKIP,” “PSKIP” or “OFF” for the selected channel.
 - PSKIP : The channel is skipped during memory/bank scan and the programmed frequency is skipped during VFO scan, such as programmed scan.
 - SKIP : The channel is skipped during memory or bank scan.
 - OFF : The channel is scanned during any scan.

(Continue to the next page.)

10 SCAN OPERATION

- ⑤ Push and hold **[S.MW](MR)** for 1 sec. to store the skip condition into the memory.

- “SKIP” or “PSKIP” indicator appears, according to the skip selection in the step ④.

• Skip channel setting

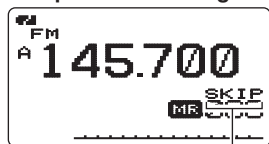

“SKIP” appears

• Program skip setting



“PSKIP” appears

✓ **CONVENIENT!**

The skip setting can be set with the following operation.

- ① Select the desired memory channel to be set as a skip channel/frequency.
- ② While pushing **[SKIP](5)**, rotate **[DIAL]** to select the skip condition from “PSKIP,” “SKIP” and “OFF (no indication).”

✓ **CONVENIENT!**

During VFO scanning, such as programmed scan, the skip setting can be programmed into the highest blank memory channel which is automatically selected with the following operation.

- ① Start the VFO scan.
 - ➔ Push **[VFO]** to select VFO mode.
 - Select the desired frequency band with **[BAND]**, if desired.
 - ➔ Set the squelch level.
 - ➔ While pushing and holding **[SCAN](2)**, rotate **[DIAL]** to select the desired scan type.
 - “ALL” for full scan; “BAND” for band scan, “P-LINK” for programmed link scan, “PROG-xx (or scan name if programmed)” for programmed scan (xx= 0 to 24; programmed scan edges numbers are only displayed), “DUP” for duplex scan.
 - ➔ To start the scan, release **[SCAN](2)**.
 - Scan pauses when a signal is received.
 - Rotate **[DIAL]** to change the scanning direction, or resumes manually.
- ② When scan pauses and you want to set the paused frequency as a skip frequency.
 - ➔ Push and hold **[SKIP](5)** for 1 sec. to store the paused frequency into the highest blank memory channel.
 - While pushing and holding **[SKIP](5)**, scan pauses; and when releasing **[SKIP](5)** scan resumes.

■ Scan resume condition

◇ Scan pause timer

The scan pauses when receiving signals according to the scan pause time. It can be set from 2 to 20 sec. or unlimited.

- ① Enter “PAUSE TIMER” in scan set mode. (p. 108)

⟨MENU screen⟩ ⇄ ⟨SCAN⟩ ⇄ ⟨PAUSE TIMER⟩
 (Push [MENU/TUNING]) (Rotate [DIAL]†, then push [←](5)‡.)

- ② Rotate [DIAL]† to set the desired scan pausing time from 2–20 sec. (2 sec. steps) or “HOLD.”
 - “2SEC”–“20SEC”: Scan pauses for 2–20 sec. while receiving a signal.
 - “HOLD” : Scan pauses on a received a signal until it disappears.
- ③ Push [←](5) (or [↩](4)) to return to scan set mode.
- ④ [MENU/TUNING] to return to frequency indication.

• Pause timer setting

```

PAUSE TIMER
 4SEC
 6SEC
 8SEC
▼ 10SEC
 12SEC
    
```

◇ Scan resume timer

The scan restarts after the signal disappears according to the resume time. It can be set from 0–5 sec. or unlimited.

- ① Enter “RESUME TIMER” in scan set mode. (p. 108)

⟨MENU screen⟩ ⇄ ⟨SCAN⟩ ⇄ ⟨RESUME TIMER⟩
 (Push [MENU/TUNING]) (Rotate [DIAL]†, then push [←](5)‡.)

- ② Rotate [DIAL]† to set the desired scan resume time from 0–5 sec. (1 sec. steps) and “HOLD.”
 - “0SEC” : Scan restarts immediately after the signal disappears.
 - “1SEC”–“5SEC” : Scan restarts 1–5 sec. after the signal disappears.
 - “HOLD” : Scan restarts by rotating [DIAL] only.
- ③ Push [←](5) (or [↩](4)) to return to scan set mode.
- ④ [MENU/TUNING] to return to frequency indication.

• Resume timer setting

```

RESUME TIMER
 1SEC
▼ 2SEC
 3SEC
 4SEC
 5SEC
    
```

/// Scan resume timer must be set shorter than the scan pause timer, otherwise this timer does not activate.

†[DIAL] ↔ [▲](2)/[▼](8) ‡[←](5) ↔ [▶](6)

11 PRIORITY WATCH

Priority watch types

Priority watch checks for signals on the frequency every 5 sec. while operating on a VFO frequency or scanning. The transceiver has 3 priority watch types to suit your needs.

The watch resumes according to the selected scan resume condition. See page 89 for details.

NOTE: If the pocket beep function is activated, the transceiver automatically selects the tone squelch function when priority watch starts.

◇ About priority beep function

When receiving a signal on the priority frequency, you can be alerted with beeps and a blink “(•)”. This function can be activated when setting the priority watch function ON.

MEMORY/CALL CHANNEL WATCH

While operating on a VFO frequency, priority watch checks for a signal on the selected channel every 5 sec.

- A memory channel with skip information can be watched.

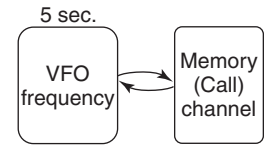

MEMORY SCAN WATCH

While operating on a VFO frequency, priority watch checks for signals on each memory channel in sequence.

- The memory skip function and/or memory bank scan is useful to speed up the scan.

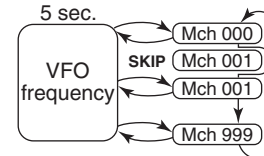

VFO SCAN WATCH

While scanning in VFO mode, priority watch checks for signals on the selected channel every 5 sec.



Priority watch operation

Although [DIAL] and [←](5) are used for description in this section, [▲](2)/[▼](8) and [▶](6) are available instead of [DIAL] and [←](5).

◇ **Memory/call channel and memory scan watch**

- ① Select VFO mode; then, set an operating frequency.
- ② Select the channel(s) to be watched.
 - For memory channel watch:**
Select the desired memory channel.
 - For call channel watch:**
Select the desired call channel.
 - For memory scan watch:**
Select memory mode, or the desired bank group; then, push and hold [SCAN](2) for 1 sec. to start memory/bank scan.
- ③ Enter "PRIO WATCH" in scan set mode. (p. 108)

◀MENU screen▶ ↔ ◀SCAN▶ ↔ ◀PRIO WATCH▶
(Push [MENU/↻](0)) (Rotate [DIAL]†, then push [←](5)‡.)

- ④ Rotate [DIAL]† to select "ON."
 - Select "BELL" if the priority beep function is desired.
- ⑤ Push [MENU/↻](0) to exit scan set mode and start the watch.
 - "PRIO" indicator appears.
 - The transceiver checks the memory/bank channel(s) or call channel every 5 sec.
 - The watch resumes according to the selected scan resume condition. (p. 89)
- ⑥ Push [VFO] to cancel the watch.

• **During priority watch**

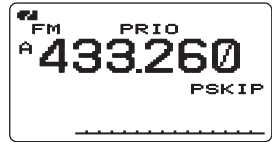

Monitors VFO frequency for 5 sec.

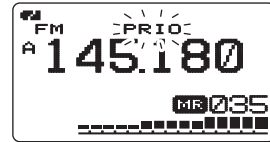

Pauses on a memory or call channel when a signal is received.

• **During priority watch with priority beep**

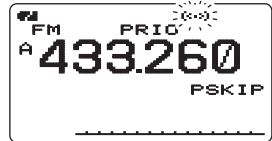

Emits beep and blinks "(*)" indicator when a signal is received on a memory or call channel.

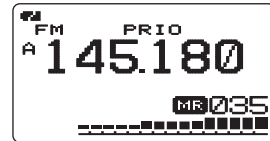

†[DIAL] ↔ [▲](2)/[▼](8) ‡[←](5) ↔ [▶](6)

11 PRIORITY WATCH

◇ VFO scan watch

- ① Select the channel(s) to be watched.

For memory channel watch:

Select the desired memory channel.

For call channel watch:

Select the desired call channel.

For memory scan watch:

Select memory mode, or the desired bank group; then, push and hold **[SCAN](2)** for 1 sec. to start memory/bank scan.

- ② Enter "PRIO WATCH" in scan set mode. (p. 108)

⟨MENU screen⟩ ⇄ ⟨SCAN⟩ ⇄ ⟨PRIO WATCH⟩
(Push **[MENU/TT-O]**) (Rotate **[DIAL]†**, then push **[←](5)‡**.)

- ③ Rotate **[DIAL]†** to select "ON."
• Select "BELL" if the priority beep function is desired.
- ④ Push **[VFO]** to exit scan set mode and start the watch.
• "PRIO" indicator appears.
- ⑤ Push and hold **[SCAN](2)** for 1 sec. to enter scan type selection.
- ⑥ Rotate **[DIAL]** to select the desired scan type from "ALL," "BAND" and "PROG-xx (xx= 0-24)," "DUP."
- ⑦ Release **[SCAN](2)** to start the VFO scan watch.
• The transceiver checks the memory/bank channel(s) or call channel every 5 sec.
• The watch resumes according to the selected scan resume condition. (p. 89)

- ⑧ Push **[VFO]** to cancel the watch.

• During priority watch

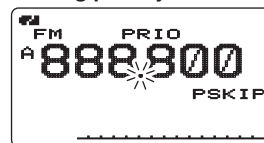

Searches VFO frequencies for 5 sec.



Pauses on a memory or call channel when a signal is received.

• During priority watch with priority beep

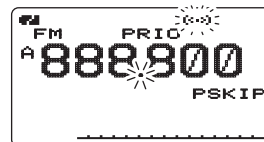

Emits beep and blinks "(•)" indicator when a signal is received on a memory or call channel.



†**[DIAL]** ⇄ **[A](2)/[M](8)**

‡**[←](5)** ⇄ **[▶](6)**

■ General

MENU screen is used for programming infrequently changed values or conditions of functions.

◇ Entering MENU screen and operation

e.g.) Set "AUTO power OFF" to 30 minutes.

① Push [MENU/TS] to enter MENU screen.

- MENU groups appear.

```
***** MENU *****
▶ MESSAGE/POS
  SET MODE
  SCAN
  DUP/TONE...
  DISPLAY
```

② Rotate [DIAL][†] to select the desired menu group, then push [←](5)[†].

- Setting items appear.

```
SET MODE
▶ AP OFF
  POWER SAVE
  ATTENUATOR
  MONITOR
  DIAL SPEED
```

③ Rotate [DIAL][†] to select the desired item, then push [←](5)[†].

```
AUTO POWER OFF
▶ OFF
  30MIN
  60MIN
  90MIN
  120MIN
```

④ Rotate [DIAL][†] to select the desired value or condition, then push [←](5) to return to the setting item selection mode.

```
AUTO POWER OFF
OFF
▶ 30MIN
  60MIN
  90MIN
  120MIN
```

⑤ Push [MENU/TS] to return to frequency indication, re-peat steps ② to ④ to set another items.

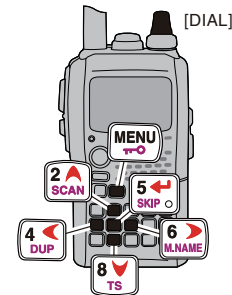

[†][DIAL] ↔ [A](2)/[V](8) [‡][←](5) ↔ [→](6)

12 MENU SCREEN OPERATION

■ MENU screen indication for A band

While A band is selected, MENU screen shows following indication.

```

***** MENU *****
MESSAGE/POS
SET MODE
SCAN
▷ DUP/TONE. . .
DISPLAY
    
```

MENU screen indication for A band.

■ MENU screen indication for B band

While B band is selected, MENU screen shows following indication.

```

***** MENU *****
RX CALL S
MESSAGE/POS
DV VOICE M
▷ SET MODE
DV SET MODE
    
```

MENU screen indication for B band.

■ Menu list

MENU	REF.	MENU	REF.
CALL SIGN ^{†,*}	—	DV SET MODE*	pgs. 100–107
RX CALL SIGN ^{†,*}	—	SCAN	pgs. 108, 109
MESSAGE/POSITION [†]	—	DUP/TONE...	pgs. 110–112
DV VOICE MEMO ^{†,*}	—	DISPLAY	pgs. 112–114
SET MODE	pgs. 96–99	SOUNDS	pgs. 115, 116

[†]Refer to the chapter 7 and 8 for details.

*B BAND only.

■ Items list

◇ Set mode

ITEMS	REF.	ITEMS	REF.
AUTO POWER OFF	p. 96	AUTO POWER ON	p. 98
POWER SAVE	p. 96	LOCK	p. 98
ATTENUATOR	p. 96	PTT LOCK	p. 99
MONITOR	p. 97	BUSY LOCKOUT	p. 99
DIAL SPEED-UP	p. 97	TIME-OUT TIMER	p. 99
AUTO REPEATER	p. 97	ACTIVE BAND	p. 99
MIC SIMPLE MODE	p. 98	DIAL REPLACE	p. 99
WEATHER ALERT	p. 98		

◇ DV set mode

Available for B band.

ITEMS	REF.	ITEMS	REF.
AUTO REPLY	p. 100	VTG	p. 103
DIGITAL CODE	p. 100	GSV	p. 103
DV DATA TX	p. 100	➔ GPS-A SET MODE	p. 103
DIGITAL MONITOR	p. 101	➔ UNPROTO ADDRESS	p. 103
DIGITAL RPT SET	p. 101	DATA EXTENSION	p. 104
RXCALL WRITE	p. 101	TIME STAMP	p. 104
RXRPT WRITE	p. 101	GPS-A SYMBOL	p. 105
GPS TX MODE	p. 102	COMMENT	p. 105
➔ GPS SENTENCE	p. 103	GPS AUTO TX	p. 106
➔ RMC	p. 103	DV AUTO DETECT	p. 106
GGA	p. 103	EDIT RECORD	p. 106
GLL	p. 103	BK	p. 106
GSA	p. 103	EMR	p. 107

◇ Scan set mode

ITEMS	REF.	ITEMS	REF.
PRIO WATCH [‡]	p. 108	BANK LINK	p. 109
PAUSE TIMER	p. 108	➔ BANK-A	p. 109
RESUME TIMER	p. 108	PSCAN LINK	p. 109
		➔ PSCAN-00	p. 109

[‡]Not available during the TV band or weather channel mode selection.

◇ DUP/TONE set mode

Not available for the TV and weather channel mode.

ITEMS	REF.	ITEMS	REF.
OFFSET FREQ	p. 110	DTCS POLARITY	p. 111
REPEATER TONE	p. 110	DTMF SPEED	p. 111
CTCSS TONE	p. 110	DTMF TX KEY	p. 112
DTCS CODE	p. 111		

◇ DISPLAY set mode

ITEMS	REF.	ITEMS	REF.
BACKLIGHT	p. 112	SCROLL	p. 114
BUSY LED	p. 112	SCAN NAME	p. 114
LCD CONTRAST	p. 113	OPENING LOGO	p. 114
RX CALL SIGN* ¹	p. 113	OPENING CALL S* ¹	p. 114
TX CALL SIGN* ¹	p. 113	FONT SIZE	p. 114
RX MESSAGE* ¹	p. 113		

*¹Available for B band.

◇ SOUNDS set mode

ITEMS	REF.	ITEMS	REF.
BEEP LEVEL	p. 115	VOLUME SELECT	p. 115
KEY-TOUCH BEEP	p. 115	STANDBY BEEP* ¹	p. 116
SCAN STOP BEEP	p. 115	SUB BAD MUTE	p. 116
SCOPE AF OUTPUT	p. 115		

*¹Available for B band.

12 MENU SCREEN OPERATION

■ Set mode items

◇ Auto power OFF

The transceiver can be set to automatically turn OFF after a specified time period with a beep when no key operations are performed.

30 min., 60 min, 90 min, 120 min and OFF (default) can be specified. The specified time period is retained even when the transceiver is turned OFF by the auto power OFF function. To cancel the function, select "OFF" in this item.

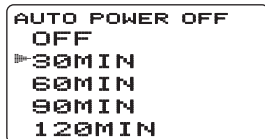
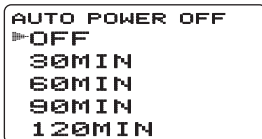

◇ Power save

The power save function reduces the current drain to conserve battery power. This power save function can be turned OFF, if desired, by turning power ON and OFF.

- "AUTO1" selects "1:4" duty ratio when receiving no signal for 5 sec., then "1:8" 15 sec. after that.
- "AUTO2" suppresses the consumption of the battery by stopping the operation of a digital block of the DV mode in addition to the operation of Auto1.

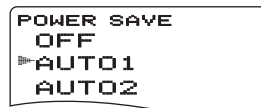

NOTE: Power save function is disable when using the external power supply (More than 10 V DC) or if the Auto replay function is set to ON or VOICE (p. 100).

◇ Attenuator

The attenuator prevents distortion of a desired signal by very strong RF signals near the desired frequency or when very strong electric fields, such as from a broadcasting station, are present at your location.

Select the attenuator function ON and OFF (default).



◇ **Monitor key action**

The monitor key, [SQL], can be set as a 'sticky' key. When set to the sticky condition, each push of [SQL] toggles the monitor function ON and OFF.

- PUSH: Pushing and holding [SQL] to monitor the frequency. (default)
- HOLD: Push [SQL] momentarily to monitor the frequency and push momentarily again to cancel it.



◇ **Dial speed acceleration**

The dial speed acceleration automatically speeds up the tuning dial speed when rotating [DIAL] rapidly.

- OFF : The dial speed acceleration is turned OFF.
- ON : The dial speed acceleration is tuned ON. (default)



◇ **Auto repeater**

U.S.A. version only

The auto repeater function automatically turns ON or OFF the duplex operation and tone encoder. The offset and repeater tone is not changed by the auto repeater function. Reset these frequencies, if necessary.

- OFF : The auto repeater function is turned OFF.
- RPT1 : Activates for duplex only. (default)
- RPT2 : Activates for duplex and tone.



12 MENU SCREEN OPERATION

◇ Microphone simple mode

Microphone simple mode is used to change the function assignments for keys on the optional HM-75A REMOTE CONTROL SPEAKER-MICROPHONE. (pgs. 137, 138)

- SIMPLE
- NORM-1 (default)
- NORM-2

```
MIC SIMPLE MODE
SIMPLE
▼NORM-1
NORM-2
```

```
MIC SIMPLE MODE
▼SIMPLE
NORM-1
NORM-2
```

◇ Weather alert function

U.S.A. version only

Turns weather alert function ON and OFF. (p. 128)

(default: OFF)

```
WEATHER ALERT
▼OFF
ON
```

```
WEATHER ALERT
OFF
▼ON
```

◇ Auto power ON

Auto power ON function turns the transceiver power ON automatically after passing the set time period from power OFF. Select the desired time period within 30 minutes to 24 hours in 30 minutes steps and OFF. (default: OFF)

```
AUTO POWER ON
OFF
```

```
AUTO POWER ON
24:00
```

◇ Key lock type

While the key lock function is ON, [PWR], [PTT], [SQL], [VOL] and [MENU] (Lock function only) can still be accessed. Accessible keys can be set to 1 of 4 groups.

- NORMAL : [PWR], [PTT], [SQL], [VOL] and [MENU] (Lock function only) accessible. (default)
- NO SQL : [PWR], [PTT], [VOL] and [MENU] (Lock function only) are accessible.
- NO VOL : [PWR], [PTT], [SQL] and [MENU] (Lock function only) are accessible.
- ALL : [PWR], [PTT] and [MENU] (Lock function only) are accessible.

```
LOCK
▼NORMAL
NO SQL
NO VOL
ALL
```

```
LOCK
NORMAL
▼NO SQL
NO VOL
ALL
```

◇ **PTT lock**

Turns the PTT lock function ON and OFF.
Transmission with [PTT] is inhibited when ON is selected to prevent accidental transmission, etc. (default: OFF)



◇ **Busy lockout**

Turns the busy lockout function ON and OFF.
This function inhibits transmission while receiving a signal or when the squelch is open. (default: OFF)



◇ **Time-out timer**

To prevent accidental prolonged transmission, etc., the transceiver has a time-out timer. This function cuts transmission OFF after 1, 3, 5 or 10 min. of continuous transmission. This timer can be cancelled.

- OFF : The time-out timer is turned OFF. (default)
- 1 to 10 MIN : The transmission is cut OFF after the set period elapses.

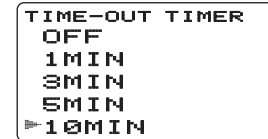
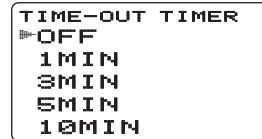

◇ **Active band**

Allows continuous frequency selection of the operating frequency across all bands.

- SINGLE : A single operating frequency can be selected within the current band. Push [BAND] for band selection in this case.
- ALL : The operating frequency can be selected continuously. (default)



◇ **Dial replace**

Exchanging [DIAL] and [VOL] function.

- OFF : The dial replace function is turned OFF. (default)
- ON : The dial replace function is turned ON.



12 MENU SCREEN OPERATION

■ DV set mode items

The following items are selectable for B band.

◇ Auto reply

This function replies to an individual station call even you are away from the transceiver.

After a manual transmission (pushing **[PTT]**), the Auto Reply setting returns to OFF automatically.

- **OFF** : No reply is performed even if a call is received. (default)
- **ON** : Sets the caller's call sign and replies to the call with the programmed own call sign.
- **VOICE** : Sets caller's call sign and replies to the call with the recorded audio in REPLY VOICE memory of DV VOICE MEMO.

```
AUTO REPLY
▷OFF
ON
VOICE
```

```
AUTO REPLY
OFF
ON
▷VOICE
```

/// **NOTE:** When "ON" or "VOICE" is set in the auto reply function, the power save function (p. 96) stop functioning automatically to receive call sign signal properly.

◇ Digital code

Sets the desired digital code for digital code squelch operation. Total of 100 codes (00–99) are available. (default: 00)

```
DIGITAL CODE
00
```

```
DIGITAL CODE
99
```

◇ DV data TX

During low-speed data operation, auto data transmission function is available. This function transmits when data has been input from PC via the **[DATA]** jack. (default: PTT)

```
DV DATA TX
▷PTT
AUTO
```

```
DV DATA TX
PTT
▷AUTO
```

- **PTT** : Data from [DATA/SP/MIC] transmits when [PTT] is pushed. (default)
- **AUTO** : Data from [DATA/SP/MIC] transmits automatically.

◇ **Digital monitor**

Sets the desired monitoring mode during digital mode operation from “Auto,” “Digital” and “Analog.”

- **AUTO** : The transceiver sets monitoring mode to FM and DV according to the received signal. (default)
- **DIGITAL** : Monitors in DV mode.
- **ANALOG** : Monitors in FM mode.



◇ **Digital repeater setting**

When accessing a digital repeater with a call sign different than is programmed, the repeater call sign can be stored into “RPT1” and/or “RPT2” automatically by reading the repeater’s transmission. The previously stored repeater’s call sign can be recalled when selecting the repeater call sign. (default: ON)



◇ **RX call sign auto write**

When an individual station call is received, the calling station call sign can be automatically set in “UR.” (default: OFF)

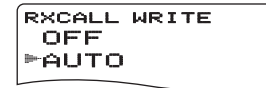
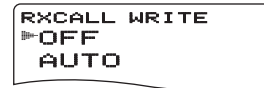

◇ **Repeater call sign auto write**

When accessing a repeater with a call sign different than is programmed, the repeater call sign can be set into “RPT1” and/or “RPT2” automatically by reading the repeater’s transmission. (default: OFF)

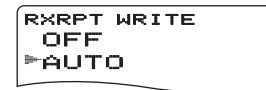
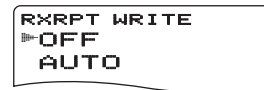

▨ The transceiver sets the received repeater call sign for operation, overwriting the previously set repeater call sign.

12 MENU SCREEN OPERATION

◇ GPS TX mode

Sets the transmission of data from a connected GPS receiver ON and OFF.

When the position information is received from a connected GPS receiver and the GPS Auto TX Timer setting (p. 106) is set to a specific time, the transceiver automatically transmits the current position and message at the set interval.

(default: DISABLE)

- **DISABLE** : Transmitting position data is disabled. (default)
- **GPS** : Transmitting position data in GPS mode.
- **GPS-A** : Transmitting position data in GPS-A mode.

```
GPS TX MODE
▷ DISABLE
GPS
GPS-A
```

```
GPS TX MODE
▷ DISABLE
GPS
▷ GPS-A
```

▷ : GPS-A SET

• Sentence formatter setting

- ① Select "GPS" in GPS TX mode item, then push [**←**](5)[†] to enter the sentence formatter selection.
- ② Rotate [**DIAL**][†] to select the desired sentence formatter.
 - RMC, GGA, GLL, GSA, VTG and GSV are selectable.

```
GPS SENTENCE
▷ RMC : OFF
GGA : ON
GLL : OFF
GSA : OFF
VTG : OFF
```

```
GPS SENTENCE
RMC : OFF
▷ GGA : ON
GLL : OFF
GSA : OFF
VTG : OFF
```

- ③ Push [**←**](5)[†] to enter the desired sentence formatter selection.
- ④ Rotate [**DIAL**][†] to select the setting.
 - See next page for details.

```
RMC SENTENCE
▷ OFF
ON
```

```
RMC SENTENCE
OFF
▷ ON
```

- ⑤ Push [**←**](5) or [**▷**](6) to select ON/OFF.
- ⑥ Rotate [**DIAL**][†] to select next sentence and repeat steps ② to ⑤, or push [**MENU/↵**](8) to return to frequency indication.
 - Only four sentence formatters can be activated at same time.

[†][**DIAL**] ↔ [**▲**](2)/[**▼**](8)

[‡][**←**](5) ↔ [**▷**](6)

- RMC : (Default OFF)
Set RMC sentence ON or OFF.
- GGA : (Default ON)
Set GGS sentence ON or OFF.
- GLL : (Default OFF)
Set GLL sentence ON or OFF.
- GSA : (Default OFF)
Set GSA sentence ON or OFF.
- VTG : (Default OFF)
Set VTG sentence ON or OFF.
- GSV : (Default OFF)
Set GSV sentence ON or OFF.

◇ GPS-A Set mode

Enter GPS-A operation set mode by selecting "GPS-A" in GPS TX mode, then push [←](5)‡. This set mode is available to set unproto address, data extension, time stamp, GPS-A symbol and comment.

```
GPS-A SET MODE
UNPROTO ADD
DATA EXTENS
TIME STAMP
GPS-A SYMBO
COMMENT
```

```
GPS-A SET MODE
UNPROTO ADD
DATA EXTENS
TIME STAMP
GPS-A SYMBO
COMMENT
```

◇ Unproto Address

56 characters address can be entered for unproto address.

- ① Push [←](5)‡ twice to enter the unproto address edit mode.
- ② Rotate [DIAL]† to select the desired character.
 - The selected character blinks.
 - Push [A/a](3) to change the character group from "AB" (alphabetical characters; capital letters), "ab" (alphabetical characters; lower case letters), "12" (numbers) and "!" (symbols) in sequence.
 - Push [▶](6) to move the cursor right; push [◀](4) to move the cursor left.
 - Push [CLR](1) to erase the selected character, or push and hold [CLR](1) for 1 sec. to erase all characters following the cursor.
- ③ Repeat step ② until the desired unproto address is programmed.
- ④ Push [←](5) to program the unproto address and exit the unproto address edit mode.
- ⑤ Push [◀](4) to return to GPS-A SET MODE screen mode.

```
UNPROTO ADDRESS
API92, DSTA
R*:
←: SET      : EDIT
←: BACK    ▶: CLR: CLR
```

```
UNPROTO ADDRESS
AB
PI92, DSTA
R*:
←: SET CLR: CLR
▲▼: SEL A/a: CHAR
◀▶: CUR
```

12 MENU SCREEN OPERATION

◇ DATA extension

Sets the data extension capability to "COURSE/SPEED" or OFF (default).

The transceiver's course and speed information is additionally transmitted with position data when "COURSE/SPEED" is selected.

/// **NOTE:** When "COURSE/SPEED" is selected, number of character for "COMMENT" is limited to 36-character.

```
DATA EXTENSION
▷OFF
COURSE/SPEE
```

```
DATA EXTENSION
OFF
▷COURSE/SPEE
```

◇ Time stamp

Selects transmitting time stamp type from DHM, HMS and OFF. This function can be transmitted UTC (Universal Time Coordinated)time only.

- **OFF** : No time stamp is transmitted. (default)
- **DHM** : Time stamp in the format of Day, Hour and Minute is transmitted.
- **HMS** : Time stamp in the format of Hour, Minute and Second is transmitted.

```
TIME STAMP
▷OFF
DHM
HMS
```

```
TIME STAMP
OFF
DHM
▷HMS
```

[DIAL] ↔ [A](2)/[V](8) †[←](5) ↔ [→](6)

◇ GPS-A symbol

Selects the desired GPS-A symbol.

Available symbols: Ambulance, Bus, Fire Truck, Bicycle, Yacht, Helicopter, Small Aircraft, Ship (Power Boat), Car (default), Motorcycle, Balloon, Jeep, Recreational Vehicle, Truck, Van and Other.

If “Other” is selected, set the desired symbol code as follows;

- ① Push [**←**](5)[†] to begin programming.
- ② Rotate [DIAL] to select the 1st character from “\” and “/.”
- ③ Push [**▶**](6) to select the 2nd digit.
- ④ Rotate [DIAL] to select the 2nd digit character.
- ⑤ Push [**←**](5)[†] to program the symbol code, then exit programming.
- ⑥ Push [**◀**](4) to return to GPS-A SET MODE screen mode.

/// When “Other” is selected, check the symbol codes of APRS[®] and set it correctly.

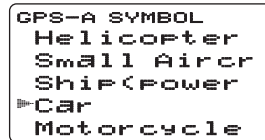
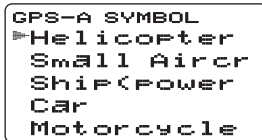

◇ Comment

Program up to a 43-character* comment. The programmed comment is transmitted with the GPS position data.

*36-character comment can only be programmed when “COURSE/SPEED” is selected in data extension.

- ① Push [**←**](5)[†] twice to enter programming.
- ② Rotate [DIAL] to select the desired character.
 - The selected character blinks.
 - Push [**A/a**](3) to change the character group from “AB” (alphabetical characters; capital letters), “ab” (alphabetical characters; lower case letters), “12” (numbers) and “!” (symbols) in sequence.
 - Push [**▶**](6) to move the cursor right; push [**◀**](4) to move the cursor left.
 - Push [**CLR**](1) to erase the selected character, or push and hold [**CLR**](1) for 1 sec. to erase all characters following the cursor.
- ③ Repeat step ② until the desired comment is programmed.
- ④ Push [**←**](5) to program the comment and exit comment programming.
- ⑤ Push [**◀**](4) to return to GPS-A SET MODE screen mode.

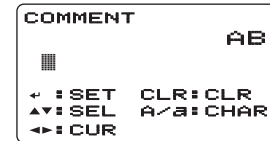

12 MENU SCREEN OPERATION

◇ GPS auto TX timer

Selects the desired interval for automatic position transmission function from OFF (default), 5, 10, 30 second, 1, 3, 5, 10 and 30 minutes.

```
GPS AUTO TX
▼OFF
5SEC
10SEC
30SEC
1MIN
```

```
GPS AUTO TX
OFF
5SEC
10SEC
▼30SEC
1MIN
```

/// **NOTE:** When 4th GPS sentence are selected at "GPS SENTENCE" (pgs. 102, 103), "5SEC" can not be selected.

◇ DV auto detect

When a signal other than DV mode is received during DV mode operation, the transceiver has capability of automatic FM mode selection.

- OFF : Operating mode is fixed in DV. (default)
- ON : The transceiver automatically selects FM mode for temporary operation.

```
DV AUTO DETECT
▼OFF
ON
```

```
DV AUTO DETECT
OFF
▼ON
```

◇ Call sign edit record

Selects call sign programming when the call sign is edited or corrected with the pre-programmed call sign.

- OFF : The edited or corrected call sign is overwritten.
- SELECT : The edited or corrected call sign is programmed into the selected call sign memory.
- AUTO : The edited or corrected call sign is programmed into a blank channel automatically. (default)

```
EDIT RECORD
OFF
SELECT
▼AUTO
```

```
EDIT RECORD
OFF
▼SELECT
AUTO
```

[DIAL] ↔ [A](2)/[V](8) †[←](5) ↔ [→](6)

◇ Break-in function

The break-in function allows you to break into a conversation where the two original stations are communicating with call sign squelch enabled.

- OFF : The break-in function is set to OFF. (default)
- ON : The break-in function is set to ON.
 - “BK” appears on the display.

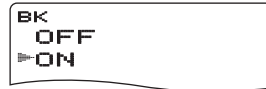
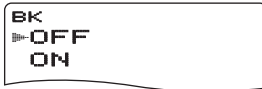

NOTE: The break-in function is turned OFF automatically when turning transceiver's power OFF

◇ EMR function

The EMR communication mode is available for digital mode operation. In the EMR communication mode, no call sign setting is necessary. When an EMR communication mode signal is received, the audio (voice) will be heard at the specified level even the volume setting level is set to minimum level, or digital call sign/digital code squelch is in use.

- OFF : The EMR function is set to OFF. (default)
- ON : The EMR function is set to ON.
 - “EMR” appears on the display.

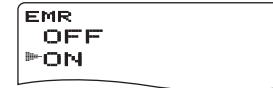
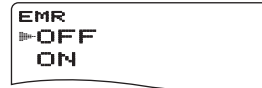

NOTE: The EMR communication function is turned OFF automatically when turning transceiver's power OFF

12 MENU SCREEN OPERATION

■ Scan set mode items

◇ Priority watch

Activates priority watch or priority watch with alert (Bell).

- OFF : The priority watch is turned OFF. (default)
- ON : The transceiver checks the memory channel frequency every 5 sec.
- BELL : The transceiver checks the memory channel frequency every 5 sec. You can be alerted with beeps and blinking “(•)”.

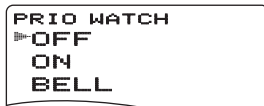

◇ Scan pause timer

Selects the scan pause time. When receiving signals, the scan pauses according to the scan pause time.

- 2–20 SEC : Scan pauses for 2–20 sec. on a received signal in 2 sec. steps. (default: 10 sec.)
- HOLD : Scan pauses on a received signal until it disappears. Rotate [DIAL] to resume manually.

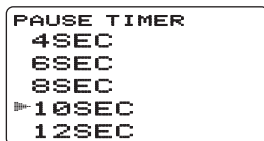

◇ Scan resume timer

Selects the scan resume time from a pause after the received signal disappears.

- 0 SEC : Scan resumes when a received signal disappears.
- 1–5 SEC : Scan pauses 1–5 sec. after a received signal disappears. (default: 2 sec.)
- HOLD : Scan remains paused on the received signal even if it disappears. Rotate [DIAL][†] to resume manually.

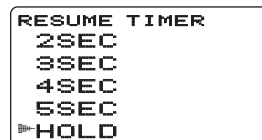
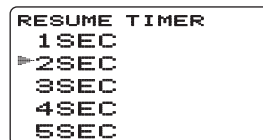

/// Scan resume timer must be set shorter than scan pause timer (previous item), otherwise this timer does not activate.

◇ Memory bank link function

Sets the memory bank link function ON (default) and OFF. The link function provides continuous bank scan, scanning all contents in the selected banks during bank scan.

• Bank link setting

- ① Rotate [DIAL][†] to select the bank that you want to change.

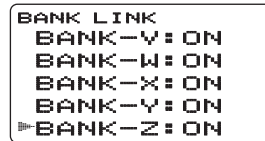
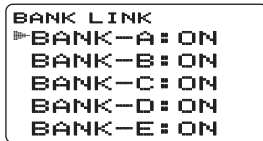

- ② Push [←](5)[‡] to enter bank setting.
- ③ Rotate [DIAL][†] to select the setting.

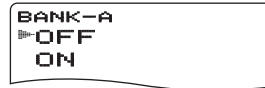
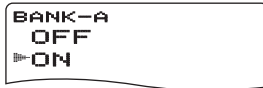

- ④ Push [←](5) to set and return to the BANK LINK screen.
- ⑤ Rotate [DIAL][†] to select next bank and repeat steps ② to ④, or push [MENU/↵] to exit scan set mode.

◇ Program scan link function

Sets the program scan link function ON (default; P-01–P24) and OFF (default; P-00). The link function provides continuous program scan in the selected program scan number during program scan.

• Program scan link setting

- ① Rotate [DIAL][†] to select the program scan number that you want to change.

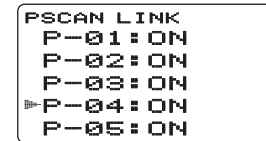
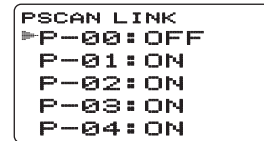

- ② Push [←](5)[‡] to enter program scan setting.
- ③ Rotate [DIAL][†] to select the setting.

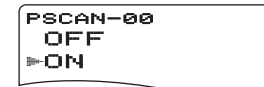
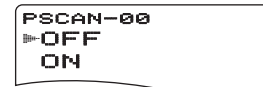

- ④ Push [←](5) to set and return to the PSCAN LINK screen.
- ⑤ Rotate [DIAL][†] to select next program scan and repeat steps ② to ④, or push [MENU/↵] to exit MENU screen operation.

12 MENU SCREEN OPERATION

■ DUP/TONE set mode items

◇ Offset frequency

Sets the offset frequency for duplex (repeater) operation within a 0 to 159.995 MHz range.

OFFSET FREQ
0.000.00

OFFSET FREQ
159.995.00

The default value may differ according to the selected frequency band (before accessing DUP/TONE set mode) and transceiver version.

/// The selected tuning step in VFO mode is used when setting the offset frequency.

◇ Repeater tone frequency

Selects subaudible tone frequency for accessing a repeater, etc. 50 tone frequencies (67.0–254.1 Hz) are available.

(default: 88.5)

REPEATER TONE
88.5

REPEATER TONE
254.1

◇ TSQL frequency

Selects tone frequency for tone squelch or pocket beep operation from one of 50 available frequencies (67.0–254.1 Hz).

(default: 88.5)

CTCSS TONE
88.5

CTCSS TONE
254.1

• Available subaudible tone frequencies

67.0	79.7	94.8	110.9	131.8	156.7	171.3	186.2	203.5	229.1
69.3	82.5	97.4	114.8	136.5	159.8	173.8	189.9	206.5	233.6
71.9	85.4	100.0	118.8	141.3	162.2	177.3	192.8	210.7	241.8
74.4	88.5	103.5	123.0	146.2	165.5	179.9	196.6	218.1	250.3
77.0	91.5	107.2	127.3	151.4	167.9	183.5	199.5	225.7	254.1

/// The transceiver has 50 tone frequencies and consequently their spacing is narrow compared with units having 38 tones. Therefore, some tone frequencies may receive interference from adjacent tone frequencies.

◇ DTCS code

Selects DTCS (both encoder/decoder) code for DTCS squelch operation. Total of 104 codes (023–754) are available.

(default: 023)



• Available DTCS codes

023	054	125	165	245	274	356	445	506	627	732
025	065	131	172	246	306	364	446	516	631	734
026	071	132	174	251	311	365	452	523	632	743
031	072	134	205	252	315	371	454	526	654	754
032	073	143	212	255	325	411	455	532	662	
036	074	145	223	261	331	412	462	546	664	
043	114	152	225	263	332	413	464	565	703	
047	115	155	226	265	343	423	465	606	712	
051	116	156	243	266	346	431	466	612	723	
053	122	162	244	271	351	432	503	624	731	

◇ DTCS polarity

Sets DTCS polarity from “BOTH N” (TX/RX: normal), “TN-RR” (TX: normal, RX: reverse), “TR-RN” (TX: reverse, RX: normal) and “BOTH R” (TX/RX: reverse). (default: BOTH N)

Transmitting or receiving DTCS code’s polarity is sets by this item at transmitting side and receiving side respectively.

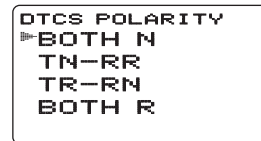

TX/RX: Normal polarity

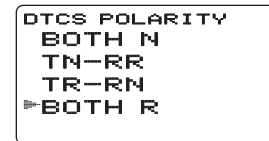

TX/RX: Reverse polarity

◇ DTMF speed

Select the desired DTMF transmission speed from 100 msec, 200 msec, 300 msec, 500 msec.

- 100 : 100-msec. interval; 5.0 characters per second (default)
- 200 : 200-msec. interval; 2.5 characters per second
- 300 : 300-msec. interval; 1.6 characters per second
- 500 : 500-msec. interval; 1.0 character per second

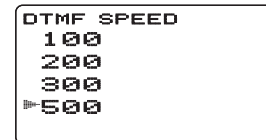
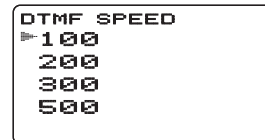

12 MENU SCREEN OPERATION

◇ DTMF TX KEY

Selects DTMF transmitting code when pushing and holding [PTT], then pushing one of the 10-key keypad buttons.

- KEY : [1]–[9], [0], [A], [B], [C], [D], [E](*) or [F](#)
DTMF tones are transmitted when the key is pressed. (default)
- DTMF-M : The DTMF memory contents Ch01–Ch10 and transmitted.

```
DTMF TX KEY
▷KEY
DTMF-M
```

```
DTMF TX KEY
KEY
▷DTMF-M
```

■ Display set mode items

◇ Display backlighting

The transceiver has display backlighting with a 5 sec. timer for night time operation. The display backlighting can be turned ON continuously or turned OFF, if desired.

- OFF : The backlight is turned OFF.
- ON : The backlight continuously lights ON.
- AUTO : Lights when an operation is performed, goes out after 5 sec. (default)

```
BACKLIGHT
OFF
ON
▷AUTO
```

```
BACKLIGHT
▷OFF
ON
AUTO
```

◇ Busy LED

The TX/RX indicator lights green while receiving a signal or when the squelch is open. This indication can be turned OFF to conserve the battery power, if desired.

- OFF : The indicator does not function even if a signal is received.
- ON : The indicator lights green while receiving a signal or when the squelch is open. (default)

```
BUSY LED
OFF
▷ON
```

```
BUSY LED
▷OFF
ON
```

◇ **LCD contrast**

The contrast of the LCD can be selected from 16 levels.

- 1 (Low contrast) to 16 (High contrast) (default: 8)



Default (8)



High contrast (16)

◇ **RX call sign display (B band only)**

When a cal is received, the calling station call sign can be indicated automatically. (default: AUTO)



◇ **TX call sign display (B band only)**

Selects call sign display function from YOUR, MY and OFF. When this setting is set to YOUR or MY, the transceiver automatically indicates the set station or your own call sign during digital mode transmission. (default: YOUR)



◇ **RX message display (B band only)**

Sets auto received message display function AUTO and OFF. When this setting is set to AUTO, the transceiver automatically displays and scrolls the received message. (default: AUTO)



12 MENU SCREEN OPERATION

◇ Scroll speed

Set the displayed message, call sign, etc. scrolling speed.

- **FAST** : Scroll speed is set to fast. (default)
- **SLOW** : Scroll speed is set to slow.

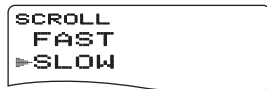
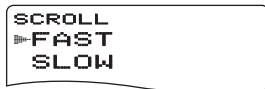

◇ Scan name

The programmed scan or bank name is displayed during the scan type selection.

- **ON** : The programmed scan or bank name is displayed. (default)
- **OFF** : The programmed scan or bank name is not displayed.

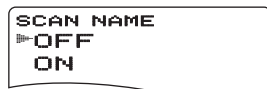
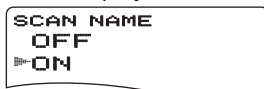

◇ Opening logo

The opening logo indication (Icom logo and transceiver name) that is displayed at power ON can be skipped, if desired.

- **ON** : Opening logo is displayed at power ON. (default)
- **OFF** : Opening logo indication is skipped.



◇ Opening call sign

The set my call sign, can be displayed at power ON.

(default: OFF)



◇ Font size

Displayed character size during MENU mode indication in the function display is selectable from Large and Small.

- **LARGE** : Makes 5 lines (Max. 5 items are displayed at the same time). (default)
- **SMALL** : Makes 6 lines (Max. 6 items are displayed at the same time).



■ Sounds set mode items

◇ Beep output level

Adjusts the key-touch beep tone level to the desired level within 39 levels.

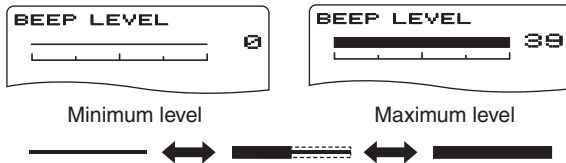

▨ The key-touch beep (following item) must be set to ON to have a beep tone.

◇ Key-touch beep

Turns the key-touch beep ON or OFF. (default: ON)

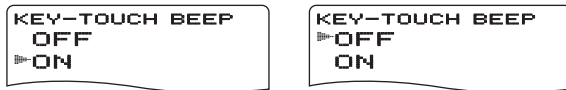

◇ Scan stop beep



Turns the scan stop beep function ON or OFF. (default: OFF)

◇ Scope audio output

Select the audio output function capability during sweep with band scope function.

- ON : The received audio is heard during sweep. (default)
- OFF : No audio is heard during sweep.



◇ Volume select

Select the volume level adjustment from Both and Separate for dualwatch operation.

- BOTH : Both A band and B band volume level is adjusted with [VOL] at the same time. (default)
- SEPARATE : The Volume setting is adjusted independently in A and B bands with [VOL].



12 MENU SCREEN OPERATION

◇ Standby beep (B band only)

Turns the beep emission capability ON and OFF when the communicating station finishes transmitting or the receive



signal disappears while in the digital mode operation. (default: ON)

◇ Sub-band muting function

Sub-band audio signal condition is selectable while dual-band operating.

- OFF : Disable sub-band muting function. (default)
- MUTE : Sub-band audio signal is muted when receiving signal on MAIN band.
- BEEP : Beep sounds when finishing to receive sub-band signal.



■ Programming a DTMF code

DTMF codes are used for autopatching, accessing repeaters, controlling other equipment, etc. The transceiver has 10 DTMF memory channels (Ch01–Ch10) for storage of often-used DTMF codes of up to 16 digits.

- ① Push and hold **[DTMF.M](9)** for 1 sec. to enter DTMF memory.
- ② Rotate **[DIAL]**† to select the desired DTMF memory channel.
 - “T-CALL” appears when a 1750 Hz tone burst signal is selected. (p. 33)



Displays NO indication when the blank channel is selected.

- ③ Push **[>](6)** to enter programming mode.
 - Previously programmed DTMF code is displayed if programmed.

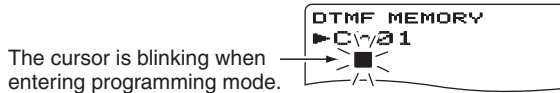

The cursor is blinking when entering programming mode.

- ④ Push the desired keys to input the characters.
 - **[0]–[9]** input “0”–“9,” **[A](VFO)** inputs “A,” **[B](MR)** inputs “B,” **[C](CALL)** inputs “C,” **[D](BAND)** inputs “D,” **[#](.)** inputs “#” and **[*](REC)** inputs “*.”
 - Up to 16 digits can be programmed.
 - Push **[MAIN/DUAL]** to delete the cursor placed code.
 - Push and hold **[MAIN/DUAL]** for 1 sec. to delete the character at the cursor and all following characters.
- ⑤ Repeat step ④ until the desired code is input.

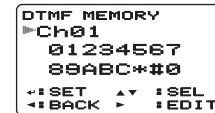
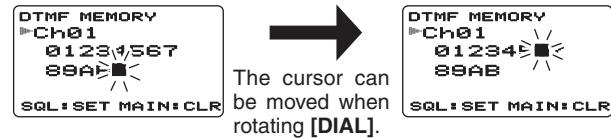

The display after 16th digit of channel 01 is input.

- ⑥ Push **[MENU/TO]** to program the DTMF code and exit programming mode.
 - Entering 16th digit automatically exits the programming mode.
- ⑦ Push **[VFO]** to exit DTMF memory.

†**[DIAL]** ↔ **[A](2)/[V](8)**

13 OTHER FUNCTIONS

■ Transmitting a DTMF code

◇ Transmitting from DTMF memory

The selected DTMF code is transmitted at each push of the [SQL] switch while transmitting.

▨ The transmitting speed at which DTMF memories send individual DTMF characters can be set in “DTMF SPEED” menu. (p. 111)

- ① Set the desired frequency. (p. 18)
- ② Push and hold [DTMF.M](9) for 1 sec. to enter DTMF memory.
- ③ Rotate [DIAL][†] to select the desired DTMF memory channel.
- ④ Push [↵](5) to set the DTMF memory.
- ⑤ Push [VFO] to exit DTMF memory.
- ⑥ While pushing [PTT], push [SQL] to transmit the selected DTMF code.

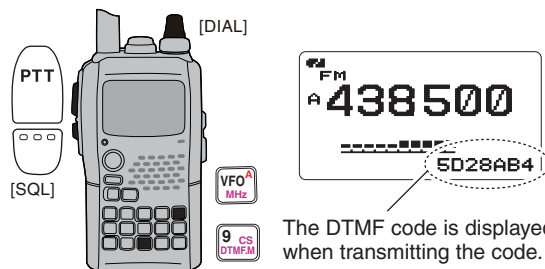

The DTMF code is displayed here when transmitting the code.

◇ Transmitting from DTMF memory in VFO mode

The selected DTMF memory can be transmitted via keypad directly while transmitting. Pushing [1]–[9] or [0] to transmit DTMF memory channel (Ch01–Ch09 or Ch10) respectively.

- ① Set the desired frequency. (p. 18)
- ② Enter “DTMF TX KEY” in DUP/TONE... set mode. (p. 112)

◀[MENU screen] ⇄ ▶[DUP/TONE...] ⇄ ▶[DTMF TX KEY]
(Push [MENU/↵] (Rotate [DIAL][†], then push [↵](5).)

- ③ Rotate [DIAL][†] to select DTMF transmitting key (DTMF-M) as below.

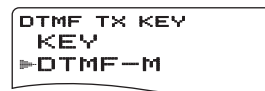

- ④ Push [↵](5) (or [←](4)) to return to DUP/TONE... set mode, and push [MENU/↵] to return to frequency indication.
- ⑤ While pushing [PTT], push the desired keys to transmit the selected DTMF memory.
 - [1]–[9] transmits “Ch01”–“Ch09” and [0] transmits “Ch10.”

◇ Transmitting a DTMF code directly

DTMF code can be transmitted via keypad directly while transmitting.

- ① Set the desired frequency. (p. 18)
- ② Enter "DTMF TX KEY" in DUP/TONE... set mode. (p. 112)

◀MENU screen▶ ↔ ▶DUP/TONE...▶ ↔ ▶DTMF TX KEY▶
(Push [MENU/PTT]) (Rotate [DIAL][†], then push [←](5)[‡].)

- ③ Rotate [DIAL][†] to select DTMF transmitting key (KEY).
- ④ While pushing [PTT], push the desired keys to transmit the DTMF code.
 - [0]–[9] input "0"–"9," [A](VFO) inputs "A," [B](MR) inputs "B," [C](CALL) inputs "C," [D](BAND) inputs "D," [#](.) inputs "#" and [*](REC) inputs "*."

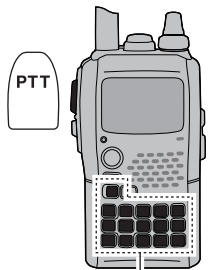

DTMF code keys



DTMF codes do not appear on the display when transmitting codes directly.

■ Clearing a DTMF memory

An unwanted DTMF memory can be cleared (erased).

- ① Push and hold [DTMF.M](9) for 1 sec. to enter DTMF memory mode.
- ② Rotate [DIAL][†] to select the desired DTMF memory channel to be cleared.
- ③ Push and hold [CLR](1) for 1 sec. to clear the selected DTMF memory channel.
- ④ Push [VFO](A) to exit DTMF memory.

• When entering DTMF programming mode.



• After clearing the DTMF memory.



[†][DIAL] ↔ [A](2)/[V](8) [‡][←](5) ↔ [→](6)

13 OTHER FUNCTIONS

■ Confirming a DTMF memory

A DTMF memory can be confirmed with a DTMF tone.

- ① Push and hold **[DTMF.M](9)** for 1 sec. to enter DTMF memory mode.
- ② Rotate **[DIAL]†** to select the desired DTMF memory channel.
- ③ Push **[SQL]** to confirm the DTMF memory contents.
- ④ Push **[VFO](A)** to exit DTMF memory.

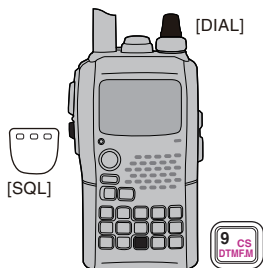

Push **[SQL]**, then sounds DTMF codes.

```
DTMF MEMORY
▶ Ch01
01234567
89ABC*#0
◀ :SET   ▲ :SEL
▶ :BACK ▶ :EDIT
```

■ Setting DTMF transfer speed

The DTMF transfer speed can be selected.

- ① Enter "DTMF SPEED" in DUP/TONE... set mode. (p. 111)

◀MENU screen> ⇄ <DUP/TONE...> ⇄ <DTMF SPEED>
(Push **[MENU/↻]**) (Rotate **[DIAL]†**, then push **[↵](5)†**.)

- ② Rotate **[DIAL]†** to select DTMF transfer speed as below.
100: Transfer the DTMF tones at about 100 msec. per tone.
200: Transfer the DTMF tones at about 200 msec per tone.
300: Transfer the DTMF tones at about 300 msec per tone.
500: Transfer the DTMF tones at about 500 msec per tone.
- ③ Push **[↵](5)** (or **[↶](4)**) to return to DUP/TONE... set mode, and push **[MENU/↻]** to return to frequency indication.

```
DTMF SPEED
▶ 100
  200
  300
  500
```

■ Tone frequency and DTCS code

◇ Subaudible (repeater) tone

Some repeaters require subaudible tones to be accessed. Subaudible tones are superimposed over your normal signal and must be set in advance.

◇ Tone and DTCS squelches

The tone squelch (CTCSS) or DTCS squelch opens only when receiving a signal containing a matching subaudible tone or DTCS code, respectively. You can silently wait for calls from group members using the same tone or code. Separate tone frequencies can be set for repeater and tone squelch/pocket beep operation.

◇ Reverse tone/DTCS squelch

The reverse tone/DTCS squelch is convenient if you want to ignore a specific signal. The transceiver mutes the squelch when a signal with the matched tone or code is received. "TSQL R" / "DTCS R" is displayed when the reverse tone/DTCS is set.

◇ Pocket beep

These functions use subaudible tones or DTCS codes for calling and can be used as a "common pager" to inform you that someone has called while you were away from the transceiver.

◇ Setting subaudible tones for repeater or tone squelch

- ① Enter "CTCSS TONE (or RPT TONE)" in DUP/TONE... set mode. (p. 110)
- ② Rotate [DIAL][†] to select the desired repeater or CTCSS tone frequency.

⟨MENU screen⟩ ⇄ ⟨DUP/TONE...⟩ ⇄ ⟨CTCSS TONE⟩
(Push [MENU/TONE] (Rotate [DIAL][†], then push [←](5)[‡].)

- Each operating band and each memory channel have independent settings.
 - See page 110 for available tone frequencies for details.
- ③ Push [←](5) (or [←](4)) to return to DUP/TONE... set mode, and push [MENU/TONE] to return to frequency indication.

CTCSS TONE
88.5

REPEATER TONE
88.5

[†][DIAL] ⇄ [A](2)/[V](8) [‡][←](5) ⇄ [→](6)

13 OTHER FUNCTIONS

■ Tone frequency and DTCS code (Continued)

◇ Setting DTCS code for DTCS squelch or beep

- ① Enter “DTCS CODE” in DUP/TONE... set mode. (p. 111)

⟨MENU screen⟩ ⇄ ⟨DUP/TONE...⟩ ⇄ ⟨DTCS CODE⟩
(Push [MENU/↻]) (Rotate [DIAL]†, then push [↵](5)†.)

- ② Rotate [DIAL]† to select the desired DTCS tone code.
 - Each operating band and each memory channel have independent settings.
 - See page 111 for available DTCS codes for details.
- ③ Push [↵](5) (or [↶](4)) to return to DUP/TONE... set mode, and push [MENU/↻] to return to frequency indication.

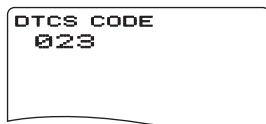

DTCS phase mode can be selected in “DTCS POLARITY” menu. (p. 111)

■ Digital code and digital call sign setting

◇ Setting digital code for digital code squelch or beep

- ① Push [MAIN/DUAL] to select B band, then push and hold [MODE](REC) for 1 sec. several times to select DV mode.
- ② Enter “DIGITAL CODE” in DV SET MODE. (p. 100)

⟨MENU screen⟩ ⇄ ⟨DV SET MODE⟩ ⇄ ⟨DIGITAL CODE⟩
(Push [MENU/↻]) (Rotate [DIAL]†, then push [↵](5)†.)

- ③ Rotate [DIAL]† to select the desired digital code.
 - Each operating band and each memory channel have independent settings.

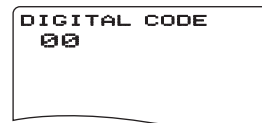

- ④ Push [↵](5) (or [↶](4)) to return to DV SET MODE, and push [MENU/↻] to return to frequency indication.

◇ Setting the YOUR and MY call signs for digital call sign squelch or beep

- ① Push [MAIN/DUAL] to select B band, then push and hold [MODE](REC) for 1 sec. several times to select DV mode.

<MENU screen> ⇄ <CALL SIGN> ⇄ <YOUR CALL SIGN>
 (Push [MENU/TT-O]) (Rotate [DIAL]†, then push [←](5)‡.)

- ② Enter “YOUR CALL SIGN” in CALL SIGN set mode. (p. 34)
- ③ Rotate [DIAL]† to select the desired call sign.
 - Input the call sign if the desired call sign is not stored in the transceiver. See p. 36 for detail.

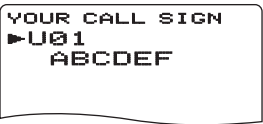

- ④ Push [←](5) to return to CALL SIGN set mode.
 - Push [←](4) to return to CALL SIGN set mode without storing call sign.
- ⑤ Rotate [DIAL]† to select “MY CALL SIGN” in CALL SIGN set mode, then push [←](5)† to enter “MY CALL SIGN” setting.

<MENU screen> ⇄ <CALL SIGN> ⇄ <MY CALL SIGN>
 (Push [MENU/TT-O]) (Rotate [DIAL]†, then push [←](5)‡.)

- ⑥ Rotate [DIAL]† to select the desired call sign.
 - Input the call sign if the desired call sign is not stored in the transceiver. See pgs. 34 and 35 for detail.



- ⑦ Push [←](5) to set call sign and push [MENU/TT-O] to return to frequency indication.

CAUTION!: Use digital code squelch when operating with more than 3 stations. Because the digital call sign squelch function recognizes “MY CALL SIGN,” the digital call sign squelch function can be used when operating with only one station.

NOTE:

- The tone/DTCS code squelch opens sometimes when other stations communicate with adjacent tone frequency or DTCS code.
- No audio sounds with S-meter swaying when receiving signal except my call sign on DV mode .

†[DIAL] ↔ [▲](2)/[▼](8) ‡[←](5) ↔ [▶](6)

■ Tone/DTCS squelch

- ① Set the desired operating frequency, CTCSS tone and DTCS code.
- ② Push and hold **[TONE](7)** for 1 sec. several times to activate the tone or DTCS squelch. (TONE, TSQL or DTCS)
 - Subaudible tone encoder “TONE,” tone squelch “TSQL,” tone squelch reverse “TSQL R,” pocket beep “TSQL (⋅⋅),” DTCS squelch “DTCS,” DTCS squelch reverse “DTCS R,” DTCS beep “DTCS (⋅⋅)” and no tone operation are activated in order.
 - Rotating **[DIAL]** while pushing **[TONE](7)** also selects the tone functions.
- ③ Operate the transceiver in the normal way.
- ④ When the received signal includes a matching tone/code, the squelch opens and the signal can be heard.
 - When the received signal’s tone/code does not match, tone/DTCS squelch does not open, however, the S-indicator shows signal strength.
 - To open the squelch manually, push and hold **[SQL]**.

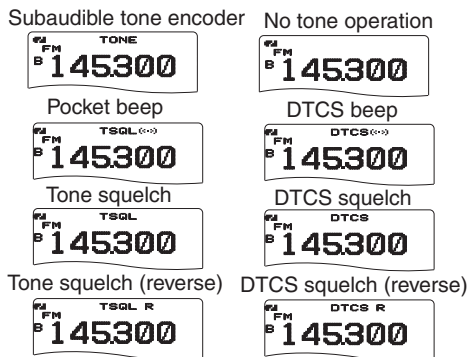

■ Digital code/digital call sign squelch

- ① Set the desired operating frequency on DV mode, Digital code and MY CALL SIGN.
- ② Push and hold **[DSQ](7)** for 1 sec. several times to activate the digital code or digital call sign squelch. (DSQL or CSQL)
 - Digital call sign squelch “DSQL,” Digital call sign beep “DSQL (⋅⋅),” Digital code squelch “CSQL,” Digital code beep “CSQL (⋅⋅)” and no tone operation are activated in order.
 - Rotating **[DIAL]** while pushing **[DSQ](7)** also selects the tone functions.
- ③ Operate the transceiver in the normal way.
- ④ When the received signal includes a matching call sign/code, the squelch opens and the signal can be heard.
 - When the received signal’s call sign/code does not match, digital call sign/digital code squelch does not open, however, the S-indicator shows signal strength.
 - To open the squelch manually, push and hold **[SQL]**.

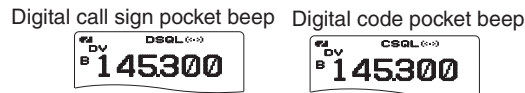

■ Pocket beep function

- ① Set the desired operating frequency.
- ② Set the desired CTCSS tone, DTCS code, Digital call sign or Digital code.
- ③ Push and hold **[TONE](7)/[DSQ](7)** for 1 sec. several times to activate the pocket beep, DTCS beep, Digital call sign beep or Digital code beep. (“TSQL ((•))”, “DTCS ((•))”, “DSQL ((•))” or “CSQL ((•))”)
 - Rotating **[DIAL]** while pushing **[TONE](7)/[DSQ](7)** also selects the tone functions.
- ④ When a signal with the correct tone, code, digital call sign or digital code is received, the transceiver emits beep tones for 30 sec. and blinks “((•)).”

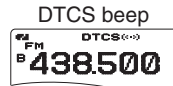
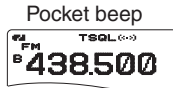

- ⑤ Push **[PTT]** to answer or push **[SQL]** to stop the beeps and blinking.

■ DTCS polarity setting

- ① Enter “DTCS P” in DUP/TONE... set mode. (p. 111)

◀MENU screen▶ ↔ ◀DUP/TONE...▶ ↔ ◀DTCS P▶
 (Push **[MENU/↵]**) (Rotate **[DIAL]**[†], then push **[←](5)**[‡].)

```
DUP/TONE...
RPT TONE
CTCSS TONE
DTCS CODE
▶DTCS P
```

- ② Rotate **[DIAL]**[†] to select the desired DTCS polarity mode.
 - BOTH N : Normal phase is used for both TX and RX. (Default)
 - TN-RR : Normal phase is used for TX; Reverse phase for RX.
 - TR-RN : Reverse phase is used for TX; Normal phase for RX.
 - BOTH R : Reverse phase is used for both TX and RX.
- ③ Push **[←](5)** (or **[←](4)**) to return to DUP/TONE... set mode, and push **[MENU/↵]** to return to frequency indication.

[†][DIAL] ↔ **[▲](2)/[▼](8)**

[‡]**[←](5)** ↔ **[▶](6)**

13 OTHER FUNCTIONS

■ Tone scan

The transceiver can detect the subaudible tone frequency and DTCS code in a received signal. By monitoring a signal that is being transmitted on a repeater input frequency, you can determine the tone frequency required to access the repeater.

- ① Set the desired frequency or memory channel to be checked for a tone frequency or DTCS code.
- ② Push and hold **[TONE](7)** for 1 sec. several times to activate the repeater tone, tone squelch or DTCS squelch. (TONE, TSQL or DTCS)
 - Rotating **[DIAL]** while pushing and holding **[TONE](7)** also selects the tone functions.
- ③ Push and hold **[T.SCAN](.)** for 1 sec. to start the tone scan.
 - To change the scanning direction, rotate **[DIAL]**.
- ④ When the tone frequency or DTCS code is decoded, the set mode contents are programmed with the frequency or code.
 - The tone scan pauses for the set period in scan pause timer (p. 108) when a tone frequency or DTCS code is detected.
 - The decoded tone frequency is used for the repeater tone frequency when the tone squelch is OFF.
 - The decoded tone frequency is used for the tone squelch frequency (CTCSS TONE) when the tone squelch is ON.
 - The decoded DTCS code is used for the DTCS code when the DTCS squelch is ON.

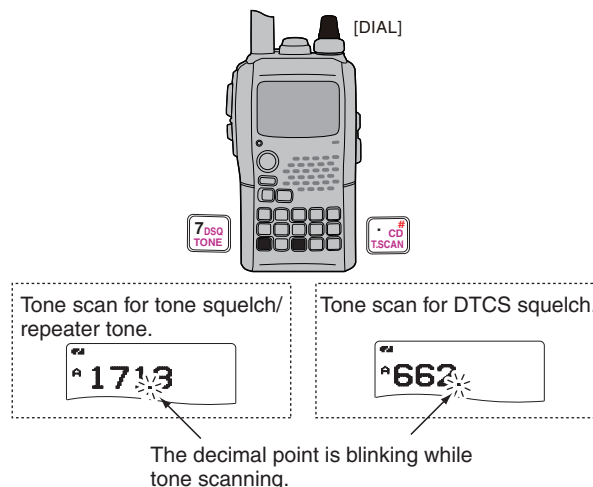

- ⑤ Push **[VFO]** to stop the scan.
 - If the scan is cancelled before the transceiver detects the tone or code, the set mode contents are not changed.
 - The detected tone is used for temporary operation only. The stored tone setting in memory or call channel won't be changed.

NOTE: Tone frequency is over-written automatically when it corresponds with the scanning tone frequency in tone squelch mode. However, it is not over-written in memory or call channel mode.

■ Beep tones

You can select to have confirmation beeps sound at the push of a switch. The output level can be adjusted within 39 levels with “BEEP LEVEL” in sounds set mode. (p. 115)

◀MENU screen ▶ ↔ ◀SOUNDS ▶ ↔ ◀BEEP LEVEL ▶
(Push [MENU/↵]) (Rotate [DIAL]†, then push [←](5)‡.)

You can select silent operation by turning beep tones OFF with “KEY-TOUCH BEEP” in sounds set mode. (p. 115)

◀MENU screen ▶ ↔ ◀SOUNDS ▶ ↔ ◀KEY-TOUCH BEEP ▶
(Push [MENU/↵]) (Rotate [DIAL]†, then push [←](5)‡.)

■ Dial speed acceleration

The dial speed acceleration automatically speeds up the tuning dial speed when rotating [DIAL] rapidly.

This function can be turned ON and OFF with “DIAL SPEED” in menu screen operation. (p. 97)

◀MENU screen ▶ ↔ ◀SET MODE ▶ ↔ ◀DIAL SPEED ▶
(Push [MENU/↵]) (Rotate [DIAL]†, then push [←](5)‡.)

■ Key lock effect

◇ Lock function

The lock function prevents accidental frequency changes and accidental function access.

- Push [MENU/↵] for 1 sec. to toggle the lock function ON and OFF.
 - [PWR], [VOL], [SQL] and [PTT] can still be accessed while the lock function is ON. (default)

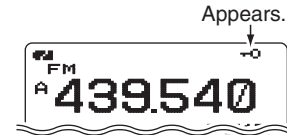

◇ Key lock type

While the lock function is ON, [PWR], [VOL], [SQL] and [PTT] can still be accessed. Accessible switches can be set to one of 4 groups with “LOCK” in set mode. (p. 98)

◀MENU screen ▶ ↔ ◀SET MODE ▶ ↔ ◀LOCK ▶
(Push [MENU/↵]) (Rotate [DIAL]†, then push [←](5)‡.)

- “NORMAL” : [PWR], [VOL], [SQL] and [PTT] are accessible.
- “NO SQL” : [PWR], [SQL] and [PTT] are accessible.
- “NO VOL” : [PWR], [VOL] and [PTT] are accessible.
- “ALL” : [PWR] and [PTT] are accessible.

†[DIAL] ↔ [▲](2)/[▼](8) ‡[←](5) ↔ [→](6)

13 OTHER FUNCTIONS

Weather channel operation

There are 10 weather channels for monitoring weather channels from the NOAA (National Oceanographic and Atmospheric Administration) broadcasts.



Weather channel selection

- 1 Push **[CALL]** several times to select weather channel mode.
 - “WX” and the weather channel number appear.
- 2 Rotate **[DIAL]** to select the desired weather channel.
- 3 Push **[VFO]** or **[MR]** to return to the previous frequency or memory channel.

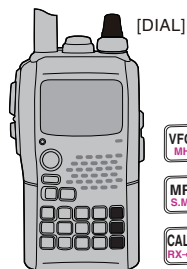

Weather channel indication.

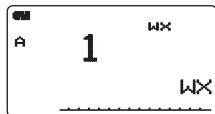

U.S.A. and CANADA versions only

Weather alert function

NOAA broadcast stations transmit weather alert tones before important weather announcements. When the weather alert function is turned ON, the selected weather channel is monitored every 5 sec. for the announcement. When the alert signal is detected, the “ALT” and the WX channel are displayed alternately and sounds a beep tone until the transceiver is operated. The previously selected (used) weather channel is checked periodically during standby or while scanning.

- 1 Select the desired weather channel.
- 2 Enter “WEATHER ALERT” in set mode. (p. 98)

<MENU screen> ⇄ **<SET MODE>** ⇄ **<WEATHER ALERT>**
(Push **[MENU/↺]**) (Rotate **[DIAL]**†, then push **[↵](5)**†.)

- 3 Rotate **[DIAL]**† to select “ON” or “OFF”.
- 4 Push **[↵](5)** (or **[↵](4)**) to return to set mode, and push **[MENU/↺]** to return to the weather channel indication.
- 5 Set the desired stand-by condition.
 - Select VFO, memory or call channel.
 - Scan or priority watch operation can also be selected.

- ⑥ When the alert is detected, a beep sounds and the following indication will be displayed.

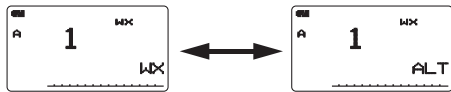

Shows above indications alternately.

- ⑦ Turn the weather alert function OFF in set mode.

NOTE: While receiving a signal (on a frequency other than the weather alert ON frequency), the receiving signal or audio will be interrupted momentarily every 5 sec. (approx.) in the case that the alert function is turned ON. This symptom is caused by the WX alert function. To cancel these symptoms, set the weather alert item OFF in set mode.

Power save

The power save function reduces the current drain to conserve battery power.

The power save duty cycle, the ratio of receive circuit on to receive circuit off during standby, can be set to automatic1 (default), 1 : 4 (150 msec. : 600msec.), 1 : 8 (150 msec. : 1200msec.), automatic2, in addition stopping the operation of a digital block at the DV mode, or OFF with “POWER SAVE” in set mode. (p. 96)

◀MENU screen> ⇄ <SET MODE> ⇄ <POWER SAVE>
(Push [MENU/POWER]) (Rotate [DIAL][†], then push [←](5)[‡].)

- “AUTO1” selects “1:4” duty ratio when receiving no signal for 5 sec., then “1:8” 15 sec. after that.
- “AUTO2” suppresses the consumption of the battery by stopping the operation of a digital block of the DV mode in addition to the operation of Auto1.

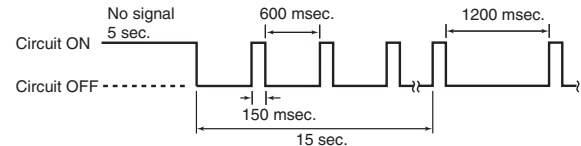

[†][DIAL] ⇄ [▲](2)/[▼](8) [‡][←](5) ⇄ [→](6)

13 OTHER FUNCTIONS

■ Auto power OFF

The transceiver can be set to automatically turn OFF after a specified period with a beep when no switch is pushed.

120 min., 90 min., 60 min., 30 min. and OFF can be specified. The specified period is retained even when the transceiver is turned OFF by the auto power-off function. To cancel the function, select “OFF” in the auto power-off item in set mode.

This can be selected with “AP OFF” in set mode. (p. 96)

⟨MENU screen⟩ ⇄ ⟨SET MODE⟩ ⇄ ⟨AP OFF⟩
(Push [MENU/PTT-O]) (Rotate [DIAL]†, then push [←](5)‡.)

■ Auto power ON

The transceiver can be set to automatically turn ON after a specified period. The timer can be selected within 30 min. to 24 hrs. in 30 min. steps.

This can be selected with “AP ON” in set mode. (p. 98)

⟨MENU screen⟩ ⇄ ⟨SET MODE⟩ ⇄ ⟨AP ON⟩
(Push [MENU/PTT-O]) (Rotate [DIAL]†, then push [←](5)‡.)

/// When operating with battery pack or case and the battery is exhausted, auto power-on does not function.
/// During standby, a small current still flows in the radio.

■ Time-out timer

To prevent accidental prolonged transmission, etc., the transceiver has a time-out timer. This timer cuts a transmission OFF after 1, 3, 5 or 10 min. of continuous transmission. This timer can be cancelled (default).

/// Approx. 10 sec. before the time-out timer is activated, the transceiver emits a beep tone as a warning.

This can be selected with “TOT” in set mode. (p. 99)

⟨MENU screen⟩ ⇄ ⟨SET MODE⟩ ⇄ ⟨TOT⟩
(Push [MENU/PTT-O]) (Rotate [DIAL]†, then push [←](5)‡.)

■ PTT lock

To prevent accidental transmission, etc., the transceiver has a PTT lock function.

This can be selected with “PTT LOCK” in set mode. (p. 99)

⟨MENU screen⟩ ⇄ ⟨SET MODE⟩ ⇄ ⟨PTT LOCK⟩
(Push [MENU/PTT-O]) (Rotate [DIAL]†, then push [←](5)‡.)

■ Font size

Displayed character size during MENU mode indication in the function display is selectable from Large and Small.

⟨MENU screen⟩ ⇄ ⟨DISPLAY⟩ ⇄ ⟨FONT SIZE⟩
 (Push [MENU/⏏]) (Rotate [DIAL]†, then push [←](5)‡.)

NOTE: The set font size is available in menu, DTMF memory and select memory write screens only.

■ Display backlighting

The transceiver has display backlighting with a 5 sec. timer for night time operation. The display backlighting can be turned ON continuously, turned AUTO or turned OFF, if desired.

⟨MENU screen⟩ ⇄ ⟨DISPLAY⟩ ⇄ ⟨BACKLIGHT⟩
 (Push [MENU/⏏]) (Rotate [DIAL]†, then push [←](5)‡.)

■ LCD contrast

The contrast of the LCD can be selected from 16 levels.

⟨MENU screen⟩ ⇄ ⟨DISPLAY⟩ ⇄ ⟨LCD CONT⟩
 (Push [MENU/⏏]) (Rotate [DIAL]†, then push [←](5)‡.)

13 OTHER FUNCTIONS

■ Cloning function

The IC-92AD has transceiver-to-transceiver data cloning capability. This function is useful when you want to copy all of the programmed contents from one IC-92AD to another.

- An optional OPC-474 CLONING CABLE and OPC-1797 CONNECTION CABLE are required.

- ① Turn the transceiver's power OFF, then connect an optional OPC-474 and OPC-1797 between both **[SP]** jacks.
- ② While holding **[MR]** and **[MENU/↵]**, push and hold **[PWR]** for 1 sec. to enter cloning mode.
 - "CLONE M" appears.
- ③ Push **[PTT]** on the "master" transceiver.
 - "CLONE OUT M" appears and the bar meter shows that cloning is taking place.
 - After the cloning is completed, the display returns to "CLONE END."
- ④ Push and hold **[PWR]** for 1 sec. to turn power OFF.

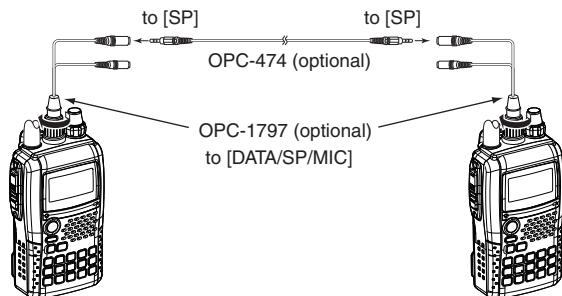

The optional RS-92 REMOTE CONTROL SOFTWARE is also available to clone/edit contents with a PC (for Microsoft® Windows® 98/98SE/ME/2000/XP/Vista) and using ICF format files.

■ Resetting

The display may occasionally display erroneous information (e.g. when first applying power). This may be caused externally by static electricity or by other factors.

If this problem occurs, turn power OFF. After waiting a few seconds, turn power ON again. If the problem persists, perform either or both procedures below.

• All reset

Reset the CPU before operating the transceiver for the first time, or if the internal CPU malfunctions, to clear and return all programmed contents to their default settings.

• Partial reset

If you want to initialize the operating conditions (VFO frequency, VFO settings, set mode contents) without clearing the memory contents, a partial reset function is available for the transceiver.

◇ All reset

- ① Push and hold **[PWR]** for 1 sec. to turn power OFF.
- ② While pushing and holding **[VFO]**, **[MR]** and **[BAND]**, then turn power ON to reset the CPU.
 - “ALL RESET” appears when resetting the CPU (See the illustration below).

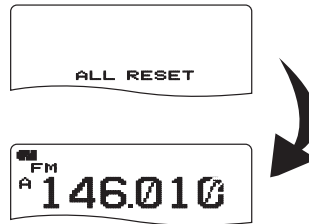

CAUTION: Resetting the CPU returns all programmed contents to their default settings.

◇ Partial reset

- ① Push and hold **[PWR]** for 1 sec. to turn power OFF.
- ② While pushing and holding **[VFO]**, then turn power ON to partially reset the transceiver.

[NOTE]: No message appears on the display after the partial reset is done.



14 TROUBLESHOOTING

If your transceiver seems to be malfunctioning, please check the following points before sending it to a service center.

PROBLEM	POSSIBLE CAUSE	SOLUTION	REF.
No power comes ON.	<ul style="list-style-type: none"> • The batteries are exhausted. • Loose connection of a battery pack (case). • The battery polarity is reversed. 	<ul style="list-style-type: none"> • Replace the batteries or charge the battery pack. • Clean battery terminals. • Check the battery polarity. 	pgs. 1, 10–12 p. 12 –
No sound comes from the speaker.	<ul style="list-style-type: none"> • Volume level is too low. • External speaker is connected with OPC-1797. 	<ul style="list-style-type: none"> • Rotate [VOL] to suitable level. • Check the connection of the external speaker or OPC-1797 correctly. 	p. 20 –
Transmitting is impossible.	<ul style="list-style-type: none"> • The batteries are exhausted. • A frequency outside of the 144/440 MHz amateur bands is set. 	<ul style="list-style-type: none"> • Replace the batteries or charge the battery pack. • Reset the frequency within 144/440 MHz amateur bands. 	pgs. 1, 10–12 p. 24
No contact possible with another station.	<ul style="list-style-type: none"> • Different tone is selected with tone/DTCS squelch. 	<ul style="list-style-type: none"> • Check the tone/DTCS using tone scan. 	p. 126
Frequency can not be set.	<ul style="list-style-type: none"> • The lock function is activated. • Memory mode or call channel is selected. 	<ul style="list-style-type: none"> • Push [MENU/⇐○] for 1 sec. to cancel the function. • Push [VFO] to set VFO mode. 	p. 25 p. 15
Program scan function can not start.	<ul style="list-style-type: none"> • Memory mode or call channel is selected. • Same frequencies are programmed both “*A” and “*B” of PROGRAM-CH. 	<ul style="list-style-type: none"> • Push [VFO] to set VFO mode. • Programming different frequencies in “*A” and “*B” respectively. 	p. 15 p. 84
Memory scan function can not start.	<ul style="list-style-type: none"> • VFO mode or call channel is selected. • The programmed memory channel is only one. 	<ul style="list-style-type: none"> • Push [MR] to set memory mode. • Program more than 2 memory channels. 	p. 15 pgs. 74, 85
The displayed frequency is erroneous.	<ul style="list-style-type: none"> • The CPU malfunctioned. • External factors caused a fault. 	<ul style="list-style-type: none"> • Reset the transceiver. • Remove and re-attach the battery pack or battery case. 	p. 133 p. 1
Can not charge the battery with BC-177 (LED blinks orange).	<ul style="list-style-type: none"> • The transceiver's power is ON. • The battery pack is fault electric discharge. 	<ul style="list-style-type: none"> • Turn the transceiver's power OFF, or insert only the battery pack into the BC-177 to charge it. • The battery pack is charged alone (without the transceiver) or regular charge is carried out. 	pgs. 9, 11

◇ General

• Frequency coverage : (unit: MHz)

Version	A band	B band
U.S.A.	Tx: 144–148, 420–450*1 Rx: 0.495–823.990*1, *2, 849–868.990, 894–999.990	Tx: 144–148, 420–450*1 Rx: 118–174*2, 350–470*1
CAN	Tx: 144–148, 420–450*1 Rx: 0.495–999.990*1, *2	Tx: 144–148, 420–450*1 Rx: 118–174*2, 350–470*1
S.E.A. CHN EXP	Tx: 137–174*2, 400–470*3 Rx: 0.495–999.990*2, *3	Tx: 137–174*2, 400–470*3 Rx: 118–174*2, 350–470*3

*1Guaranteed 440–450 MHz only, *2Guaranteed 144–148 MHz only,
*3Guaranteed 430–440 MHz only

- Mode : FM, FN-N, AM (Rx only), WFM (Rx only), DV
- No. of memory channels : 1304
(incl. 100 scan edges and 4 call channels)
- Usable temp. range : –20°C to +60°C; –4°F to +140°F
- Tuning steps : 5‡, 6.25‡, 8.33‡, 9‡, 10, 12.5, 15, 20,
25, 30, 50, 100, 125 and 200 kHz
- Frequency stability : ±2.5 ppm
(–20°C to +60°C; –4°F to +140°F)
- Power supply : 10.0–16.0 V DC for external DC power,
or specified Icom's battery pack
- Digital transmission speed: 4.8 kbps
- Voice coding speed : 2.4 kbps
- Current drain (at 7.4 V DC) :
Tx High 144 MHz 1.8 A typical
430/440 MHz 2.1 A typical
Tx Mid. 144 MHz 1.2 A typical
430/440 MHz 1.5 A typical

‡Selectable depending on the operating frequency band.

- Tx Low 144 MHz 0.6 A typical
430/440 MHz 0.7 A typical
- Tx S-Low 0.4 A typical
- Rx Rated output 150 mA typical (single watch; FM)
(at 7.4V DC) 180 mA typical (dualwatch; FM/FM)
200 mA typical (single watch; DV)
220 mA typical (dualwatch; FM/DV)
- Power save 38 mA typical (single watch; FM)
(Duty 1:4) 43 mA typical (dualwatch; FM/FM)
47 mA typical (single watch; DV)
50 mA typical (dualwatch; FM/DV)
- standby 65 mA typical (single watch; FM)
90 mA typical (dualwatch; FM/FM)
110 mA typical (single watch; DV)
130 mA typical (dualwatch; FM/DV)

- Antenna connector : SMA (50 Ω)
- Dimensions : 59(W)×112(H)×34.2(D) mm;
(projections not included)
2⁵/₁₆(W)×4¹³/₃₂(H)×1¹¹/₃₂(D) in
- Weight (approx.) : 325 g; 11.5 oz (with antenna and BP-256)

◇ Transmitter

- Modulation system :
FM Variable reactance freq. modulation
DV (Digital) GMSK reactance freq. modulation
- Output power (at 7.4 V DC)
(Typical) : High 5.0 W, Mid. 2.5 W, Low 0.5 W,
S-Low 0.1 W
- Max. frequency deviation : ±5.0 kHz (FM wide: approx.)
±2.5 kHz (FM narrow: approx.)
- Spurious emissions : Less than –60 dBc at High/Mid.
Less than –13 dBm at Low/Slow
- Ext. mic. impedance : 2 kΩ

15 SPECIFICATIONS

◇ Receiver

- Receive system :
 - Except WFM Double-conversion superheterodyne
 - WFM Triple-conversion superheterodyne
- Intermediate frequencies :
 - 1st A band 61.65 MHz/59.25 MHz (WFM only)
 - B band 46.35 MHz
 - 2nd 450 kHz/13.35 MHz (WFM only)
 - 3rd 1.95 MHz (WFM only)
- Sensitivity (except spurious points):
 - AM (1 kHz/30% Mod.; 10 dB S/N)
 - 0.495–4.995 MHz 1.3 μ V typ.
 - 5.000–29.995 MHz 0.56 μ V typ.
 - 118.000–137.000 MHz 0.5 μ V typ.
 - 222.000–246.995 MHz 0.79 μ V typ.
 - 247.000–329.995 MHz 1 μ V typ.
 - FM (1 kHz/3.5 kHz Dev.; 12 dB SINAD)
 - VHF (Amateur band only) 0.14 μ V typ.
 - UHF (Amateur band only) 0.16 μ V typ.
 - 1.625–29.995 MHz 0.4 μ V typ.
 - 30.000–117.995 MHz 0.25 μ V typ.
 - 118.000–173.995 MHz 0.14 μ V typ.
 - 174.000–259.995 MHz 0.32 μ V typ.
 - 260.000–349.995 MHz 0.32 μ V typ.
 - 350.000–469.995 MHz 0.16 μ V typ.
 - 470.000–599.995 MHz 0.32 μ V typ.
 - 600.000–999.990 MHz 0.56 μ V typ.
 - WFM (1 kHz/52.5 kHz Dev.; 12 dB SINAD)
 - 76.000–108.000 MHz 1 μ V typ.
 - 175.000–221.995 MHz 1.8 μ V typ.
 - 470.000–770.000 MHz 2.5 μ V typ.
 - DV (digital/PN9 4.8 kbps; BER 1%)
 - VHF (Amateur band only) 0.22 μ V typ.
 - UHF (Amateur band only) 0.22 μ V typ.

- Audio output power : More than 200 mW at 10% distortion with an 8 Ω load (at 7.4 V DC)
- Selectivity :
 - FM (Wide), AM More than 50 dB
 - FM (Narrow), DV More than 45 dB
 - WFM More than 300 kHz/–3 dB
 - Less than 700 kHz/–20 dB
- Ext. speaker connector : 3-conductor 3.5(d) mm; ($\frac{1}{8}$ "/8 Ω)
- Spurious and image rejection ratio :
 - VHF More than 60 dB
 - UHF More than 50 dB
 - (Intermediate freq.; More than 60 dB)
- Squelch Sensitivity (except spurious points):
 - AM (1 kHz/30% Mod.)
 - 0.495–4.995 MHz 1.3 μ V typ.
 - 5.000–29.995 MHz 0.56 μ V typ.
 - 118.000–137.000 MHz 0.5 μ V typ.
 - 222.000–246.995 MHz 0.79 μ V typ.
 - 247.000–329.995 MHz 1 μ V typ.
 - FM (1 kHz/3.5 kHz Dev.)
 - 1.625–29.995 MHz 0.4 μ V typ.
 - 30.000–75.995 MHz 0.25 μ V typ.
 - 76.000–117.995 MHz 0.25 μ V typ.
 - 118.000–173.995 MHz 0.14 μ V typ.
 - 174.000–259.995 MHz 0.32 μ V typ.
 - 260.000–349.995 MHz 0.32 μ V typ.
 - 350.000–469.995 MHz 0.16 μ V typ.
 - 470.000–599.995 MHz 0.32 μ V typ.
 - 600.000–999.990 MHz 0.56 μ V typ.
 - WFM (1 kHz/52.5 kHz Dev.)
 - 76.000–108.000 MHz 1 μ V typ.
 - 175.000–221.995 MHz 1.8 μ V typ.
 - 470.000–770.000 MHz 2.5 μ V typ.

◇ Battery pack and charger

- **BP-257** BATTERY CASE
Battery case for LR6 (AA) × 2 alkaline batteries.
- **BP-256** LI-ION BATTERY PACK
7.4 V/1620 mAh Lithium Ion battery pack. Battery life: 6 hrs. (approx.; VHF, FM, high power, Tx : Rx : Standby = 1:1:8)
- **BC-167A/D** BATTERY CHARGER
For regular charging of battery packs. Charging time : Max. 6 hrs.
- **BC-177** DESKTOP CHARGER+**BC-123A** AC ADAPTER
Rapidly charges BP-256 LI-ION BATTERY PACK in approx. 2.5 hrs.

◇ Microphones

- **HM-75A*** REMOTE CONTROL SPEAKER MICROPHONE
Allows you to remotely select operating channels, etc.
- **HM-131*** SPEAKER-MICROPHONE
For operation while conveniently hanging the transceiver from your belt, etc.
- **HM-153/HM-166*** EARPHONE-MICROPHONE
Ideal for hands-free operation by clipping the microphone with the PTT switch to your lapel or breast pocket.
- **HM-174** WATERPROOF SPEAKER-MICROPHONE
Allows you to operate in rainy condition.
- **HM-175GPS** GPS WATERPROOF SPEAKER-MICROPHONE
Allows you to operate in rainy condition and GPS antenna is included.
- **SP-13*** EARPHONE
Provides clear receive audio in noisy environments.
- **HS-85*** HEADSET WITH VOX/PTT UNIT
Hands-free headset with VOX control box.

◇ Other options

- **RS-92** REMOTE CONTROL SOFTWARE
Allows you to operate the transceiver, as well as the easy memory management from the connected PC for Microsoft® Windows® 98/98SE/ME/2000/XP/Vista with an RS-232C (COM) port. In addition, low-speed data communication is enabled with this software for DV mode operation. A data communication cable, OPC-1799, is supplied with the software.
- **CP-12L** CIGARETTE LIGHTER CABLE WITH NOISE FILTER
- **CP-19R** CIGARETTE LIGHTER CABLE WITH DC-DC CONVERTER
Allows you to operate the transceiver through a 12 V cigarette lighter socket, and also charge the attached battery pack (during stand-by only) regularly.
CP-19R: A built-in DC-DC converter outputs 11 V DC.
- **OPC-254L** DC POWER CABLE
For operation and charging via an external power supply.
- **OPC-474*** CLONING CABLE
Used for handheld-to-handheld cloning.
- **OPC-1799*** DATA COMMUNICATION CABLE
Allows you to GPS operation in DV mode operation.
- **OPC-1797** CONNECTION CABLE
For connecting with microphone, earphone, etc.
- **LC-168** CARRYING CASE
Helps protect the transceiver from scratches, etc.
- **AD-92SMA** ANTENNA CONNECTOR ADAPTER
Allows you to connect an external antenna with a BNC connector.

* Requires OPC-1797 for connection to the transceiver.

16 OPTIONS

■ Optional HM-75A REMOTE CONTROL SPEAKER MICROPHONE

The optional HM-75A allows you to remotely select operating frequencies, memory channels, etc. When using this microphone, OPC-1797 is required.

Remote control functions can be selected from 3 settings. These can be selected with "MIC SIMPLE MODE" in set mode. (p. 98)

◀MENU screen▶ ↔ ▶SET MODE▶ ↔ ▶MIC SIMPLE MODE▶
(Push [MENU/LOCK]) (Rotate [DIAL]†, then push [↔](5)‡.)

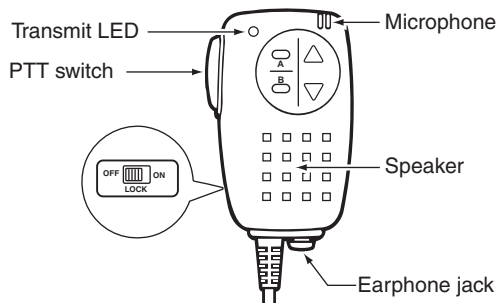

The HM-75A has a lock switch on the backside to prevent accidental frequency changes, etc.

⚡ Be sure to turn power OFF when plugging the HM-75A/unplugging OPC-1797 to/from the [DATA/SP/MIC] jack.

†[DIAL] ↔ [▲](2)/[▼](8) ‡[←](5) ↔ [→](6)

• NORM-1: (default)

[A]	Selects band.
[B]	Toggles VFO mode and memory mode.
[▲]	Frequency or memory channel "UP".
[▼]	Frequency or memory channel "DOWN".

• NORM-2:

[A]	Toggles the monitor function.
[B]	Toggles VFO mode and memory mode.
[▲]	Frequency or memory channel "UP".
[▼]	Frequency or memory channel "DOWN".

• SIMPLE:

[A]	Toggles the monitor function.
[B]	Selects call channel C0.
[▲]	Selects memory channel 000 in memory mode.
[▼]	Selects memory channel 001 in memory mode.

• COMMON (NORM-1/NORM-2/SIMPLE):

[A]	Transmits T-CALL (1750 Hz tone) while pushing [PTT].
[▲]	Volume "UP" while operating the monitor function.
[▼]	Volume "DOWN" while operating the monitor function.

⚡ VFO mode cannot be selected via the microphone when SIMPLE mode is selected.

⚡ SIMPLE mode can select only 3 channels and is useful for group operations during touring, etc.

■ Connecting to the [DATA/SP/MIC] jack

When connecting the optional HM-174 WATERPROOF SPEAKER-MICROPHONE, HM-175GPS GPS WATERPROOF SPEAKER-MICROPHONE or OPC-1799 DATA COMMUNICATION CABLE, OPC-1797 CONNECTION CABLE to the [DATA/SP/MIC] jack, follow the procedure below.

• Connecting to the [DATA/SP/MIC] jack

- ① Remove the rubber cap. from the [DATA/SP/MIC] jack.

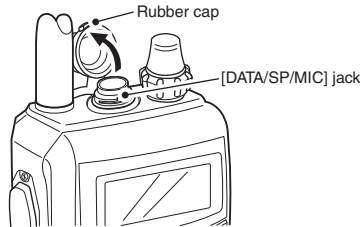

- ② Orient the connector's flat face and the [DATA/SP/MIC] jack's flat face in same direction, (Verifying triangular mark) then insert it tightly.
- ③ Rotate the threaded connector shell clockwise to tighten the connector.

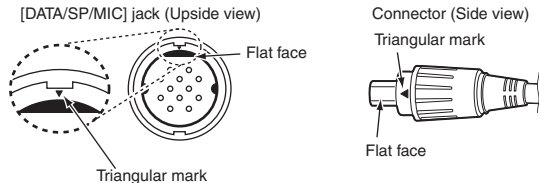

CAUTION!:
Turn power OFF the transceiver before connecting/disconnecting cable to/from the [DATA/SP/MIC] jack.

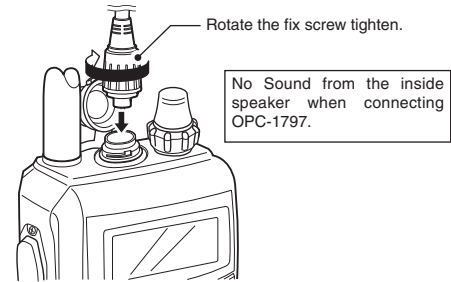

• Disconnecting from the [DATA/SP/MIC] jack

- ① Rotate the threaded connector shell counter-clockwise to loosen the connector.
- ② Disconnect the cable from the [DATA/SP/MIC] jack.
- ③ Reattach the rubber cap tightly to the [DATA/SP/MIC] jack.

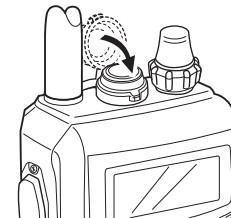

INDEX

– 1 –

1750 Hz tone 33

– A –

About the D-STAR system 40
About priority beep function 90
Accessory attachment 1
Active band 99
Alarm area 1 69
Alarm area 2 69
All reset 133
Antenna 1
Attenuator 96
Attenuator function 22
Auto power OFF 96, 130
Auto power ON 98, 130
Auto repeater 97
Auto repeater function 32
Auto reply 100
Automatic reply function 54
Automatic reply function setting 54
Automatic TV channel programming 28

– B –

Band scope 23
Basic operation 20
Battery charging 8
Battery indicator 10, 12
Battery information 12

Battery information 12
Battery life 12
Battery pack 1, 137
Battery replacement 12
Beep output level 115
Beep tones 127
Belt clip 1
Break-in communication 51
Break-in function 107
Busy LED 112
Busy lockout 99

– C –

Call channel 16
Call sign edit record 106
Call sign programming 34
Caution 8
Channel setting 14
Charger 137
Charging caution 9
Charging note 10, 11
Checking the repeater input signal 30
Clearing a DTMF memory 119
Cloning function 132
Comment 105
Compass direction 68
Confirming a DTMF memory 120
Connecting to the [DATA/SP/MIC] jack 139
Connection 56

Continuous sweep 23
 Copying memory/call contents 79
 Copying Memory/call to memory/call 79
 Copying Memory/call to VFO 79
 Copying the call record contents into call sign memory 50
 Copying the call sign 48
 Copying the call sign memory contents 48

– D –

DATA extension 104
 Desired call record indication 46
 Dial replace 99
 Dial speed acceleration 97, 127
 Digital call sign squelch 124
 Digital code 100
 Digital code and digital call sign setting 122
 Digital code squelch 124
 Digital mode operation 34
 Digital monitor 101
 Digital repeater operation 41
 Digital repeater setting 101
 Digital voice mode operation 38
 Display backlighting 112, 131
 DISPLAY set mode 95
 Display set mode items 112
 Displaying own/received position data with compass 64
 DTCS code 111
 DTCS polarity 111
 DTCS polarity setting 125

DTCS squelch 124
 DTMF speed 111
 DTMF TX KEY 112
 Dualwatch operation 25
 DUP/TONE set mode 95
 DUP/TONE set mode items 110
 Duplex operation 29, 31
 DV auto detect 59, 106
 DV data TX 100
 DV mode operation 34
 DV set mode 95
 DV set mode items 100
 DV voice memory 58

– E –

EMR (Emergency) communication 56
 EMR function 107
 Entering GPS set mode 68
 Entering MENU screen and operation 93
 Erasing/transferring bank contents 81
 Explicit definitions i
 External DC power operation 13

– F –

Features i
 Font size 114, 131
 Foreword i
 Format 68
 Frequency range and offset direction 32

INDEX

Frequency setting	14
Front, top and side panels	2
Full/band/programmed scan	83
Function display	6

– G –

General	93, 135
General description	71
GPS alarm setting	66
GPS auto TX timer	106
GPS data addition	65
GPS memory clearing	67
GPS message automatic transmission	62
GPS message programming	61
GPS operation	60
GPS set mode items	68
GPS speed	68
GPS TX mode	102
GPS-A code details	70
GPS-A function	70
GPS-A operation	60, 70
GPS-A Set mode	103
GPS-A symbol	105

– H –

Hand strap	1
How to change the main band	14

– I –

Important	i
Items list	94

– K –

Key lock effect	127
Key lock type	98, 127
Keypad	4
Key-touch beep	115

– L –

LCD contrast	113, 131
Lock function	25, 127
Low-speed data communication	56
Low-speed data communication application setting	57
Low-speed data communication operation	57

– M –

Main band selection	14, 26
Memory bank link function	109
Memory bank scan	86
Memory bank selection	76
Memory bank setting	75
Memory channel contents	71
Memory channel programming	74
Memory clearing	80
Memory mode	15
Memory scan	85
Memory/call channel and memory scan watch	91

Menu list 94
 MENU screen indication for A band 94
 MENU screen indication for B band 94
 Menu screen operation 93
 Message operation 52
 Message transmission 53
 Microphone simple mode 98
 Microphones 137
 Mode selection 15
 Monitor function 22
 Monitor key action 97

– N –

Notice iv

– O –

Off band indication 30
 Offset frequency 110
 One-touch reply using the call record 47
 Opening call sign 114
 Opening logo 114
 Operating band selection 16
 Operating mode selection 20
 Operating note 13
 Optional battery case 12
 Optional HM-75A REMOTE CONTROL MICROPHONE 138
 Optional UT-121 installation 137
 Options 137
 Other functions 117

Other functions for DV mode operation 58
 Other options 137

– P –

Panel description 2
 Partial reset 133
 Play-back or erase the voice memory 55
 Pocket beep 121
 Pocket beep function 125
 Position indication 63
 Power save 96, 129
 Precautions ii
 Priority watch 90, 108
 Priority watch operation 91
 Priority watch types 90
 Program scan link function 109
 Programming a DTMF code 117
 Programming memory/bank/scan name 77
 PTT lock 99, 130

– R –

Rapid charging 11
 Received call sign 46
 Received GPS message indication 62
 Receiver 136
 Receiving 20
 Regular charging 10
 Repeater call sign auto write 101
 Repeater call sign programming 41

INDEX

Repeater operation	29
Repeater operation in the same zone	42
Repeater operation into another zone	44
Repeater tone frequency	110
Resetting	133
RX call sign auto write	101
RX call sign display	113
RX message display	113
RX message indication	54

– S –

Saving own/received position data	63
Scan edges programming	84
Scan name	114
Scan operation	82
Scan pause timer	89, 108
Scan resume condition	89
Scan resume timer	89, 108
Scan set mode	95
Scan set mode items	108
Scan stop beep	115
Scan types	82
Scope audio output	115
Scroll speed	114
Selecting a call channel	73
Selecting a memory channel	72
Selecting memory/bank name indication	78
Sentence formatter setting	60
Set mode	94
Set mode items	96
Setting a frequency	18
Setting a tuning step	18
Setting audio volume	20, 26
Setting digital code for digital code squelch or beep	122
Setting DTCS code for DTCS squelch or beep	122
Setting DTMF transfer speed	120
Setting duplex direction	31
Setting offset frequency	31
Setting squelch level	20, 27
Setting subaudible tones for repeater or tone squelch	121
Setting the YOUR and MY call signs for digital call sign squelch or beep	123
Single sweep	23
Skip channel setting	28
Skip channel/frequency setting	87
Sounds set mode	95
Sounds set mode items	115
Specifications	135
Standby beep	116
Station call sign programming	36
Subaudible (repeater) tone	121
Sub-band muting function	116
Supplied accessories	iii

– T –

Table of contents	v
Time stamp	104
Time-out timer	99, 130

Tone and DTCS squelches 121

Tone frequency and DTCS code 121

Tone scan 126

Tone squelch 124

Transmission condition setting 57

Transmit power selection 24

Transmitter 135

Transmitting 24

Transmitting a DTMF code 118

Transmitting a DTMF code directly 119

Transmitting from DTMF memory 118

Transmitting from DTMF memory in VFO mode 118

Troubleshooting 134

TSQL frequency 110

Tuning step selection 18

TV channel 16

TV channel operation 28

TV channel receiving 28

TX call sign display 113

TX message programming 52

- U -

Units 68

Unproto Address 103

Using [DIAL]-All channels 72

Using [DIAL]-Programmed channels 72

Using the dial 18

Using the keypad 19, 73

UTC offset 68

- V -

VFO mode 15

VFO scan watch 92

Voice memory recording for automatic reply 55

Volume select 115

Volume setting for dualwatch 27

- W -

Weather alert function 98, 128

Weather channel 16

Weather channel operation 128

Weather channel selection 128

When calling the desired station 39

When sending a CQ 39

- Y -

Your own call sign programming 34

MEMO

Count on us!

A-6616H-1EX
Printed in Japan
© 2007 Icom Inc.

Printed on recycled paper with soy ink.

Icom Inc.

1-1-32 Kamiminami, Hirano-ku, Osaka 547-0003, Japan