



ADVANCED MANUAL

DUAL BAND TRANSCEIVER

ID-4100A ID-4100E

This manual describes instructions for advanced features and instructions.

See the Basic manual and the D-STAR guide that come with the transceiver for precautions, installations, and basic operations.

INTRODUCTION

1 MEMORY OPERATION

2 SCAN OPERATION

3 PRIORITY WATCH

4 D-STAR OPERATION

5 GPS OPERATION

6 USING A microSD CARD

7 VOICE MEMORY

8 REPEATER AND DUPLEX OPERATIONS

9 MENU SCREEN

10 OTHER FUNCTIONS

11 OPTIONS

12 Bluetooth® OPERATION

13 UPDATING THE FIRMWARE

INDEX

INTRODUCTION

Thank you for choosing this Icom product. This product is designed and built with Icom's state of the art technology and craftsmanship. With proper care, this product should provide you with years of trouble-free operation.

This product combines traditional analog technologies with the new digital technology, Digital Smart Technologies for Amateur Radio (D-STAR), for a balanced package.

ABOUT THE CONSTRUCTION OF THE MANUAL

(As of April 2017)

You can use the following manuals to understand and operate this transceiver.

① If necessary, you can download a glossary of HAM radio terms from the Icom website.

Basic manual (Comes with the transceiver)

Instructions for the basic operations, precautions, installation, and connections.

D-STAR Guide (Comes with the transceiver)

Instructions for registering your call sign on a gateway repeater, and the basic operations of D-STAR.

About the DV Gateway function (PDF type)

Instructions on the system requirements or operations needed to use the DV Gateway function.

① The guide "About the DV Gateway function" can be downloaded from the Icom website.

Advanced manual (This manual)

Instructions for advanced operations, as shown below.

- Memory operation <Advanced>*
- Scan operation <Advanced>*
- Priority watch operation
- D-STAR operation <Advanced>*
- GPS operation
- Using a microSD card
- Voice memory operation
- Repeater and duplex operations
- Menu screen <Advanced>*
- Other functions
- Options <Advanced>*
- Bluetooth operation

① This manual can be downloaded from the Icom website.

*The basic instructions are described on the Basic manual.

Icom, Icom Inc. and the Icom logo are registered trademarks of Icom Incorporated (Japan) in Japan, the United States, the United Kingdom, Germany, France, Spain, Russia, Australia, New Zealand, and/or other countries.

Adobe, Acrobat, and Reader are either registered trademarks or trademarks of Adobe Systems Incorporated in the United States and/or other countries.

The Bluetooth word mark and logos are registered trademarks owned by the Bluetooth SIG, Inc. and any use of such marks by Icom Inc. is under license. Other trademarks and trade names are those of their respective owners.

Android and the Android logo are trademarks of Google, Inc.

IOS is a trademark or registered trademark of Cisco in the U.S. and other countries and is used under license.

Apple, iPad, and iPhone are trademarks of Apple Inc., registered in the U.S. and other countries.

App Store is a service mark of Apple Inc.

The iPhone trademark is used under license from iPhone Co., Ltd.

Galaxy and Galaxy S are registered trademarks of Samsung Electronics Co., Ltd.

Google, the Google Logo, Google Play, the Google Play logo,

All other products or brands are registered trademarks or trademarks of their respective holders.

TABLE OF CONTENTS BY TOPIC

Controller		GPS	
Attaching/Installing	Basic manual (sec. 1)	GPS operation	5-2
Front panel	Basic manual (sec. 2)	Checking your GPS position.....	5-3
Display.....	Basic manual (sec. 2)	Checking GPS information (Sky view screen).....	5-11
Power key.....	Basic manual (sec. 3)	Transmitting D-PRS data.....	5-12, 5-13
Microphone		Transmitting NMEA data.....	5-12, 5-25
Connecting	Basic manual (sec. 1)	GPS Logger function	5-34
HM-207S	Basic manual (sec. 2)	GPS Auto transmission.....	5-38
Main unit		D-STAR	
Connecting to a DC power source		Register your call sign on a gateway repeater.....	D-STAR Guide
.....	Basic manual (sec. 1)	“FROM” (Access repeater) setting.....	4-3
Installing in a vehicle	Basic manual (sec. 1)	“TO” (Destination) setting	4-8
Installing an antenna	Basic manual (sec. 1)	Connecting to a Reflector	4-13
Front/Rear panel.....	Basic manual (sec. 2)	Message operation	4-17
Bluetooth		Viewing the received call signs.....	4-19
Installing the UT-137.....	Basic manual (sec. 1)	BK mode communication.....	4-21
Details of Bluetooth operation	12-2	EMR communication	4-22
microSD card		Automatic DV detection.....	4-23
Inserting/Removing.....	Basic manual (sec. 7)	Automatic Reply function.....	4-24
Saving the setting data	6-4	Data communication.....	4-27
Saving with a different file name.....	6-9	Digital call sign squelch/ Digital code squelch functions	4-29
Loading the saved data files that are on a microSD card.....	6-5	Viewing call signs	4-31
Backing up the data saved on a microSD card onto a PC.....	6-6	Repeater list	4-32
Importing or Exporting a CSV formatted file	6-8	Adding Repeater information using the RX History.....	4-39
MENU screen/Quick Menu		Skip setting for a DR scan	4-40
Quick Menu window	Basic manual (sec. 7)	Entering a repeater group name.....	4-41
MENU screen	9-2	Repeater detail screen	4-42
Memory channels		Entering Your (destination) call sign	4-43
Memory channels	1-2	REPEATER AND DUPLEX OPERATIONS	
Manage Memory screen description	1-3	Duplex operation	8-4
Memory name display	1-12	Auto repeater function	8-5
Scan		Off band indication.....	8-5
Scan operation	2-2	VOICE MEMORY	
Setting and clearing a Skip channel	2-8	Recording a QSO audio	7-2
Priority Scan operation	3-2	Playing back the recorded audio	7-3
		Changing the QSO recorder settings	7-4
		Deleting the audio folder/file	7-5
		Viewing the file information.....	7-6
		Viewing the microSD card memory capacity	7-7
		Playing back the recorded audio on the PC	7-8

Functions and features of Adobe® Acrobat® Reader®

The following functions and features can be used with Adobe® Acrobat® Reader®.

• **Keyword search**

Click “Find” (Ctrl+F) or “Advanced Search” (Shift+Ctrl+F) in the Edit menu to open the search screen. This is convenient when searching for a particular word or phrase in this manual.

*The menu screen may differ, depending on the Adobe® Acrobat® Reader® version.

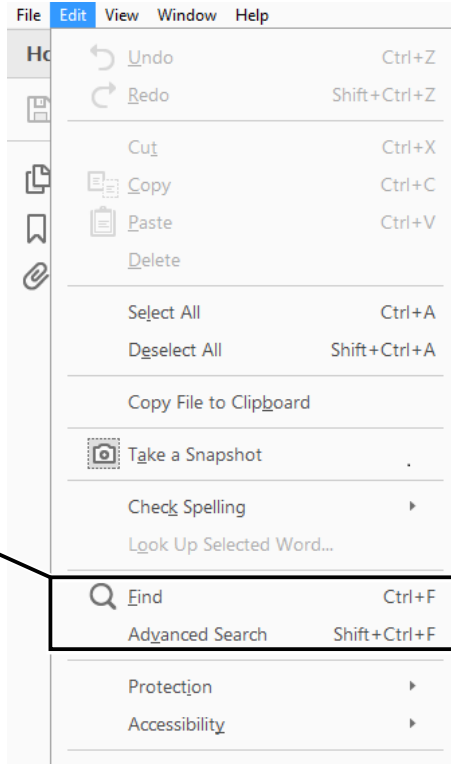

Click to open the find or search screen or advanced search screen.

• **Find screen**

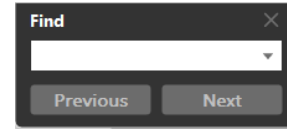

• **Advanced search screen**

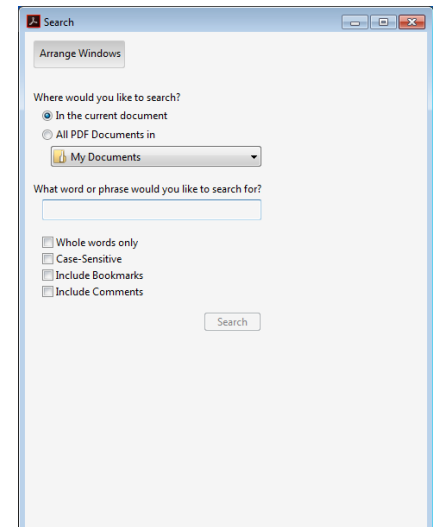

• **Printing out the desired pages.**

Click “Print” in the File menu, and then select the paper size and page numbers you want to print.

*The printing setup may differ, depending on the printer. Refer to your printer’s instruction manual for details.

*Select "A4" size to print out the page in the original manual size.

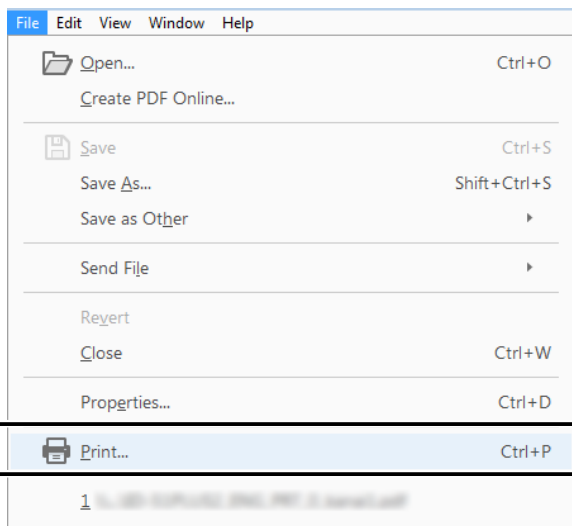

• **Read Out Loud feature.**

The Read Out Loud feature reads aloud the text in this PDF.

Refer to the Adobe® Acrobat® Reader® Help for the details.

(This feature may not be usable, depending on your PC environment including the operating system.)

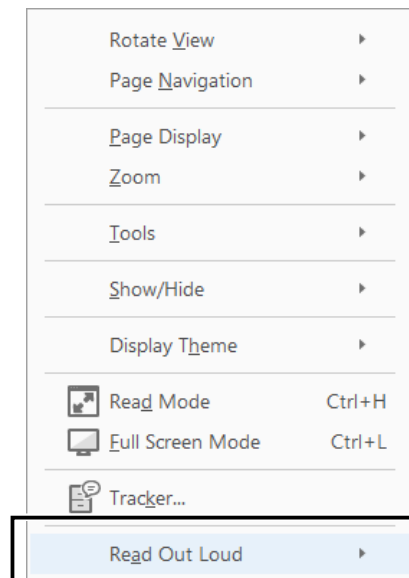

*The screen may differ, depending on the Adobe® Acrobat® Reader® version.

Entering and editing text

Controls used for text entry

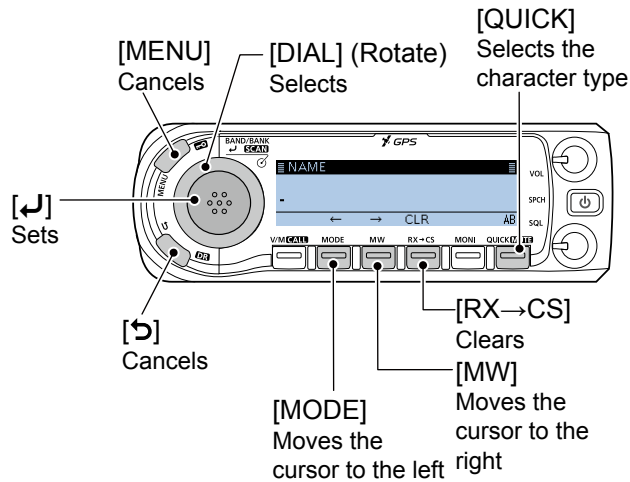

- To insert a text, move the cursor to a place to enter, then rotate [DIAL].
- To clear a character, push [RX→CS].
- To consecutively clear characters, continuously hold down [RX→CS].
- When the character type is "AB" or "ab," and while entering a character, push [QUICK] to convert between upper case and lower case letters.

To change the character type

1. When not selecting text, or an entered text is selected, push [QUICK].
2. Rotate [DIAL] to select the character type, then push [↵].

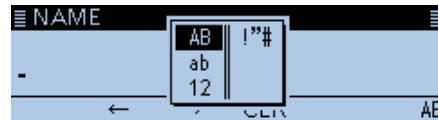

Character type	Selectable characters and symbols	Character conversion
AB	A to Z, (space)	A/a
ab	a to z, (space)	A/a
12	0 to 9, (space)	-
!\"#	! \" # \$ % & ' () * + , - . / : ; < = > ? @ [\\ ^ _ ` { } ~ (space)	-

TIP: When the character type is "AB" or "ab," and while entering a character, push [QUICK] to convert between upper case and lower case letters.

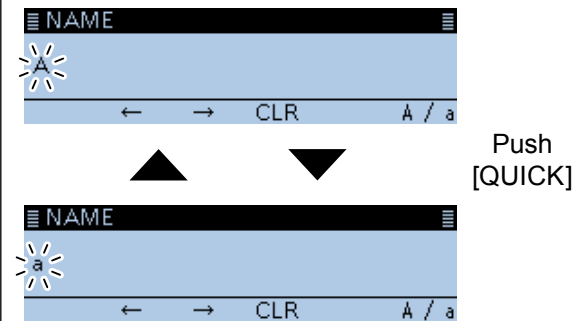

Entering and editing text (Continued)

◆ Usable characters

The usable characters and symbols, and the maximum characters differ, depending on the item.

See the following list for details.

① The usable characters and symbols for each character type are described at the bottom of the page.

Category	Item	Character type	Maximum characters	Information	Reference
Manage Memory	Memory name	[AB] [ab] [12] [!"#]	16	–	p. 1-10
	Bank name	[AB] [ab] [12] [!"#]	16	–	p. 1-11
Program scan	Scan name	[AB] [ab] [12] [!"#]	16	–	p. 2-9
P-LINK	Scan Link name	[AB] [ab] [12] [!"#]	16	–	p. 9-20
My Station	TX Message	[AB] [ab] [12] [!"#]	20	–	p. 4-17
GPS TX Mode	Unproto Address	[AB] [ab] [12] [!"#]	56	Normally 12 characters (API410,DSTAR*)	p. 5-15 p. 5-17 p. 5-21
	Comment	[AB] [ab] [12] [!"#]	43	The number of characters you can enter differs, depending on the data extension and altitude settings.	p. 5-16 p. 5-18 p. 5-22
	Object Name Item Name	[AB] [ab] [12] [!"#]	9	–	p. 5-17
	GPS Message	[AB] [ab] [12] [!"#]	20	–	p. 5-26
SD Card	Save Setting	[AB] [ab] [12] [!"#]	20	Illegal characters: / ; * < >	p. 6-4
	Export	[AB] [ab] [12] [!"#]	20	Illegal characters: / ; * < >	p. 6-9
Bluetooth Set	Device name	[AB] [ab] [12] [!"#]	8	Except for "ICOM BT-"	p. 9-72
Repeater List	Group name	[AB] [ab] [12] [!"#]	16	–	p. 4-41
	Repeater name	[AB] [ab] [12] [!"#]	16	–	p. 4-34
	Sub name	[AB] [ab] [12] [!"#]	8	–	p. 4-34
	Call sign	A to Z, 0 to 9, /, space	8	–	p. 4-34
	GW Call sign	A to Z, 0 to 9, /, space	8	–	p. 4-34
CS screen	UR	A to Z, 0 to 9, /, space	8	–	p. 9-41
	R1	A to Z, 0 to 9, /, space	8	–	p. 9-41
	R2	A to Z, 0 to 9, /, space	8	–	p. 9-41
My Call Sign	Call sign	A to Z, 0 to 9, /, space	12 (+1)	Includes "/" between the Call sign and Memo field.	p. 9-47
Your Call sign	Name	[AB] [ab] [12] [!"#]	16	–	p. 4-43
	Call sign	A to Z, 0 to 9, /, space	8	–	p. 4-43
GPS Memory	Memory name	[AB] [ab] [12] [!"#]	16	–	p. 5-27
	Group name	[AB] [ab] [12] [!"#]	16	–	p. 5-30
DR screen	Direct Input (UR)	A to Z, 0 to 9, /, space	8	–	p. 4-11
	Direct Input (RPT)	A to Z, 0 to 9, /, space	8	–	p. 4-12
DTMF Memory	DTMF code	0 to 9, A, B, C, D, *, #	24	–	p. 10-8

[AB]: A to Z, (space)

[ab]: a to z, (space)

[12]: 0 to 9, (space)

[!"#]: ! " # \$ % & ' () * + , - . / : ; < = > ? @ [\] ^ _ ` { | } ~ (space)

Entering and editing text (Continued)

◆ How to enter

(Example: Entering “Calling” as a Memory name.)

1. Push [MW].
2. Rotate [DIAL] to select “Manage Memory,” then push [↵].

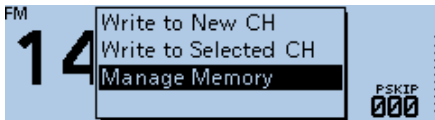

• Displays the MANAGE MEMORY screen.

3. Select “Memory CH,” then push [↵].



4. Select “ALL,” then push [↵].



• Displays the ALL screen.

5. Rotate [DIAL] to select the Memory channel to enter a name, then push [QUICK].

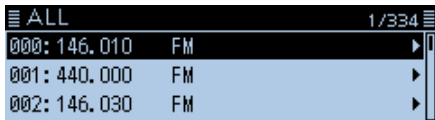

6. Select “Edit,” then push [↵].

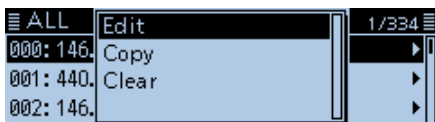

7. Select “NAME,” then push [↵].

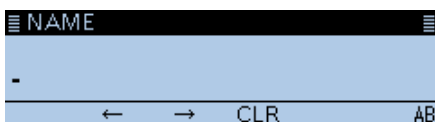
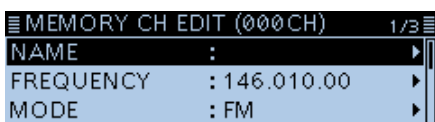

• Enters the name entry mode.

8. Push [QUICK].
9. Select the character type, then push [↵].

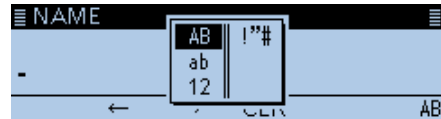

10. Rotate [DIAL] to select a character, then push [↵]. (Example: C)



① Information

- To move the cursor forward, push [MW].
- To move the cursor backward, push [MODE].
- To insert a text, move the cursor to a place to enter, then rotate [DIAL].
- To clear a character, push [RX→CS].
- To consecutively clear characters, continuously hold down [RX→CS].
- When the character type is “AB” or “ab,” and while entering a character, push [QUICK] to convert between upper case and lower case letters.

11. Repeat step 8 ~ 10 to enter a name. (Example: Calling)

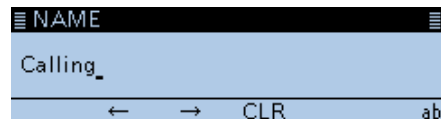

12. After entering, push [↵].

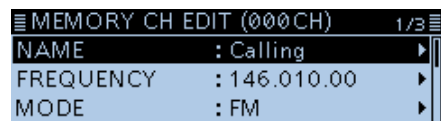

13. Select “<<Overwrite>>,” then push [↵].



• The confirmation dialog “Overwrite?” is displayed.

14. Select <YES>, then push [↵].

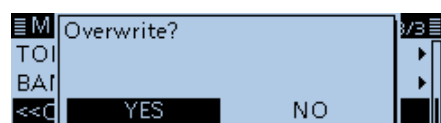

• Beeps sound, and writes the entered name to the channel.

General description	1-2
◇ The number of the Memory channel.....	1-2
◇ Memory channel content	1-2
Manage Memory screen description	1-3
◇ Tree view of the Manage Memory screen.....	1-3
◇ Displaying the Manage Memory screen	1-3
Selecting a Memory channel	1-4
Selecting a Call channel.....	1-4
Writing to a Memory channel.....	1-5
◇ Writing to the selected channel.....	1-5
◇ Writing to a blank channel.....	1-5
◇ Overwriting to the selected channel.....	1-6
◇ Copying Memory content to the VFO	1-6
◇ Copying Memory content to another Memory channel ...	1-7
Memory bank setting	1-8
◇ Assigning a memory channel to a memory bank.....	1-8
◇ Directly writing into a memory bank.....	1-9
◇ Selecting the Memory Bank mode.....	1-9
Entering a Memory or Bank name	1-10
◇ Entering a Memory name	1-10
◇ Entering a Bank name	1-11
Selecting a Memory name display.....	1-12
Clearing a Memory channel.....	1-12

General description

The transceiver has a total of 1000 Memory channels (100 channels in each of 26 memory banks, A ~ Z) and two Call channels (C0/C1) each for the 144 and 430 MHz bands.

The Memory mode is useful to quickly select often-used frequencies.

◇ The number of the Memory channel

Memory Channels	Descriptions
000 ~ 999 (Total of 1000)	Regular Memory channels.
C0/C1	Two Call channels (C0/C1) each for the 144 and 430 MHz bands. Instantly recalls a specified frequency.

◇ Memory channel content

The following information can be entered into the Memory channels:

- Operating frequency
- Duplex direction (DUP+ or DUP-) and frequency offset
- Memory name
- Scan skip setting
- Tuning step
- Operating mode
- Subaudible tone encoder, tone squelch or DTCS squelch ON/OFF
- Subaudible tone frequency, tone squelch frequency or DTCS code with polarity
- UR station call sign
- R1/R2 call signs
- Digital Call sign squelch or Digital code squelch ON/OFF
- Digital code
- Memory bank

NOTE: Memory content may be accidentally cleared by static electricity, electric transients, and other causes. In addition, it may be cleared by a malfunction, or during repairs. Therefore, we recommend that you backup the memory content or save it to a microSD card* or to a PC.

*User supplied

① The CS-4100 cloning software can also be used to backup your memory data.

Manage Memory screen description

The MANAGE MEMORY screen enables you to easily manage the Memory or Call channel content.

- Displays the Memory or Call channel content.
- Easy to assign to a bank, and displays the bank content.
- Easy to add, edit, copy, or clear the Memory channels.

◇ Tree view of the Manage Memory screen

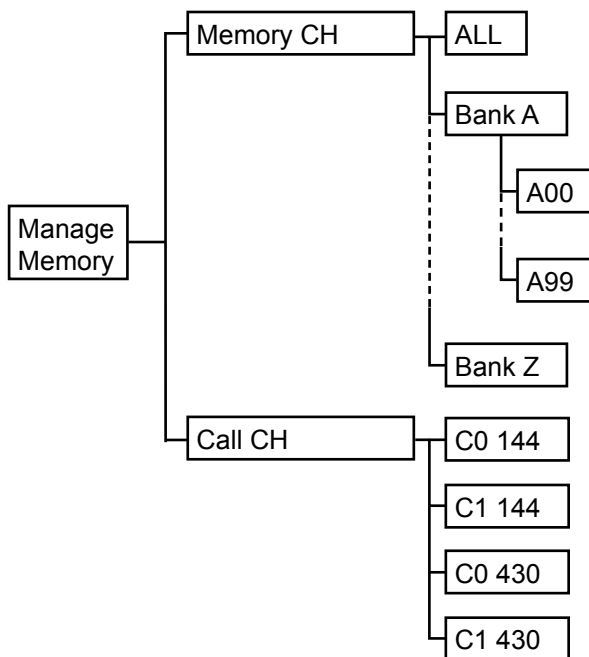

◇ Displaying the Manage Memory screen

Manage Memory > Memory CH

1. Push [MENU].
2. Rotate [DIAL] to select “Manage Memory,” then push [↵].

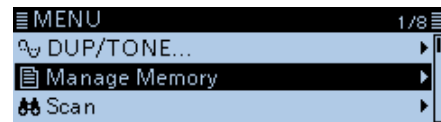

- Displays the MANAGE MEMORY screen.
- ① You can display the MANAGE MEMORY screen by pushing [MW] on other than the DR screen.

3. Select “Memory CH,” then push [↵].



4. Select “ALL,” then push [↵].



- Displays the ALL screen.

5. Select a channel, then push [↵].

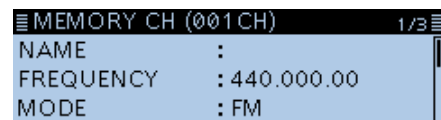
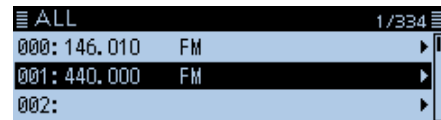

- Displays the Memory content.
- ① Rotate [DIAL] to select the page.

6. Push [MENU].
- Returns to the standby screen.

TIP: To edit, copy or clear the memory content.

1. Push [QUICK] in step 5.
2. Select “Edit,” “Copy” or “Clear,” then push [↵].

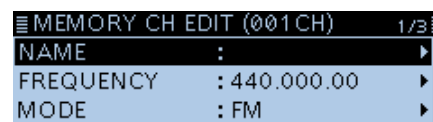
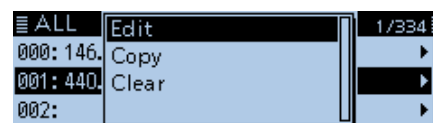

(Example: When selecting “Edit.”)

Selecting a Memory channel

In the Memory mode, you can select the Memory channels by rotating [DIAL].

1. Push [V/M] several times until you enter the Memory mode.



① Pushing [V/M] toggles between the VFO and Memory modes.

2. Rotate [DIAL].
 - Selects a Memory channel.



① Blank channels are not selectable.

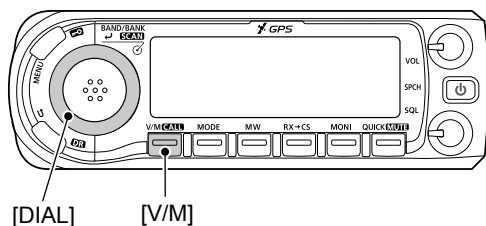

Selecting a Call channel

Two Call channels (C0/C1) are selectable in each of the 144 and 430 MHz bands.

Factory default frequencies and operating modes are entered into the Call channels. Change these to suit your operating needs.

1. Hold down [CALL] for 1 second.
 - Enters the Call channel mode.



① Pushing [CALL] again cancels the Call channel mode.

2. Rotate [DIAL].
 - Selects a Call channel.

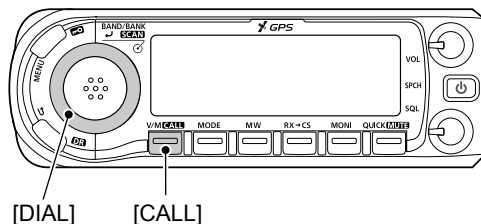

Writing to a Memory channel

After setting a frequency in the VFO mode, you can write it to a selected channel or an automatically selected blank channel. Memory channels 002 to 999 are blank as the default.

◇ Writing to the selected channel

Example: Writing 146.030 MHz into Memory channel 18.

1. Push [V/M] several times until you enter the VFO mode.
2. Rotate [DIAL] to select 146.030 MHz.



3. Push [MW].
4. Rotate [DIAL] to select "Write to New CH."

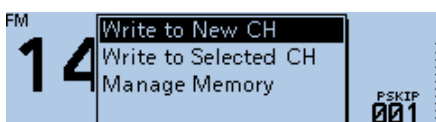

5. Rotate [DIAL] to select the Memory channel "018."

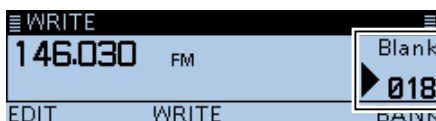

- ① If you select a pre-entered channel, the previous channel content will be overwritten.
- ① The Call channels are also selectable.

6. Push [MW].
 - The confirmation dialog "Write to a blank channel?" is displayed.
7. Select <YES>, then push [↵].

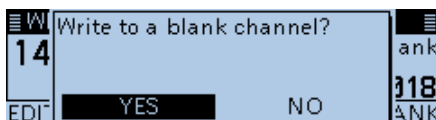

- Beeps sound, and writes into the selected Memory channel.
- Returns to the standby screen (VFO mode).

◇ Writing to a blank channel

Example: Writing 146.030 MHz into a blank channel.

1. Push [V/M] several times until you enter the VFO mode.
2. Rotate [DIAL] to set 146.030 MHz.
3. Hold down [MW] for 1 second.

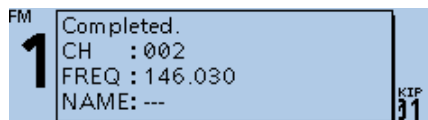

- Beeps sound, and automatically writes into a blank channel.
- Returns to the standby screen (VFO mode).

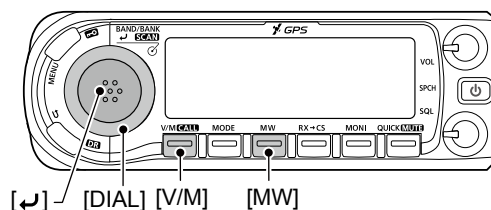

1 MEMORY OPERATION

Writing to a Memory channel (Continued)

◇ Overwriting to the selected channel

You can write a frequency into a pre-entered channel.

Example: Writing 147.030 MHz into Memory channel "018."

1. Push [V/M] several times until you enter the Memory mode.
2. Rotate [DIAL] to select the channel 18.



Destination channel

3. Push [V/M] to enter the VFO mode.
4. Rotate [DIAL] to set 147.030 MHz.



5. Push [MW].
6. Rotate [DIAL] to select "Write to Selected CH," then push [↵].

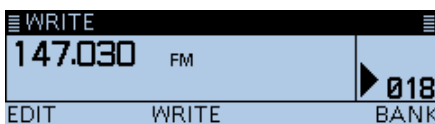
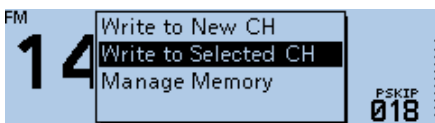

7. Push [MW].
8. Select <YES>, then push [↵].

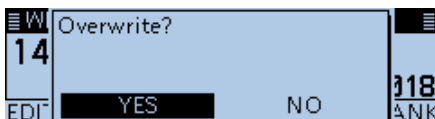

- Beeps sound, and writes into the selected Memory channel.
- Returns to the standby screen (VFO mode).

◇ Copying Memory content to the VFO

It is convenient when you want to operate on a channel frequency near a Memory or Call channel.

Example: Copying Memory channel "001" to the VFO.

1. Push [V/M] several times until you enter the Memory mode.
2. Rotate [DIAL] to select the channel 1.



3. Push [MW].
4. Rotate [DIAL] to select "Copy to VFO," then push [↵].

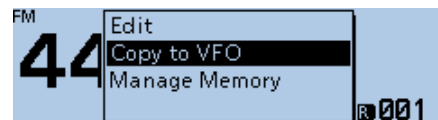

- The confirmation dialog "Copy to VFO?" is displayed.
5. Select <YES>, then push [↵].

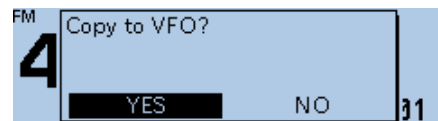

- Beeps sound, and copies the selected Memory content to the VFO.
- Returns to the standby screen (VFO mode).

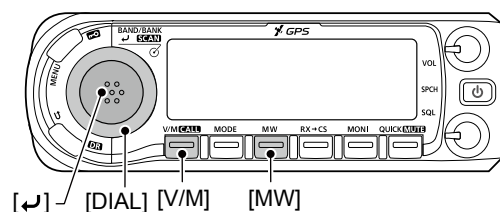

1 MEMORY OPERATION

Writing to a Memory channel (Continued)

◇ Copying Memory content to another Memory channel

You can copy the memory content to another Memory channel.

Example: Copying Memory channel "018" to Memory channel "019".

Manage Memory > Memory CH

1. Push [MENU].
2. Rotate [DIAL] to select "Manage Memory," then push [↵].

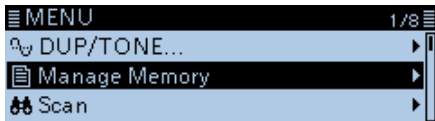

- Displays the MANAGE MEMORY screen.
- ① You can display the MANAGE MEMORY screen by pushing [MW] on other than the DR screen.

3. Select "Memory CH," then push [↵].



4. Select "ALL," then push [↵].



- Displays the ALL screen.

5. Rotate [DIAL] to select the Memory channel "018," then push [QUICK].

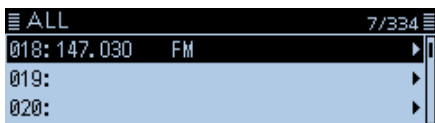

6. Select "Copy," then push [↵].

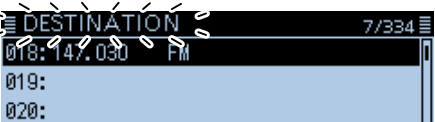

- "DESTINATION" blinks at the top left of the screen.

7. Select the destination channel, then push [↵].

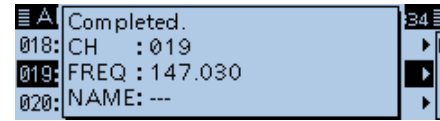

- Beeps sound, and copies to the destination channel.
- ① If you select a pre-entered channel, the previous channel content will be overwritten.

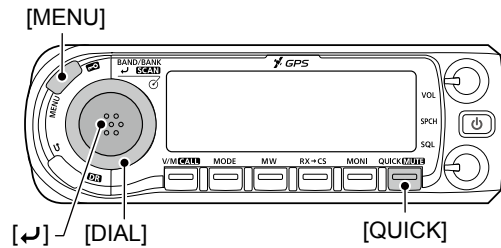

Memory bank setting

The transceiver has a total of 26 banks (A ~ Z). Regular memory channels 0 ~ 999 can be assigned to any bank for easy memory management. Up to 100 channels can be assigned to a bank.

NOTE: The memory banks are only used to hold memory channels. Therefore, if the original memory channel content have been changed, the memory bank content are also changed at the same time.

◇ Assigning a memory channel to a memory bank

Example: Assigning Memory channel “000” to the bank “A”.

Manage Memory > Memory CH

1. Push [MENU].
2. Rotate [DIAL] to select “Manage Memory,” then push [↵].

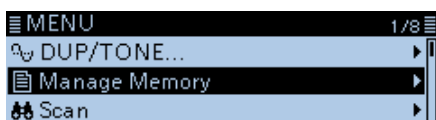

- Displays the MANAGE MEMORY screen.
- ① You can display the MANAGE MEMORY screen by pushing [MW] on other than the DR screen.

3. Select “Memory CH,” then push [↵].



4. Select “ALL,” then push [↵].



- Displays the ALL screen.

5. Rotate [DIAL] to select the Memory channel to be assigned to a bank, then push [QUICK].

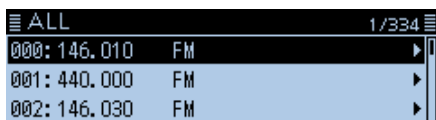

6. Select “Edit,” then push [↵].



7. Select “BANK,” then push [↵].

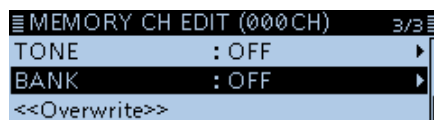

8. Select a bank to be assigned, then push [↵].



9. Select “<<Overwrite>>,” then push [↵].



- The confirmation dialog “Overwrite?” is displayed.

10. Select <YES>, then push [↵].

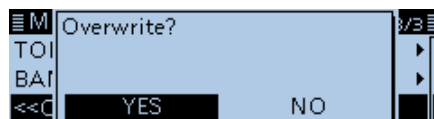

- Beeps sound, and assigns the selected memory channel to the bank.

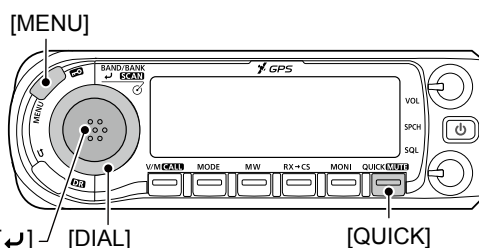

1 MEMORY OPERATION

Memory bank setting (Continued)

◇ Directly writing into a memory bank

You can also write the memory content directly into a memory bank channel. This way is a short cut to creating a memory channel, and then assigning it to a bank. In that case, the transceiver automatically selects the lowest blank memory channel, to write.

Example: Writing 146.030 MHz into Bank A.

1. Push [V/M] several times until you enter the VFO mode.
2. Rotate [DIAL] to set 146.030 MHz.
3. Push [MW].
4. Rotate [DIAL] to select "Write to New CH," then push [↵].

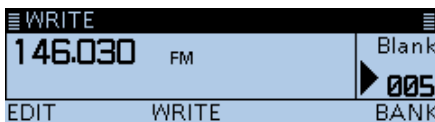
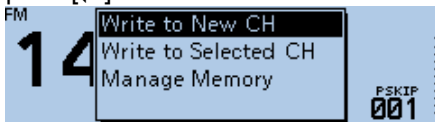

• Displays the WRITE screen.

5. Push [QUICK].
6. Select a bank, then push [↵].

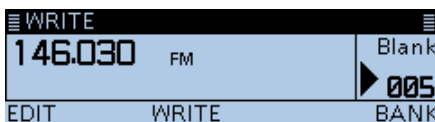

7. Push [MW].
 - The confirmation dialog "Write to a blank channel?" is displayed.
8. Select <YES>, then push [↵].

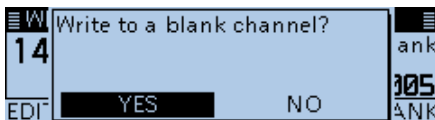

• Beeps sound, and writes the memory content to the bank channel.

TIP: On the WRITE screen, you can select other channel by rotating [DIAL].

① If you select a pre-entered channel, the previous channel content will be overwritten.

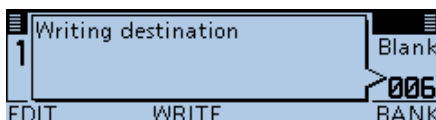

◇ Selecting the Memory Bank mode

When you select the Memory Bank mode, rotating [DIAL] selects only the entered bank channels in the selected bank.

1. Push [V/M] several times until you enter the Memory mode.
2. Push [QUICK].
3. Rotate [DIAL] to select "Bank Select," then push [↵].

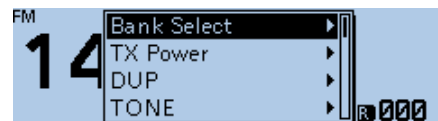

4. Select a bank, then push [↵].

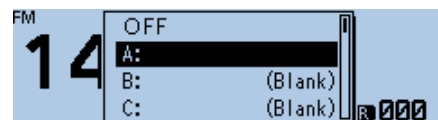

5. Rotate [DIAL] to select a bank channel.

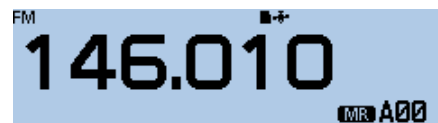

① Only assigned bank channels are selectable.

② To return to the Memory mode, select "OFF" in step 4.

TIP: After step 5, you can write the displayed content to the bank channel.

1. After step 5, push [V/M] to enter the VFO mode.
2. Set the frequency, then push [MW].
3. Rotate [DIAL] to select "Write to New CH," then push [↵].

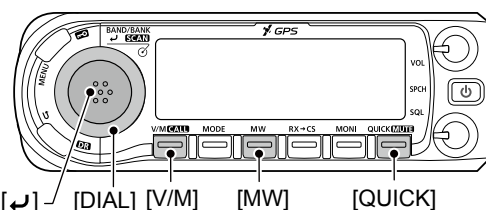
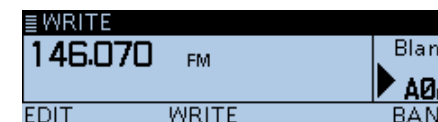
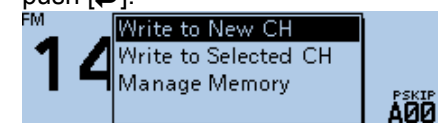

Entering a Memory or Bank name

You can enter an alphanumeric name for each Memory, including Call channels, and Banks. Names can be a maximum of 16 characters.

◇ Entering a Memory name

Manage Memory > Memory CH

1. Push [MENU].
2. Rotate [DIAL] to select “Manage Memory,” then push [↵].

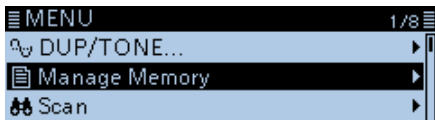

- Displays the MANAGE MEMORY screen.
- ① You can display the MANAGE MEMORY screen by pushing [MW] on other than the DR screen.

3. Select “Memory CH,” then push [↵].



4. Select “ALL,” then push [↵].



- Displays the ALL screen.

5. Rotate [DIAL] to select the Memory channel to enter a name, then push [QUICK].

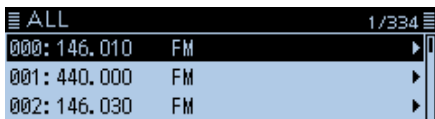

6. Select “Edit,” then push [↵].



7. Select “NAME,” then push [↵].

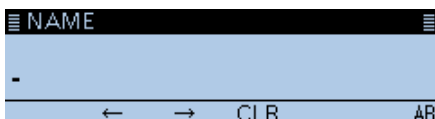

- Enters the name entry mode.

8. Enter a name of up to 16 characters. (Example: Calling)



Selectable characters and symbols

A to Z, a to z, 0 to 9, ! " # \$ % & ' () * + , - . / : ; < = > ? @ [\] ^ _ ` { | } ~ (space)

- ① See “Entering and editing text” for details. (p. iv)

9. After entering, push [↵].

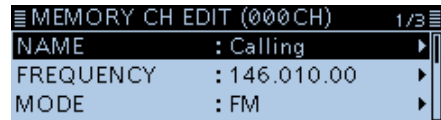

10. Select “<<Overwrite>>,” then push [↵].



- The confirmation dialog “Overwrite?” is displayed.

11. Select <YES>, then push [↵].

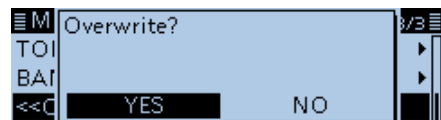

- Beeps sound, and writes the entered name to the channel.

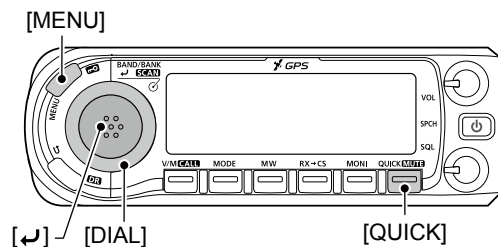

1 MEMORY OPERATION

Entering a Memory or Bank name (Continued)

◇ Entering a Bank name

Manage Memory > Memory CH

1. Push [MENU].
2. Rotate [DIAL] to select “Manage Memory,” then push [↵].

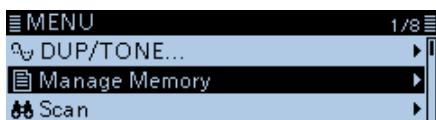

- Displays the MANAGE MEMORY screen.
- ① You can display the MANAGE MEMORY screen by pushing [MW] on other than the DR screen.

3. Select “Memory CH,” then push [↵].



4. Select a bank group to enter a name, then push [QUICK].

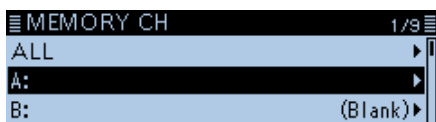

5. Select “Edit Name.”

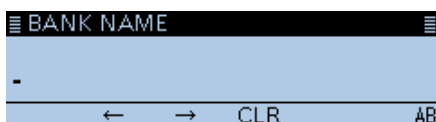
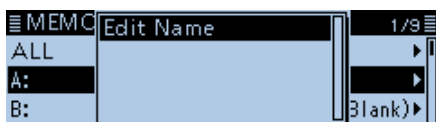

- Enters the bank name entry mode.

6. Enter a bank name of up to 16 characters. (Example: Contest)

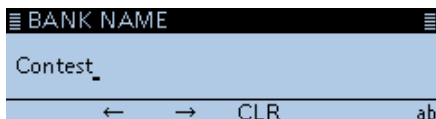

Selectable characters and symbols

A to Z, a to z, 0 to 9, ! " # \$ % & ' () * +
 , - . / : ; < = > ? @ [\] ^ _ ` { | } ~ (space)

- ① See “Entering and editing text” for details. (p. iv)

7. After entering, push [↵].

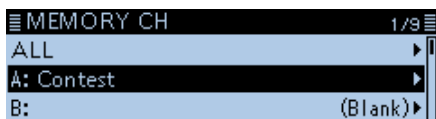

- Beeps sound, and writes the entered name to the bank.

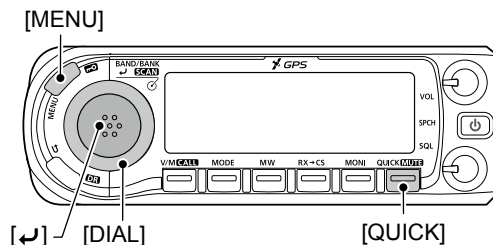

Selecting a Memory name display

The transceiver has two Memory name display types.

1. Push [V/M] several times until you enter the Memory mode.
2. Push [QUICK].
3. Rotate [DIAL] to select "Display Type," then push [↵].

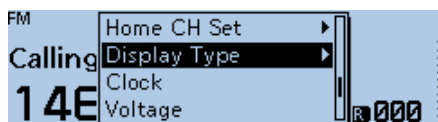

4. Select the display type, then push [↵].

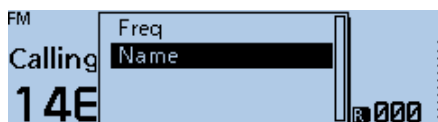

- Freq:
Displays the large font sized frequency and small font sized memory name.

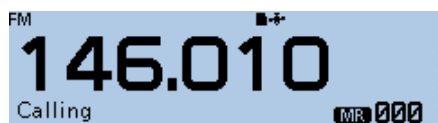

- Name:
Displays large font sized memory name and a small font sized frequency.

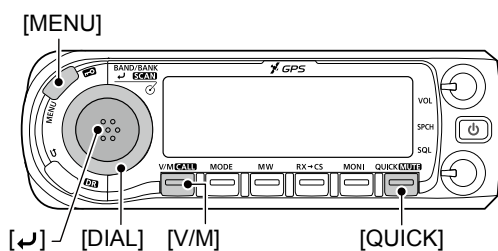

Clearing a Memory channel

Entered memory content can be cleared.

Manage Memory > Memory CH

1. Push [MENU].
2. Rotate [DIAL] to select "Manage Memory," then push [↵].

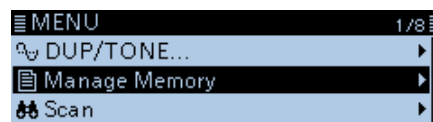

- Displays the MANAGE MEMORY screen.
① You can display the MANAGE MEMORY screen by pushing [MW] on other than the DR screen.

3. Select "Memory CH," then push [↵].



4. Select "ALL," then push [↵].



- Displays the ALL screen.

5. Rotate [DIAL] to select the Memory channel to be cleared, then push [QUICK].

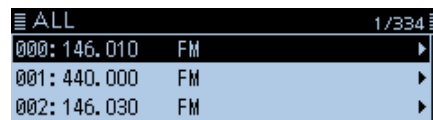

6. Select "Clear," then push [↵].

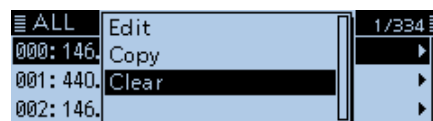

- The confirmation dialog "Clear?" is displayed.

7. Select <YES>, then push [↵].

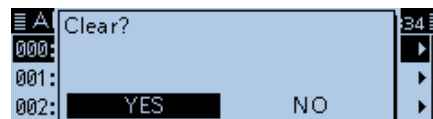

- Beeps sound, and clears the memory content.

Scan	2-2
◇ About the scan function	2-2
◇ VFO scan	2-2
◇ Memory scan	2-2
◇ Memory bank scan	2-2
◇ [DIAL] operation during a scan	2-3
◇ Squelch setting for a scan	2-3
◇ Tuning step for a VFO scan	2-3
◇ Skip function	2-3
◇ Temporary Skip timer	2-3
◇ Receive mode during a scan	2-3
◇ When a signal is received	2-3
◇ Scan Stop Beep function	2-3
VFO mode scan.....	2-4
◇ Scan type	2-4
◇ About a Scan name	2-5
◇ About a Program Link name	2-5
◇ Setting the skip frequencies.....	2-5
Memory scan	2-6
◇ Scan type	2-6
Memory Bank scan.....	2-7
◇ Scan type	2-7
◇ About a Bank name	2-7
Setting and clearing the skip channel.....	2-8
Entering scan edges	2-9

Scan

Scanning is a versatile function that can automatically search for signals. A scan makes it easier to locate stations to contact or listen to, or to skip unwanted channels or frequencies.

◇ About the scan function

In the VFO mode

The frequencies that are set as “PSKIP” are skipped during a scan. (p. 2-5, 9-18)

◇ VFO scan

ALL (Full scan)

Repeatedly scans the entire band.

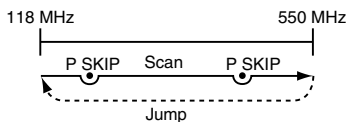

BAND (Selected band scan)

Scans all frequencies over the entire selected band.

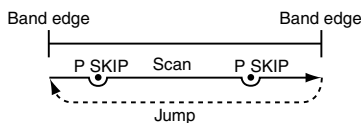

PROG 0 ~ 24 (Program scan)

Scans the Program scan edge ranges.

(Scan > **Program Scan Edge**) (p. 2-9, 9-18)

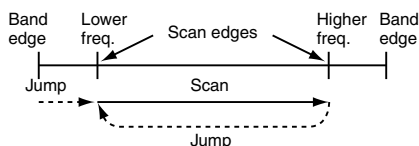

① At least one Program scan edge range must be entered to start a Program scan.

P-LINK0-9 (Program link scan)

Sequentially scans the Program scan edge ranges which are set to link on the MENU screen.

(p. 9-19)

(Scan > **Program Link**)

In the Memory mode

Repeatedly scans all entered Memory channels.

The frequencies that are set as skip channels “PSKIP” and “SKIP” are not scanned. (p. 2-8)

① Two or more Memory channels must be entered to start a memory scan.

◇ Memory scan

ALL (Memory full scan)

Scans all Memory channels.

BAND (Selected band memory scan)

Scans all Memory channels on the same frequency band as the selected channel.

MODE (Mode memory scan)

Scans Memory channels which are entered with the same receiving mode as the currently selected mode.

◇ Memory bank scan

ALL (Full bank scan)

Scans all banks.

BANK-LINK (Bank link scan)

Sequentially scans the banks which are set to link on the MENU screen. (p. 9-18)

(Scan > **Bank Link**)

BANK-A-Z (Bank scan)

Scans the Memory channels in the selected bank.

Duplex (DUP) scan

The Duplex scan searches for both TX and RX frequencies which are used in duplex operation.

(p. 8-4)

① “D-” or “D+” is displayed in the Duplex mode.

① A Duplex scan does not start when the frequency offset is set to “0.000 MHz.”

Tone scan

The Tone scan searches for tone frequencies or DTCS codes that are used by stations using the Tone Squelch function.

① A Tone scan is usable in any VFO, Memory, or Call channel mode.

① During a scan, rotate [DIAL] to change the scan direction.

See “Tone Squelch function” or “DTCS code Squelch function” for details. (pp. 10-11, 10-12)

Scan (Continued)

◇ **[DIAL] operation during a scan**

- Rotate [DIAL] to change the scan direction during a scan.
- When the scan is paused, rotate [DIAL] to resume the scan.

◇ **Squelch setting for a scan**

You can change the squelch level to suit your operating needs. Set the squelch level to open the squelch, according to the received signal strength. During a scan, rotate [SQL] to adjust the squelch level.

◇ **Tuning step for a VFO scan**

The selected tuning step is applied to the scan. For a Program scan or Program Link scan, set the tuning step in the Program Scan Edge ranges. (p. 2-9)

◇ **Skip function**

The skip function speeds up scanning by not scanning those frequencies set as skip channels. (pp. 2-5, 2-8)

TIP: When “Program Skip” is set to OFF, you cannot use the Scan Skip function. (p. 9-18)
(Scan > **Program skip**)

◇ **Temporary Skip timer**

The Temporary Skip function temporarily skips unwanted frequencies during a scan, for the set period of time.

- These settings can be changed on the MENU screen. (p. 9-18)
(Scan > **Temporary Skip Timer**)

◇ **Receive mode during a scan**

- The VFO scan uses the selected receive mode.
 - ① For a Program scan or Program Link scan, set the tuning step in the Program Scan Edge ranges. (p. 2-9)
- During a Memory or Bank scan, the mode entered into the channel is used.

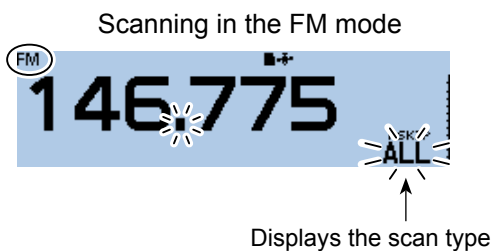

◇ **When a signal is received**

When a signal is received, the scan pauses for approximately 10 seconds (default), then resumes. The scan resumes approximately 2 seconds (default) after the signal disappears.

To manually resume the scan, rotate [DIAL].

- ① These settings can be changed on the MENU screen. (p. 9-18)
(Scan > **Pause Timer**)
(Scan > **Resume Timer**)



The S-meter displays the received signal strength.

◇ **Scan Stop Beep function**

The Scan Stop Beep function sounds a beep when a signal is received.

This function can be turned ON or OFF on the MENU screen. (p. 9-66)

(Sounds > **Scan Stop Beep**)

When receiving a signal



VFO mode scan

1. Push [V/M] several times until you enter the VFO mode.
2. Hold down [SCAN] for 1 second.
 - Opens the Scan Type Select window.
 - ① If you hold down [SCAN] for 3 seconds, the last selected scan starts.
3. Rotate [DIAL] to select a scan type, then push [↵].
 - The scan starts.

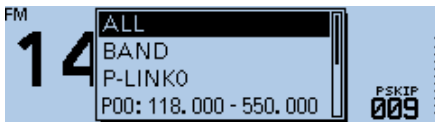

- ① The decimal point and the selected scan type icon blink.
- ① When receiving a signal, the S-meter displays the received signal strength.
4. Push [SCAN].
 - Cancels the scan.

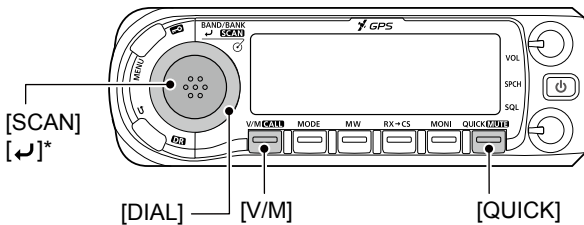

*The key operation may differ, depending on the operating status.

◇ Scan type

The VFO mode scan has 6 scan types.

- ALL: Full scan
- BAND: Band scan
- P-LINK0 ~ 9: Program link scan
- P00 ~ 24: Program scan
- DUP: Duplex scan
(Displayed only when duplex is set.)
- TONE: Tone scan
(For the Tone Squelch scanning)

- ① The frequencies that are set as a Skip channel (PSKIP) are skipped during a scan. (p. 2-8)
- ① When "Program Skip" is set to "OFF," the Skip channel frequencies are not skipped. (p. 9-18)
(Scan > **Program Skip**)

TIP:

- During a scan, rotating [DIAL] changes the scanning direction.
- During a scan, you can change the operating band, scan edge, and so on, in the Quick Menu window.
- The scan continuously runs, even if you push [MENU] or [QUICK] during a scan.
- You can set the tuning step and the operating mode used for a Program scan or Program Link scan. (p. 2-9)
- The transceiver can receive on the AIR, 144 MHz, 230 MHz, 300 MHz, and 430 MHz bands.*
*Selectable band differs, depending on the transceiver's version.
- ① You can transmit on only the amateur band frequencies.

VFO mode scan (Continued)

◇ About a Scan name

When a Scan name is assigned, the name is displayed in the Scan Type Select window. (p. 2-4)

- ① The Scan name is not displayed during a scan.
- ① See page 2-9 to enter the scan name.

When the Scan name is assigned



When the Scan name is not assigned



◇ About a Program Link name

When a Program Link name is assigned, the name is displayed in the Scan Type Select window. (p. 2-4)

- ① The Program Link name is not displayed during a scan.
- ① See page 2-9 to enter the program link name.

When the Program Link name is assigned



When the Program Link name is not assigned

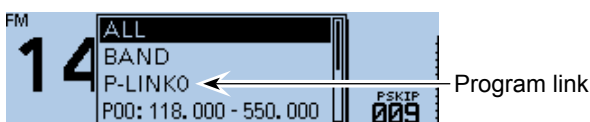

◇ Setting the skip frequencies

You can set unnecessary frequencies as Skip channels (PSKIP) to be skipped during a scan. The Skip function speeds up a scan.

1. Start the VFO scan.
 - When a signal is received, the scan pauses.
2. Push [QUICK].
3. Rotate [DIAL] to select "SKIP."

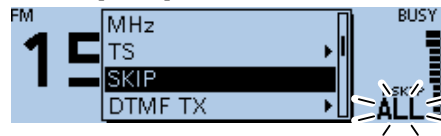

- Sets the frequency as a Skip channel into empty Memory channel 999.
 - The entered Memory channel number blinks.
 - ① If channel 999 already has content, the transceiver automatically searches for another blank channel to use. If there is no blank channel, a beep sounds, and the frequency is not set as a Skip channel.
4. After setting, the scan resumes.

TIP: Once frequencies are set as a Skip channel, these frequencies are skipped until clearing the skip setting. To clear the skip setting, see page 2-8 for details.

① The skip setting is also cleared when the Memory channel set as a Skip channel is cleared. (p. 1-12)

Memory scan

NOTE: Two or more Memory channels, which are not set as Skip channels, must be entered to start a Memory scan.

1. Push [V/M] several times until you enter the Memory mode.
 - Opens the Scan Type Select window.
2. Hold down [SCAN] for 1 second.
 - Opens the Scan Type Select window.
 - ① If you hold down [SCAN] for 3 seconds, the last selected scan starts.
3. Rotate [DIAL] to select a scan type, then push [↵].
 - The scan starts.

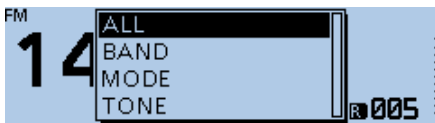

- ① The decimal point and MR blink.
- ① When receiving a signal, the S-meter displays the received signal strength.
4. Push [SCAN].
 - Cancels the scan.

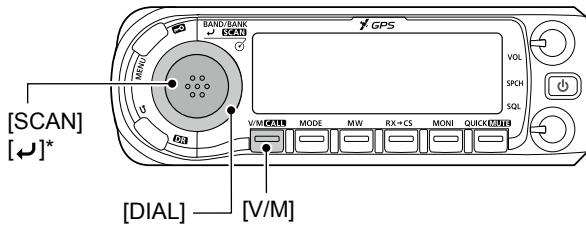

*The key operation may differ, depending on the operating status.

◇ Scan type

The Memory mode scan has 5 scan types.

- ALL: Full scan
- BAND: Band Memory scan
- MODE: Mode Memory scan
- DUP: Duplex scan
(Displayed only when duplex is set.)
- TONE: Tone scan
(For the Tone squelch scanning)

- ① When two or more Memory channels, which are not set as Skip channels, are entered, the Memory scan is usable.
- ① The channels that are set as a Skip channel (PSKIP or SKIP) are skipped during a scan. (p. 2-8)

TIP:

- During a scan, rotating [DIAL] changes the scanning direction.
- The scan continuously runs, even if you push [MENU] or [QUICK] during a scan.

Memory Bank scan

A Memory Bank scan searches through the Memory channels in the selected bank.

① Two or more Memory channels, which are not set as skip channels, must be entered to start a Memory Bank scan. (p. 1-8)

1. Push [V/M] several times until you enter the Memory mode.
2. Push [QUICK].
3. Rotate [DIAL] to select "Bank Select," then push [↵].

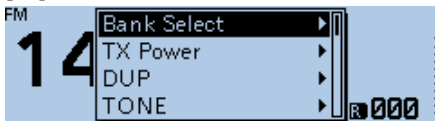

4. Select a bank to be scanned, then push [↵].

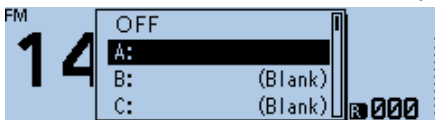

5. Hold down [SCAN] for 1 second.
 - Opens the Scan Type Select window.
 - ① If you hold down [SCAN] for 3 seconds, the last selected scan starts.
6. Rotate [DIAL] to select a scan type, then push [↵].
 - The scan starts.

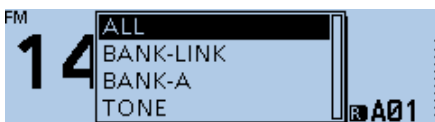

- ① The decimal point and MR blink.
- ① When receiving a signal, the S-meter displays the received signal strength.
7. Push [SCAN].
 - Cancels the scan.

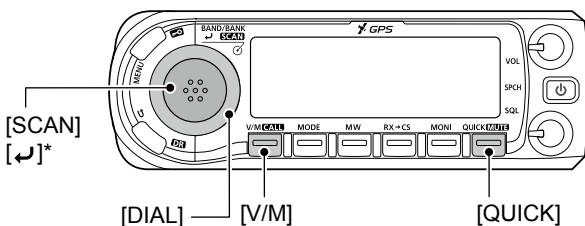

*The key operation may differ, depending on the operating status.

◇ Scan type

- ALL: Full bank scan
- BANK-LINK: Bank link scan
- BANK-A ~ Z: Bank scan
(Displays only banks which contain a Memory channel.)
- DUP: Duplex scan
(Displayed only when duplex is set on the channel.)
- TONE: Tone scan (For tone scanning)

- ① When all channels are set as "SKIP" or "PSKIP," the bank is skipped during a Bank Link scan. (p. 2-8)
- ① When all channels in the selected bank are set as "SKIP" or "PSKIP," the scan does not start.
- ① When two or more Memory channels, which are not set as Skip channels, are entered in a bank, the Memory bank scan is usable. (p. 2-7)

TIP:

- During a scan, rotating [DIAL] changes the scanning direction.
- The scan continuously runs, even if you push [MENU] or [QUICK] during a scan.
- During a scan, you can change the bank to be scanned on the Quick Menu window.

◇ About a Bank name

When a Bank name is assigned, the name is displayed on the Scan Type Select window.

- ① The scan name is not displayed during a scan.
- ① See page 1-11 to enter the Bank name.

When the Bank name is assigned

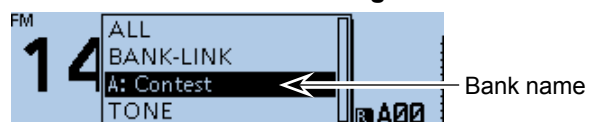

When the Bank name is not assigned

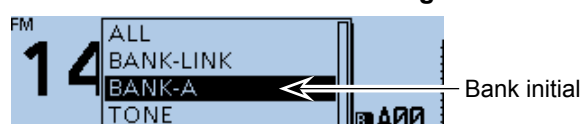

Setting and clearing the skip channel

You can set or clear a Skip channel setting. The channels that are set as a Skip channel are skipped during a scan.

1. Push [V/M] several times until you enter the Memory mode.
2. Rotate [DIAL] to select the Memory channel.



3. Push [QUICK].
4. Rotate [DIAL] to select "SKIP," then push [↵].

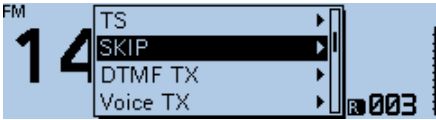

5. Select the option, then push [↵].
 - OFF: Cancel the skip setting.
 - SKIP: Skipped during a memory scan.
 - PSKIP: Skipped during both VFO and memory scans.

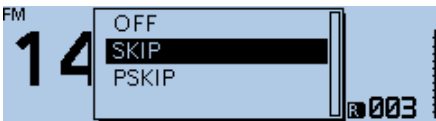

- When a Skip channel is set, "SKIP" or "PSKIP" is displayed.

TIP: To clear the skip channel setting
 To clear the skip channel setting, select "OFF" in step 5, then push [↵].

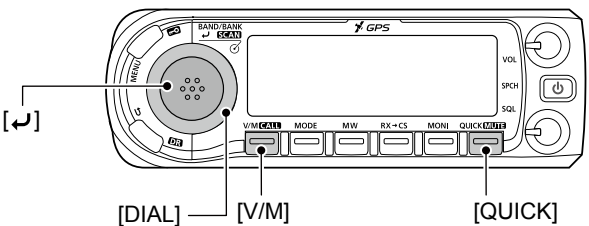

Entering scan edges

You can enter the upper and lower frequency edges to the Program scan edge ranges for Program scans. Each Program scan edge range has its own tuning step and the receive mode. The default setting is differ, depending on the transceiver version. You can enter a total of up to 25 Program scan edge ranges.

Scan > Program Scan Edge

1. Push [MENU].
2. Rotate [DIAL] to select "Scan," then push [↵].

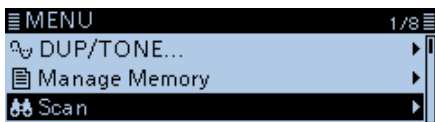

- Displays the SCAN screen.

3. Select "Program Scan Edge," then push [↵].



4. Select a scan edge channel.

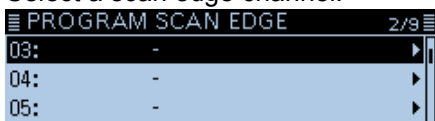

5. Push [QUICK].
6. Select "Edit," then push [↵].



7. Select "NAME," then push [↵].

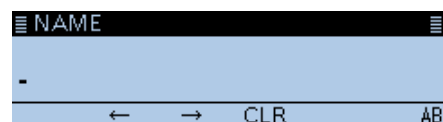
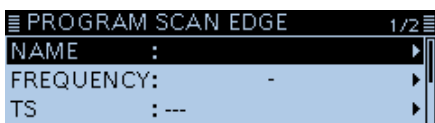

- Enter the name entry mode.

8. Enter a name of up to 16 characters, then push [↵]. (Example: Air)

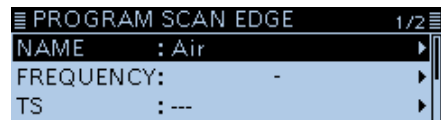
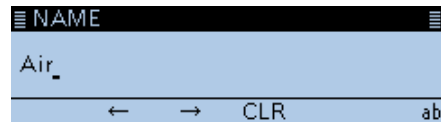

Selectable characters and symbols

A to Z, a to z, 0 to 9, ! " # \$ % & ' () * + , - . / : ; < = > ? @ [\] ^ _ ` { | } ~ (space)

9. Select "FREQUENCY," then push [↵].

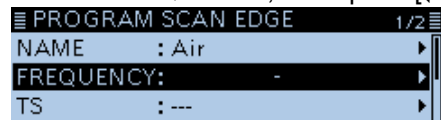

10. Rotate [DIAL] to set a lower frequency, then push [↵]. (Example: 118000)



11. Set a higher frequency, then push [↵]. (Example: 136000)

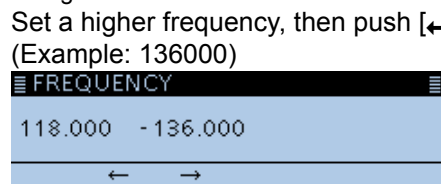

12. Select "TS," then push [↵].

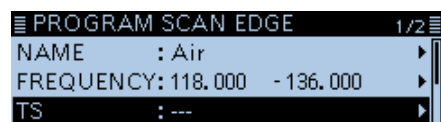

- Displays the selectable tuning step.

13. Select the tuning step to be used during a scan.



- ① When you select "--," the tuning step set in the VFO mode is used during a scan.

2 SCAN OPERATION

Entering scan edges (Continued)

14. Select "MODE," then push [↵].

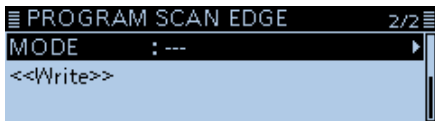

- Displays the selectable mode.

15. Select the receive mode to be used during a scan.



- ① When you select "---," the receive mode set in the VFO mode is used during a scan.

16. Select "<<Write>>," then push [↵].

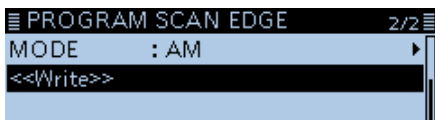

- The confirmation dialog "Write?" is displayed.

17. Select <YES>, then push [↵].



- Beeps sound, and automatically writes into the selected scan edge channel.
- Returns to the PROGRAM SCAN EDGE screen.

Section 3

PRIORITY WATCH

Priority watch	3-2
◇ Starting the Priority watch	3-2
◇ Canceling the Priority watch	3-2
VFO frequency and a Priority channel.....	3-3
◇ When a signal is received.....	3-3
VFO frequency and a Memory/Bank scan.....	3-4
◇ When a signal is received.....	3-4
VFO scan and a Priority channel.....	3-5
◇ When a signal is received.....	3-5
VFO scan and a Memory/Bank scan.....	3-6
◇ When a signal is received.....	3-6
Scanning “FROM” on the DR screen and a Priority channel..	3-7
◇ When a signal is received.....	3-7
DR scan and a Priority channel.....	3-8
◇ When a signal is received.....	3-8

Priority watch

While operating on a VFO frequency, using the DR function or while scanning, Priority watch checks for signals on a selected frequency every 5 seconds.

◇ Starting the Priority watch

To start the Priority watch, select “ON” or “Bell,” as described below.

1. Push [QUICK].
2. Rotate [DIAL] to select “PRIO Watch,” then push [↵].

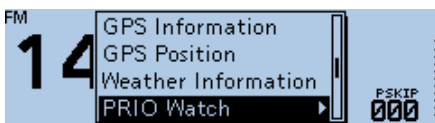

3. Select an option, then push [↵].
 - ON: Starts Priority Watch.
When a signal is received on the Priority channel, the channel is automatically selected.
 - Bell: Starts Priority Watch.
When a signal is received on the Priority channel, the “(•) ” icon blinks.

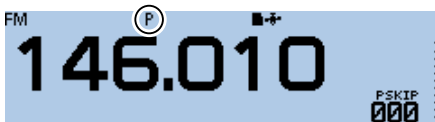

- “P” is displayed, and the Priority watch starts.

◇ Canceling the Priority watch

1. Push [QUICK].
2. Rotate [DIAL] to select “PRIO Watch OFF,” then push [↵].

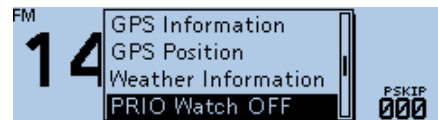

- “P” disappears, and the Priority watch is canceled.

VFO frequency and a Priority channel

Checks the selected Priority channel every 5 seconds, while receiving on a VFO frequency.

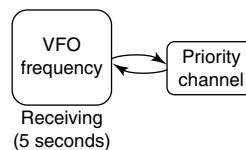

Step 1. Set the VFO frequency

(See Basic manual section 3)

1. Push [V/M] several times until you enter the VFO mode.
2. Set the receive frequency and mode you want to monitor.

Step 2. Set the Priority channel

To select a Memory channel (p. 1-4)

1. Push [V/M] to enter the Memory mode.
2. Rotate [DIAL] to select the Memory channel you want to monitor.

To select a Bank channel (p. 1-9)

1. Push [V/M] to enter the Memory mode.
2. Push [QUICK].
3. Rotate [DIAL] to select "Bank Select," then push [↵].
4. Rotate [DIAL] to select the Bank channel you want to monitor.

To select a Call channel (p. 1-4)

1. Hold down [CALL] for 1 second to enter the Call channel mode.
2. Rotate [DIAL] to select the Call channel you want to monitor.

Step 3. Starts the Priority watch (p. 3-2)

1. Push [QUICK].
2. Rotate [DIAL] to select "PRIO Watch," then push [↵].
3. Select the Priority watch option, then push [↵].
 - "P" is displayed, and the Priority watch starts.

Example: Checks Memory channel "002" while receiving on 146.010 MHz.

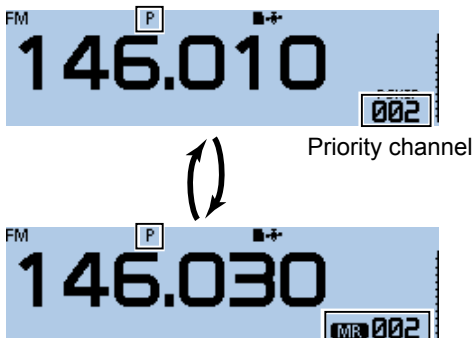

Checks Memory channel "002" every 5 seconds.

Step 4. Canceling the Priority watch (p. 3-2)

1. Push [QUICK].
2. Rotate [DIAL] to select "PRIO Watch OFF," then push [↵].
 - "P" disappears, and the Priority watch is canceled.

◇ When a signal is received

When "ON" is selected.

When a signal is received on the Priority channel, the channel is automatically selected.

- The "P" icon blinks.
- ① The scan pause timer and resume settings are the same as those for a normal scan. (p. 9-18)



Automatically selects the Priority channel.

When "Bell" is selected.

When a signal is received on the Priority channel, the display remains in the VFO mode.

- A beep sounds and the "(•)" icon blinks.



Remains in the VFO mode.

VFO frequency and a Memory/Bank scan

Sequentially checks the Memory or Bank channels every 5 seconds, while receiving on a VFO frequency.

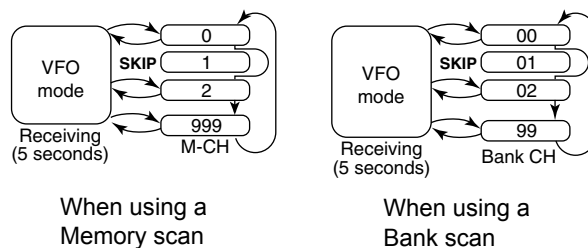

Step 1. Set the VFO frequency (See Basic manual section 3)

1. Push [V/M] several times until you enter the VFO mode.
2. Set the receive frequency and mode you want to monitor.

Step 2. Start a Memory or Bank scan

To start a Memory scan (p. 2-6)

1. Push [V/M] to enter the Memory mode.
2. Hold down [SCAN] for 1 second.
 - Opens the Scan Type Select window.
3. Rotate [DIAL] to select a scan type, then push [↵].
 - The scan starts.

To start a Bank scan (p. 2-7)

1. Push [V/M] to enter the Memory mode.
2. Push [QUICK].
3. Rotate [DIAL] to select "Bank Select," then push [↵].
4. Select a bank to be scanned, then push [↵].
5. Hold down [SCAN] for 1 second.
 - Opens the Scan Type Select window.
6. Rotate [DIAL] to select a scan type, then push [↵].
 - The scan starts.

Step 3. Starts the Priority watch (p. 3-2)

1. Push [QUICK].
2. Rotate [DIAL] to select "PRIO Watch," then push [↵].
3. Select the Priority watch option, then push [↵].
 - "P" is displayed, and the Priority watch starts.

Example: Sequentially checks the Memory channels while receiving on 146.010 MHz.

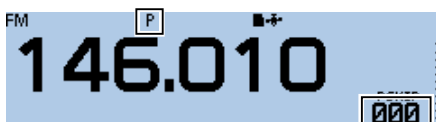

The Memory channels are sequentially checked.

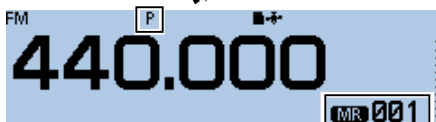

Checks the Memory channels every 5 seconds.

Step 4. Canceling the Priority watch (p. 3-2)

1. Push [QUICK].
2. Rotate [DIAL] to select "PRIO Watch OFF," then push [↵].
 - "P" disappears, and the Priority watch is canceled.
 - ① The Memory or Bank scan is also canceled.

◇ When a signal is received

When "ON" is selected.

When a signal is received on the Priority channel, the channel is automatically selected.

- The "P" icon blinks.
- ① The scan pause timer and resume settings are the same as those for a normal scan. (p. 9-18)



Automatically selects the Priority channel.

When "Bell" is selected.

When a signal is received on the Priority channel, the display remains in the VFO mode.

- A beep sounds and the "(••)" icon blinks.



Remains in the VFO mode.

VFO scan and a Priority channel

Checks the selected Priority channel every 5 seconds, during a VFO mode scan.

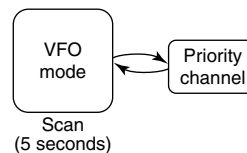

Step 1. Set the Priority channel

To select a Memory channel (p. 1-4)

1. Push [V/M] to enter the Memory mode.
2. Rotate [DIAL] to select the Memory channel you want to monitor.

To select a Bank channel (p. 1-9)

1. Push [V/M] to enter the Memory mode.
2. Push [QUICK].
3. Rotate [DIAL] to select "Bank Select," then push [↵].
4. Rotate [DIAL] to select the Bank channel you want to monitor.

To select a Call channel (p. 1-4)

1. Hold down [CALL] for 1 second to enter the Call channel mode.
2. Rotate [DIAL] to select the Call channel you want to monitor.

Step 2. Starts the Priority watch (p. 3-2)

1. Push [QUICK].
2. Rotate [DIAL] to select "PRIO Watch," then push [↵].
3. Select the Priority watch option, then push [↵].
 - "P" is displayed, and the Priority watch starts.

Step 3. Starts the VFO scan (p. 2-4)

1. In the VFO mode, hold down [SCAN] for 1 second.
 - Opens the Scan Type Select window.
2. Rotate [DIAL] to select a scan type, then push [↵].
 - The scan starts.

Example: Checks Memory channel "002" during a VFO mode scan.



Checks Memory channel "002" every 5 seconds.

Step 4. Canceling the Priority watch (p. 3-2)

1. Push [QUICK].
2. Rotate [DIAL] to select "PRIO Watch OFF," then push [↵].
 - "P" disappears, and the Priority watch is canceled.

◇ When a signal is received

When "ON" is selected.

When a signal is received on the Priority channel, the channel is automatically selected.

- The "P" icon blinks.
- ① The scan pause timer and resume settings are the same as those for a normal scan. (p. 9-18)



Automatically selects the Priority channel.

When "Bell" is selected.

When a signal is received on the Priority channel, the display remains in the VFO mode.

- A beep sounds and the "(•)" icon blinks.



Remains in the VFO mode.

VFO scan and a Memory/Bank scan

Sequentially checks the Memory or Bank channels every 5 seconds during a VFO mode scan. A Memory scan or Bank scan can be selected.

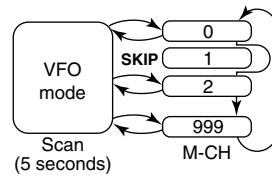

When using VFO scan and a Memory scan

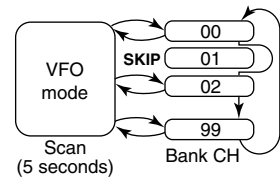

When using VFO scan and a Bank scan

Step 1. Start a Memory or Bank scan

To start a Memory scan (p. 2-6)

1. Push [V/M] to enter the Memory mode.
2. Hold down [SCAN] for 1 second.
 - Opens the Scan Type Select window.
3. Rotate [DIAL] to select a scan type, then push [↵].
 - The scan starts.

To start a Bank scan (p. 2-7)

1. Push [V/M] to enter the Memory mode.
2. Push [QUICK].
3. Rotate [DIAL] to select “Bank Select,” then push [↵].
4. Select a bank to be scanned, then push [↵].
5. Hold down [SCAN] for 1 second.
 - Opens the Scan Type Select window.
6. Rotate [DIAL] to select a scan type, then push [↵].
 - The scan starts.

Step 2. Starts the Priority watch (p. 3-2)

1. Push [QUICK].
2. Rotate [DIAL] to select “PRIO Watch,” then push [↵].
3. Select the Priority watch option, then push [↵].
 - “P” is displayed, and the Priority watch starts.

Step 3. Starts the VFO scan (p. 2-4)

1. In the VFO mode, hold down [SCAN] for 1 second.
 - Opens the Scan Type Select window.
2. Rotate [DIAL] to select a scan type, then push [↵].
 - The scan starts.

Example: Sequentially checks the Memory channels while VFO scanning.



Sequentially checks the Memory channels every 5 seconds.

Step 4. Canceling the Priority watch (p. 3-2)

1. Push [QUICK].
2. Rotate [DIAL] to select “PRIO Watch OFF,” then push [↵].
 - “P” disappears, and the Priority watch is canceled.

◇ When a signal is received

When “ON” is selected.

When a signal is received on the Priority channel, the channel is automatically selected.

- The “P” icon blinks.

① The scan pause timer and resume settings are the same as those for a normal scan. (p. 9-18)



Automatically selects the Priority channel.

When “Bell” is selected.

When a signal is received on the Priority channel, the display remains in the VFO mode.

- A beep sounds and the “((•))” icon blinks.



Remains in the VFO mode.

Scanning “FROM” on the DR screen and a Priority channel

Checks the selected Priority channel every 5 seconds, while receiving a repeater or simplex frequency in “FROM” of the DR screen.

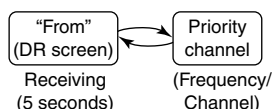

Step 1. Set the Priority channel

To set the VFO frequency

(See Basic manual section 3)

1. Push [V/M] several times until you enter the VFO mode.
2. Set the receive frequency and mode you want to monitor.

To select a Memory channel (p. 1-4)

1. Push [V/M] several times until you enter the Memory mode.
2. Rotate [DIAL] to select the Memory channel you want to monitor.

To select a Bank channel (p. 1-9)

1. Push [V/M] several times until you enter the Memory mode.
2. Push [QUICK].
3. Rotate [DIAL] to select “Bank Select,” then push [↵].
4. Rotate [DIAL] to select the Bank channel you want to monitor.

To select a Call channel (p. 1-4)

1. Hold down [CALL] for 1 second to enter the Call channel mode.
2. Rotate [DIAL] to select the Call channel you want to monitor.

Step 2. Select the repeater or simplex frequency in the DR screen (p. 4-3, D-STAR guide)

1. Hold down [DR] for 1 second to display the DR screen.
2. Select “FROM,” then push [↵].
 - Displays the FROM SELECT screen.
 - ① On the DR screen, pushing [DR] toggles between “FROM” and “TO.”
3. Rotate [DIAL] to select a repeater or a simplex frequency.

Step 3. Starts the Priority watch (p. 3-2)

1. Push [QUICK].
2. Rotate [DIAL] to select “PRIO Watch,” then push [↵].
3. Select the Priority watch option, then push [↵].
 - “P” is displayed, and the Priority watch starts.

Example: Checks Memory channel “002” every 5 seconds while receiving on a repeater frequency.

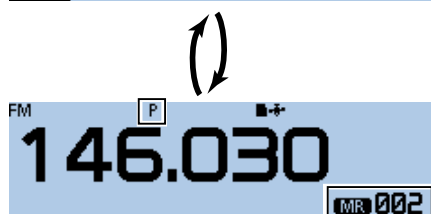
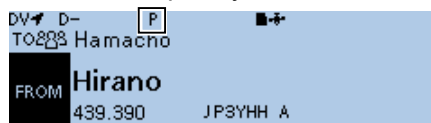

Checks Memory channel “002” every 5 seconds.

Step 4. Canceling the Priority watch (p. 3-2)

1. Push [QUICK].
2. Rotate [DIAL] to select “PRIO Watch OFF,” then push [↵].
 - “P” disappears, and the Priority watch is canceled.

◇ When a signal is received

When “ON” is selected.

When a signal is received on the Priority channel, the channel is automatically selected.

- The “P” icon blinks.
- ① The scan pause timer and resume settings are the same as those for a normal scan. (p. 9-18)



Automatically selects the Priority channel.

When “Bell” is selected.

When a signal is received on the Priority channel, the display remains on the DR screen.

- A beep sounds and the “(•)” icon blinks.

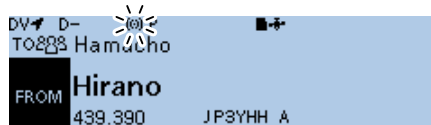

Remains on the DR screen.

DR scan and a Priority channel

Checks the selected Priority channel every 5 seconds, during a DR scan.

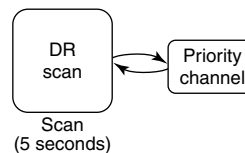

Step 1. Set the Priority channel

To set the VFO frequency

(See Basic manual section 3)

1. Push [V/M] several times until you enter the VFO mode.
2. Set the receive frequency and mode you want to monitor.

To select a Memory channel (p. 1-4)

1. Push [V/M] several times until you enter the Memory mode.
2. Rotate [DIAL] to select the Memory channel you want to monitor.

To select a Bank channel (p. 1-9)

1. Push [V/M] several times until you enter the Memory mode.
2. Push [QUICK].
3. Rotate [DIAL] to select "Bank Select," then push [↵].
4. Rotate [DIAL] to select the Bank channel you want to monitor.

To select a Call channel (p. 1-4)

1. Hold down [CALL] for 1 second to enter the Call channel mode.
2. Rotate [DIAL] to select the Call channel you want to monitor.

Step 2. Start the DR scan (p. 4-5)

1. Hold down [DR] for 1 second to display the DR screen.
2. Hold down [SCAN] for 1 second.
 - Displays the DR scan setting window.
3. Rotate [DIAL] to select the scan type, then push [↵].
 - The selected scan starts.

Step 3. Starts the Priority watch (p. 3-2)

1. Push [QUICK].
2. Rotate [DIAL] to select "PRIO Watch," then push [↵].
3. Select the Priority watch option, then push [↵].
 - "P" is displayed, and the Priority watch starts.

Example: Checks Memory channel "002" every 5 seconds during a DR scan.

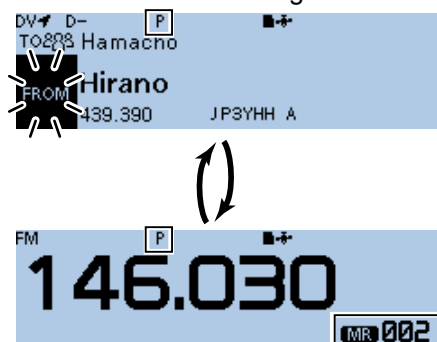

Checks Memory channel "002" every 5 seconds.

Step 4. Canceling the Priority watch (p. 3-2)

1. Push [QUICK].
2. Rotate [DIAL] to select "PRIO Watch OFF," then push [↵].
 - "P" disappears, and the Priority watch is canceled.

◇ When a signal is received

When "ON" is selected.

When a signal is received on the Priority channel, the channel is automatically selected.

- The "P" icon blinks.
- ① The scan pause timer and resume settings are the same as those for a normal scan. (p. 9-18)



Automatically selects the Priority channel.

When "Bell" is selected.

When a signal is received on the Priority channel, the display remains on the DR screen.

- A beep sounds and the "((•))" icon blinks.

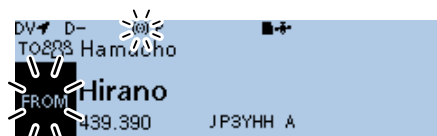

Remains on the DR screen.

“FROM” (Access repeater) setting.....	4-3
◇ Using your transceiver’s repeater list.....	4-4
◇ Using the DR scan.....	4-5
◇ Using the Near Repeater Search function.....	4-6
◇ Using the TX History.....	4-7
“TO” (Destination) setting.....	4-8
◇ Using the “Local CQ” (Local Area call).....	4-9
◇ Using the “Gateway CQ” (Gateway call).....	4-9
◇ Using “Your Call Sign”.....	4-10
◇ Using the RX History.....	4-10
◇ Using the TX History.....	4-11
◇ Directly entering (UR).....	4-11
◇ Directly entering (RPT).....	4-12
Connecting to a Reflector.....	4-13
◇ What is the reflector?.....	4-13
◇ Using a reflector.....	4-13
◇ Linking to a reflector.....	4-14
◇ Unlinking a reflector.....	4-15
◇ Reflector Echo Testing.....	4-15
◇ Requesting repeater information.....	4-16
Message operation.....	4-17
◇ Entering a TX message.....	4-17
◇ Transmitting a message.....	4-17
◇ TX message deleting.....	4-18
Viewing the received call signs.....	4-19
◇ View the call signs in the RX History screen.....	4-19
BK mode communication.....	4-21
EMR communication.....	4-22
◇ Adjusting the EMR AF level.....	4-22
Automatic DV detection.....	4-23
Automatic Reply function.....	4-24
◇ Recording an Auto Reply message.....	4-25
◇ Auto Position Reply function.....	4-26
Data communication.....	4-27
◇ Connection.....	4-27
◇ Data communication application setting.....	4-27
◇ Sending data.....	4-27
◇ DV Fast Data function.....	4-28
Digital squelch functions.....	4-29
◇ The digital call sign squelch setting.....	4-29
◇ Digital call sign squelch function with a Pocket beep ...	4-29
◇ The digital code squelch setting.....	4-30
◇ Digital code squelch function with a Pocket beep.....	4-30
Viewing call signs.....	4-31
Repeater list.....	4-32
◇ Repeater list contents.....	4-32
Entering new information into the Repeater List.....	4-33
◇ Required items for the communication cases.....	4-33
◇ Entering new information into the repeater list.....	4-34
Editing a repeater list.....	4-37
Deleting a repeater list.....	4-37
Rearranging the display order of the repeater.....	4-38
Adding the Repeater information using the RX History.....	4-39

 Continued on the next page

Skip setting for the DR scan 4-40
 ◇ Individual skip setting 4-40
 ◇ Group skip setting 4-40
Entering the repeater group name 4-41
Repeater detail screen 4-42
Entering Your (destination) call sign 4-43
Deleting Your (destination) call sign 4-44
Rearranging the display order of Your (destination) call signs . 4-45
Your setting is correct? 4-46

IMPORTANT!

- The repeater list, described in this manual, may differ from your transceiver’s preloaded contents.
- Although Japanese repeaters are used in the setting examples, the Japanese repeater node (port) letters are different from other country’s.

Be sure to add the repeater node letter in the 8th digit of the call sign, according to the frequency band shown below.

- 1200 MHz : A (B in Japan)
- 430 MHz : B (A in Japan)
- 144 MHz : C (no D-STAR repeaters in Japan)

To begin digital mode communication using other than the D-STAR Repeater (DR) function

To begin the digital mode communication using other than the DR function, you can use the VFO mode, Memory mode or Call channel mode.

This manual description focuses on the DR function operation which can be set up easily. If you want to use other than the DR function, see the procedures as described to the right, or select the repeater in a memory channel.

For a Local area call or Gateway call:

1. Set the access repeater’s frequency. (p. 8-2)
2. Set the Duplex direction. (p. 8-4)
3. Set the frequency offset for the Duplex operation. (p. 8-4)
4. Set the call signs (UR/R1/R2). (p. 9-41)

For a Simplex call:

1. Set the operating frequency.
2. Set the UR call sign (for call sign squelch). (p. 9-41)

“FROM” (Access repeater) setting

Your access repeater must be set in “FROM” when you make a call on the DR screen.
 You have five ways to set the access repeater.

Setting by [DIAL]

Select the preset repeater by rotating [DIAL] on the DR screen.

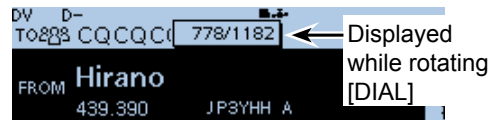

• When you know your access repeater

From the repeater list (p. 4-4)

You can select your access repeater from the repeater list by selecting the repeater area and name, if entered, or call sign.



• When you do not know which repeater you can access.

Search for a repeater using the DR scan (p. 4-5)

The Normal DR scan searches for output repeater frequencies of nearby repeaters. The scan will stop when a signal is detected.

- The scan will also stop on simplex signals.

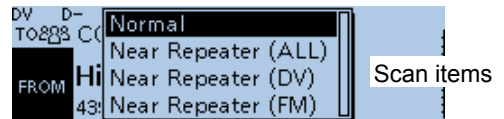

The Near Repeater scan searches for output repeater frequencies of nearby repeaters that are within 160 kilometer (99.4 miles) from your location and the repeater’s location that is entered in the Repeater List. The DR scan starts scanning and will stop when a signal is detected.
 You can also find only FM repeaters using the Near Repeater (FM) scan.

Search for near repeaters (p. 4-6)

Searches for near repeaters that are within 160 kilometer (99.4 miles) from your location using your GPS location and the repeater’s location that is entered in the Repeater List.

The nearest repeaters in your transceiver’s Repeater List are displayed as selectable choices.

You can select the nearby DV only, FM only, or both repeater types.

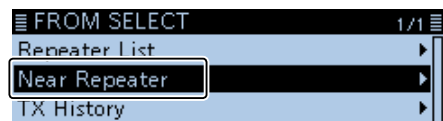

• When the “FROM” data is saved in the TX History.

Setting from the TX History (p. 4-7)

Select a repeater that you have accessed before from the TX History record.



“FROM” (Access repeater) setting (Continued)

◇ **Using your transceiver’s repeater list**

When your access repeater is in your transceiver’s repeater list, you can select it from the list. By only selecting the repeater from the list, the call sign, frequency, duplex and offset frequency settings are automatically set for easy operation.

Example: Selecting the “Hirano” repeater in Japan from the repeater list.

1. Hold down [DR] for 1 second to display the DR screen.
2. Select “FROM,” then push [↵].
 - Displays the FROM SELECT screen.
 - ① On the DR screen, pushing [DR] toggles between “FROM” and “TO.”
3. Rotate [DIAL] to select “Repeater List,” then push [↵].



• Displays the REPEATER GROUP screen.

4. Select the repeater group where your access repeater is listed, then push [↵]. (Example: “11: Japan”)

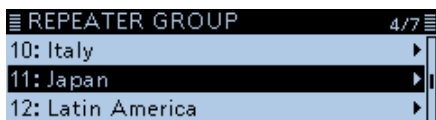

5. Select your access repeater, then push [↵]. (Example: “Hirano”)



• Returns to the DR screen, and the selected repeater name is displayed in “FROM.”

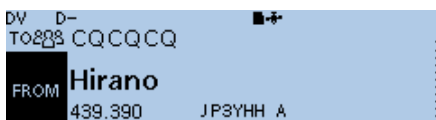

- ① The repeater list, described in this manual, may differ from your transceiver’s preloaded contents.

TIP:
When you select an FM repeater:
 When an FM repeater is in your transceiver’s repeater list, you can select it from the list. When selecting an FM repeater, the “TO” setting is not necessary and a “---” is displayed in “TO.”

When selecting an FM repeater.

(Sample)

How to change the repeater group:
 To change the repeater group on the DR screen, push [QUICK], then select “Group Select.”

“FROM” (Access repeater) setting (Continued)

◇ Using the DR scan

The DR scan scans frequencies to find a signal on a repeater or a simplex frequency. You can use two kinds of DR scans, Normal scan and Near Repeater scan.

Normal scan

To quickly find a repeater, the Normal scan skips repeaters that are not specified as an access repeater. (The “USE (FROM)” setting is set to “NO” (SKIP is set) on the repeater list.)

Near Repeater scan

The Near Repeater scan searches for up to 20 nearby repeaters by using your location and the repeater’s entered location, and then lists the repeaters.

- ① The Near Repeater scan will continue, even if you turn OFF the power, and then turn it ON again during the scan.
- ① If your own position is not being received, the last received position is used.

NOTE: Even if your transceiver receives a repeater signal, the repeater may not receive your signal, because the repeater’s output power is higher than your transceiver’s, and your signal doesn’t reach the repeater.

TIP: The DR scan scans the simplex frequencies in the repeater list, in addition to a D-STAR repeaters.

Example: Selecting the “HamFair” repeater in Japan using the DR scan.

1. Hold down [DR] for 1 second to display the DR screen.
2. Hold down [SCAN] for 1 second.
 - Displays the DR scan setting window.

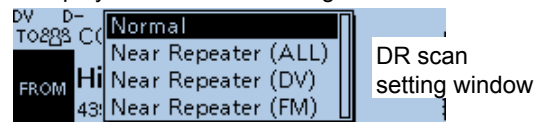

3. Rotate [DIAL] to select the scan type.
 - Normal: Searches for repeaters whose “USE (FROM)” setting is set to “YES.”
 - Near Repeater (ALL): Searches for up to 20 nearby DV or FM repeaters. (Total 40 repeaters)
 - Near Repeater (DV): Searches for up to 20 nearby DV repeaters.
 - Near Repeater (FM): Searches for up to 20 nearby FM repeaters.
4. Push [↵].
 - The selected scan starts.

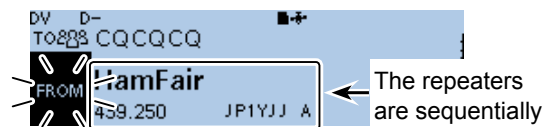

While DR scanning

- ① While DR scanning, the repeaters are sequentially displayed.
 - ① The scan resumes the same as other scans. (p. 9-18)
5. When the transceiver receives a signal from a repeater, the scan stops.

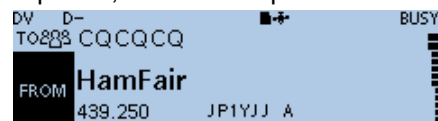

6. Push [SCAN].
 - The DR scan is canceled, and the repeater is set to “FROM.”

“FROM” (Access repeater) setting (Continued)

◇ Using the Near Repeater Search function

The transceiver searches for the nearest repeater by using your location and the repeater’s entered position.
The nearest repeater in your transceiver’s repeater list is displayed as the available choices.

NOTE:

- When using the Repeater Search function, be sure to first receive your own position data, or manually enter your position data.
- If no repeater is found within a 160 kilometer range, “No Repeater Found” will be displayed.
- If the last received position can be used, “GPS is invalid. Search by last valid position” will be displayed.

Example: Selecting the “Icom Repeater” in Japan from the Near Repeater list.

Step 1: Receiving your own position from the GPS satellite

① When it is difficult to receive signals indoors, even if you are near a window, try going outdoors for better reception.

Confirm the GPS receiver is receiving your position.

- The GPS icon blinks when searching for satellites.

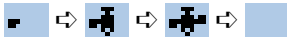

- The GPS icon stops blinking when the minimum needed number of satellites is found.



- ① It may take only a few seconds to receive, or it may take a few minutes, depending on your operating environment.
- ① If your own position is not being received, the last received position is used.

Step 2: Selecting the access repeater from the Near Repeater list

1. Hold down [DR] for 1 second to display the DR screen.
2. Select “FROM,” then push [↵].
 - Displays the FROM SELECT screen.
 - ① On the DR screen, pushing [DR] toggles between “FROM” and “TO.”
3. Select “Near Repeater,” then push [↵].

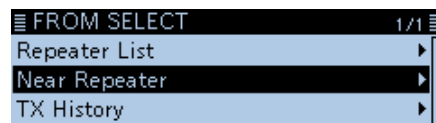

- Displays the NEAR REPEATER screen.
4. Select the type of nearby repeater to display, then push [↵].

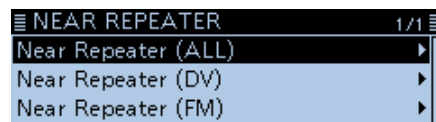

- Near Repeater (ALL): Displays up to 20 nearby DV and FM repeaters. (A total 40 repeaters)
 - Near Repeater (DV): Displays up to 20 nearby DV repeaters.
 - Near Repeater (FM): Displays up to 20 nearby FM repeaters.
5. Select the repeater to select it as your access repeater, considering the distance from your position to the repeater, then push [↵]. (Example: “Icom Repeater”)



Repeater call sign.

Displayed for FM repeaters

Distance and direction from your position to the repeater*

- Returns to the DR screen, and the selected repeater is set in “FROM.”

*When the position data accuracy level is set to “Approximate,” the direction data is not displayed if the distance to the repeater is less than 5 kilometers. (p. 4-36)

“FROM” (Access repeater) setting (Continued)

◇ Using the TX History

Repeaters you transmitted on before are saved in the TX History. You can select a repeater from the TX History as your access repeater.

The TX History saves up to 10 of the latest “FROM” (Access) repeaters.

Example: Selecting the “Hirano” repeater in Japan from the TX History.

1. Hold down [DR] for 1 second to display the DR screen.
2. Select “FROM,” then push [↵].
 - Displays the FROM SELECT screen.
 - ① On the DR screen, pushing [DR] toggles between “FROM” and “TO.”
3. Rotate [DIAL] to select “TX History,” then push [↵].



• Displays the TX HISTORY screen.

4. Select the TX history, then push [↵].

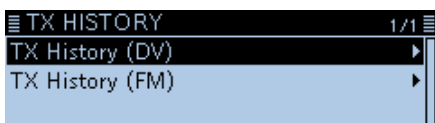

• TX History (DV): Displays the TX history of the DV repeaters.

• TX History (FM): Displays the TX history of the FM repeaters.

5. Select the repeater to use as your access repeater, then push [↵]. (Example: “Hirano”)

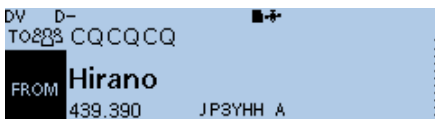
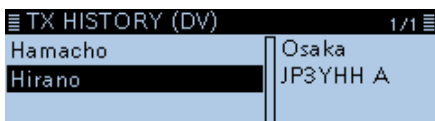

• Returns to the DR screen, and the selected repeater is set in “FROM.”

TIP: When you push [QUICK] in step 5, you can display the REPEATER DETAIL screen, or delete the repeater information from the TX HISTORY screen.

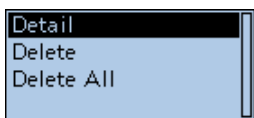

“TO” (Destination) setting

The destination repeater or station must be set in “TO” when you make a call in the DV mode. You have eight ways to set the destination.

TIP: After you receive the individual station or repeater’s signal, the call sign can be captured by holding down the Call Sign Capture key ([RX→CS]), and you can quickly and easily reply to a call.

Setting by rotating [DIAL]

Rotate [DIAL] to select the repeater or Your Call Sign that is displayed on the DR screen. (This operation is disabled when “CQCQCQ” is set.)

To make a Local Area CQ call

“Local CQ” setting (p. 4-9)
Set “CQCQCQ” in “TO” (Destination).

To make a Gateway CQ call

“Gateway CQ” setting (p. 4-9)
Select a repeater from the repeater list, if you want to make a Gateway call.

To make a call to a specific station

“Your Call Sign” setting (p. 4-10)
Select the station call sign in the Your Call Sign memory.

To make a call through a reflector

“Reflector” setting (p. 4-12)
Select a reflector you want to call through.

To select from RX History

Setting from RX History (p. 4-10)
When you receive a call, the repeater or caller station data is saved in RX History. You can select the destination from the record.

To select from TX History

Setting from TX History (p. 4-11)
When you make a call, the destination repeater or called station data is saved in TX History. You can select the destination from the record.

To directly enter the destination station call sign

Direct Input (UR) (p. 4-11)
Directly enter the destination station’s call sign.

To directly enter the destination repeater call sign

Direct Input (RPT) (p. 4-12)
Directly enter the destination repeater’s call sign.

TO SELECT screen

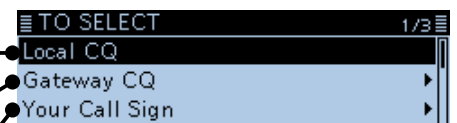

TIP: How to change the repeater group:
When “Local CQ” or “Gateway CQ” is selected, you can change the repeater group. To change the repeater group on the DR screen, push [QUICK], then select “Group Select.”

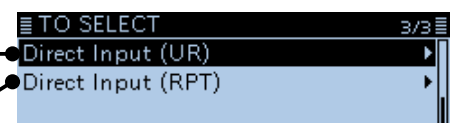

“TO” (Destination) setting (Continued)

◇ Using the “Local CQ” (Local Area call)

When “Local CQ” is selected on the TO SELECT screen, “CQCQCQ” is set in “TO.”

Example: Making a Local area call by accessing the “Hirano” repeater.

1. Hold down [DR] for 1 second to display the DR screen.
2. Select “TO,” then push [↵].

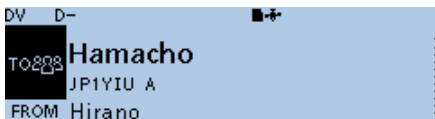

- Displays the TO SELECT screen.
- ① On the DR screen, pushing [DR] toggles between “FROM” and “TO.”

3. Select “Local CQ,” then push [↵].

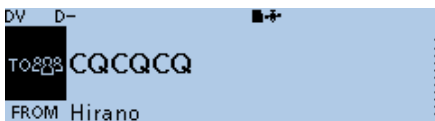

- Returns to the DR screen, and “CQCQCQ” is displayed in “TO.”

◇ Using the “Gateway CQ” (Gateway call)

When “Gateway CQ” is selected on the TO SELECT screen, you can select the repeater to make a gateway call on the repeater list.

Example: Making a Gateway CQ call to the “Hamacho” (Japan) repeater from the “Hirano” repeater.

1. Hold down [DR] for 1 second to display the DR screen.
2. Select “TO,” then push [↵].

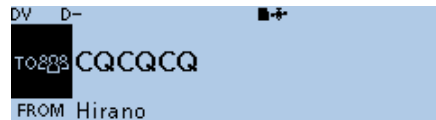

- Displays the TO SELECT screen.
- ① On the DR screen, pushing [DR] toggles between “FROM” and “TO.”

3. Select “Gateway CQ,” then push [↵].



- Displays the REPEATER GROUP screen.
4. Select the repeater group where your destination repeater is listed, then push [↵]. (Example: “11: Japan”)
 5. Select the destination repeater, then push [↵]. (Example: “Hamacho”)

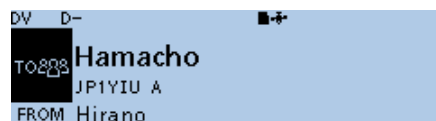

- Returns to the DR screen, and “Hamacho” is displayed in “TO.”

TIP: After selecting a destination repeater, you can select another repeater preset in your repeater list by rotating [DIAL].



“TO” (Destination) setting (Continued)

◇ Using “Your Call Sign”

The “Your Call Sign” memory saves the “UR” (destination) call signs. When you select an individual station call sign for the “TO” (Destination) setting using “Your Call Sign,” you can make a Gateway call. When you call the destination through a gateway, the signal is automatically sent to the last repeater that the station accessed. So, even if you do not know where the station is, you can make a call.

NOTE: If the repeater, set in “FROM” (Access Repeater) has no Gateway call sign, you cannot make a gateway call.

Example: Selecting “Station1” from the “Your Call Sign.”

1. Hold down [DR] for 1 second to display the DR screen.
2. Select “TO,” then push [↵].



- Displays the TO SELECT screen.
- ① On the DR screen, pushing [DR] toggles between “FROM” and “TO.”

3. Select “Your Call Sign,” then push [↵].



- Displays the YOUR CALL SIGN screen.

4. Select the destination name or call sign, then push [↵]. (Example: Station1)

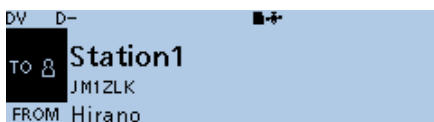
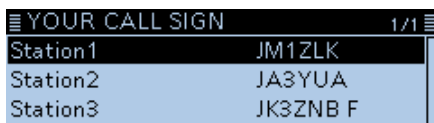

- Returns to the DR screen, and “Station1” is displayed in “TO.”

TIP: After selecting a destination, you can select another station preset in your transceiver by rotating [DIAL].

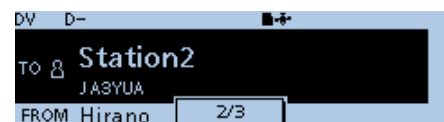

◇ Using the RX History

When a call is received in the DV mode, the call data is saved in the RX History.

Up to 50 Callers, and only the last Called call signs can be saved.

Example: Selecting “Station1” in the RX History.

1. Hold down [DR] for 1 second to display the DR screen.
2. Select “TO,” then push [↵].

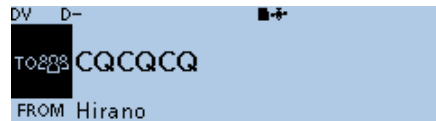

- Displays the TO SELECT screen.
- ① On the DR screen, pushing [DR] toggles between “FROM” and “TO.”

3. Select “RX History,” then push [↵].



- Displays the RX HISTORY screen.

4. Select the destination name or call sign, then push [↵]. (Example: Station1)

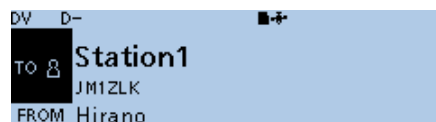

- Returns to the DR screen, and “Station1” is displayed in “TO.”

TIP: To add the RX HISTORY data to memory, push [QUICK], then select “Add To Your Memory.”

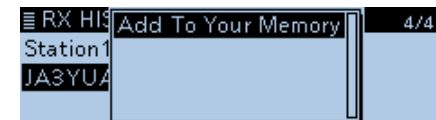

“TO” (Destination) setting (Continued)

◇ Using the TX History

The TX History saves the name and/or call sign of up to 20 “TO” (Destination) settings that were used when you made the calls.

NOTE: Until you make a call in the DV mode, you cannot select “TO” (destination) from the TX History.

Example: Selecting the “Hamacho” repeater in the TX History.

1. Hold down [DR] for 1 second to display the DR screen.
2. Select “TO,” then push [↵].

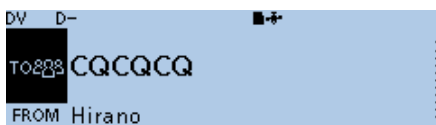

- Displays the TO SELECT screen.
- ① On the DR screen, pushing [DR] toggles between “FROM” and “TO.”

3. Select “TX History,” then push [↵].



- Displays the TX HISTORY screen.
4. Select the destination name or call sign, then push [↵]. (Example: “Hamacho”)



The Sub name is displayed.

- Returns to the DR screen, and “Hamacho” is displayed in “TO.”



TIP: You can add the TX HISTORY data to memory, or delete it from the TX HISTORY screen, push [QUICK], then select the option.

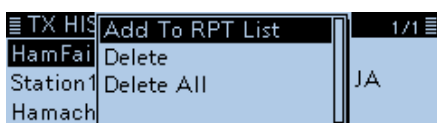

◇ Directly entering (UR)

The destination station call sign can be directly entered.

Example: Directly entering the call sign “JM1ZLK.”

1. Hold down [DR] for 1 second to display the DR screen.
2. Select “TO,” then push [↵].

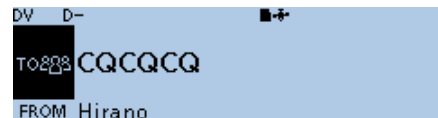

- Displays the TO SELECT screen.
- ① On the DR screen, pushing [DR] toggles between “FROM” and “TO.”

3. Select “Direct Input (UR),” then push [↵].

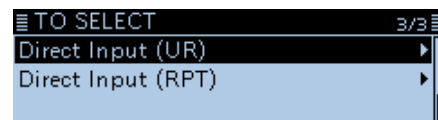

- Displays the DIRECT INPUT (UR) screen.

4. Enter a call sign of up to 8 characters, including spaces.

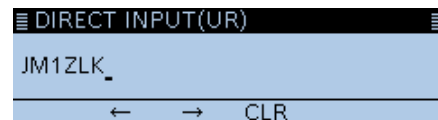

- ① See “Entering and editing text” for details. (p. iv)
5. After entering, push [↵].
- Returns to the DR screen, and “JM1ZLK” is displayed in “TO.”
 - ① After entry, you can correct the call sign in the DIRECT INPUT (UR) screen.
 - ① The entered call sign remains on the DIRECT INPUT (UR) screen, until you enter a new call sign.

TIP: If the entered call sign is duplicated in “Your Call Sign” memory, the name is displayed. (Only when the name has been entered.)

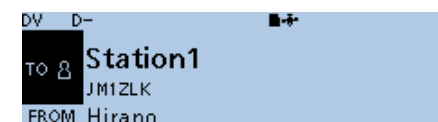

“TO” (Destination) setting (Continued)

◇ **Directly entering (RPT)**

The destination repeater call sign can be directly entered.

Example: Directly entering the call sign “JP1YIU”

1. Hold down [DR] for 1 second to display the DR screen.
2. Select “TO,” then push [↵].

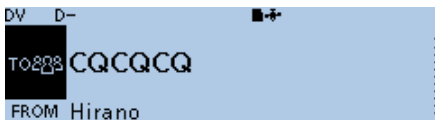

- Displays the TO SELECT screen.
- ① On the DR screen, pushing [DR] toggles between “FROM” and “TO.”

3. Select “Direct Input (RPT),” then push [↵].

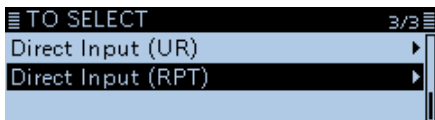

- Displays the DIRECT INPUT (RPT) screen.

4. Enter a call sign of up to 8 characters, including spaces.

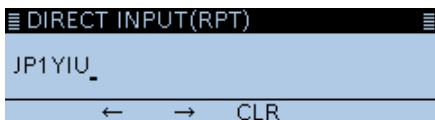

- ① See “Entering and editing text” for details. (p. iv)

5. After entering, push [↵].
 - Returns to the DR screen, and “JP1YIU” is displayed in “TO.”
 - ① After entry, you can correct the call sign in the DIRECT INPUT (RPT) screen.
 - ① The entered call sign remains on the DIRECT INPUT (RPT) screen, until you enter a new call sign.

TIP:

- If the entered call sign is duplicated in the repeater list, the name is displayed. (Only when the name has been entered.)



- When “/” is entered, the repeater call sign can be used for a Gateway call.

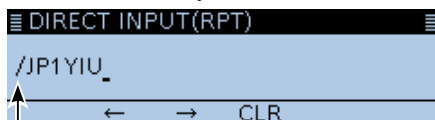

“/” is entered.

Connecting to a Reflector

◇ What is the reflector?

A reflector is a special server connected to the Internet and running a version of dplus software. If the dplus software is installed on your access repeater, it provides various functions including gateway and reflector linking capabilities (It is known as the D-STAR reflector system). The D-STAR reflector system enables a number of D-STAR repeaters anywhere to link to a reflector. This means that when you transmit through a D-STAR repeater linked to a reflector, your voice can be heard on other repeaters linked to the reflector, and you can hear other stations that are connected to the reflector.

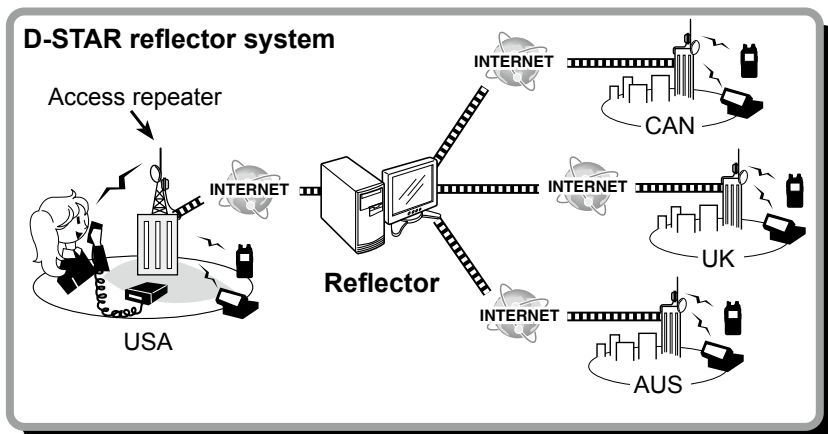

◇ Using a reflector

1. Hold down [DR] for 1 second to display the DR screen.
2. Select "TO," then push [↵].
 - Displays the TO SELECT screen.
 - ① On the DR screen, pushing [DR] toggles between "FROM" and "TO."
3. Rotate [DIAL] to select "Reflector," then push [↵].
 - Displays the REFLECTOR screen.

4. Select "Use Reflector," then push [↵].

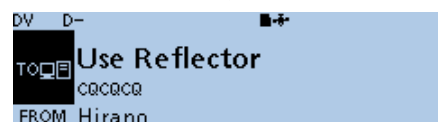
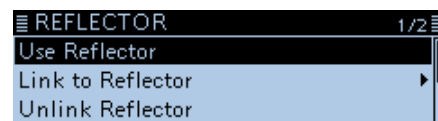

5. Hold down [PTT] to transmit.
 - Returns to the DR screen, and "Use Reflector" and "CQCQCQ" are displayed in "TO."
 - Displays [TX] while transmitting.

Connecting to a Reflector (Continued)

◇ Linking to a reflector

If your repeater is not currently linked to a reflector, or you want to change to another reflector, you can do so following the steps below. Before linking to a reflector, be sure to unlink any current reflector. (p. 4-15)

Direct entering a reflector

Example: Directly entering "REF010BL."

1. Hold down [DR] for 1 second to display the DR screen.
2. Select "TO," then push [↵].
 - Displays the TO SELECT screen.
 - ① On the DR screen, pushing [DR] toggles between "FROM" and "TO."
3. Rotate [DIAL] to select "Reflector," then push [↵].
 - Displays the REFLECTOR screen.
4. Select "Link to Reflector," then push [↵].
 - Displays the "Link to Reflector" screen.
5. Select "Direct Input," then push [↵].
6. Rotate [DIAL] to select the reflector number. (Example: 010)

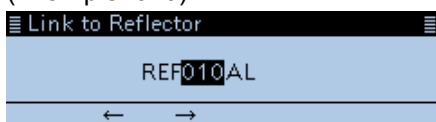

7. Push [MW](→) to move the cursor to the right box.
8. Rotate [DIAL] to select the module letter. (Example: B)

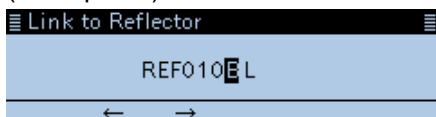

9. Push [↵].
 - Returns to the DR screen, and "Link to Reflector" and "REF010BL" are displayed in "TO."

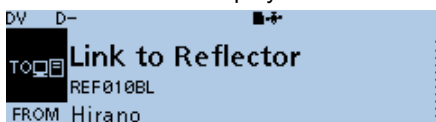

10. Hold down [PTT] to link to the reflector.
 - Displays **T X** while transmitting.

Using the TX History

The TX History saves the up to 5 reflectors that your access repeater linked before.

Example: Selecting the "REF010BL" in the TX History.

1. Hold down [DR] for 1 second to display the DR screen.
2. Select "TO," then push [↵].
 - Displays the TO SELECT screen.
 - ① On the DR screen, pushing [DR] toggles between "FROM" and "TO."
3. Rotate [DIAL] to select "Reflector," then push [↵].
 - Displays the REFLECTOR screen.
4. Select "Link to Reflector," then push [↵].
 - Displays the "Link to Reflector" screen.
5. Select the reflector that you want to link to. (Example: "REF010BL")

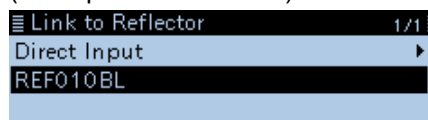

- Returns to the DR screen, and "Link to Reflector" and "REF010BL" are displayed in "TO."
6. Hold down [PTT] to link to the reflector.
 - Displays **T X** while transmitting.

Connecting to a Reflector (Continued)

◇ **Unlinking a reflector**

Before trying to link to another reflector, be sure to unlink the current connected reflector.

1. Hold down [DR] for 1 second to display the DR screen.
2. Select "TO," then push [↵].
 - Displays the TO SELECT screen.
 - ① On the DR screen, pushing [DR] toggles between "FROM" and "TO."
3. Rotate [DIAL] to select "Reflector," then push [↵].
 - Displays the REFLECTOR screen.
4. Select "Unlink Reflector," then push [↵].

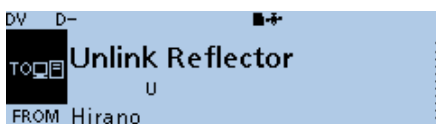
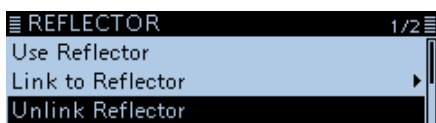

- Returns to the DR screen, and "Unlink Reflector" and "U" are displayed in "TO."

5. Hold down [PTT] to unlink the reflector.
 - Displays **T x** while transmitting.

◇ **Reflector Echo Testing**

You can transmit a short message, and after releasing [PTT], your message will be played back. It is a useful check of how well your signal is getting into the repeater, and you can use it to verify that your repeater is operating normally.

1. Hold down [DR] for 1 second to display the DR screen.
2. Select "TO," then push [↵].
 - Displays the TO SELECT screen.
 - ① On the DR screen, pushing [DR] toggles between "FROM" and "TO."
3. Rotate [DIAL] to select "Reflector," then push [↵].
 - Displays the REFLECTOR screen.
4. Select "Echo Test," then push [↵].

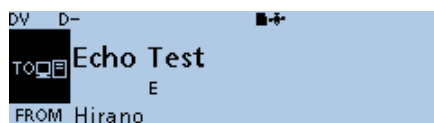
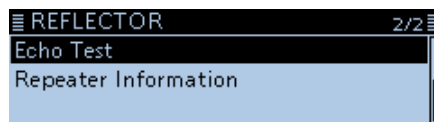

- Returns to the DR screen, and "Echo Test" and "E" are displayed in "TO."

5. Hold down [PTT] and speak into the microphone.
 - Displays **T x** while transmitting.
6. Release [PTT] to hear your message.

Connecting to a Reflector (Continued)

◇ Requesting repeater information

When you send the repeater information command, an ID message is sent back.

1. Hold down [DR] for 1 second to display the DR screen.
2. Select "TO," then push [↵].
 - Displays the TO SELECT screen.
 - ① On the DR screen, pushing [DR] toggles between "FROM" and "TO."
3. Rotate [DIAL] to select "Reflector," then push [↵].
 - Displays the REFLECTOR screen.
4. Select "Repeater Information," then push [↵].

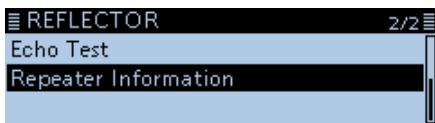

- Returns to the DR screen, and "Repeater Information" and "I" are displayed in "TO."
5. Hold down [PTT] to send the repeater information command.
 - Displays **T X** while transmitting.
 6. Release [PTT] to hear the repeater ID message.

Message operation

You can save up to 5 short messages in memory, to transmit in the DV mode.

Each message can be up to 20 characters long.

◇ Entering a TX message

Example: Entering “JAPAN TOM” into message memory number 1.

My Station > TX Message

1. Push [MENU].
2. Rotate [DIAL] to select “My Station,” then push [↵].



3. Select “TX Message,” then push [↵].

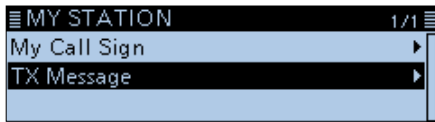

• Displays the TX MESSAGE screen.

4. Select a message memory number, then push [QUICK].
5. Select “Edit,” then push [↵].



• Enters the TX Message entry mode.

6. Enter a message of up to 20 characters. (Example: JAPAN TOM)

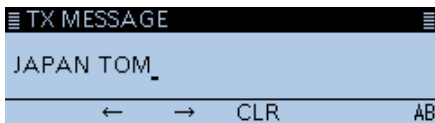

Selectable characters and symbols

A to Z, a to z, 0 to 9, ! " # \$ % & ' () * + , - . / : ; < = > ? @ [\] ^ _ ` { | } ~ (space)

① See “Entering and editing text” for details. (p. iv)

7. After entering, push [↵].
- Returns to the TX MESSAGE screen.

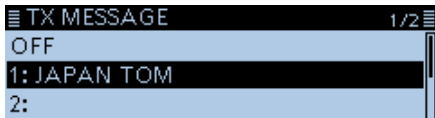

8. Push [MENU].
- Returns to the standby screen.”

◇ Transmitting a message

You can transmit a pre-entered text message by pushing [PTT]. First, select a TX message which also turns ON the Message Transmission function.

My Station > TX Message

1. Push [MENU].
 2. Rotate [DIAL] to select “My Station,” then push [↵].
 3. Select “TX Message,” then push [↵].
- Displays the TX MESSAGE screen.
4. Select a message memory, then push [↵]. (Example: 1: JAPAN TOM)

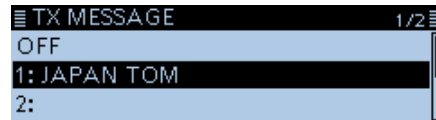

① To not transmit any message, select “OFF.”

5. Push [MENU].
- Returns to the standby screen.”

① Information

- The message is transmitted each time you push [PTT].
- The message is transmitted along with your voice signal.

TIP: RX call sign and message display

As the default, the received call sign and message are automatically displayed and scrolled on the LCD. To not display and scroll them, set “RX Call Sign” to “OFF.”

(Display > RX Call Sign)

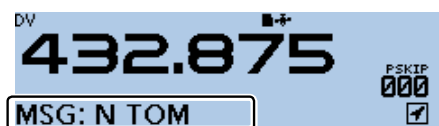
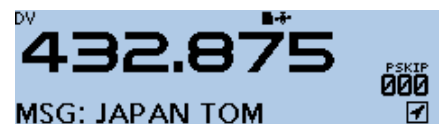

Scrolls

4 D-STAR OPERATION

Message operation (Continued)

◇ Deleting a TX message

You can delete the entered TX message.

Example: Deleting the entered TX message “JAPAN TOM” from message memory number 1.

My Station > TX Message

1. Push [MENU].
2. Rotate [DIAL] to select “My Station,” then push [↵].



3. Select “TX Message,” then push [↵].

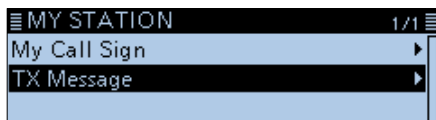

• Displays the TX MESSAGE screen.

4. Select a message memory number to delete, then push [QUICK].
5. Select “Clear,” then push [↵].



• The confirmation dialog “Clear?” is displayed.

6. Select <YES>, then push [↵].

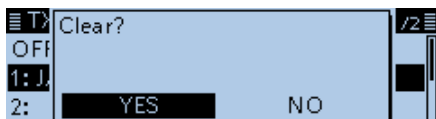

• Clears the entered message.

7. Push [MENU].
• Returns to the standby screen.”

Viewing the received call signs

When you receive a DV call, the calling station and the repeater's call signs are saved. Up to 50 calls can be saved. Even if the transceiver is turned OFF, the RX record is not deleted. When you receive the 51th call, the oldest history will be deleted.

◆ View the call signs in the RX History screen

1. Push [QUICK].
2. Rotate [DIAL] to select "RX History," then push [↵].

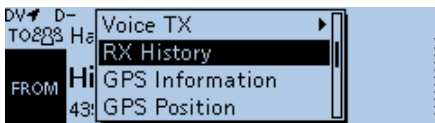

- Displays the RX HISTORY screen.
3. Rotate [DIAL] to select an RX history memory.

① Information

- The RX history number, the caller's name (or call sign), destination, RX message, RX date and time, "GW," and "GPS" are displayed on the screen.
 - "GW" is displayed when the Gateway call is received.
 - "GPS" is displayed when the received call includes the position data.
 - "UP" is displayed when the repeater uplink signal is received.
 - Hold down [RX→CS] for 1 second to temporary set the received call sign to the "TO" field (destination).
4. Push [↵].
 - Displays the RX history detail screen.

5. Rotate [DIAL].
 - Selects the page.

<First page>

- CALLER: Displays the caller station's name*2 and any note entered after the call sign.
- CALLED: Displays the called station's name*2.

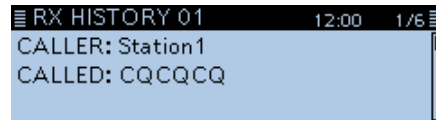

<Second page>

- RXRPT1: Displays the repeater's name*2 that was accessed by the caller station. If it was a call through a gateway and the internet, this item displays the gateway call sign of the repeater you received the call from.
 - Rx RPT2: Displays the repeater's name*2 you received the call from.
- ① "FREQUENCY" is displayed instead of above items when the call was not through a repeater (Simplex call), to show the frequency that was used.

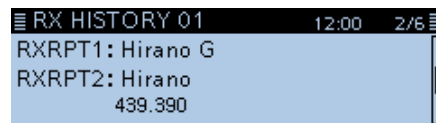

<Third page>

- RX MESSAGE: Displays any message included in the received call, if entered.
- RX TIME: Displays the date and time the call was received.

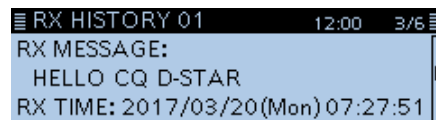

RX HISTORY screen (RX01)

Displayed when a Gateway call is received.

Received date and time

D-PRS TX format icon*1

History number → RX01: 2017/03/20 7:27

Station1 → CQCQCQ

HELLO CQ D-STAR

Caller station*2

① A note may be displayed after "/".

RX message

Called station ("CQCQCQ" is displayed if you received a CQ call.)

First page

*1 The displayed icon differs, depending on the D-PRS TX format.

GPS: Position OBJ: Object
ITEM: Item WX: Weather

*2 When a name is not entered in the memory, call sign is displayed. You can change the display type between "Name Display" and "Call Sign Display" in the Quick menu window. (Default: Name Display)

4 D-STAR OPERATION

Viewing the received call signs

- ◇ View the call signs in the RX History screen (Continued)

<Fourth page>, <Fifth page>, <Sixth page>

Displays the position data of the caller station. If a received signal has no data, then no position data is displayed.

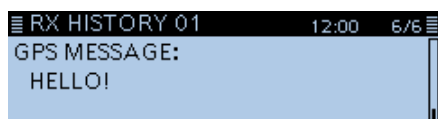
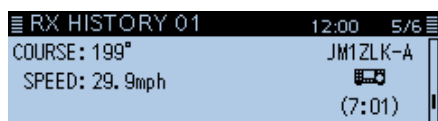
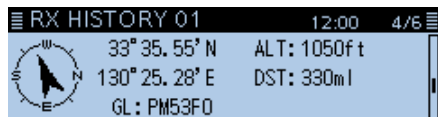

6. Push [MENU].
 - Returns to the standby screen.

TIP: To delete the RX HISTORY data

On the RX HISTORY or the detail screen, push [QUICK], then select "Delete."

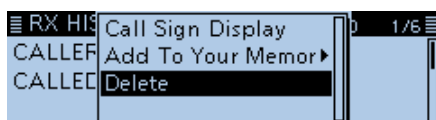

TIP: "RX RPT1" setting may differ, depending on the way the call was made.

Example: When a Local area call is received.

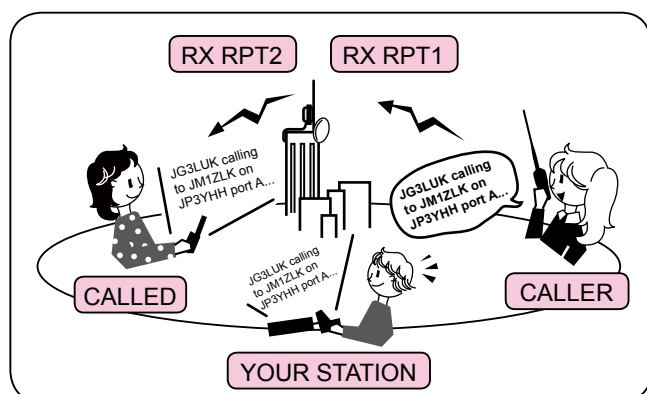

Example: When a Gateway call is received.

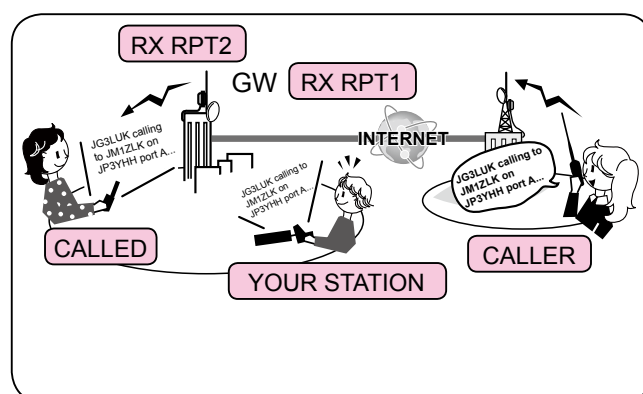

BK mode communication

The BK (Break-in) function enables you to break into a conversation, where the two other stations are communicating with call sign squelch enabled. (Default: OFF)

- ① The BK function is automatically turned OFF when transceiver is turned OFF.

DV Set > BK

- While two other stations are communicating in the DV mode, hold down [RX→CS] for 1 second.
 - The calling station's call sign is set to "TO" (Destination).
 - ① When a call sign is not received correctly, error beeps sound, and no call sign is set.
 - ① After releasing, beeps sound and the calling station's call sign is announced. (RX→CS Speech function)
- Push [MENU].
- Rotate [DIAL] to select "DV Set," then push [↵].



- Select "BK," then push [↵].

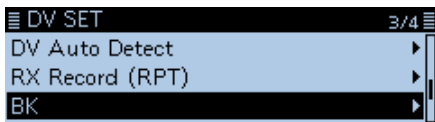

- Select "ON," then push [↵].



- Push [MENU].
 - Returns to the standby screen, and "BK" is displayed.

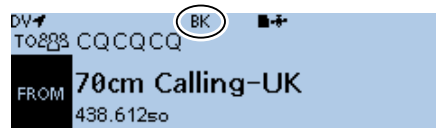

- When both stations are in standby, push [PTT] to transmit.
 - Displays **T X** while transmitting.
 - ① "BK" blinks when receiving the Break-in call.
 - ① To cancel the BK mode, select "OFF" in step 5, or turn OFF the transceiver.

How to use Break-in?

While using digital call sign squelch, the squelch never opens (no audio is heard) even if a call is received, unless your own call sign is specified.

However, when a call including the "BK ON" signal (break-in call) is received, the squelch will open and audio is heard even if the call is specified for another station.

Station C calling to Station A with "BK OFF"

Station A and B are communicating using digital call sign squelch.

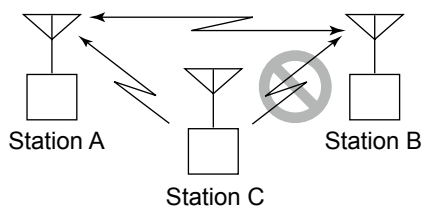

Station B never hears that Station C is calling Station A.

Station C calling to Station A with "BK ON"

Station A and B are communicating using digital call sign squelch.

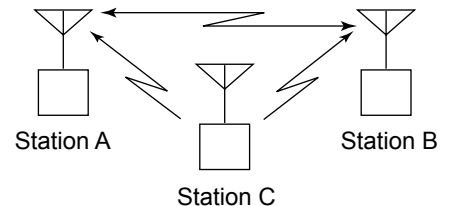

Station B also hears that Station C is calling Station A.

EMR communication

The EMR (Enhanced Monitor Request) communication function can be used in only the DV mode. Using the EMR function, no call sign setting is necessary.

All transceivers that receive an EMR signal automatically open their squelch to receive the signal. When an EMR signal is received, the audio (voice) will be heard at the specified level, even if the volume setting level is set to the minimum level, or the digital call sign/digital code squelch is used. (Default: OFF)

① The EMR communication function is automatically turned OFF when the transceiver is turned OFF.

Example: Transmitting from the “Hirano” repeater using the EMR function.

DV Set > EMR

1. Push [MENU].
2. Rotate [DIAL] to select “DV Set,” then push [↵].



3. Select “EMR,” then push [↵].



4. Select “ON,” then push [↵].



5. Push [MENU].
 - Returns to the standby screen, and “EMR” is displayed.

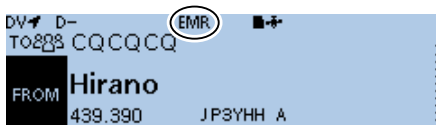

6. Push [PTT] to transmit.
 - Displays **TX** while transmitting.
 - ① “EMR” blinks on a station that receives the EMR signal. The audio (voice) will be heard at the specified level, or the [VOL] control level, whichever is higher.
 - ① To cancel the EMR mode, select “OFF” in step 4, or turn OFF the transceiver.

◇ Adjusting the EMR AF level

The audio output level when an EMR signal is received is adjustable between 0 and 32.

When an EMR signal is received, the audio will be heard at the preset level, or the [VOL] control level, whichever is higher.

To disable the setting, set it to “0.”

DV Set > EMR AF Level

1. Push [MENU].
2. Rotate [DIAL] to select “DV Set,” then push [↵].
3. Select “EMR AF Level,” then push [↵].



4. Rotate [DIAL] to adjust the EMR audio output level between 0 (minimum) and 32 (maximum) in single digit steps. (Default: 19)

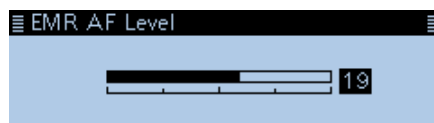

5. Push [MENU].
 - Returns to the standby screen.

Automatic DV detection

If you receive an FM signal while in the DV mode, the “DV” and “FM” icons alternately blink to indicate the received signal is FM.

When the DV Auto Detect function is turned ON, the transceiver automatically selects the FM mode to temporarily monitor the signal. (Default: OFF)

① Regardless of this setting, the “DV” and “FM” icons alternately blink if you receive an FM signal while in the DV mode.

TIP: When digital call sign squelch (DSQL) or digital code squelch (CSQL) is set, the transceiver does not receive FM signals, even if this function is ON. You can silently wait for calls from others.

DV Set > DV Auto Detect

1. Push [MENU].
2. Rotate [DIAL] to select “DV Set,” then push [↵].



3. Select “DV Auto Detect,” then push [↵].

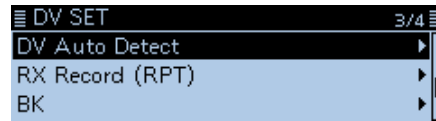

4. Select “ON,” then push [↵].

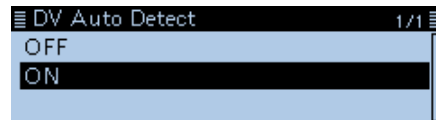

5. Push [MENU].
 - Returns to the standby screen.
 - ① When an FM signal is received while in the DV mode, the “DV” and “FM” icons sequentially blink, and the transceiver receives the signal in the FM mode.

When an FM signal is received while in the DV mode

DV Auto Detect function: OFF

The “DV” and “FM” icons alternately blink, but the audio cannot be heard.

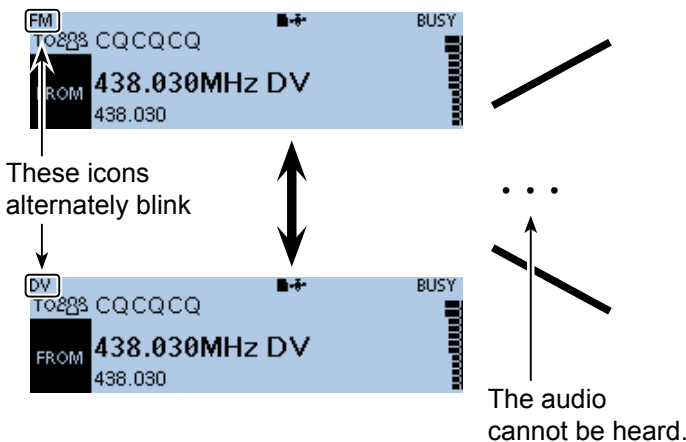

DV Auto Detect function: ON

The “DV” and “FM” icons alternately blink, and the audio can be heard.

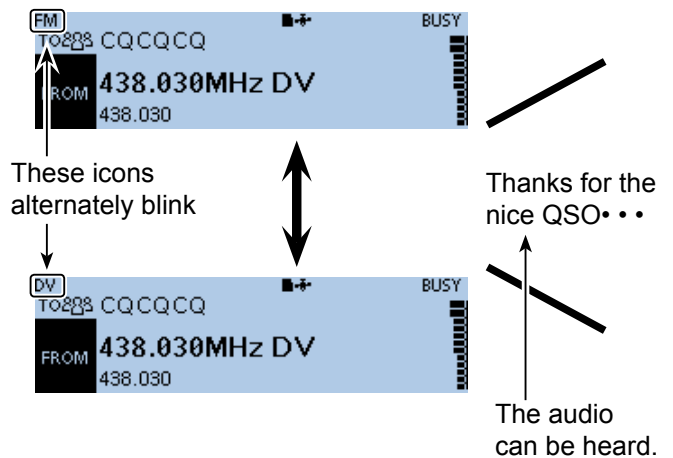

Automatic Reply function

When a call addressed to your own call sign is received, the Automatic Reply function automatically replies with your call sign. (Default: OFF)
Depending on the setting, a recorded message may be transmitted with the call sign.

NOTE: The Automatic Reply function temporary sets the received call sign to the destination call sign.

TIP: To record the Auto Reply message

You can record the Auto Reply message. See page 9-22 for details.
(Voice Memo > DV Auto Reply)

DV Set > Auto Reply

1. Push [MENU].
2. Rotate [DIAL] to select "DV Set," then push [↵].
3. Select "Auto Reply," then push [↵].



4. Select an option.



- ON: Automatically replies with your own call sign. (No audio reply is sent)
- Voice: Automatically replies with your call sign and an Auto Reply message recorded on the microSD card (up to 10 seconds).
 - ① If no card is inserted, or no message is recorded, replies with your own call sign. (No audio reply is sent)
- Position: Automatically replies with your own call sign and your position data using the internal or external GPS receiver.
 - ① When "GPS Select" is set to "OFF" or "Manual," the internal GPS receiver is temporarily turned ON. When "GPS Select" is set to "External GPS," but if the external GPS receiver is not connected, the internal GPS receiver is temporarily turned ON.

5. Push [MENU].
 - Returns to the standby screen, and displays "RPT."

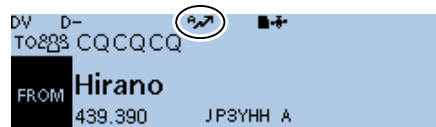

- ① When "ON" or "Voice" is selected, the Automatic Reply function is automatically turned OFF, when you push [PTT].
When "Position" is selected, the Automatic Reply function remains ON, when you push [PTT].

Example: After receiving a call from "JM1ZLK," the transceiver automatically sends a reply call.

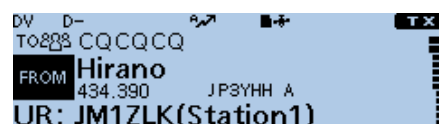

The "TO" setting does not change, but "UR: JM1ZLK (Caller's call sign)" is displayed.

4 D-STAR OPERATION

Automatic Reply function (Continued)

◇ Recording an Auto Reply message

You can record the Auto Reply message and saved on a microSD card to reply to the call with your voice.

TIP: Be sure a microSD card is in the card slot.

Voice Memo > DV Auto Reply

1. Push [MENU].
2. Rotate [DIAL] to select "Voice Memo," then push [↵].



3. Select "DV Auto Reply," then push [↵].

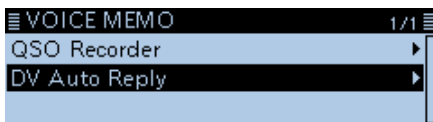

4. Push [MW].
 - Starts recording.



- ① Maximum record time is 10 second
 - ① Hold the microphone 5 to 10 cm (2 to 4 inches) from your mouth, then speak at a normal voice level.
 - ① Only one message can be recorded. The current contents will be overwritten if you record again.
5. Push [MENU].
 - Returns to the standby screen.

TIP:

- To delete the recorded message, push [QUICK] on the DV AUTO REPLY screen, then select "Clear."



- To record message with the optional VS-3 Bluetooth HEADSET, push [V/M] on the DV AUTO REPLY screen, then select "Bluetooth MIC."

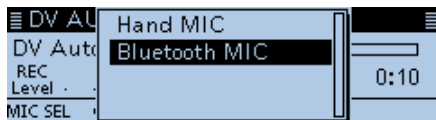

DV AUTO REPLY screen operation

[MENU]
Returns to the standby screen

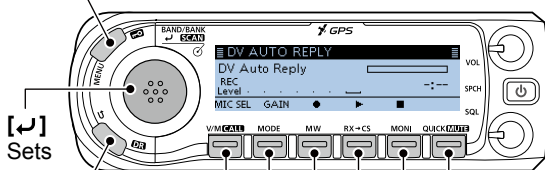

[↵]
Sets

[S]
Returns to the VOICE MEMO screen

[V/M]
Selects the microphone

[MODE]
Adjusts the microphone gain

[QUICK]
Clears the recorded message

[MONI]
Stops recording

[RX→CS]
Starts the playback

[MW]
Starts recording

- Push [MONI] to stop recording.
- Push [RX→CS] to start the playback.
- Push [MODE] to display the microphone gain adjustment bar.



Audio level is displayed

Adjust the Mic gain so that the REC Level does not reach to this range

Automatic Reply function (Continued)

◆ Auto Position Reply function

When you receive a call addressed to your own call sign, but are in a situation that makes it difficult to operate the transceiver, this function automatically replies with your own call sign and transmits your position data.

After receiving the Auto Position Reply call, the caller's position data is displayed in a window.

- ① Only the Icom transceivers, ID-4100A/E, ID-5100A/E, ID-51A/E PLUS, or ID-51A/E PLUS2, displays the position after receiving a call. (As of April 2017)
- ① You can turn OFF the caller's position indication. (Display > **RX Position Display**) (p. 9-63)

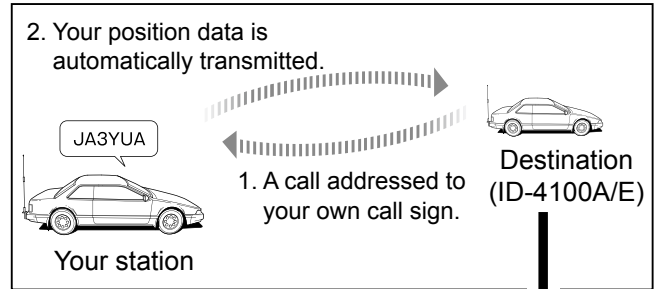

- 3. After receiving, the position data is displayed in the destination's window.

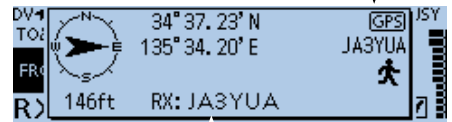

Scrolls your call sign or the TX message.
 ① Your status message may be displayed.

When no valid position data is received

After receiving a call addressed to your own call sign, the internal GPS receiver is temporarily turned ON for approximately 5 minutes to receive your position data, even if "GPS Select" is set to "OFF," "External GPS," or "Manual." Then, the transceiver automatically replies with a message, as described below.

- ① When the internal GPS receiver is temporarily ON, and valid position data is received, the transceiver transmits your position data if a call addressed to your own call sign is received again.

Reply message list when no valid position data is received

Message	Status
No Position	When no position is received.
Old Position	2 minutes or more has passed since receiving position data.
No Posi & GPS Start	The internal GPS receiver is temporarily turned ON, but has not received your position data yet.
Old Posi & GPS Start	The internal GPS receiver is temporarily turned ON, and 2 minutes or more have passed since receiving the position data.



Scrolls your message

TIP:

- The position data is transmitted according to the GPS TX mode. (p. 9-24)
- When the GPS TX mode settings are incorrect for the Automatic Reply function, the transceiver automatically corrects them to reply to a call.
- When the GPS transmission mode is OFF, "D-PRS" is automatically selected.

Data communication

In addition to digital voice communication, you can send and receive data. And you can use the DV Fast Data function for data communication.

The DV Fast Data function uses the data and the audio frames to send data approximately 3.5 times faster than the normal speed. So, no audio can be sent. To send and receive data, the optional OPC-2350LU and a data communication software (user supplied) are required.

NOTE: Before starting data communication
 “DV Data TX” is set to “Auto” as the default setting. So, when you enter text data into your communication software, the transceiver may automatically transmit it, depending on the software and the software settings.

◇ Connection

Connect the transceiver to your PC using the optional OPC-2350LU, as shown below.

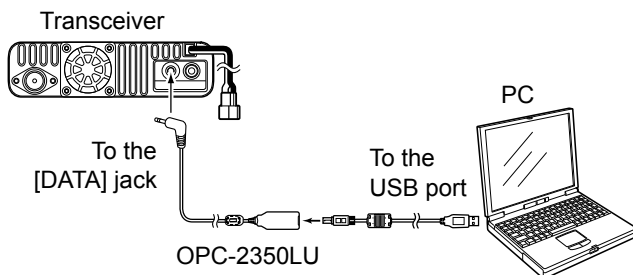

NOTE: Before you start sending data, be sure to set the following items. (p. 9-24)

- Set “GPS SELECT” to other than “External GPS.”
 (GPS > GPS Set > **GPS Select**)
- Set “GPS OUT (To DATA Jack)” to “OFF.”
 (GPS > GPS Set > **GPS Out (To DATA Jack)**)
- When “GPS TX Mode” is “D-PRS,” set “TX Format” to other than “Weather.”
 (GPS > GPS TX Mode > D-PRS > **TX Format**)

◇ Data communication application setting

Set the communication software, as shown below.

- Port: The COM port number that is used by the ID-4100A/E.*1
- Baud rate: 4800/9600 bps*2
- Data: 8 bit
- Parity: none
- Stop: 1 bit
- Flow control: Xon/Xoff

*1 Depending on the PC environment, the COM port number used by the ID-4100A/E may be higher than 5. In that case, use an application that can set it to higher than 5.

*2 Set the baud rate in “Data Speed.” (p. 9-60)
 (Function > **Data Speed**)

◇ Sending data

1. Set your own call sign, the UR call sign and the repeater call sign.
2. Follow the instructions of your data communication application software.
3. When you enter text data into your communication software, the transceiver may automatically transmit it, depending on the software and the software settings.
 - ① When “DV Data TX” is set to “PTT,” pushing [PTT] transmits the text data and a voice signal. (p. 9-48) (DV Set > DV Data TX)
 - ② Before transmission, the transceiver sends approximately 500 milliseconds of carrier sense.

NOTE:

- Only the ASCII code can be used for data communication.
- The standard Message Transmission function also transmits up to 20 characters. (pp. 4-17, 4-18)
- Depending on the combination of your PC and your communication software, some data may be lost.
- While receiving voice or data through the internet, some packets may be lost due to network error (poor data throughput performance). In such a case, an “L” is displayed on the screen to indicate that packet loss has occurred.

Data communication (Continued)

◇ DV Fast Data function

To send data using the DV Fast Data function, do the following.

- ① The DV Fast Data communication can be made by only the following Icom transceivers: ID-4100A/E, ID-5100A/E*, or ID-51A/E (PLUS, PLUS2, 50th Anniversary model). (As of April 2017)

*Usable only when firmware versions CPU M 1.10, S 1.00, C 1.10, and DSP 1.10 or later are installed.

NOTE: When using DV Fast Data function, if you want to send GPS data to other transceivers that can receive only slow speed data, set “GPS Data Speed” to “Slow.” (p. 9-49)
(DV Set > DV Fast Data > **GPS Data Speed**)

TIP: The DV Fast Data function can also be used when you operating the transceiver through the RS-MS1A or RS-MS1I REMOTE CONTROL SOFTWARE.
① The optional UT-137 Bluetooth UNIT is required.

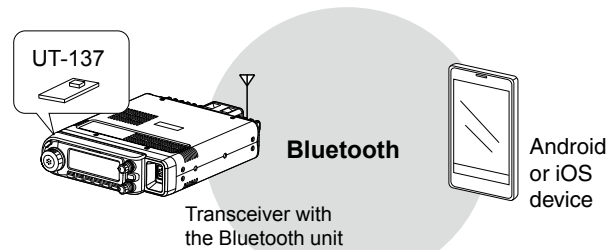

DV Set > DV Fast Data > **Fast Data**

1. Push [MENU].
2. Rotate [DIAL] to select “DV Set,” then push [↵].



3. Select “DV Fast Data,” then push [↵].

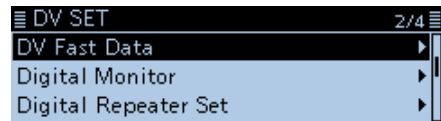

4. Select “Fast Data,” then push [↵].

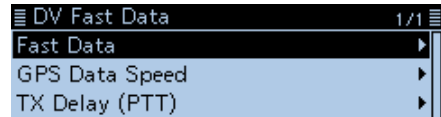

5. Select “ON,” then push [↵].



6. Push [MENU].
 - Returns to the standby screen.

Digital squelch functions

The digital squelch opens only when you receive a signal addressed to your own call sign, or a signal that includes a matching digital code.

You can silently wait for calls from others.

You can independently set the Digital squelch function in the VFO mode, Memory mode, CALL channel mode, or DR function.

◇ The digital call sign squelch setting

1. Push [QUICK].
2. Rotate [DIAL] to select "DSQL," then push [↵].

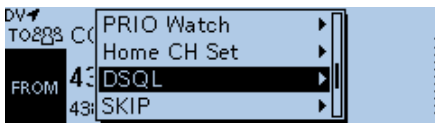

3. Select "DSQL ((·))" or "DSQL," then push [↵].

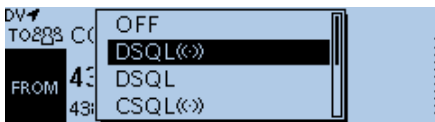

- DSQL ((·)) : Turns ON the digital call sign squelch function with the Pocket beep.
 - ① "DSQL ((·))" is displayed.
- DSQL: Turns ON the digital call sign squelch function.
 - ① "DSQL" is displayed.

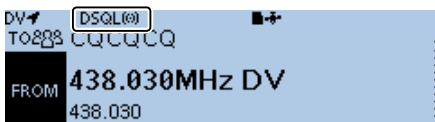

When the received signal includes a matching call sign, the squelch opens and you can hear the audio.

- ① When the received signal does not include a matching call sign, the digital call sign squelch does not open. However, the S/Rf meter displays the received signal level.

◇ Digital call sign squelch function with a Pocket beep

When a received signal is addressed to your own call sign, the beeps sound for 30 seconds and an "((·))" blinks. Within 30 seconds, push [PTT] to answer, or operate the transceiver to stop the beeps and turn OFF the Pocket beep function.

- "((·))" disappears.

- ① If you make no operation for 30 seconds, the beeps automatically stop, but "((·))" continues to blink to indicate that you received a call.

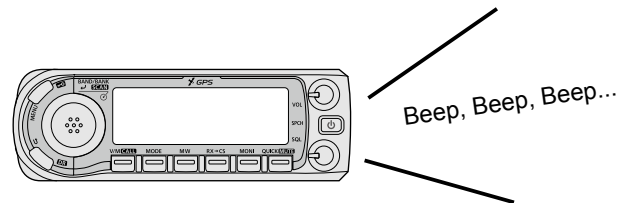

NOTE:

- **DO NOT** use the digital call sign squelch function when communicating with two or more stations, because the digital call sign squelch function opens only when receiving a signal addressed to your own call sign. Thus the digital call sign squelch function can be used when communicating with only one station.
- Even if the squelch closes by the digital call sign squelch function, you can receive data in the DV mode.

Digital squelch functions (Continued)

◇ The digital code squelch setting

1. Push [QUICK].
2. Rotate [DIAL] to select “DSQL,” then push [↵].

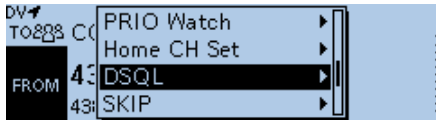

3. Select “CSQL ((·))” or “CSQL,” then push [↵].
 - CSQL ((·)) : Turns ON the digital code squelch function with the Pocket beep.
 - ① “CSQL ((·))” is displayed.
 - CSQL: Turns ON the digital code squelch function.
 - ① “CSQL” is displayed.

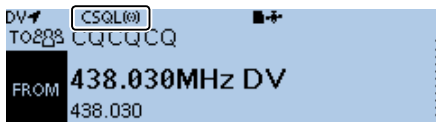
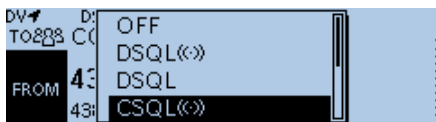

4. Push [MENU].
5. Select “DUP/TONE...,” then push [↵].

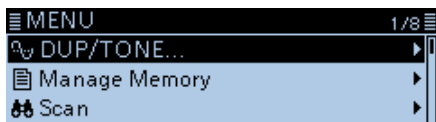

6. Select “Digital Code,” then push [↵].



7. Rotate [DIAL] to select the digital code.



8. Push [MENU].
 - Returns to the standby screen.

When the received signal includes a matching code, the squelch opens and you can hear the audio.

- ① When the received signal does not include a matching code, the digital code squelch does not open. However, the S/Rf meter displays the signal level.

◇ Digital code squelch function with a Pocket beep

When a received signal matches your digital code, beeps sound for 30 seconds and an “((·))” blinks. Within 30 seconds, push [PTT] to answer, or operate the transceiver to stop the beeps and turn OFF the Pocket beep function.

- “((·))” disappears.
- ① If you make no operation for 30 seconds, the beeps automatically stop, but “((·))” continues to blink to indicate that you received a call.

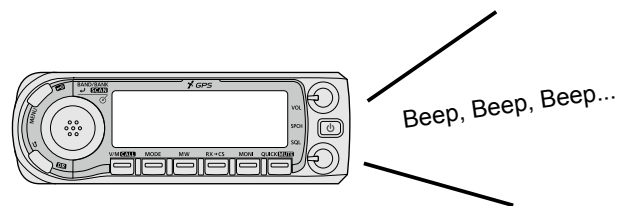

NOTE: Even if the squelch closes by the digital code squelch function, you can receive data in the DV mode.

Viewing call signs

While in the DV mode, you can display the CALL SIGN screen.

1. Push [MENU].
2. Rotate [DIAL] to select "Call Sign," then push [↵].



- Displays the CALL SIGN screen.
3. Push [MENU].
 - Returns to the standby screen.

CALL SIGN screen

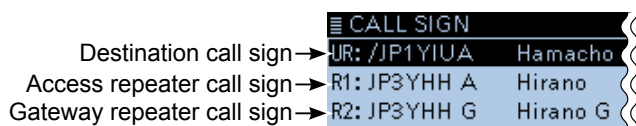

Repeater list

You can save repeater information for quick and simple communication in up to 1500 repeater memory channels (Repeater list) in up to 50 Groups. Entering data into the repeater list is required to use the DR function.

You can enter four types of frequencies into the repeater list, as shown below:

- DV repeater
- DV simplex
- FM repeater
- FM simplex

TIP:

- For easy operation, the repeater list is preloaded into your transceiver. However, if you do an All Reset, the CPU clears all the setting data, the memory channels, and the repeater list. We recommend that you back up the memory data to a microSD card or save it to a PC using the CS-4100 cloning software.
- The repeater list can be downloaded from the Icom website.
<http://www.icom.co.jp/world/support/download/firm/index.html>

◇ Repeater list contents

The following contents are included in the repeater list:

- TYPE: Frequency type (p. 4-34)
- NAME: Repeater name (p. 4-34)
- SUB NAME: Repeater sub name (p. 4-34)
- CALL SIGN: Repeater call sign and port letter (p. 4-34)
- GW CALL SIGN: Gateway repeater's call sign and port "G" (p. 4-34)
- GROUP: Repeater group (p. 4-35)
- USE(FROM): Access repeater use (p. 4-35)
- FREQUENCY: Access repeater's frequency (p. 4-35)
- DUP: Duplex direction (p. 4-35)
- OFFSET FREQ: Frequency offset (p. 4-35)
- MODE: Operating mode (p. 4-35)
- TONE: Tone setting (p. 4-35)
- REPEATER TONE: Repeater tone (p. 4-35)
- POSITION: Position data accuracy level (p. 4-36)
- LATITUDE: Latitude of the repeater (p. 4-36)
- LONGITUDE: Longitude of the repeater (p. 4-36)
- UTC OFFSET: UTC Offset (p. 4-36)

Example: "Hamacho" repeater information

```

≡ REPEATER LIST 1/5 ≡
TYPE      : DV Repeater
NAME      : Hamacho
SUB NAME  : Tokyo
    
```

```

≡ REPEATER LIST 2/5 ≡
CALL SIGN : JP1YIU A
GW CALL SIGN : JP1YIU G
GROUP     : 11 Japan
    
```

```

≡ REPEATER LIST 3/5 ≡
USE(FROM) : YES
FREQUENCY : 434.400.00
DUP       : DUP+
    
```

```

≡ REPEATER LIST 4/5 ≡
OFFSET FREQ : 5.000.00
POSITION    : Approximate
LATITUDE    : 35°41.19'N
    
```

```

≡ REPEATER LIST 5/5 ≡
LONGITUDE   : 139°47.46'E
UTC OFFSET  : +9:00
    
```

Entering new information into the Repeater List

This section describes how to manually enter new repeater information into the repeater list. The required setting items differ, depending on your communication usage. Confirm the required items, as shown below.

DR screen



NOTE: To enter repeater information into the repeater list, the repeater's call sign **MUST** be entered first.

◇ Required items for the communication cases

Repeater list contents	Used as an access repeater	Used as a destination repeater	Used for DV simplex	Used as an FM repeater	Used for FM simplex
TYPE	DV Repeater	DV Repeater	DV Simplex	FM Repeater	FM Simplex
NAME	○	○	○	○	○
SUB NAME	○	○	○	○	○
CALL SIGN	●	●	N/A	○	N/A
GW CALL SIGN	● (For a Gateway call)	●	N/A	N/A	N/A
GROUP	○	○	○	○	○
USE(FROM)	●	○	●	●	●
FREQUENCY	●	○	●	●	●
DUP	●	○	N/A	●	N/A
OFFSET FREQ	●	○	N/A	●	N/A
MODE	N/A	N/A	N/A	○	○
TONE	N/A	N/A	N/A	○	○
REPEATER TONE	N/A	N/A	N/A	○	○
POSITION	○	○	○	○	○
LATITUDE	○	○	○	○	○
LONGITUDE	○	○	○	○	○
UTC OFFSET	○	○	○	○	○

●: Must be entered
 ○: Possible to enter
 N/A: Not Applicable

Entering new information into the Repeater List (Continued)

◇ Entering new information into the repeater list

Step 1. Selecting the repeater group

DV Memory > Repeater List

1. Push [MENU].
2. Rotate [DIAL] to select "DV Memory," then push [↵].



3. Select "Repeater List," then push [↵].

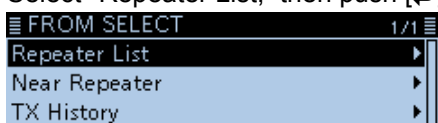

4. Select a repeater group to add a repeater to, then push [↵].

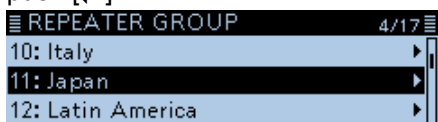

(Example: 11: Japan)

- Displays the repeater list of the selected repeater group.

5. Push [QUICK].
6. Select "Add," then push [↵].

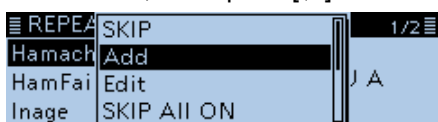

- The REPEATER LIST EDIT screen is displayed.

Step 2. Selecting the communication type

1. Select "TYPE," then push [↵].
2. Select the communication type, then push [↵].
 - DV Repeater: Repeater operation in the DV mode.
 - DV Simplex: Simplex operation in the DV mode.
 - FM Repeater: Repeater operation in the FM mode.
 - FM Simplex: Simplex operation in the FM mode.

Step 3. Entering the repeater name

1. Select "NAME," then push [↵].
 - Enters the repeater name entry mode.
2. Enter a name of up to 16 characters.

Selectable characters and symbols
A to Z, a to z, 0 to 9, ! " # \$ % & ' () * + , - . / : ; < = > ? @ [\] ^ _ ` { } ~ (space)

① See "Entering and editing text" for details. (p. iv)

3. After entering, push [↵].

Step 4. Entering the repeater sub name

1. Select "SUB NAME," then push [↵].
 - Enters the repeater sub name entry mode.
2. Enter a sub name of up to 8 characters.
3. After entering, push [↵].

Step 5. Entering the repeater call sign

① When 'Step 2. Selecting the communication type' is set to "DV Simplex" or "FM Simplex," go to 'Step 7. Changing the repeater group.'

1. Select "CALL SIGN," then push [↵].
 - Enters the repeater call sign entry mode.
2. Enter the repeater call sign of up to 8 characters, including spaces.
3. After entering, push [↵].

TIP: Be sure to add the repeater node letter in the 8th digit of the call sign, according to the frequency band shown below. Note that there are almost always different node letters between Japanese D-STAR repeaters and repeaters in other countries. Cross band operation between different nodes at the same repeater site can be made.

- 1200 MHz: A (B in Japan)
- 430 MHz: B (A in Japan)
- 144 MHz: C (no D-STAR repeaters in Japan)

Step 6. Entering the gateway repeater call sign

- ① This item is displayed when 'Step 2. Selecting the communication type' is set to "DV Repeater."
- ① The 8th digit in the call sign, entered in 'Step 5. Entering the repeater call sign,' is automatically set to "G" as the gateway port, so you can skip this setting and go to the next item. To change it, follow the steps, described below.
 1. Select "GW CALL SIGN," then push [↵].
 - Enters the gateway repeater call sign entry mode.
 2. Enter a gateway repeater call sign of up to 8 characters, including spaces.
 - ① A space or "G" can be entered in the 8th digit.
 3. After entering, push [↵].

Entering new information into the Repeater List

◇ Entering new information into the repeater list (Continued)

Step 7. Changing the repeater group

① The repeater group that is selected in 'Step 1. Selecting the repeater group' is displayed. You can skip this setting and go to the next item. To change the group, follow the steps, described below.

1. Select "GROUP," then push [↵].
 - Enters the repeater group selection mode.
2. Select the repeater group, 01 to 50, then push [↵].

Step 8. Setting "USE(FROM)" to be used as an Access repeater

① You can use the entered repeaters as an access repeater when using the DR function. When not using as an access repeater, select "NO," and go to '15. Selecting the position data accuracy level.' In that case, the entered repeater is not displayed in the "FROM" field.

1. Select "USE(FROM)," then push [↵].
2. Select "YES" to use the repeater as an access repeater, then push [↵].

Step 9. Entering the access repeater frequency

1. Select "FREQUENCY," then push [↵].
 - Enters the frequency entry mode.
2. Rotate [DIAL] to enter the repeater frequency, then push [↵].
 - ① Push [MW] to move the cursor forwards, or push [MODE] to move the cursor backwards to select a digit to enter.

Step 10. Selecting the duplex direction

① When 'Step 2. Selecting the communication type' is set to "DV Simplex" or "FM Simplex," this item is not displayed.

- ① "DUP-" is automatically set when the access repeater frequency is entered in 'Step 9. Entering the access repeater frequency.'
- ① If necessary, you can change the duplex direction.

1. Select "DUP," then push [↵].
2. Select a duplex direction, then push [↵].
 - OFF: Turn the duplex function OFF.
 - DUP-: The transmit frequency shifts down from the receive frequency by the offset amount.
 - DUP+: The transmit frequency shifts up from the receive frequency by the offset amount.

Step 11. Entering the frequency offset

① When 'Step 2. Selecting the communication type' is set to "DV Simplex" or "FM Simplex," this item is not displayed.

① The offset value* is automatically set when the access repeater frequency is entered in 'Step 9. Entering the access repeater frequency.'

*The default value differs, depending on the transceiver version.

① If necessary, you can change the frequency offset.

1. Select "OFFSET FREQ," then push [↵].
 - Enters the frequency offset entry mode.
2. Rotate [DIAL] to enter the frequency offset between 0.000.00 ~ 59.995.00 MHz, then push [↵].
 - ① Push [MW] to move the cursor forwards, or push [MODE] to move the cursor backwards to select a digit to enter.

Step 12. Setting the FM mode

① When 'Step 2. Selecting the communication type' is set to "DV Repeater" or "DV Simplex," this item is not displayed.

1. Select "MODE," then push [↵].
 - Enters the operating mode setting mode.
2. Select "FM" or "FM-N," then push [↵].

Step 13. Setting the tone

① When 'Step 2. Selecting the communication type' is set to "DV Repeater" or "DV Simplex," this item is not displayed.

1. Select "TONE," then push [↵].
 - Enters the tone setting mode.
2. Select the option, then push [↵].
 - OFF: Turn the tone function OFF.
 - TONE: Select when the repeater requires an access tone.
 - TSQL: Select when you want to use the tone squelch operation in simplex.

Step 14. Selecting the repeater tone frequency

① When 'Step 2. Selecting the communication type' is set to "DV Repeater" or "DV Simplex," this item is not displayed.

① This setting is required when 'Step 13. Setting the tone' is set to "TONE" or "TSQL."

1. Select "REPEATER TONE," then push [↵].
 - Enters the repeater tone setting mode.
2. Rotate [DIAL] to select the repeater tone frequency, then push [↵].

Entering new information into the Repeater List

◇ Entering new information into the repeater list (Continued)

Step 15. Selecting the position data accuracy level

- ① When the Near Repeater Search function is not used, or the distance between your position and a repeater is not displayed, select “OFF,” and go to ‘Step 18. Setting the UTC offset.’
1. Select “POSITION,” then push [↵].
 2. Select the position data accuracy level, then push [↵].
 - None: Select when the repeater has no position data.
 - Approximate: Select when the entered position data is approximate.
 - Exact: Select when the entered position data is exactly correct.

Step 16. Entering the latitude

- ① This item is displayed only when ‘Step 15. Selecting the position data accuracy level’ is set to “Approximate” or “Exact.”
1. Select “LATITUDE,” then push [↵].
 - Enters the latitude data entry mode.
 2. Rotate [DIAL] to enter the latitude.
 - ① Push [MW] to move the cursor forwards, or push [MODE] to move the cursor backwards to select a digit to enter.
 - ① To enter a north latitude, select “N,” and to enter a south latitude, select “S.”
 3. After entering, push [↵].

Step 17. Entering the longitude

- ① This item is displayed only when ‘Step 15. Selecting the position data accuracy level’ is set to “Approximate” or “Exact.”
1. Select “LONGITUDE,” then push [↵].
 - Enters the longitude data entry mode.
 2. Rotate [DIAL] to enter the longitude.
 - ① Push [MW] to move the cursor forwards, or push [MODE] to move the cursor backwards to select a digit to enter.
 - ① To enter an east longitude, select “E,” and to enter a west longitude, select “W.”
 3. After entering, push [↵].

Step 18. Setting the UTC offset

- ① UTC (Universal Time Coordinated) offset is the time difference between UTC and repeater local time. This is a useful function to know the local time of the destination repeater before you make a call. (p. 4-42)
1. Select “UTC OFFSET,” then push [↵].
 - Enters the UTC offset entry mode.
 2. Rotate [DIAL] to set the time difference between UTC and the local time, then push [↵].

Step 19. Saving the repeater list

1. Select “<<Add Write>>,” then push [↵].
 - The confirmation dialog “Add Write?” is displayed.
2. Select <YES>, then push [↵].
 - The entered contents are saved to the repeater list, and the display returns to the selected repeater group screen.

TIP: To cancel the entered data

1. Push [↵] to display “Cancel edit?” window.
2. Select <YES>, then push [↵] to cancel entry and return to the selected repeater group screen.

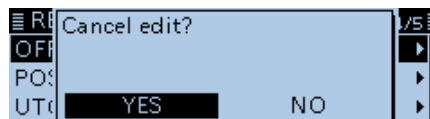

Editing a repeater list

This function edits a repeater's data. This is useful when already-entered data is incorrect, has changed, or some data needs to be added to the list.

DV Memory > Repeater List

1. Push [MENU].
2. Rotate [DIAL] to select "DV Memory," then push [↵].
3. Select "Repeater List," then push [↵].
4. Select a repeater group where the repeater you want to edit is listed, then push [↵].



(Example: 11: Japan)

- Displays the repeater list of the selected repeater group.
5. Select a repeater you want to edit, then push [QUICK].
 6. Select "Edit," then push [↵].

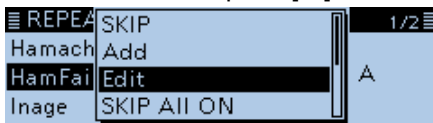

7. Select an item, then edit it.



① See pages 4-34 ~ 4-36 for details.

8. After editing, select "<<Overwrite>>."



- The confirmation dialog "OverWrite?" is displayed.

9. Select <YES>, then push [↵].

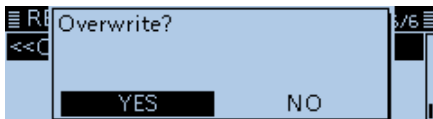

- The edited contents are saved to the repeater list, and returns to the selected repeater group screen.

10. Push [MENU].
 - Returns to the standby screen.

Deleting a repeater list

The entered repeater contents can be deleted from the repeater list.

DV Memory > Repeater List

1. Push [MENU].
2. Rotate [DIAL] to select "DV Memory," then push [↵].
3. Select "Repeater List," then push [↵].
4. Select a repeater group where the repeater you want to delete is listed, then push [↵].

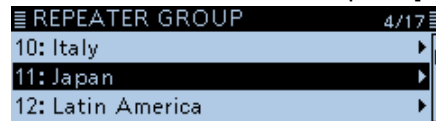

(Example: 11: Japan)

- Displays the repeater list of the selected repeater group.
5. Select the repeater to be deleted, then push [QUICK].
 6. Select "Delete," then push [↵].

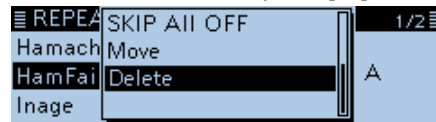

- The confirmation dialog "Delete?" is displayed.

7. Select <YES>, then push [↵].

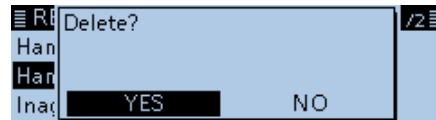

- The selected repeater contents are deleted from the repeater list, and returns to the selected repeater group screen.

8. Push [MENU].
 - Returns to the standby screen.

Rearranging the display order of the repeater

You can move the entered repeaters to rearrange their display order in the selected repeater group.
 The entered repeater cannot be moved out of their assigned repeater group.

Example: Moving "Hamacho" above "Inage."

DV Memory > Repeater List

1. Push [MENU].
2. Rotate [DIAL] to select "DV Memory," then push [↵].
3. Select "Repeater List," then push [↵].
4. Select a repeater group where the repeater you want to move is listed, then push [↵].

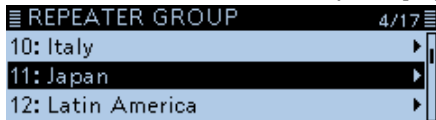

(Example: 11: Japan)

5. Select the repeater to be moved, then push [QUICK].
6. Select "Move," then push [↵].

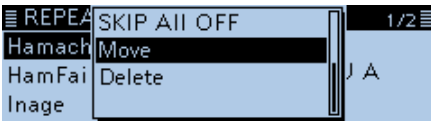

• "DESTINATION" blinks at the top left of the screen.

7. Select the location to insert the repeater you want to move, then push [↵].



• The selected repeater is inserted above the destination repeater name.

① If "<<Move End>>" is selected, the repeater is moved to the bottom of the group.



8. Push [MENU].
 - Returns to the standby screen.

Adding the Repeater information using the RX History

This section describes how to add new repeater information to the repeater list using the RX history.

1. Push [QUICK].
2. Rotate [DIAL] to select "RX History," then push [↵].

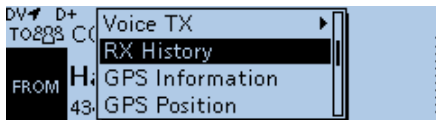

- Displays the RX HISTORY screen.

3. Rotate [DIAL] to display the repeater you want to add to the repeater list, then push [↵].

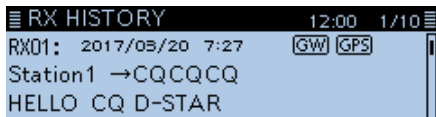

- Displays the RX history detail screen.

4. Rotate [DIAL] to display "RXRPT1" and "RXRPT2."

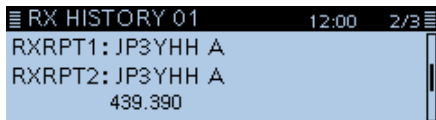

5. Push [QUICK].
6. Select "Add To RPT List," then push [↵].



7. Select the repeater call sign that you want to add to the repeater list, then push [↵].

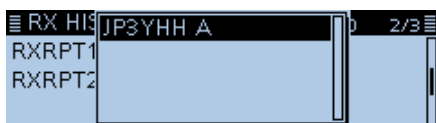

- Displays the REPEATER LIST EDIT screen. The selected repeater call sign is automatically entered.

① See pages 4-34 ~ 4-36 to edit the contents.

8. Select "<<Add Write>>," then push [↵].



- The confirmation dialog "Add Write?" is displayed.

9. Select <YES>, then push [↵].

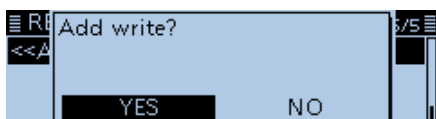

- The repeater contents are added to the repeater list, and the display returns to the RX HISTORY screen.

TIP: How to select the display type

The RX HISTORY screen has two display types, Name Display and Call Sign Display. (Default: Name Display)

1. On the RX HISTORY screen, push [QUICK].
2. Select "Name Display" or "Call Sign Display," then push [↵].

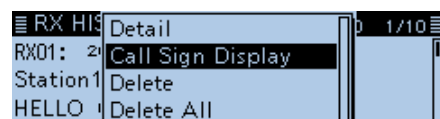

① Even if "Name Display" is selected, the call sign is displayed when a name is not entered in the DV memory.

Skip setting for the DR scan

You can set repeaters as scan skip repeaters. The selected repeaters are skipped for faster scanning. You can set the skip setting to all repeaters in the selected repeater group, or to individual repeaters.

- ① When a repeater is specified as a skip repeater, its "USE (FROM)" setting is automatically set to "NO." In that case, the repeater cannot be selected in "FROM" field (Access repeater).

◇ Individual skip setting

DV Memory > Repeater List

1. Push [MENU].
2. Rotate [DIAL] to select "DV Memory," then push [↵].
3. Select "Repeater List," then push [↵].
4. Select a repeater group where the repeater you set the skip setting is listed, then push [↵].



(Example: 11: Japan)

- Displays the repeater list of the selected repeater group.

5. Select the repeater to be skipped, then push [QUICK].
6. Select "SKIP," then push [↵].

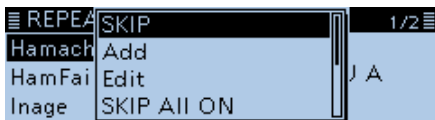

- Displays "SKIP" on the selected repeater's information window.

- ① Select "SKIP" again to cancel the skip setting.
- ① Select "SKIP All ON" to set the skip setting to all repeaters in the group.

◇ Group skip setting

1. On the REPEATER GROUP screen, select a repeater group, as described above.
2. Push [QUICK], then select "SKIP All ON" to skip the repeaters in the group during the DR scan.

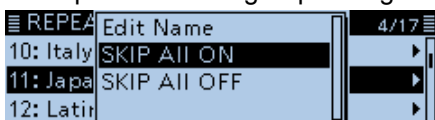

TIP:

- When you select "Repeater List" on the FROM SELECT screen, you can set the skip setting as described to the left.
- When "FROM" is selected, push [QUICK] to set the skip setting, as shown below.

① Displays "SKIP" in the "FROM" field.

Entering the repeater group name

DV Memory > Repeater List > Repeater Group

1. Push [MENU].
2. Rotate [DIAL] to select "DV Memory," then push [↵].
3. Select "Repeater List," then push [↵].
4. Select a repeater group that you edit the name.



(Example: 22:)

5. Push [QUICK].
6. Select "Edit Name," then push [↵].

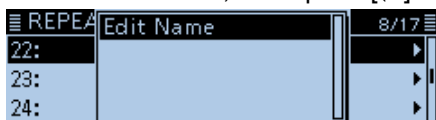

7. Enter a group name of up to 16 characters.

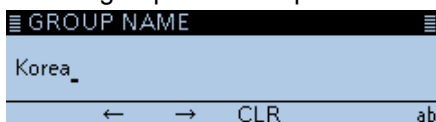

Selectable characters and symbols

A to Z, a to z, 0 to 9, ! " # \$ % & ' () * +
, - . / : ; < = > ? @ [\] ^ _ ` { | } ~ (space)

① See "Entering and editing text" for details. (p. iv)

8. After entering, push [↵].



9. Push [MENU].
 - Returns to the standby screen.

Repeater detail screen

According to the content, such as position data, UTC offset, and so on, the distance between your position and the repeater or the repeater time can be displayed on the REPEATER DETAIL screen.

The detail screen can also be entered from the FROM SELECT screen.

Example: Displaying the “Hamacho” repeater detail screen

1. Hold down [DR] for 1 second to display the DR screen.

2. Select “TO,” then push [↵].

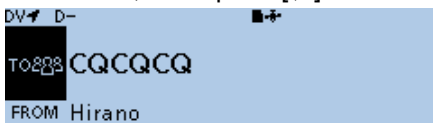

- Displays the TO SELECT screen.
- ① On the DR screen, pushing [DR] toggles between “FROM” and “TO.”

3. Select “Gateway CQ,” then push [↵].



4. Select “11: Japan,” then push [↵].

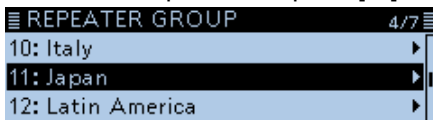

5. Select “Hamacho,” then push [QUICK].



6. Select “Detail,” then push [↵].
 - Displays the REPEATER DETAIL screen.

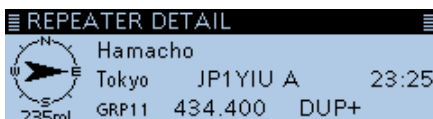
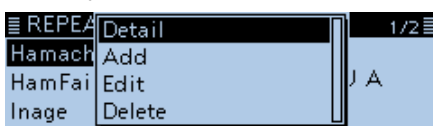

- ① If there is no position data, the distance and direction from your position are not displayed. (p. 5-3)

- ① When selecting the FM repeater, either of “FM” or “FM-N” and the tone setting are displayed.

7. Push [↵].
 - Returns to the previous screen.

The REPEATER DETAIL screen

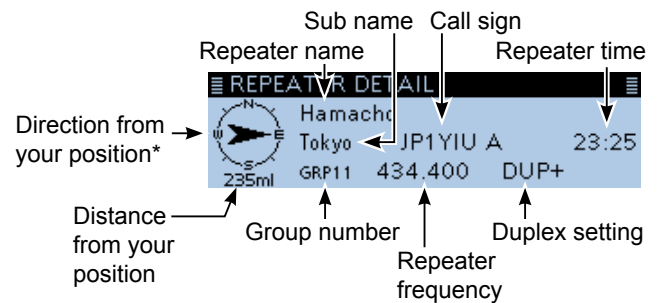

* When the position data accuracy level is set to “Approximate,” direction data is not displayed if the distance to the repeater is less than 5 kilometers.

TIP: You can display the repeater details screen when the DR screen is displayed: When you set the repeater as shown below, push [QUICK], then select “Repeater Detail.”

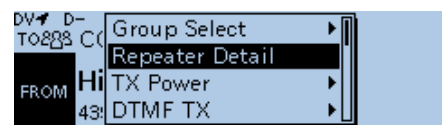
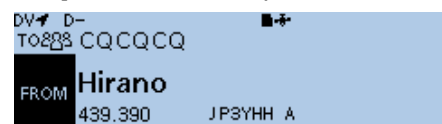

- Displays the REPEATER DETAIL screen.

Entering Your (destination) call sign

You can manually enter a Your (destination) call sign. When a Your (destination) call sign is set to "TO," you can make a call to a station, even if you do not know where the station is currently located. Up to 300 Your call signs can be entered.

Example: Entering "Station 1/JM1ZLK" to the Your Call Sign memory.

DV Memory > Your Call Sign

1. Push [MENU].
2. Rotate [DIAL] to select "DV Memory," then push [↵].
3. Select "Your Call Sign," then push [↵].
4. Push [QUICK].
5. Select "Add," then push [↵].



• Displays the YOUR CALL SIGN EDIT screen.

6. Select "NAME," then push [↵].



• Enters the name entry mode.

7. Enter a name of up to 16 characters. (Example: Station 1)



Selectable characters and symbols

A to Z, a to z, 0 to 9, !"#\$%&'()*+
 ,-./:;<=>?@[\] ^ _ ` { | } ~ (space)

① See "Entering and editing text" for details. (p. iv)

8. After entering, push [↵].
9. Select "CALL SIGN," then push [↵].



• Enters Your call sign entry mode.

10. Enter Your call sign of up to 8 characters, including spaces. (Example: JM1ZLK)

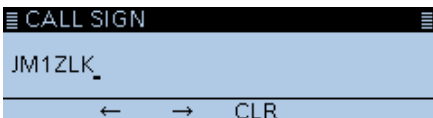

11. After entering, push [↵].

12. Select "<<Add Write>>," then push [↵].



• The confirmation dialog "Add Write?" is displayed.

13. Select <YES>, then push [↵].

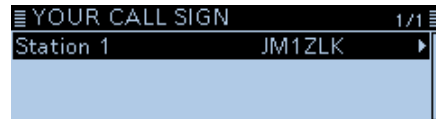
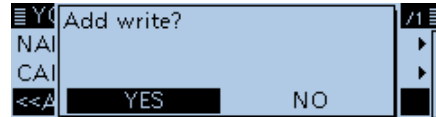

• "Station 1 JM1ZLK" is entered into the Your Call Sign memory.

14. Push [MENU].
 - Returns to the standby screen.

TIP:

To cancel the entered data

1. Push [↵] to display "Cancel edit?"
2. Select "YES" to cancel the entry and the display returns the YOUR CALL SIGN screen.

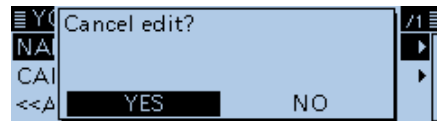

To edit the entered data:

To edit the entered data, select "Edit" in step 5. This is useful when already-entered data is incorrect, has changed or some data needs to be added to the list.

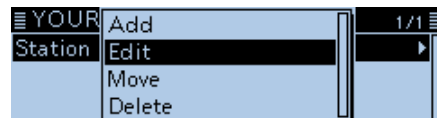

Deleting Your (destination) call sign

You can delete Your (destination) call signs from the Your Call Sign memory.

DV Memory > Your Call Sign

1. Push [MENU].
2. Rotate [DIAL] to select "DV Memory," then push [↵].
3. Select "Your Call Sign," then push [↵].
4. Push [QUICK].
5. Select "Delete," then push [↵].

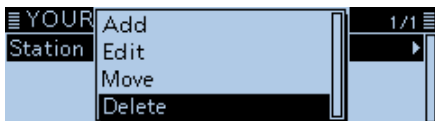

- The confirmation dialog "Delete?" is displayed.

6. Select <YES>, then push [↵].

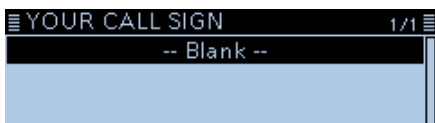

- The selected call sign contents are deleted from the Your call sign list, and the display returns to the YOUR CALL SIGN screen.

7. Push [MENU].
 - Returns to the standby screen.

TIP: You cannot delete the Your (destination) call sign if it is selected on the DR screen. In that case, the following screen is displayed.

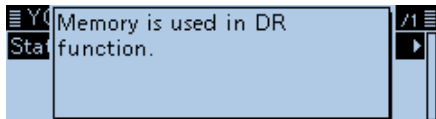

Rearranging the display order of Your (destination) call signs

You can move Your call signs to rearrange their display order.

It is easy to find stations that you often communicate with if the stations are moved to the top of the list.

Example: Moving “Station 1” above “Station 3.”

DV Memory > Your Call Sign

1. Push [MENU].
2. Rotate [DIAL] to select “DV Memory,” then push [↵].
3. Select “Your Call Sign,” then push [↵].
4. Select a Your (destination) call sign to be moved, then push [QUICK].
5. Select “Move,” then push [↵].

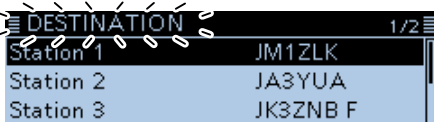
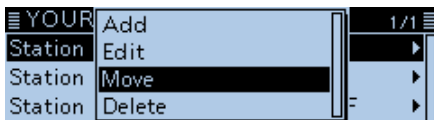

• “DESTINATION” blinks at the top left of the screen.

6. Select the location to insert the call sign you want to move, then push [↵].

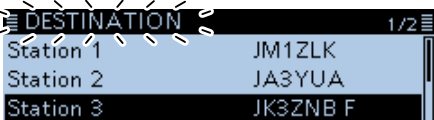

• The selected call sign is inserted to above the destination.

① If “<<Move End>>” is selected, the call sign is moved to the bottom of the list.



7. Push [MENU].
 - Returns to the standby screen.

Your setting is correct?

If you make a local area call with a gateway setting still selected in "TO," the destination repeater will be busy while you transmit. So the stations that use that repeater as their Access repeater cannot access it, as shown below. **BE SURE** to set CQCQCQ in "TO" when you intend to make a local call, or after you finish a Gateway call.

Example: JM1ZLK wants to make a Local area call.

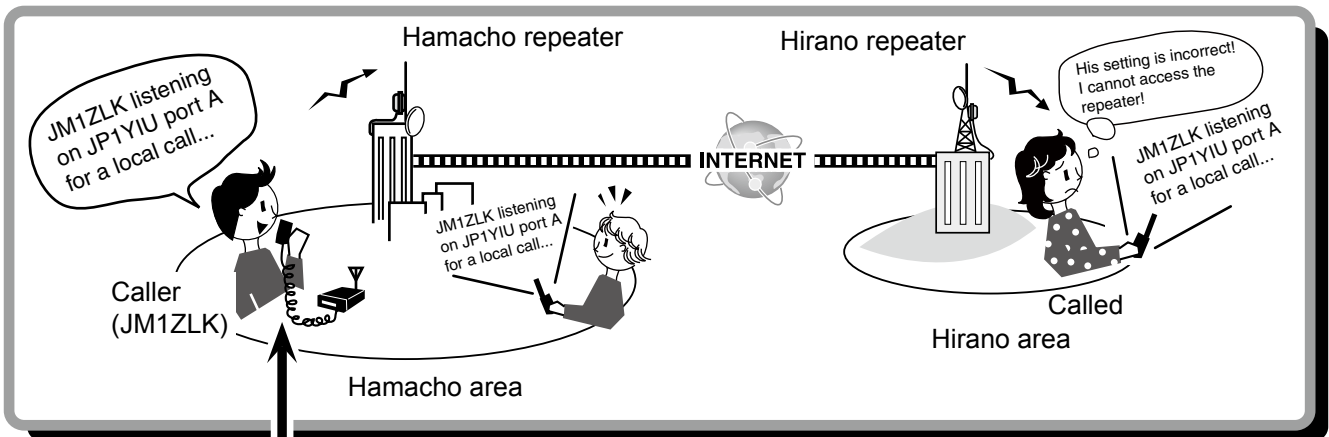

JM1ZLK's setting

```
DV D+ TX
TO888 Hirano
FROM Hamacho
439.400 JP1YIU A
UR: /JP3YHHA
```

The destination ("TO") setting is incorrect.

NOTE: With this setting, the Local area call can be made, but the destination repeater, selected in "TO," is also busy while you transmit. So the station that uses the destination repeater as their Access repeater cannot access it.

Correct setting

```
DV D+ TX
TO888 CQCQCQ
FROM Hamacho
439.400 JP1YIU A
UR: CQCQCQ
```

To make a Local area call, set the destination ("TO") to "CQCQCQ." See page 4-9 for details.

GPS operation	5-2
◇ Confirming the GPS signal receiving	5-2
◇ When a received signal contains position data	5-2
Checking your location	5-3
◇ Displaying Position Data	5-3
◇ Displayed items	5-5
◇ TX format: D-PRS Position (Mobile)	5-6
◇ TX format: D-PRS Position (Base)	5-6
◇ TX format: D-PRS Object	5-7
◇ TX format: D-PRS Item	5-7
◇ TX format: D-PRS Weather	5-8
◇ TX mode: NMEA	5-8
◇ Changing the GPS memory or alarm	5-9
◇ About the Grid Locator	5-9
◇ Changing the Compass Direction	5-10
◇ Saving your own or a received position data	5-10
Checking GPS information (Sky view screen)	5-11
Transmitting GPS data (D-PRS and NMEA)	5-12
◇ Type of position data	5-12
Transmitting D-PRS data	5-13
◇ D-PRS	5-13
◇ Operating in the D-PRS mode	5-13
◇ Displayed items	5-14
◇ Setting D-PRS Position (Mobile/Base)	5-15
◇ Setting D-PRS Object/Item	5-17
◇ Setting D-PRS Weather	5-21
◇ Weather station transmission	5-23
◇ Confirming the weather data input	5-23
◇ Application setting	5-23
◇ About the weather data content	5-23
◇ Displaying your location using a mapping software	5-24
Transmitting NMEA data	5-25
◇ Setting the GPS data sentence	5-25
◇ Entering a GPS message	5-26
Adding or editing GPS memory	5-27
◇ GPS memory	5-27
◇ Add a GPS memory	5-27
◇ Entering the GPS Memory group name	5-30
◇ Deleting GPS memory	5-30
◇ Rearranging the display order of the GPS data	5-31
◇ Setting the GPS alarm	5-32
GPS Logger function	5-34
◇ GPS Logger operating outline	5-34
◇ GPS Logger operation	5-34
◇ Setting the GPS record interval	5-34
◇ Setting the GPS record sentence	5-35
◇ Viewing the log data on a PC Map	5-36
GPS Auto transmission for only Simplex	5-38
◇ Setting the GPS automatic transmission	5-38

GPS operation

NOTE: The built-in GPS receiver cannot calculate its position data if it cannot receive signals from the GPS satellites.

The transceiver has a built-in internal GPS receiver. The GPS receiver's position data can be received in any mode. Also, a NMEA format compatible external GPS receiver can be connected to the transceiver through the [DATA] jack. To receive signals from an external GPS source, connect an external NMEA format compatible receiver to the transceiver according to the instructions, shown to the right. Position data can be transmitted in only the DV mode.

◆ Confirming the GPS signal receiving

Confirm the GPS receiver is receiving your position data.

The GPS icon blinks when searching for satellites.

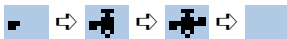

The GPS icon stops blinking when the minimum needed number of satellites is found.



- ① It may take only a few seconds to receive, or it may take a few minutes, depending on your operating environment. If you have difficulties receiving, we recommend that you try a different location.
- ① When the "GPS Select" item is set to "Manual," the icon is not displayed. (GPS > GPS Set > **GPS Select**) (p. 9-24)

Connection

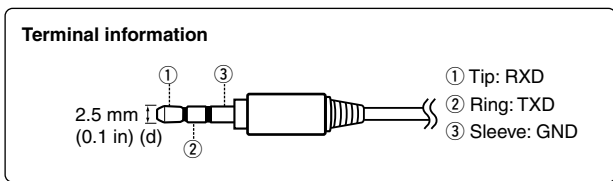
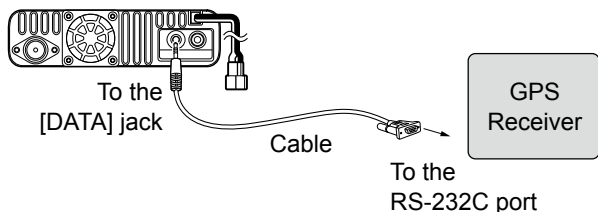

◆ When a received signal contains position data

When a received signal contains position data, the caller's position data is displayed in the RX position window. See page 5-3 for details.

Example: When the signal from JM1ZLK contains position data.

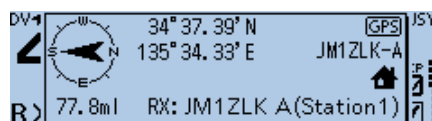

When you receive the signal, the RX position data is displayed in the RX position window.



After a few seconds, the window disappears.

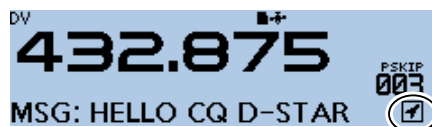

When the received signal contains position data, the RX position icon is displayed as shown above.

- ① You can turn OFF the caller's position data indication. (p. 9-63) (Display > **RX Position Display**)
- ① You can turn OFF the RX position icon indication. (p. 9-63) (Display > **RX Position Indicator**)

Checking your location

You can check your current location. This section is described using received position data.

◇ Displaying Position Data

1. Push [QUICK].
2. Select "GPS Position," then push [↵].
 - Displays the GPS POSITION screen.
3. Rotate [DIAL] to select the screen.
 - My screen (MY), the received screen (RX), the GPS Memory channel screen (MEM), and the GPS Alarm channel screen (ALM) are selectable.
 - MY: Displays your location in latitude and longitude, grid locator, altitude, speed*, time, compass heading* and course direction*.
 - * Does not displayed when "GPS Select" is set to "Manual." (p. 9-24)
 - (GPS > GPS Set > GPS Select)
 - RX: Displays the caller station's location in latitude and longitude, grid locator, altitude, distance/direction from your location, SSID, course, speed, TX power level, height, antenna gain, antenna direction, temperature, rainfall, wind direction, wind speed, barometric pressure, humidity, Time stamp, D-PRS symbol, and call sign.
 - Depending on the received signal, some data may not be displayed. (p. 5-5)
 - MEM: Displays the GPS memory channel's location in latitude and longitude, grid locator, and distance/direction from your location.
 - ALM: Displays the GPS alarm memory channel location in latitude and longitude, grid locator, and distance/direction from your location.
4. Push [↵].
 - Returns to the standby screen.

TIP: If you transmit with the GPS POSITION screen open, the screen is temporarily canceled. To check the position data while transmitting, push [QUICK], then select "GPS Position" while transmitting.

NOTE: Latitude, longitude, and altitude data may differ, depending on your GPS.

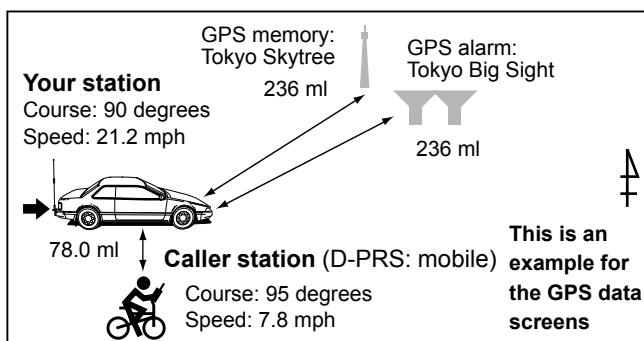

[About the GPS Position screen]

<MY> Compass direction top is North. Longitude Latitude Altitude Speed

Your course heading is East.

Displays My location

Your course direction is 90° degrees.

Grid locator

Time

<RX> When the caller's TX format is D-PRS Position (Mobile station)

Direction from your location Caller is south of you.

Displays received position screen

Distance from your location

Caller's call sign with SSID

The course heading of the caller is 95 degrees.

D-PRS symbol

Displays the time the caller acquired the position data

<MEM>

Direction from your location The location is East of you.

Displays the GPS Memory position screen

Distance from your location

<ALM>

Direction from your location The location is East of you.

Displays the GPS alarm position screen

Distance from your location

*When a name is not entered in the Memory channel, date and time are displayed instead of the name.

Checking your location (Continued)

GPS position data has two transmit modes, D-PRS and NMEA. Moreover, with the D-PRS mode data, five position formats, Position (Mobile station/Base station), Object, Item and Weather, are selectable.

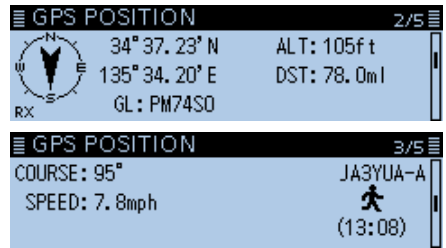
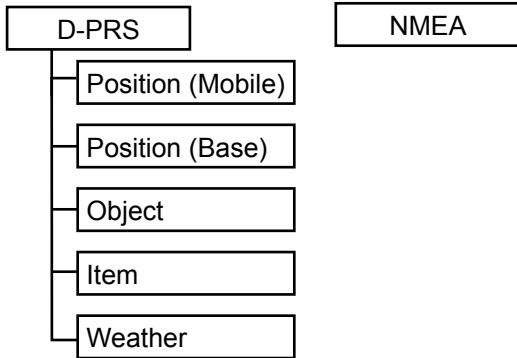

Example: When the caller's TX format is D-PRS Position (Mobile)

- D-PRS: D-PRS is a function which simultaneously sends position data received from the internal or external GPS receiver, using the slow speed data packet space, along with voice.
- Mobile: A station operating from a vehicle, a vessel, or other location, away from it's normal base location.
- Base: A station operating at home or in any building.
- Object: Transmitting Object data such as an earthquake information, satellite track information, and so on.
An Object contains a time stamp.
- Item: Transmitting Item data such as a traffic accident, lighthouse, antenna, or DV access point location, and so on.
An Item does not contain a time stamp.
- Weather: A station transmitting a weather information received from the weather device.
- NMEA: A station transmitting position data (NMEA0183) received from the internal or an external GPS receiver.

TIP: For users who have a D-STAR transceiver model prior to the ID-4100A/E:
The GPS TX mode, "GPS (DV-G)" and "GPS-A (DV-A)," are now called "NMEA" and "D-PRS."

- GPS (DV-G) → NMEA
- GPS-A (DV-A) → D-PRS

Checking your location (Continued)

◆ **Displayed items**

Depending on the caller's transmit mode or transmit format, the displayed items differ.

	NMEA	D-PRS								
		Position		Object			Item			Weather
		Mobile	Base	Data extension: OFF	Data extension: Course/Speed	Data extension: Power/Height/Gain/Directivity	Data extension: OFF	Data extension: Course/Speed	Data extension: Power/Height/Gain/Directivity	
Compass	✓	✓	✓	✓	✓	✓	✓	✓	✓	✓
Latitude	✓	✓	✓	✓	✓	✓	✓	✓	✓	✓
Longitude	✓	✓	✓	✓	✓	✓	✓	✓	✓	✓
Grid locator	✓	✓	✓	✓	✓	✓	✓	✓	✓	✓
Altitude	✓	✓	✓	✓	✓	✓	✓	✓	✓	
Distance	✓	✓	✓	✓	✓	✓	✓	✓	✓	✓
Course	✓	✓			✓			✓		
Speed	✓	✓			✓			✓		
Power			✓			✓			✓	
Height			✓			✓			✓	
Gain			✓			✓			✓	
Directivity			✓			✓			✓	
Temperature										✓
Rainfall										✓
Wind direction										✓
Wind speed										✓
Barometric pressure										✓
Humidity										✓
Symbol		✓	✓	✓	✓	✓	✓	✓	✓	✓
Time stamp	✓	✓	✓	✓	✓	✓				✓
Call sign	✓	✓	✓	✓	✓	✓	✓	✓	✓	✓

✓: Displayed

Checking your location (Continued)

◇ TX format: D-PRS Position (Mobile)

Displays the following items when the caller's TX format is D-PRS Position (Mobile).

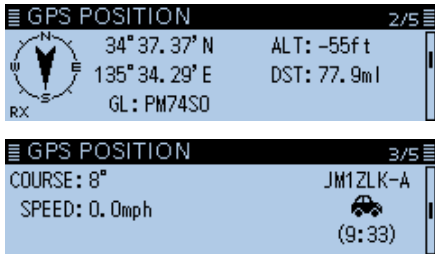

◇ TX format: D-PRS Position (Base)

Displays the following items when the caller's TX format is D-PRS Position (Base).

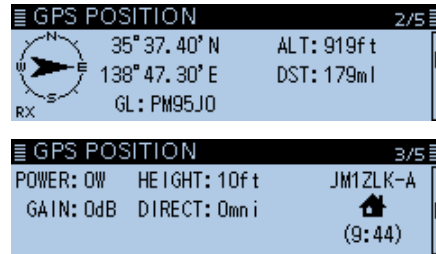

Compass	Displays the caller's direction from your location
Latitude	Displays the caller's latitude
Longitude	Displays the caller's longitude
GL	Displays the grid locator based on the caller's latitude and longitude.
ALT	Displays the caller's altitude
DST	Displays the caller's distance from your location
COURSE	Displays the caller's course over ground
SPEED	Displays the caller's speed
Symbol	Displays the caller's D-PRS symbol
GPS Time Stamp	Displays the time that the caller acquired the position data.
Call sign	Displays the caller's call sign (with SSID)

Compass	Displays the caller's direction from your location
Latitude	Displays the caller's latitude
Longitude	Displays the caller's longitude
GL	Displays the grid locator based on the caller's latitude and longitude.
ALT	Displays the caller's altitude
DST	Displays the caller's distance from your location
POWER	Displays the caller's TX power level
HEIGHT	Displays the height of the caller's antenna
GAIN	Displays the gain of the caller's antenna
DIRECT	Displays the direction the caller's antenna was pointing
Symbol	Displays the caller's D-PRS symbol
GPS Time Stamp	Displays the time that the caller acquired the position data.
Call sign	Displays the caller's call sign (with SSID)

Checking your location (Continued)

◇ TX format: D-PRS Object

Displays the following items when the caller's TX format is D-PRS Object.

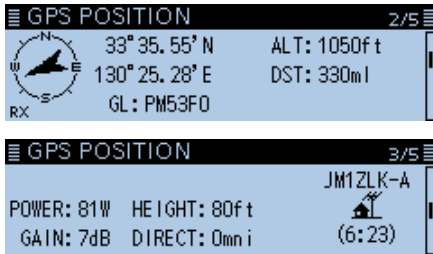

◇ TX format: D-PRS Item

Displays the following items when the caller's TX format is D-PRS Item.

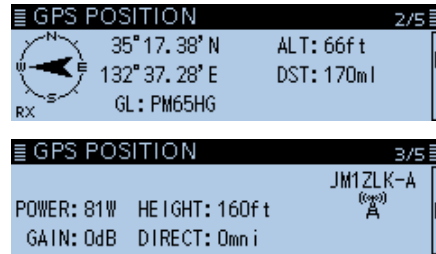

Compass	Displays the Object's direction from your location
Latitude	Displays the Object's latitude
Longitude	Displays the Object's longitude
GL	Displays the grid locator based on the Object's latitude and longitude
ALT	Displays the Object's altitude
DST	Displays the Object's distance from your location
COURSE	Displays the Object's course over ground
SPEED	Displays the Object's speed
POWER	Displays the Object's TX power level
HEIGHT	Displays the height of Object's antenna
GAIN	Displays the gain of Object's antenna
DIRECT	Displays the direction that the Object's antenna was pointing
Symbol	Displays the Object's D-PRS symbol
GPS Time Stamp	Displays the time that the caller sent the Object's data.
Call sign	Displays the caller's call sign (with SSID)

① When the Object's status is finished, "KILLED" is displayed.

Compass	Displays the Item's direction from your location
Latitude	Displays the Item's latitude
Longitude	Displays the Item's longitude
GL	Displays the grid locator based on the Item's latitude and longitude
ALT	Displays the Item's altitude
DST	Displays the Item's distance from your location
COURSE	Displays the Item's direction over ground
SPEED	Displays the Item's speed
POWER	Displays the Item's TX power level
HEIGHT	Displays the height of Item's antenna
GAIN	Displays the gain of Item's antenna
DIRECT	Displays the direction that the Item's antenna was pointing
Symbol	Displays the Item's D-PRS symbol
Call sign	Displays the caller's call sign (with SSID)

① When the Item's status is finished, "KILLED" is displayed.

Checking your location (Continued)

◇ TX format: D-PRS Weather

Displays the following items when the caller's TX format is D-PRS Weather.

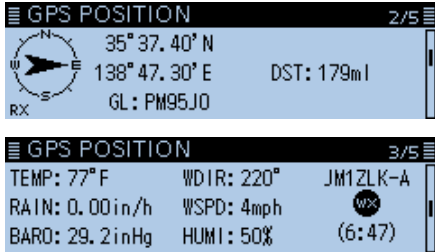

◇ TX mode: NMEA

Displays the following items when the caller's TX mode is NMEA.

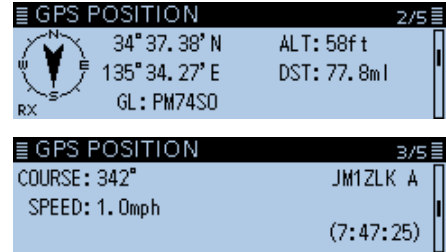

Compass	Displays the caller's direction from your location
Latitude	Displays the caller's latitude
Longitude	Displays the caller's longitude
GL	Displays the grid locator based on the caller's latitude and longitude
DST	Displays the caller's distance from your location
TEMP	Displays the temperature of the caller's area
RAIN	Displays the rainfall of the caller's area
WDIR	Displays the wind direction of the caller's area
WSPD	Displays the wind speed of the caller's area
BARO	Displays the barometric pressure of the caller's area
HUMI	Displays the humidity of the caller's area
Symbol	Displays the caller station's D-PRS symbol
GPS Time Stamp	Displays the time that the caller acquired the weather data.
Call sign	Displays the caller's call sign (with SSID)

Compass	Displays the caller's direction from your location
Latitude	Displays the caller's latitude
Longitude	Displays the caller's longitude
GL	Displays the grid locator based on the caller's latitude and longitude
ALT	Displays the caller's altitude
DST	Displays the caller's distance from your location
COURSE	Displays the caller's direction over ground
SPEED	Displays the caller's speed
GPS Time Stamp	Displays the time that the caller acquired the position data.
Call sign	Displays the caller's call sign

Checking your location (Continued)

◇ Changing the GPS memory or alarm

You can change the GPS memory or GPS alarm in the GPS POSITION screen.

1. Push [QUICK].
2. Rotate [DIAL] to select “GPS Position,” then push [↵].
 - Displays the GPS POSITION screen.
3. Rotate [DIAL] to display the MEM screen or ALM screen.
4. Push [QUICK].
5. When the MEM screen is displayed in step 3, select “GPS Memory Select,” or when the ALM screen is displayed in step 3, select “Alarm Select.”

MEM screen

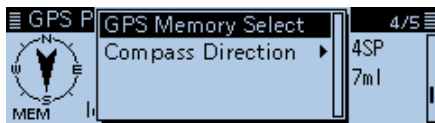
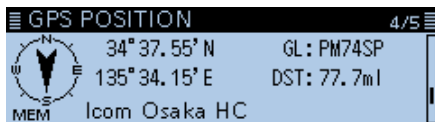

ALM screen

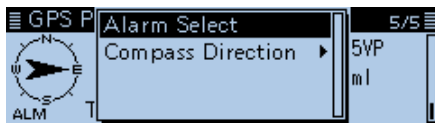

6. Select the GPS memory or GPS alarm to display on the GPS POSITION screen.
 - ① See “Adding or editing GPS memory” or “Setting the GPS alarm” for details. (pp. 5-27, 5-32)

◇ About the Grid Locator

Grid Locator (GL) is a location compressed into a 6 character code, calculated by the longitude and the latitude.

The locator is simply calculated by dividing the earth surface into squares.

It is used to find the area of a radio station.

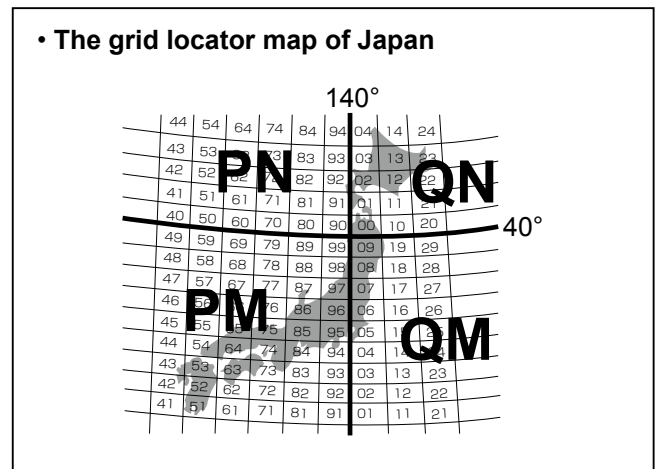
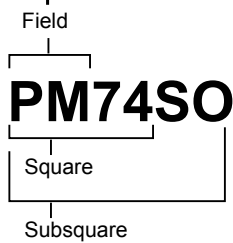
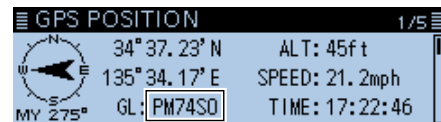

Checking your location (Continued)

◇ Changing the Compass Direction

You can change the compass direction between Heading Up, North Up, and South Up.

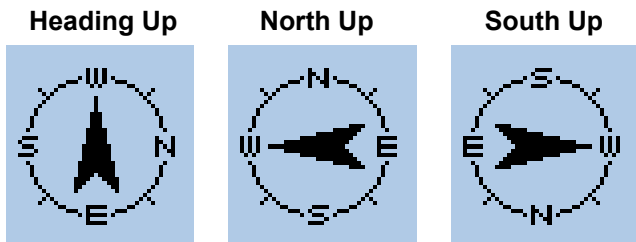

1. Push [QUICK].
2. Rotate [DIAL] to select "GPS Position," then push [↵].
 - Displays the GPS POSITION screen.
3. Push [QUICK].
4. Select "Compass Direction," then push [↵].

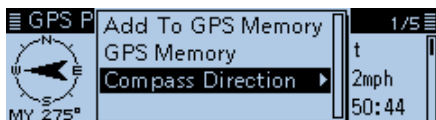

5. Select the compass direction.
 - Heading Up: The compass always points to your heading course direction.
 - North Up: The top is always north.
 - South Up: The top is always south.

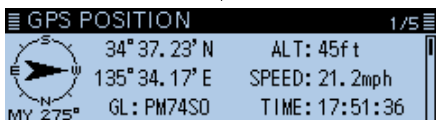
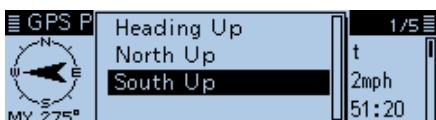

When you select "South Up."

◇ Saving your own or a received position data

You can save the position data of your station from wherever you are, and also the position data of the caller station.

The GPS Memory has a total of 300 channels, and the channels can be assigned into one of 27 banks, A ~ Z, and (No Group).

1. Push [QUICK].
2. Rotate [DIAL] to select "GPS Position," then push [↵].
 - Displays the GPS POSITION screen.
3. Select the screen that you want to save.

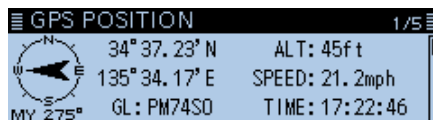

- ① To save your own position data: MY screen
- ② To save a received position data: RX screen

4. Push [QUICK].
5. Select "Add To GPS Memory," then push [↵].

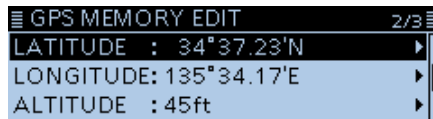
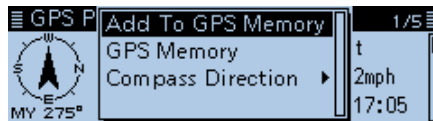

① See pages 5-27 ~ 5-29 for entering details.

6. Select "<<Add Write>>," then push [↵].

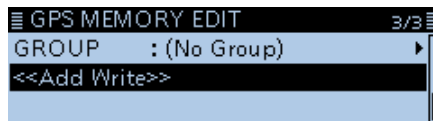

- The confirmation dialog "Add write?" is displayed.
- ① To select the destination group to be saved, select "GROUP."

7. Select <YES>, then push [↵].

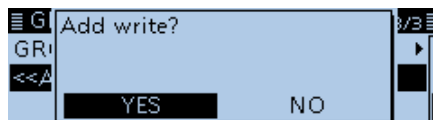

- Saves the data in the GPS memory, then returns to the GPS POSITION screen.

8. Push [↵].
 - Returns to the standby screen.

TIP: The position data is saved in the selected group with the "GROUP" item. (GPS > GPS memory)

Checking GPS information (Sky view screen)

This screen is used to view GPS satellite information when the GPS icon does not stop blinking for a long time.

GPS Information displays the quantity, signal power and location of the GPS satellites.

The sky view screen displays the location of GPS satellites. The screen also displays the direction, elevation angle, satellite numbers, and their receiving signal strength status.

1. Push [QUICK].
2. Rotate [DIAL] to select "GPS Information," then push [↵].
 - Displays the GPS INFORMATION screen.

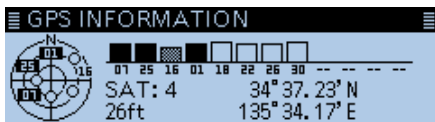

Meaning of each icon

- (○): Untracking satellite.
- (01): Tracking satellite with a weak signal, shown by the satellite number.
- (01): Tracking satellite with a strong signal, shown by the satellite number.
- (SAT): The quantity of tracking satellites.
- Altitude: The altitude of your station. The altitude is only displayed when 4 or more satellites are tracked. When 3 or less satellites are tracked, "-----ft" is displayed.
- Longitude/Latitude: Longitude and Latitude of your station.
- Signal strength graph: Signal strength of the satellites
 - : Tracking satellite with a strong signal
 - ▒: Tracking satellite with a weak signal
 - : Untracking satellite

3. Push [↵].
 - Returns to the standby screen.

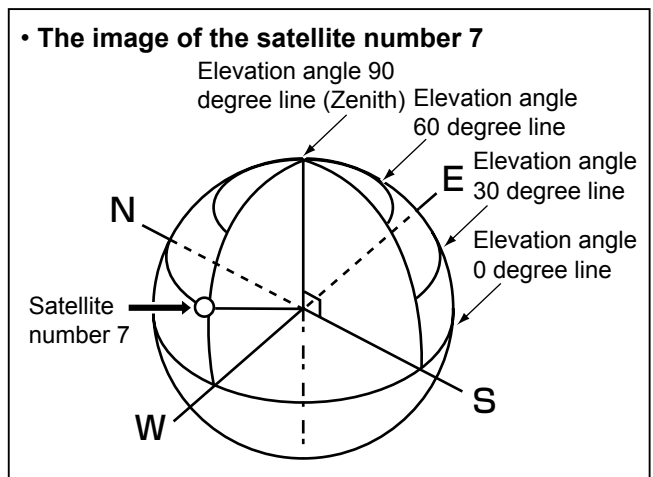
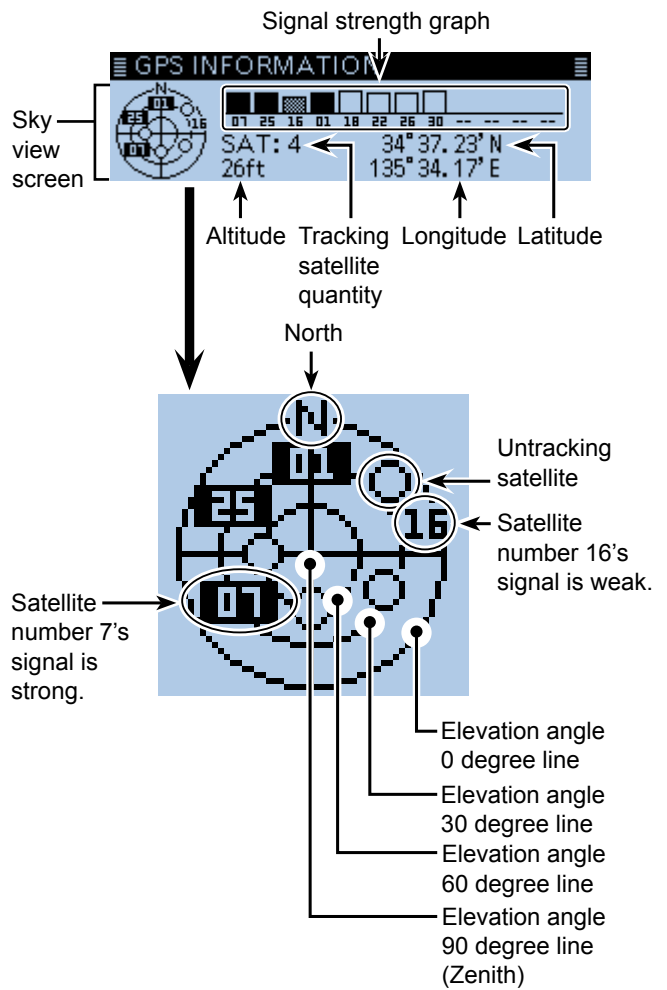

Transmitting GPS data (D-PRS and NMEA)

◇ Type of position data

GPS position data has two types of TX mode, D-PRS and NMEA. Moreover, in the D-PRS mode, you can select a TX format from Position (Mobile station/Base station), Object, Item and Weather.

Type of position data for transmission

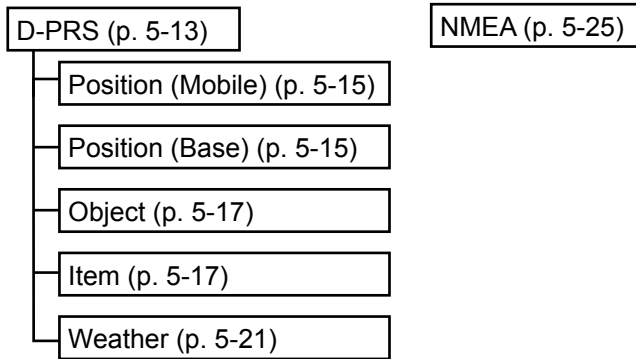

- D-PRS: D-PRS is a function that simultaneously sends position data received from the internal or external GPS receiver, using the slow speed data packet space, along with voice.
- Mobile: A station operating from a vehicle, a vessel, or other location, away from its normal base location.
You can transmit direction and speed information.
- Base: A station operating at home or in a building. You can transmit the TX power level, height, antenna gain and antenna direction information.
- Object: Transmitting Object data such as an earthquake information, satellite track information, and so on.
An Object contains a time stamp.
- Item: Transmitting Item data such as a traffic accident, lighthouse, antenna, or DV access point location, and so on.
An Item does not contain a time stamp.
- Weather: A station transmitting weather information received from a weather device.
- NMEA: A station transmitting position data (NMEA0183) received from the internal or external GPS receiver.

For users who have a D-STAR transceiver model prior to the ID-4100A/E:

The GPS TX mode, “GPS (DV-G)” and “GPS-A (DV-A),” are now called as “NMEA” and “D-PRS.”

- GPS (DV-G) → NMEA
- GPS-A (DV-A) → D-PRS

For users who have one of the following models:

(ID-800H, IC-91AD/E91, IC-U82, IC-V82, IC-7100, ID-51A/E, ID-31A/E, IC-9100, IC-80AD/E80D, ID-880H/E880, IC-92AD/E92D, IC-2820H/E2820)

When you receive a D-PRS position (Base), Object, Item or Weather signal, position data is not displayed.

Transmitting D-PRS data

When D-PRS is selected as GPS TX mode, you can transmit D-PRS data.

When operating in the D-PRS mode, the following codes are transmitted to the PC.

D-PRS code is based on APRS® code. (APRS®: Automatic Packet Reporting System).

◇ D-PRS

D-PRS is a mode that simultaneously sends position data received from the internal or external GPS receiver, using the slow speed data packet space, along with voice in the DV mode.

In an analog mode, you can transmit or receive only voice or data at one time. However a D-PRS capable radio can transmit or receive message data or GPS position data at the same time voice is being transmitted or received.

I-GATE is required to send position data to the APRS server.

NOTE:

- If “GPS select” is set to “Manual,” the manually entered position data in “Manual Position” is change to the D-PRS data format to transmit. (p. 9-24)
(GPS > GPS Set > **Manual Position**)
- Please note that if “GPS Auto TX” is set to any other setting than “OFF,” the data is transmitted according to the set time. (p. 9-40)
(GPS > **GPS Auto TX**)

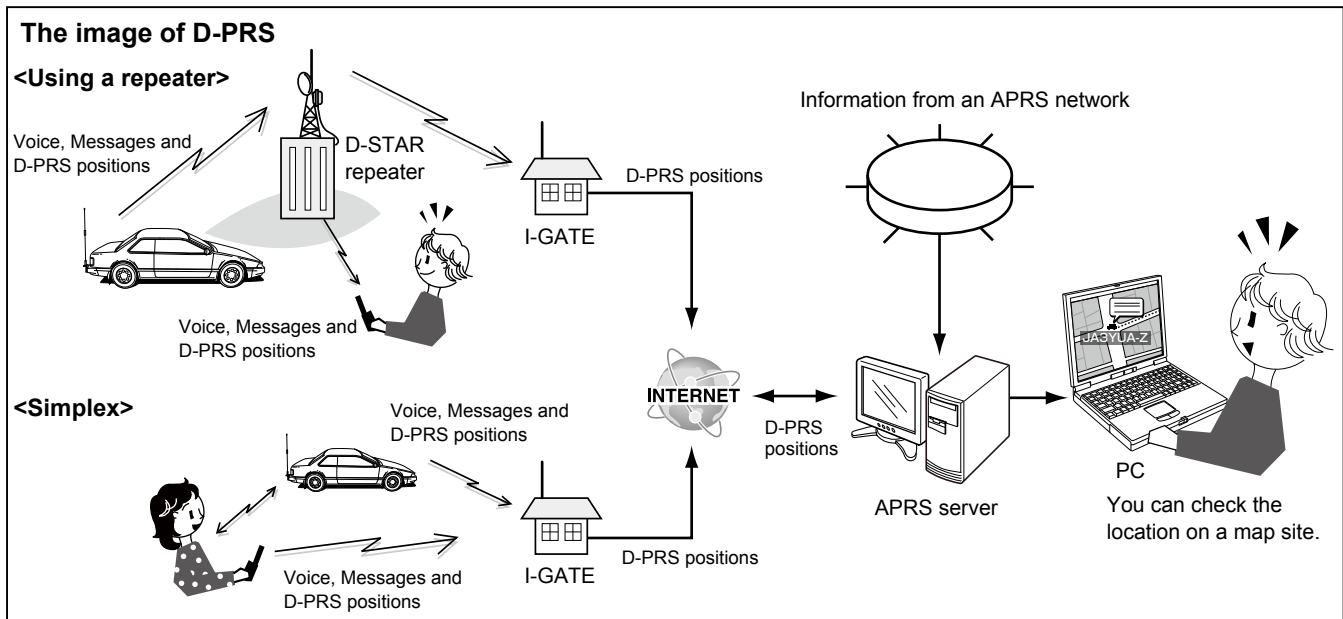

◇ Operating in the D-PRS mode

To transmit in D-PRS, follow the steps below, and for more details, see the pages listed along with the steps.

1. “MY” (Your own call sign) entering (p. 9-47)
2. Receiving GPS data (p. 5-2)
3. Set “GPS TX mode” to “D-PRS.” (p. 5-15)
 - ① Set transceivers prior to the ID-4100A/E to “GPS-A (DV-A).”
4. Set TX information (pp. 5-15 ~ 5-22)
 - ① You must set SSID and symbol.
(GPS > GPS TX Mode > D-PRS > TX Format > Position, Object, item or Weather > **SSID, Symbol**)

↓
Complete (You can transmit in the D-PRS mode.)

TIP: In the D-PRS mode, you can transmit earthquake or weather information, in addition to position data.

(GPS > GPS TX mode > **TX format**)

TX format of D-PRS

- Position (Mobile/Base): Used to transmit position data.
- Object: Used to transmit specific position data. (Contains a time stamp.)
- Item: Used to transmit specific position data. (Does not contain a time stamp.)
- Weather: Used to transmit weather information.

Transmitting D-PRS data (Continued)

◇ **Displayed items**

Depending on the TX format, the setting items and displayed order of the items differ.

	D-PRS								
	Position		Object			Item			Weather
	Mobile	Base	Data extension: OFF	Data extension: Course/Speed	Data extension: Power/Height/Gain/Directivity	Data extension: OFF	Data extension: Course/Speed	Data extension: Power/Height/Gain/Directivity	
Unproto Address	✓	✓	✓	✓	✓	✓	✓	✓	✓
Comment	✓	✓	✓	✓	✓	✓	✓	✓	✓
Altitude	✓	✓							
Object Name/Item Name			✓	✓	✓	✓	✓	✓	
Data Type			✓	✓	✓	✓	✓	✓	
Position information (Latitude/Longitude/Altitude)			✓	✓	✓	✓	✓	✓	
Data Extension	✓	✓	✓	✓	✓	✓	✓	✓	
Course				✓			✓		
Speed				✓			✓		
Power		✓			✓			✓	
Height		✓			✓			✓	
Gain		✓			✓			✓	
Directivity		✓			✓			✓	
Symbol	✓	✓	✓	✓	✓	✓	✓	✓	✓
SSID	✓	✓	✓	✓	✓	✓	✓	✓	✓
Time stamp	✓	✓	✓	✓	✓				✓

✓: Displayed

Transmitting D-PRS data (Continued)

◇ **Setting D-PRS Position (Mobile/Base)**

Set to transmit as a D-PRS Position.

1. Setting the GPS TX Mode to D-PRS

GPS > **GPS TX Mode**

1. Push [MENU].
2. Rotate [DIAL] to select “GPS,” then push [↵].
3. Select “GPS TX Mode,” then push [↵].
4. Select “D-PRS,” then push [↵].

TIP: If the TX information setting has been done, you can easily turn ON the GPS TX mode by pushing [MENU] after step 4.

- Returns to the standby screen, then displays “DPR.”

2. Checking the Unproto Address

You should use the default address, and editing is not recommended.

1. Select “Unproto Address,” then push [↵].
 - ① The default setting is “API410,DSTAR*.”
2. Push [↵].
 - Returns to the previous screen.

3. Setting the TX format to “Position”

1. Select “TX Format,” then push [↵].
2. Select “Position,” then push [↵].
 - Displays the POSITION screen.

4. Setting the Symbol

Select the symbol that indicates your operating situation. The selected symbol channel’s symbols (1~4) are transmitted along with the position data.

1. Select “Symbol,” then push [↵].
2. Select the symbol channel, then push [QUICK].
3. Select “Edit Symbol,” then push [↵].
4. Select the symbol, then push [↵].
 - ① 1:Car, 2: Van, 3: Truck, and 4:House QTH (VHF) are set as defaults.
 - ② See page 9-24 to directly edit a symbol.
5. Select the symbol channel, then push [↵].
 - Returns to the POSITION screen.

5. Setting the SSID

To assist in identifying a station’s type, the displayed APRS® (Automatic Packet Reporting System) based SSID is added after the D-PRS data call sign. The way to add SSID’s differs, depending on whether you enter a space in your call signs or not.

1. Select “SSID,” then push [↵].
2. Select the SSID, then push [↵].
 - ---: The space in call sign is converted to “-.” If no text is entered after the space, the space will be deleted, and the space is not converted to “-.”
Example: JA3YUA A > JA3YUA-A
 - (-0): No SSID is added. If a call sign includes a space, any text or digit after the space will be deleted.
 - -1~-15: Adds an SSID of -1 to -15 to your call sign.
Example: SSID is “-9.”
JA3YUA A → JA3YUA-9
 - -A~-Z: Adds an SSID of -A to -Z to your call sign.
Example: SSID is “-Z.”
JA3YUA A → JA3YUA-Z

About the SSID

To assist in identifying a station’s type, designated call sign SSIDs are used in D-PRS (APRS®), according to a common guideline. The guideline may be changed when the infrastructure environment, such as a product or network, is changed. Please check the latest guideline in the web site related to D-PRS and APRS®, and correctly set.

☞ Continued on the next page.

Transmitting D-PRS data

◇ Setting D-PRS Position (Mobile/Base) (Continued)

6. Entering a comment

Enter a comment, and transmit it with the D-PRS position data.
The number of characters you can enter differs, depending on the data extension and altitude settings. (See to the right.)

Data Extension	Altitude	Characters entered (Max.)
OFF	OFF	43 (Default)
OFF	ON	35
Course/Speed	OFF	36
Course/Speed	ON	28
Power/Height/Gain/Directivity	OFF	36
Power/Height/Gain/Directivity	ON	28

1. Select "Comment," then push [↵].
2. Select the comment number 1 ~ 4, then push [QUICK].
3. Select "Edit," then push [↵].
 - Enters the Comment entry mode.
4. Enter a comment.

Selectable characters and symbols
A to Z, a to z, 0 to 9, ! " # \$ % & ' () * + , - . / : ; < = > ? @ [\] ^ _ ` { } ~ (space)

- ① See "Entering and editing text" for details. (p. iv)
 - ① The symbol "↵" shows the transmittable comment range. Please note that the characters that exceed the range will not be transmitted.
5. After entering, push [↵].
 6. Select the entered comment number, then push [↵].

7. Setting the Time Stamp

Set the time stamp function to transmit the received time data in UTC (Universal Time Coordinated) time.

1. Select "Time Stamp," then push [↵].
2. Select the time stamp, then push [↵].
 - OFF: Does not transmit the time information.
 - DHM: Transmits the time stamp in the Day, Hour, and Minute format.
 - HMS: Transmits the time stamp in the Hour, Minute, and Second format.

8. Setting the Altitude

Set the altitude data transmission.

1. Select "Altitude," then push [↵].
2. Select "ON," then push [↵].

NOTE: If you transmit with the altitude setting ON, the character string is included in a comment on the products that cannot display the altitude. (IC-9100, IC-80AD, IC-E80D, ID-880H, ID-E880, IC-92AD, IC-E92D, IC-U82, IC-V82)

9. Setting the Data Extension

Set the data extension of your station's information.

1. Select "Data Extension," then push [↵].
2. Select the option to transmit, then push [↵].
 - OFF: Does not transmit any information.
 - Course/Speed: Transmits the course and speed data along with the position data.
 - Power/Height/Gain/Directivity: Transmits the TX power level, height, antenna gain and antenna direction, along with the position data.

10. Setting the TX power

- ① This item is displayed when "9. Setting Data Extension" is set to "Power/Height/Gain/Directivity."

Select the TX power level of the base station, to transmit along with the position data.

1. Select "Power," then push [↵].
2. Select the option, then push [↵].
 - Options: Set to between 0, 1, 4, 9, 16, 25, 36, 49, 64, and 81W.

11. Setting the antenna height

- ① This item is displayed when "9. Setting Data Extension" is set to "Power/Height/Gain/Directivity."

Select the height of the base station's antenna, to transmit along with the position data.

1. Select "Height," then push [↵].
 2. Select the option, then push [↵].
 - Options: Set to between 10, 20, 40, 80, 160, 320, 640, 1280, 2560, and 5120 feet.
- ① You can change the unit to "meter." (p. 9-64)

☞ Continued on the next page.

Transmitting D-PRS data

◇ Setting D-PRS Position (Mobile/Base) (Continued)

12. Setting the antenna gain

① This item is displayed when “9. Setting Data Extension” is set to “Power/Height/Gain/Directivity.”

Select the gain of the base station’s antenna, to transmit along with the position data.

1. Select “Gain,” then push [↵].
2. Select the option, then push [↵].
 - Options: Set to between 0 and 9 dB.

13. Setting the antenna directivity

① This item is displayed when “9. Setting Data Extension” is set to “Power/Height/Gain/Directivity.”

Select the direction the base station’s antenna was pointing, to transmit along with the position data.

1. Select “Directivity,” then push [↵].
2. Select the option, then push [↵].
 - Options: Set to between Omni, 45°NE, 90°E, 135°SE, 180°S, 225°SW, 270°W, 315°NW and 360°N.

14. Exiting the MENU screen

Push [MENU].
 • Returns to the standby screen, then displays “DV.”

◇ **Setting D-PRS Object/Item**

Set to transmit as a D-PRS Object or Item.

1. Setting the GPS TX Mode to D-PRS

GPS > GPS TX Mode

1. Push [MENU].
2. Rotate [DIAL] to select “GPS,” then push [↵].
 - Displays the GPS screen.
3. Select “GPS TX Mode,” then push [↵].
4. Select “D-PRS,” then push [↵].

TIP: If the TX information setting has been done, you can easily turn ON the GPS TX mode by pushing [MENU] after step 4.
 • Returns to the standby screen, then displays “DV.”

2. Checking the Unproto Address

You should use the default address, and editing is not recommended.

1. Select “Unproto Address,” then push [↵].
 - ① The default setting is “API410,DSTAR*.”
2. Push [↵].
 - Returns to the previous screen.

3. Setting the TX format to “Object” or “Item”

1. Select “TX Format,” then push [↵].
2. Select “Object” or “Item,” then push [↵].
 - Displays the OBJECT or ITEM screen.

4. Entering Object name or Item name

Enter an Object or Item name, such as an event information or location.

1. Select “Object Name” or “Item Name,” then push [↵].
 - Displays the “Object Name” or “Item Name” screen.
2. Enter an Object or Item name of up to 9 characters.

Selectable characters and symbols
A to Z, a to z, 0 to 9, ! " # \$ % & ' () * + , - . / : ; < = > ? @ [\] ^ _ ` { } ~ (space)

- ① See “Entering and editing text” for details. (p. iv)
3. After entering, push [↵].

Transmitting D-PRS data

◇ Setting D-PRS Object/Item (Continued)

5. Setting Data type

Set the Object or Item's status.

1. Select "Data Type," then push [↵].
2. Select the option, then push [↵].
(For an Object)
 - Live Object: The Object is valid.
 - Killed Object: The Object is invalid.
 (For an Item)
 - Live Item: The Item is valid.
 - Killed Item: The Item is invalid.

6. Setting Symbol

Select a symbol that indicates an Object or Item.

1. Select "Symbol," then push [↵].
2. Select the symbol, then push [↵].
 - ① "Radio" is set as the default.
 - ② See page 9-24 for directly editing a symbol.

7. Entering a Comment

Enter a comment to transmit as an Object or Item. The number of characters you can enter differs, depending on the data extension and altitude settings. (p. 5-19)

Data Extension	Altitude	Characters entered (Max.)
OFF	No data	43 (Default)
OFF	Set	35
Course/Speed	No data	36
Course/Speed	Set	28
Power/Height/Gain/Directivity	No data	36
Power/Height/Gain/Directivity	Set	28

1. Select "Comment," then push [↵].
2. Push [QUICK].
3. Select "Edit," then push [↵].
 - Enters the Comment entry mode.
4. Enter a comment.

Selectable characters and symbols
A to Z, a to z, 0 to 9, ! " # \$ % & ' () * + , - . / : ; < = > ? @ [\] ^ _ ` { } ~ (space)

- ① See "Entering and editing text" for details. (p. iv)
 - ② The symbol "J" shows the transmittable comment range. Please note that the characters that exceed the range will not be transmitted.
5. After entering, push [↵].
 - Displays the entered Comment.
 6. Push [↵].
 - Returns to the OBJECT or ITEM screen.

8. Setting the Position

Set the position data of an Object or Item.

For example, if you want to transmit traffic accident information as an Item, set the location where the accident has happened.

If the position data is entered in the GPS memory, you can easily set the position data from the memory.

1. Select "Position," then push [↵].
2. Push [QUICK].
3. Select "Edit," then push [↵].
 - Displays the POSITION EDIT screen.

TIP: When you select "Capture From GPS" or "Set From GPS Memory" in step 3, you can capture the position data from the GPS, or set the Object or Item's position data from the GPS memory.

Entering the latitude

4. Select "LATITUDE," then push [↵].
 - Displays the LATITUDE screen.
5. Push [MW] to move the cursor forwards, or push [MODE] to move the cursor backwards to select a digit to enter.
6. Rotate [DIAL] to enter the latitude.
 - Range: Set to between 0°00.00' to 90°00.00'.
 - ① You can change the unit to "ddd°mm'ss". (p. 9-64)
 - ② To enter a north latitude, select "N," and to enter a south latitude, select "S."
7. Repeat steps 5 and 6 to enter the latitude.
8. After entering, push [↵].

Entering the longitude

9. Select "LONGITUDE," then push [↵].
 - Displays the LONGITUDE screen.
10. Push [MW] to move the cursor forwards, or push [MODE] to move the cursor backwards to select a digit to enter.
11. Rotate [DIAL] to enter the longitude.
 - Range: Set to between 0°00.00' to 180°00.00'.
 - ① You can change the unit to "ddd°mm'ss". (p. 9-64)
 - ② To enter an east longitude, select "E," and to enter a west longitude, select "W."
12. Repeat steps 10 and 11 to enter the longitude.
13. After entering, push [↵].

☞ Continued on the next page.

Transmitting D-PRS data

◇ Setting D-PRS Object/Item

8. Setting the Position (Continued)

Entering the altitude

14. Select "ALTITUDE," then push [↵].
 - Displays the ALTITUDE screen.
15. Rotate [DIAL] to select between plus and minus.
16. Push [MW] to move the cursor forwards, or push [MODE] to move the cursor backwards to select a digit to enter.
17. Rotate [DIAL] to enter the altitude.
 - Range: Set to between -32808 and +32808 feet.
18. Repeat steps 16 and 17 to enter the altitude.
19. After entering, push [↵].
20. Select "<<Write>>," then push [↵].
 - The confirmation dialog "Write?" is displayed.
21. Select <YES>, then push [↵].
 - Writes the entered position data.
22. Push [↵].
 - Returns to the OBJECT or ITEM screen.

9. Setting the Data Extension

Set the data extension of an Object or Item's information.

1. Select "Data Extension," then push [↵].
2. Select the option to transmit, then push [↵].
 - OFF: Does not transmit any information.
 - Course/Speed: Transmits the course and speed data along with the position data.
 - Power/Height/Gain/Directivity: Transmits the TX power level, height, antenna gain and antenna direction, along with the position data.

10. Setting the Course

① This item is displayed when "9. Setting Data Extension" is set to "Course/Speed."

Set the Object or Item's course when the station moves.

1. Select "Course," then push [↵].
2. Push [MW] to move the cursor forwards, or push [MODE] to move the cursor backwards to select a digit to enter.
3. Rotate [DIAL] to enter the Object or Item's course.
 - Range: Set to between 0° and 360°.
4. Repeat steps 2 and 3 to enter the course.
5. After entering, push [↵].

11. Setting the Speed

① This item is displayed when "9. Setting Data Extension" is set to "Course/Speed."

Set the Object or Item's speed.

1. Select "Speed," then push [↵].
2. Push [MW] to move the cursor forwards, or push [MODE] to move the cursor backwards to select a digit to enter.
3. Rotate [DIAL] to enter the Object or Item's speed.
 - Range: Set to between 0 and 1150 mph.
 - ① You can change the unit to "km/h" or "knots." (p. 9-64)
4. After entering, push [↵].

12. Setting the TX power

① This item is displayed when "9. Setting Data Extension" is set to "Power/Height/Gain/Directivity."

Select the TX power level of the Object or Item if the station is a repeater, node, access point, and so on and an antenna is installed.

1. Select "Power," then push [↵].
2. Select the option, then push [↵].
 - Options: Set to between 0, 1, 4, 9, 16, 25, 36, 49, 64, and 81W.

13. Setting the antenna height

① This item is displayed when "9. Setting Data Extension" is set to "Power/Height/Gain/Directivity."

Select the height of the Object or Item's antenna if the station is a repeater, node, access point, and so on and an antenna is installed.

1. Select "Height," then push [↵].
2. Select the option, then push [↵].
 - Options: Set to between 10, 20, 40, 80, 160, 320, 640, 1280, 2560, and 5120 feet.
 - ① You can change the unit to "meter." (p. 9-64)

14. Setting the antenna gain

① This item is displayed when "9. Setting Data Extension" is set to "Power/Height/Gain/Directivity."

Select the gain of the Object or Item antenna.

1. Select "Gain," then push [↵].
2. Select the option, then push [↵].
 - Options: Set to between 0 and 9 dB.

☞ Continued on the next page.

Transmitting D-PRS data

◇ Setting D-PRS Object/Item (Continued)

15. Setting the antenna directivity

① This item is displayed when “9. Setting Data Extension” is set to “Power/Height/Gain/Directivity.”

Select the direction the base Object or Item’s antenna was pointing.

1. Select “Directivity,” then push [↵].
2. Select the option, then push [↵].
 - Options: Set to between Omni, 45°NE, 90°E, 135°SE, 180°S, 225°SW, 270°W, 315°NW and 360°N.

16. Setting the SSID

To assist in identifying a station’s type, the displayed APRS® (Automatic Packet Reporting System) based SSID is added after the D-PRS data call sign. The way to add SSID’s differs, depending on whether you enter a space in your call signs or not.

1. Select “SSID,” then push [↵].
2. Select the SSID to set, then push [↵].
 - ---: The space in call sign is converted to “-.” If no text is entered after the space, the space will be deleted, and the space is not converted to “-.”
Example: JA3YUA A > JA3YUA-A
 - (-0): No SSID is added. If a call sign includes a space, any text or digit after the space will be deleted.
 - -1~-15: Adds an SSID of -1 to -15 to your call sign.
Example: SSID is “-9.”
JA3YUA A → JA3YUA-9
 - -A~-Z: Adds an SSID of -A to -Z to your call sign.
Example: SSID is “-Z.”
JA3YUA A → JA3YUA-Z

About the SSID

To assist in identifying a station’s type, designated call sign SSIDs are used in D-PRS (APRS®), according to a common guideline. The guideline may be changed when the infrastructure environment, such as a product or network, is changed. Please check the latest guideline in the web site related to D-PRS and APRS®, and correctly set.

17. Setting Time Stamp

① This item is displayed when the TX format is “Object.”

Set the time stamp function to transmit the Object’s time data in UTC (Universal Time Coordinated) time.

1. Select “Time Stamp,” then push [↵].
2. Select the time stamp, then push [↵].
 - DHM: Transmits the time stamp in the Day, Hour, and Minute format.
 - HMS: Transmits the time stamp in the Hour, Minute, and Second format.

18. Exiting the MENU screen

Push [MENU].
• Returns to the standby screen, then displays “DW.”

Transmitting D-PRS data (Continued)

◇ **Setting D-PRS Weather**

Set to transmit as a D-PRS Weather station.

1. Setting the GPS TX Mode to D-PRS

GPS > **GPS TX Mode**

1. Push [MENU].
2. Rotate [DIAL] to select “GPS,” then push [↵].
 - Displays the GPS screen.
3. Select “GPS TX Mode,” then push [↵].
4. Select “D-PRS,” then push [↵].

TIP: If the TX information setting has been done, you can easily turn ON the GPS TX mode by pushing [MENU] after step 4.

- Returns to the standby screen, then displays “DPR.”

2. Checking the Unproto Address

You should use the default address, and editing is not recommended.

1. Select “Unproto Address,” then push [↵].
 - ① The default setting is “API410,DSTAR*.”
2. Push [↵].
 - Returns to the previous screen.

3. Setting the TX format to “Weather”

1. Select “TX Format,” then push [↵].
2. Select “Weather,” then push [↵].
 - Displays the WEATHER screen.

4. Setting Symbol

Select a symbol that indicates the weather station.

1. Select “Symbol,” then push [↵].
2. Select the symbol, then push [↵].
 - ① See page 9-24 for directly editing a symbol.
 - ① “WX Station” is set as the default.

5. Setting the SSID

To assist in identifying a station’s type, the displayed APRS® (Automatic Packet Reporting System) based SSID is added after the D-PRS data call sign. The way to add SSID’s differs, depending on whether you enter a space in your call signs or not.

1. Select “SSID,” then push [↵].
2. Select the SSID to set, then push [↵].
 - ---: The space in call sign is converted to “-.” If no text is entered after the space, the space will be deleted, and the space is not converted to “-.”
Example: JA3YUA A > JA3YUA-A
 - (-0): No SSID is added. If a call sign includes a space, any text or digit after the space will be deleted.
 - -1~-15: Adds an SSID of -1 to -15 to your call sign.
Example: SSID is “-9.”
JA3YUA A → JA3YUA-9
 - -A~-Z: Adds an SSID of -A to -Z to your call sign.
Example: SSID is “-Z.”
JA3YUA A → JA3YUA-Z

About the SSID

To assist in identifying a station’s type, designated call sign SSIDs are used in D-PRS (APRS®), according to a common guideline. The guideline may be changed when the infrastructure environment, such as a product or network, is changed. Please check the latest guideline in the web site related to D-PRS and APRS®, and correctly set.

☞ Continued on the next page.

Transmitting D-PRS data

◇ Setting D-PRS Weather (Continued)

7. Entering a Comment

Enter a comment to transmit as a D-PRS Weather station.

1. Select "Comment," then push [↵].
2. Push [QUICK].
3. Select "Edit," then push [↵].
 - Displays the "Comment" screen.
4. Enter a comment of up to 43 characters.

Selectable characters and symbols

A to Z, a to z, 0 to 9, ! " # \$ % & ' () * +
, - . / : ; < = > ? @ [\] ^ _ ` { | } ~ (space)

- ① See "Entering and editing text" for details. (p. iv)
- ① The symbol "J" shows the transmittable comment range. Please note that the characters that exceed the range will not be transmitted.
5. After entering, push [↵].
6. Push [↵].
 - Returns to the WEATHER screen.

8. Setting Time Stamp

Set the time stamp function to transmit the received time data in UTC (Universal Time Coordinated) time.

1. Select "Time Stamp," then push [↵].
2. Select the time stamp," then push [↵].
 - OFF: Does not transmit the time information.
 - DHM: Transmits the time stamp in the Day, Hour, and Minute format.
 - HMS: Transmits the time stamp in the Hour, Minute, and Second format.

9. Exiting the MENU screen

Push [MENU].

- Returns to the standby screen, then displays "DV-1."

Transmitting D-PRS data (Continued)

◇ Weather station transmission

When you transmit as a weather station, you should set the weather station's settings, and input the weather data to the [DATA] terminal. You can input the weather data from a third party's weather device by converting it to the APRS weather format in your PC or microcomputer.

After completing the weather station's settings, and inputting the weather data, you can transmit as a weather station.

NOTE: If the weather data is not input to the [DATA] terminal, you cannot transmit as a weather station.

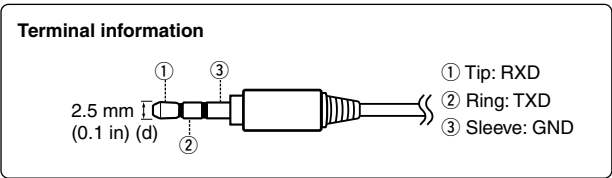
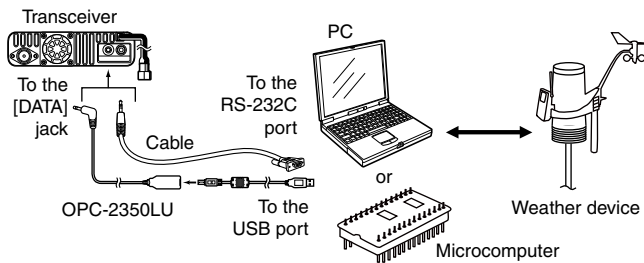

◇ Confirming the weather data input

You can confirm whether or not the weather data is input to the [DATA] terminal.

1. Set the "GPS TX Mode" to "D-PRS," and the "TX format" to "Weather." (pp. 5-21, 5-22)
 2. On the standby screen, push [QUICK].
 3. Rotate [DIAL] to select "Weather Information," then push [↵].
 - Displays the weather information screen as shown below if the weather data is input to the [DATA] terminal.
- ① When the weather information is displayed, you can transmit as a weather station. If "-" is displayed on the screen, the weather data does not input to the [DATA] terminal. In that case, check the input data settings.

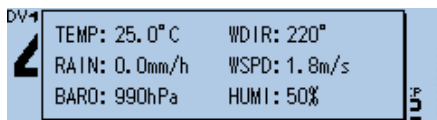

◇ Application setting

Configure the communication software as follows.

- Port: The COM port number that is used by the ID-4100A/E.*¹
- Baud rate: 4800/9600 bps*²
- Data: 8 bit
- Parity: none
- Start: 1 bit
- Stop: 1 bit
- Flow control: none

*¹ Depending on the PC environment, the COM port number used by the ID-4100A/E may be higher than 5. In that case, use an application that can set it to higher than 5.

*² Set the baud rate in the "Data Speed" item. (Function > **Data Speed**) (p. 9-60)

◇ About the weather data content

The weather data should be input according to the format (based on the APRS® Weather Data) as shown below.

Example:

220/004g005t077r000p000P000h50b09900 End code
 1 2 3 4 5 6 7 8 9

No.	Item	Value	Unit
1	Wind direction	000 to 360	°
2	Wind speed	000 to 999	mph
3	Gust speed	g000 to g999	mph
4	Temperature	t-99 to t-01, t000 to t999	°F
5	Rainfall	r000 to r999* ¹	inch
6	Rainfall (24 Hours)	p000 to p999* ¹	inch
7	Rainfall (Midnight)	P000 to P999* ¹	inch
8	Humidity	h00, h01 to h99 (h00 indicates 100%.)	%
9	Barometric pressure	b00000 to b99999* ²	hPa, mb

*¹ The last two digits indicate the two decimal place.

*² The last digit indicates the one decimal place.

- ① If you have no data, enter a space or "." (period) instead of a number.
(Example: ".../...g...t077r000p...P...h50b.....")
- ① Enter <CR>, <LF> or <CR><LF> for an end code.

Transmitting D-PRS data (Continued)

◇ Displaying your location using a mapping software

If you transmit to an I-GATE station, and then enter the call sign information on the internet map website, the set symbol is displayed.

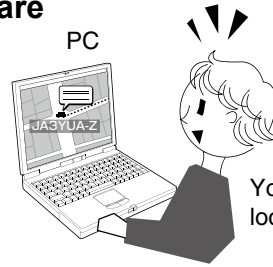

You can check the location at a map site.

For your reference

D-PRS data content

D-PRS data content are shown below.

◇ Position (Mobile)

(e.g.) JA3YUA-A>API410,DSTAR*:/002338h3437.38N/13534.29E>090/002/A=000012ID-4100 OP.SATOH
 ① ② ③ ④ ⑦ ⑧ ⑨ ⑩ ⑨ ⑪ ⑬ ⑭

◇ Position (Base)

(e.g.) JA3YUA-A>API410,DSTAR*:/002338h3437.38N/13534.29E-PHG5132/ID-4100 OP.SATOH
 ① ② ③ ④ ⑦ ⑧ ⑨ ⑩ ⑨ ⑫ ⑭

◇ Object

(e.g.) JA3YUA-A>API410,DSTAR*;;HAM FESTA*012345z3437.38N\13534.29Eh/2017.4.1 am10-pm4
 ① ② ③ ④ ⑤ ⑥ ⑦ ⑧ ⑨ ⑩ ⑨ ⑭

◇ Item

(e.g.) JA3YUA-A>API410,DSTAR*;)REPEATER!3454.00N/13536.00ErPHG5132/439.39MHz DV RPT JP3YHH A
 ① ② ③ ④ ⑤ ⑥ ⑧ ⑨ ⑩ ⑨ ⑫ ⑭

◇ Weather

(e.g.) JA3YUA-A>API410,DSTAR*:/012345z3454.00N/13536.00E_220/004g005t077r000p000P000h50b09900
 ① ② ③ ④ ⑦ ⑧ ⑨ ⑩ ⑨ ⑮ ⑯ ⑰ ⑱ ⑲ ⑳ ㉑ ㉒

- ① Call sign
- ② SSID
- ③ Unproto Address
- ④ D-PRS Data type
 / Position with time stamp
 ! Position without time stamp
 ; Object
) Item
- ⑤ Object Name/Item Name
- ⑥ Data Type
 * Live Object
 ! Live Item
 _ Killed Object/Killed Item
- ⑦ Time Stamp(UTC)
 h Hour Minute Second
 z Day Hour Minute
- ⑧ Latitude
- ⑨ Symbol
- ⑩ Longitude
- ⑪ Data Extension(Course/Speed)
 Course:0 ~ 360°
 Speed:0 ~ 999 knots

⑫ Data Extension(PHG codes)
 PHG codes definitions

	0	1	2	3	4	5	6	7	8	9	
First: Power	0	1	4	9	16	25	36	49	64	81	(W)
Second: Height	10	20	40	80	160	320	640	1280	2560	5120	(feet)
Third: Gain	0	1	2	3	4	5	6	7	8	9	(dB)
Fourth: Directivity	omni	45°NE	90°E	135°SE	180°S	225°SW	270°W	315°NW	360°N	-	-

- ⑬ Altitude
 -99999 ~ 999999 feet
- ⑭ Comment
- ⑮ Wind direction/Wind speed
 Wind direction:0 ~ 360°
 Wind speed: 0 ~ 999 mph
- ⑯ Gust speed
 0 ~ 999 mph
- ⑰ Temperature
 -99 ~ 999°F
- ⑱ Rainfall
 0.00 ~ 9.99 inch
- ⑲ Rainfall (24 Hours)
 0.00 ~ 9.99 inch
- ⑳ Rainfall (Midnight)
 0.00 ~ 9.99 inch
- ㉑ Humidity
 1 ~ 99%, 00=100%
- ㉒ Barometric pressure
 0.0 ~ 9999.9 hPa

Transmitting NMEA data

Set a GPS sentence to transmit GPS data in the DV mode.

◆ Setting the GPS data sentence

GPS > GPS TX Mode > NMEA > **GPS Sentence**

1. Push [MENU].
2. Rotate [DIAL] to select “GPS,” then push [↵].
3. Select “GPS TX Mode,” then push [↵].
4. Select “NMEA,” then push [↵].
5. Select “GPS Sentence,” then push [↵].
 - Displays the “GPS Sentence” screen.
6. Rotate [DIAL] to select the GPS sentence, then push [↵].

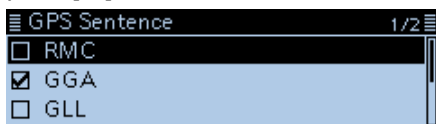

- Displays “✓” when the sentence is set to ON.
 - ① The selectable GPS sentences are RMC, GGA, GLL, VTG, GSA and GSV. The GGA sentence is set to ON as the default GPS sentence.
7. Repeat step 6 to set the GPS sentence.
 - ① A maximum of four GPS sentences can be set at a time.
 8. Push [MENU].
 - Returns to the standby screen, then displays “DV.”

NOTE:

- Set the GSV sentence to OFF when sending the GPS message to a conventional digital transceivers (IC-2820H, IC-E2820, ID-800H, IC-91AD, IC-E91, IC-V82, IC-U82, IC-2200H). The GSV sentence is incompatible with them.
- If “GPS Select” is set to “Manual,” the transceiver automatically sets the NMEA sentence, and transmits it along with the manually entered position data in “Manual Position.” (p. 9-24) (GPS > GPS Set > **Manual Position**)
- Please note that if “GPS Auto TX” is set to any other setting than “OFF,” the data is automatically transmitted according to the set time. (p. 9-40) (GPS > **GPS Auto TX**)

TIP: To return to the default setting:

1. Push [QUICK] in step 6.
2. Select “Default,” then push [↵].

The display while transmitting NMEA data

Displayed when “GPS TX Mode” is set to “NMEA.”

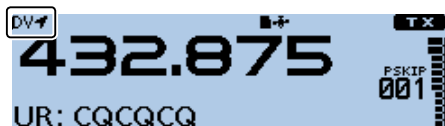

- ① When you transmit, the set GPS sentence is also transmitted.

• Contents of GPS sentence

Sentence	Lon /Lat	Alt	UTC	Date (UTC)	Status	2D /3D	COG (True)	SOG (knot)	Others
RMC	✓		✓	✓	✓		✓	✓	Magnetic variation, Mode Indicator
GGA	✓	✓	✓		✓				Number of satellites in use, HDOP, Geoidal separation, Age of Differential GPS data
GLL	✓		✓		✓				Mode Indicator
VTG							✓	✓	COG (Magnetic north), SOG (km/h), Mode Indicator
GSA					✓	✓			ID numbers of satellites used in solution, PDOP, HDOP, VDOP
GSV									Total number of sentences, Sentence number, Total number of satellites in view, Satellite information (ID, Elevation, Azimuth, S/N)

Transmitting NMEA data (Continued)

◇ Entering a GPS message

Enter a GPS message to be transmitted with the position data.

Example: Entering “Japan TOM”

GPS > GPS TX Mode > NMEA > **GPS Message**

1. Push [MENU].
2. Rotate [DIAL] to select “GPS,” then push [↵].
• Displays the GPS screen.
3. Select “GPS TX Mode,” then push [↵].
4. Select “NMEA,” then push [↵].
5. Select “GPS Message,” then push [↵].
• Displays the “GPS Message” screen.
6. Push [QUICK].
7. Select “Edit,” then push [↵].



• Enters the GPS message entry mode.

8. Enter a GPS message of up to 20 characters.

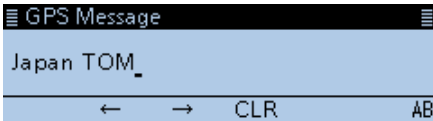

(Example: Japan TOM)

Selectable characters and symbols

A to Z, a to z, 0 to 9, ! " # \$ % & ' () * +
, - . / : ; < = > ? @ [\] ^ _ ` { | } ~ (space)

① See “Entering and editing text” for details. (p. iv)

9. After entering, push [↵].
• Displays the entered message.

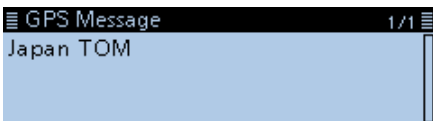

10. Push [MENU].
• Returns to the standby screen.

Adding or editing GPS memory

◇ GPS memory

You can add GPS data to GPS Memory. You can add your own position data, other station's position data, or any position data that are manually entered.

The GPS Memory is capable of storing a total of 300 channels, and conveniently saved in up to 27 groups, from A to Z and "(No Group)." The A to Z groups can also be named.

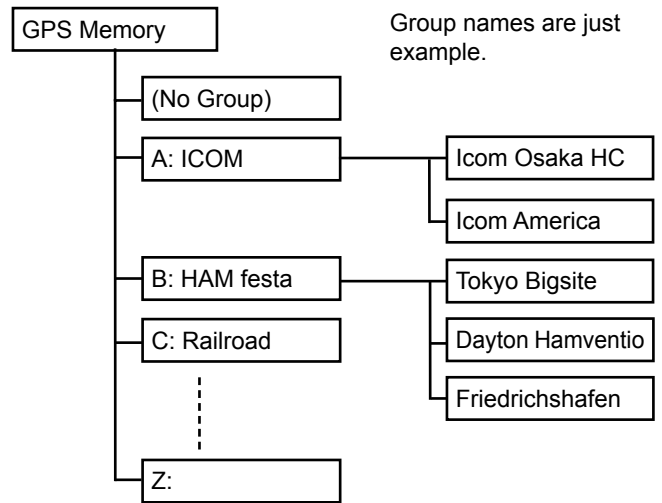

◇ Add a GPS memory

Example: Add "HOME" into (No Group)

1. Adding GPS Memory and entering the edit mode

GPS > GPS Memory

1. Push [MENU].
2. Rotate [DIAL] to select "GPS," then push [↵].
3. Select "GPS Memory," then push [↵].
 - The previously added GPS memories are displayed on the GPS MEMORY screen.
4. Select "(No Group)," then push [↵].
5. Push [QUICK].
6. Select "Add," then push [↵].



• Displays the GPS MEMORY EDIT screen.

TIP: To edit the previously saved GPS memory, select "Edit" in the step 6. You can enter the content in the same way as described above.

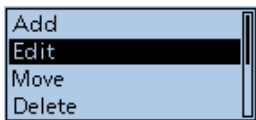

2. Entering the GPS Memory name

1. Select "NAME," then push [↵].
 - Enters the GPS Memory name entry mode.
2. Enter a GPS memory name of up to 16 characters.



(Example: HOME)

Selectable characters and symbols

A to Z, a to z, 0 to 9, ! " # \$ % & ' () * + , - . / : ; < = > ? @ [\] ^ _ ` { | } ~ (space)

- ① See "Entering and editing text" for details. (p. iv)
3. After entering, push [↵].
 - Returns to the GPS MEMORY EDIT screen.

Adding or editing GPS memory

◇ Add a GPS memory (Continued)

3. Entering the GPS Memory date

1. Select "DATE," then push [↵].
 - Enters the date entry mode.
2. Push [MW] to move the cursor forwards, or push [MODE] to move the cursor backwards to select a digit to enter.
3. Rotate [DIAL] to enter the date.
 - Range: Set to between 2000/01/02 and 2099/12/30.
4. Repeat steps 2 and 3 to enter the date.

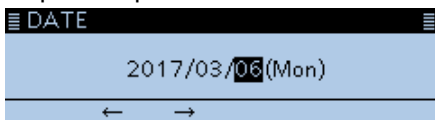

5. After entering, push [↵].

4. Entering the GPS Memory time

1. Select "TIME," then push [↵].
 - Enters the time entry mode.
2. Push [MW] to move the cursor forwards, or push [MODE] to move the cursor backwards to select a digit to enter.
3. Rotate [DIAL] to enter the time.
 - Range: Set to between 00:00:00 and 23:59:59.
4. Repeat steps 2 and 3 to enter the time.

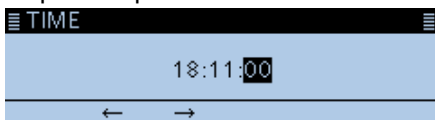

5. After entering, push [↵].

5. Entering the GPS Memory latitude

1. Select "LATITUDE," then push [↵].
 - Displays the LATITUDE screen.
2. Push [MW] to move the cursor forwards, or push [MODE] to move the cursor backwards to select a digit to enter.
3. Rotate [DIAL] to enter the latitude.
 - Range: Set to between 0°00.00' to 90°00.00'.
 - ① You can change the unit to "ddd°mm'ss". (p. 9-64)
 - ① To enter a north latitude, select "N," and to enter a south latitude, select "S."
4. Repeat steps 2 and 3 to enter the latitude.



5. After entering, push [↵].

6. Entering the GPS Memory longitude

1. Select "LONGITUDE," then push [↵].
 - Displays the LONGITUDE screen.
2. Push [MW] to move the cursor forwards, or push [MODE] to move the cursor backwards to select a digit to enter.
3. Rotate [DIAL] to enter the longitude.
 - Range: Set to between 0°00.00' to 180°00.00'.
 - ① You can change the unit to "ddd°mm'ss". (p. 9-64)
 - ① To enter an east longitude, select "E," and to enter a west longitude, select "W."
4. Repeat steps 2 and 3 to enter the longitude.



5. After entering, push [↵].

7. Entering the GPS Memory altitude

1. Select "ALTITUDE," then push [↵].
 - Displays the ALTITUDE screen.
2. Rotate [DIAL] to select between plus and minus.
3. Push [MW] to move the cursor forwards, or push [MODE] to move the cursor backwards to select a digit to enter.
4. Rotate [DIAL] to enter the altitude.
 - Range: Set to between -32808 and +32808 feet.
5. Repeat steps 3 and 4 to enter the altitude.

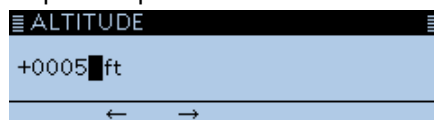

6. After entering, push [↵].

8. Selecting the GPS memory group

1. Select "GROUP," then push [↵].
2. Select the group between (No Group) and A ~ Z.



① A total of up to 300 memories can be saved.

☞ Continued on the next page

Adding or editing GPS memory

◇ Add a GPS memory (Continued)

9. Writing the GPS memory

1. Select "<<Add Write>>," then push [↵].
 - The confirmation dialog "Add write?" is displayed.
 - ① If a previously added GPS memory was edited, select "<<Overwrite>>."
2. Select <YES>, then push [↵].

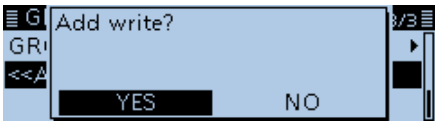

- The data is added to the GPS memory, and then the selected GPS Memory group screen is displayed.
3. Push [MENU].
 - Returns to the standby screen.

To view the entered content:

To view the entered content, select the GPS memory channel.



To cancel the entered data:

To cancel the entered data, push [↵] to display the confirmation dialog, as shown below. Select <YES> to cancel entering and the display returns to the GPS Memory group screen.

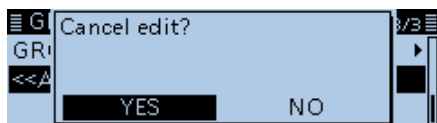

Adding or editing GPS memory (Continued)

◇ **Entering the GPS Memory group name**

You can enter a name for each GPS Memory group.

GPS > GPS Memory

1. Push [MENU].
2. Rotate [DIAL] to select “GPS,” then push [↵].
3. Select “GPS Memory,” then push [↵].
 - Displays the GPS MEMORY screen.
4. Select the group that the name to be entered, then push [QUICK].
5. Select “Edit Name,” then push [↵].

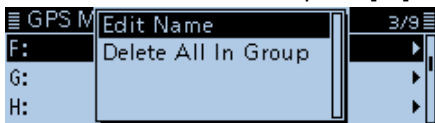

• Enters the Group Name entry mode.

6. Enter a GPS group name of up to 16 characters.

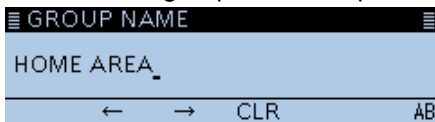

(Example: HOME AREA)

Selectable characters and symbols

A to Z, a to z, 0 to 9, ! " # \$ % & ' () * + , - . / : ; < = > ? @ [\] ^ _ ` { | } ~ (space)

① See “Entering and editing text” for details. (p. iv)

7. After entering, push [↵].

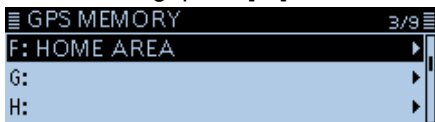

8. Push [MENU].
 - Returns to the standby screen.

◇ **Deleting GPS memory**

You can delete the GPS memories.

Please note that deleted GPS memories cannot be restored.

There are two ways to delete the memories:

- Deletes all GPS memory in a group.
- Deletes a specific memory.

Example: Deleting all in the Group F.

GPS > GPS Memory

1. Push [MENU].
2. Rotate [DIAL] to select “GPS,” then push [↵].
3. Select “GPS Memory,” then push [↵].
 - Displays the GPS MEMORY screen.
4. Select the group where the GPS memory to delete is saved, then push [QUICK].
5. Select “Delete All In Group,” then push [↵].

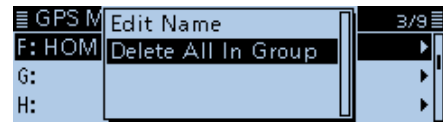

• The confirmation dialog “Delete all in group?” is displayed.

6. Select <YES>, then push [↵].

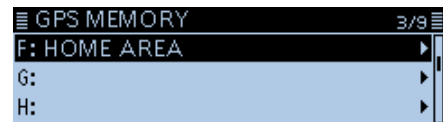
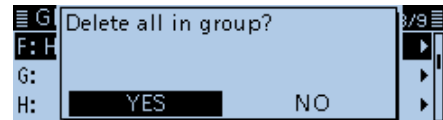

• All GPS memory in the selected group are deleted, then returns to the GPS MEMORY screen.

① When selecting a blank group, “Blank” is displayed.

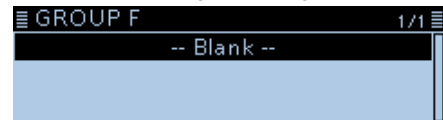

7. Push [MENU].
 - Returns to the standby screen.

Deleting a specific GPS memory

You can delete a specific GPS memory.

1. Select the GPS memory to delete, then push [QUICK].
2. Select “Delete,” then push [↵].
3. Select <YES>, then push [↵].
 - The selected GPS memory channel is deleted.

Adding or editing GPS memory (Continued)

◇ **Rearranging the display order of the GPS data**

You can move the entered GPS memories to rearrange their display order in the selected GPS memory group.

In order to move the GPS memory out of their assigned memory group, edit and move, and then save.

GPS > **GPS Memory**

1. Push [MENU].
2. Rotate [DIAL] to select "GPS," then push [↵].
3. Select "GPS Memory," then push [↵].
 - Displays the GPS MEMORY screen.
4. Select the group where the GPS memory to move is saved.
5. Select the GPS memory to move, then push [QUICK].
6. Select "Move."

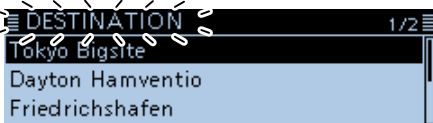
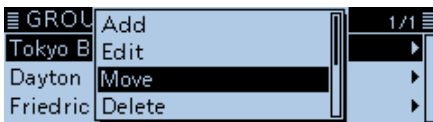

• "DESTINATION" blinks at the top left of the screen.

7. Select the location to insert the memory you want to move, then push [↵].

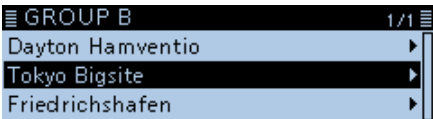
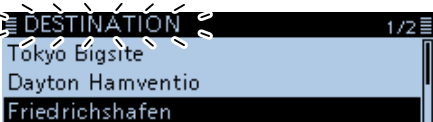

• The selected memory is inserted above the destination memory name.

① If "<<Move End>>" is selected, the memory is moved to the bottom of the group.

8. Push [MENU].
 - Returns to the standby screen.

Adding or editing GPS memory (Continued)

◇ **Setting the GPS alarm**

A GPS alarm can sound when a target location comes into the alarm area.

This function can be set to the caller station, all GPS Memory channels, a specified Memory group or a specified Memory channel.

Alarm area 1 (Setting plural stations)

When all channels or group is selected:

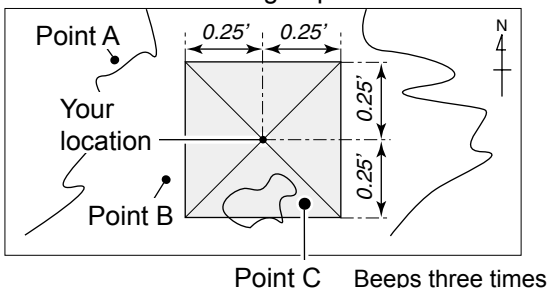

Alarm area 2 (Setting specific station)

When a specified memory is selected:

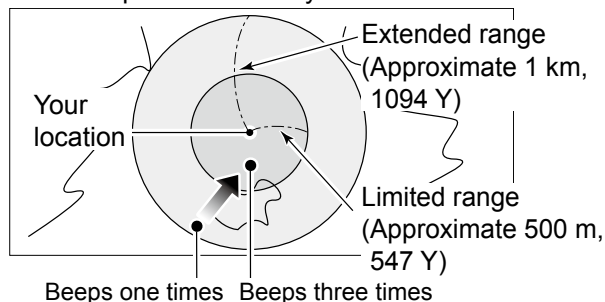

Example: Set the alarm to all GPS memory (All Memories).

GPS > GPS Alarm

1. Push [MENU].
2. Rotate [DIAL] to select “GPS,” then push [↵].
3. Select “GPS Alarm,” then push [↵].
 - Displays the GPS ALARM screen.
4. Select “Alarm Select,” then push [↵].
5. Select “Group,” then push [↵].



6. Select “All Memories,” then push [↵].



- Returns to the GPS ALARM screen.
 - ① If you want to set the alarm to a GPS memory group, select“(No Group)” or “A” to “Z.”
7. Push [MENU].
 - Returns to the standby screen, then displays “*.)”.
 - ① When either one of the stations in a specified group enters the set range, the alarm sounds three times, “GPS ALARM” pops up on the screen, and “*.)” blinks.
 - ① To cancel the GPS alarm, select “OFF” in the step 5.

When the GPS alarm sounds

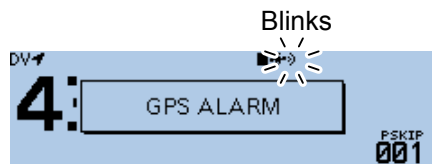

Alarm sounds, and “GPS ALARM” pops up.

TIP: When “All Memories”, “A” to “Z” or “(No Group)” is selected, the alarm sounds depending on the “Alarm Area (Group)” setting on the MENU screen. (GPS > GPS Alarm > **Alarm Area (Group)**)

Adding or editing GPS memory

◇ Setting the GPS alarm (Continued)

Example: Set the alarm setting to RX (RX/Memory).

GPS > GPS Alarm

1. Push [MENU].
2. Rotate [DIAL] to select “GPS,” then push [↵].
3. Select “GPS Alarm,” then push [↵].
 - Displays the GPS ALARM screen.
4. Select “Alarm Select,” then push [↵].
5. Select “RX,” then push [↵].



- Returns to the GPS ALARM screen.
 - ① If you want to set the alarm to a GPS memory channel, select “Memory,” and then select “(No Group)” or “A” to “Z.”
6. Push [MENU].
 - Returns to the standby screen, then displays “••).”

① Information

- When a station with its GPS alarm set enters within an approximate 1 kilometer (1093 yard) range, the alarm sounds once. When it enters within an approximate 500 meter (546 yard) range, the alarm sounds three times.
- When the GPS alarm sounds, “GPS ALARM” pops up on the screen, and “••)” blinks.
- To cancel the GPS alarm, select “OFF” in the step 5.

When the GPS alarm sounds

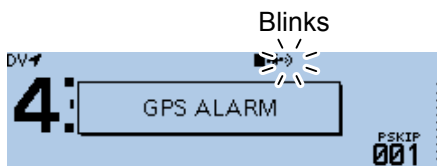

Alarm sounds, and “GPS ALARM” pops up.

NOTE: Even if “RX” is selected in step 5, when the received signal has no position data, the GPS alarm does not sound.

TIP: When “RX” or a GPS memory channel is selected, the alarm sounds depending on the “Alarm Area (RX/Memory)” setting on the MENU screen. (GPS > GPS Alarm > **Alarm Area (RX/Memory)**)

GPS Logger function

The GPS Logger function enables you to save the position data from a GPS receiver into a microSD card as a log.

The GPS Logger saves Latitude, Longitude, Altitude, Positioning state, Course, Speed and Date.

If you use this GPS Logger while driving, you can check your driving history on a mapping software.

◇ GPS Logger operating outline

To use GPS Logger function, perform following operations.

1. Insert a microSD card*.

*User supplied

2. Check whether or not the GPS receiver is receiving your position data. (p. 5-2)

3. Turn ON the GPS Logger function.



Completed! The GPS Logger function starts.

◇ GPS Logger operation

Select whether or not save your route as a log.

When the GPS Logger function is ON, the transceiver saves the position data from GPS receiver into microSD card in a specified time interval.

The saved GPS sentences are GGA, RMC, GSA and VTG.

GPS > GPS Logger > GPS Logger

1. Push [MENU].
2. Rotate [DIAL] to select "GPS," then push [↵].
3. Select "GPS Logger," then push [↵].



• Displays the GPS LOGGER screen.

4. Select "GPS Logger," then push [↵].

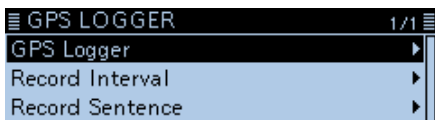

5. Select "ON," then push [↵].



6. Push [MENU].
 - Returns to the standby screen, and the GPS Logger function starts.

NOTE:

- The GPS logger function requires a microSD card (User supplied).
- Once the GPS logger function is turned ON, the transceiver continuously saves the position data from the GPS receiver, even if the transceiver is turned OFF, then ON again. To cancel this function, turn OFF the function. While this function is ON, and when the transceiver is turned OFF, the log file will be closed. Then the transceiver is turned ON and Positioning is carried out by the GPS receiver, a new log file will be created.
- When the microSD card is full, this function will be automatically paused.

◇ Setting the GPS record interval

For example, when you are walking and if the time interval is set to "1sec," a lot of position data is saved at near place. Select the GPS Logger function record interval to suit your travel speed.

(Default: 5sec)

GPS > GPS Logger > Record Interval

1. Push [MENU].
2. Rotate [DIAL] to select "GPS," then push [↵].
3. Select "GPS Logger," then push [↵].
4. Select "Record Interval," then push [↵].

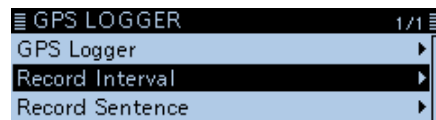

• Displays the "Record Interval" screen.

5. Select a record interval.
 - Options: Set to between 1, 5, 10, 30 and 60 seconds.



6. Push [MENU].
 - Returns to the standby screen.

GPS Logger function (Continued)

◇ **Setting the GPS record sentence**

Select the GPS sentence for the GPS Logger function. The function records only the selected sentence, so the data volume will be reduced. See the contents table shown below before selecting.

GPS > GPS Logger > **Record Sentence**

1. Push [MENU].
2. Rotate [DIAL] to select “GPS,” then push [↵].
3. Select “GPS Logger,” then push [↵].
4. Select “Record Sentence,” then push [↵].

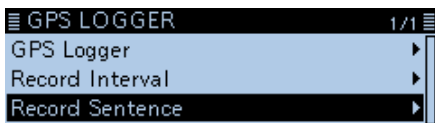

- Displays the “Record Sentence” screen.

5. Rotate [DIAL] to select the GPS sentence, then push [↵].

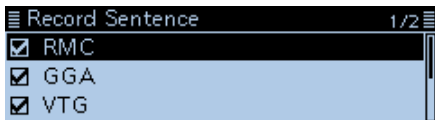

- “✓” disappears when the sentence is set to OFF.
- ① The selectable GPS sentences are RMC, GGA, VTG and GSA. All sentences are set to ON as the default.

6. Push [MENU].
 - Returns to the standby screen.

• **Contents of GPS sentence**

Sentence	Lon /Lat	Alt	UTC	Date (UTC)	Status	2D /3D	COG (True)	SOG (knot)	Others
RMC	✓		✓	✓	✓		✓	✓	Mode Indicator
GGA	✓	✓	✓		✓				Number of satellites in use, HDOP, Geoidal separation, Age of Differential GPS data
VTG							✓	✓	COG (Magnetic north), SOG (km/h), Mode Indicator
GSA					✓	✓			ID numbers of satellites used in solution, PDOP, HDOP, VDOP

GPS Logger function (Continued)

◆ Viewing the log data on a PC Map

If you want to display the your log data, copy the log file to your PC.

① Windows 10 is used for these instructions.

1. Turn OFF the transceiver, then remove the microSD card from the transceiver.
 - ① To removing the card while the transceiver power is ON, unmount it first. (See Basic manual sction 7)
2. Insert the card into the microSD card drive or a memory card reader* on your PC.
 - *User supplied.
3. Click the “Open folder to view files” option to access the card.

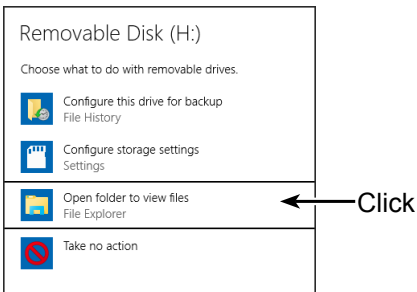

• Displays the 'ID-4100' folder.

4. Double-click the “ID-4100” folder.

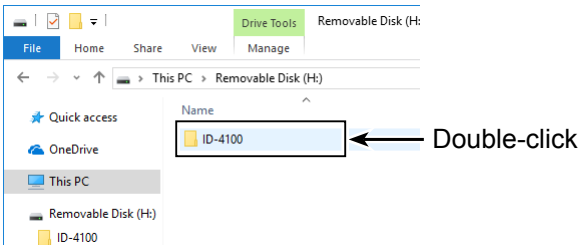

• Eight folders are displayed.

5. Double-click the “Gps” folder.

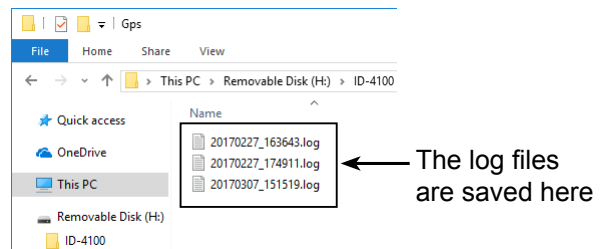
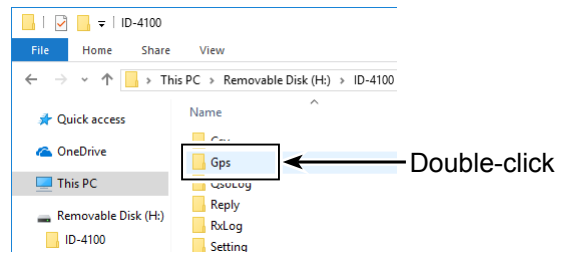

• The log files are displayed.

- ① The files are named with the time the log was started, in the following format:
 yyyyymmdd_hhmmss.log
 yyyy = year, mm = month, dd = day, hh = hour, mm = minute, ss = second

6. Import the log file to a mapping software.

- You can see your route on the software map.
- ① The file may not be compatible with all mapping software.

GPS Logger function (Continued)

For your information— About the recorded NMEA sentence for GPS logging

Regarding the GPS logging data of the ID-4100A/E, each sentence corresponds to the NMEA standard and is recorded in the following format.

◇ GGA sentence

(e.g.) \$GPGGA,161229.487,3723.2475,N,12158.3416,W,1,07,1.0,9.0,M,25.5,M,3,0000*18<CR><LF>
 ① ② ③ ④ ⑤ ⑥ ⑦ ⑧ ⑨ ⑩ ⑪ ⑫

- ① GGA protocol header (\$GPGGA)
- ② UTC of position (16:12:29.487)
- ③ Latitude (North 37° 23.2475') N=North, S=South
- ④ Longitude (West 121° 58.3416') E=East, W=West
- ⑤ GPS quality indicator (1)
0=Fix not available or invalid, 1=SPS mode
2=DGPS (SPS), 6=Estimated (Dead Reckoning) mode
- ⑥ Number of satellites in use (7), 00–12
- ⑦ Horizontal Dilution of Precision (1.0) 0.0–50.0
- ⑧ Altitude re: mean-sea-level (geoid), meters (9.0 meters)
- ⑨ Geoidal separation, meters (25.5 meters)
- ⑩ Age of Differential GPS data (3 seconds)
- ⑪ Check Sum (*18) Error detection data started with "*" (hex code)
- ⑫ End code
*Blank shows when not positioned.

◇ RMC sentence

(e.g.) \$GPRMC,161229.487,A,3723.2475,N,12158.3416,W,0.13,309.62,010417,,D*10<CR><LF>
 ① ② ③ ④ ⑤ ⑥ ⑦ ⑧ ⑨ ⑩ ⑪

- ① RMC protocol header (\$GPRMC)
- ② UTC of position (16:12:29.487)
- ③ Status (A) A=Data valid
 V=Data invalid/not positioned
- ④ Latitude (North 37° 23.2475') N=North, S=South
- ⑤ Longitude (West 121° 58.3416') E=East, W=West
- ⑥ Speed over ground (0.13 knots)
- ⑦ Course Over Ground (309.62°; degrees True)
0.00°–359.99°
- ⑧ UTC date of position ('17 Apr 1st) ddmmyy
- ⑨ Mode Indicator (D)
A=Autonomous mode, D=DGPS,
E=Estimated (dead reckoning) mode,
N=Data not valid, R=Almanac data
- ⑩ Check Sum (*10) Error detection data started with "*" (hex code)
- ⑪ End code
*Blank shows when not positioned.

◇ GSA sentence

(e.g.) \$GPGSA,A,3,07,02,26,27,09,04,, , , , ,15,1.8,1.0,1.5*33<CR><LF>
 ① ② ③ ④ ⑤ ⑥ ⑦ ⑧ ⑨

- ① GSA protocol header (\$GPGSA)
- ② Mode indicator 1 (A)
M=Manual, forced to operate in 2D or 3D mode
A=Automatic, allowed to automatically switch 2D/3D
- ③ Mode indicator 2 (3)
1=Fix not available,
2=2D (using satellites; less than 3),
3=3D (using satellites; more than 4)
- ④ ID numbers of satellites used in solution (07, 02, 26, 27, 09, 04...15)
01–32 *Shows up to 12 ID's
- ⑤ Position Dilution of Precision (1.8) 0.0–50.0
- ⑥ Horizontal Dilution of Precision (1.0) 0.0–50.0
- ⑦ Vertical Dilution of Position (1.5) 0.0–50.0
- ⑧ Check Sum (*33) Error detection data started with "*" (hex code)
- ⑨ End code
*Blank shows when not positioned.

◇ VTG sentence

(e.g.) \$GPVTG,309.62,T, ,M,0.13,N,0.2,K,A*03<CR><LF>
 ① ② ③ ④ ⑤ ⑥ ⑦ ⑧

- ① VTG protocol header (\$GPVTG)
- ② Course Over Ground (309.62°; degrees True)
0.00°–359.99°
- ③ Course over ground degrees; Magnetic north
- ④ Speed over ground, knots (0.13 knots)
- ⑤ Speed over ground, kilometer per hour (0.2 km/hr)
- ⑥ Mode Indicator (A)
A=Autonomous mode, D=DGPS,
E=Estimated (dead reckoning) mode,
N=Data not valid, R=Almanac data
- ⑦ Check Sum (*03) Error detection data started with "*" (hex code)
- ⑧ End code
*Blank shows when not positioned.

GPS Auto transmission for only Simplex

In the DV mode, this function automatically transmits the GPS receiver's current position data at a selected interval, and should only be used in the simplex mode.

- ① Your own call sign must be entered to activate the GPS automatic transmission.
 - ① When "GPS TX Mode" is set to "NMEA," be sure to set "GPS Select" to "Internal GPS" or "External GPS."
- When "GPS TX Mode" is set to "D-PRS," and "TX Format" is set to "Position" or "Weather," be sure to set "GPS Select" to "Internal GPS," "External GPS," or "Manual."
- Otherwise, you cannot use this function.
 (GPS > GPS Set > **GPS Select**) (p. 9-24)

◇ Setting the GPS automatic transmission

GPS > GPS Logger > **GPS Auto TX**

1. Push [MENU].
2. Rotate [DIAL] to select "GPS," then push [↵].
3. Select "GPS Auto TX," then push [↵].



4. Select the position data transmit interval.

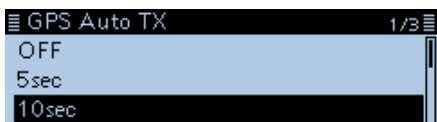

- Options: Set to between OFF, 5, 10, 30 seconds, or 1, 3, 5, 10, and 30 minutes. (Default: OFF)

① **Information**

- Selecting "OFF" cancels the GPS automatic transmission.
- If four GPS sentences are selected in "GPS Sentence," "5sec" cannot be selected.
- The GPS message is also transmitted, if entered.

5. Push [MENU].
 - Returns to the standby screen.

NOTE:

- Use GPS automatic transmission in only the simplex mode.
- GPS automatic transmission through a repeater may interfere with other communications. When a GPS message is entered, the transceiver transmits it along with the position data. See page 5-26 for the GPS message entry.

Section 6

USING A microSD CARD

Saving data onto a microSD card.....	6-2
Saving the setting data onto a microSD card	6-3
Saving with a different file name.....	6-4
Loading the saved data files that are on the microSD card....	6-5
Backing up the data saved on the microSD card onto a PC ..	6-6
◇ About the microSD card's folder contents.....	6-6
◇ Making a backup file on your PC	6-7
Importing or Exporting a CSV format file	6-8
◇ Importing	6-8
◇ Exporting.....	6-9

Saving data onto a microSD card

You can save the following data onto the card:

- **Data settings of the transceiver**

Memory channel contents, repeater lists, Your (UR) memory and GPS memories that are saved in the transceiver.

- **Communication contents**

Communication audio.

- **Communication log**

The communication and RX history logs.

- **Automatic answering voice audio for the DV mode**

Voice audio used for the Auto Reply function in the DV mode.

- **Voice audio for the Voice TX function**

Voice audio for the Voice TX function to be used in amateur radio contests, and so on.

- **GPS position data**

GPS position data that is saved as tracking data.

Saving the setting data onto a microSD card

You can save the Memory channels, Menu screen item settings, and repeater lists on a microSD card. Saving data settings on a card enables you to easily restore the transceiver to its previous settings, even if you perform an All Reset.

TIP: The setting data are saved in the “icf” file format that is used in the CS-4100 CLONING SOFTWARE. When the saved data on a card is copied to a PC, you can edit it with the cloning software.

You can save the setting data as a new file or to overwrite an older file.

To save as a new file

SD Card > **Save Setting**

1. Push [MENU].
2. Rotate [DIAL] to select “SD Card,” then push [↵].
3. Select “Save Setting,” then push [↵].
4. Select “<<New File>>,” then push [↵].

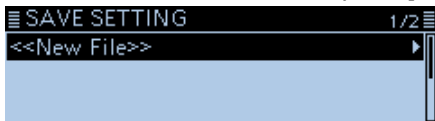

- Displays the FILE NAME screen.
- ① The file name is automatically named in the following manner: Setyyyyymmdd_xx (yyyy: Year, mm: month, dd: day, xx: serial number)
Example: If a second file is saved on April 1, 2017, the file is named “Set20170401_02.”
- ① To change the file name, see “Save with a different file name.” (p. 6-4)

5. Push [↵].

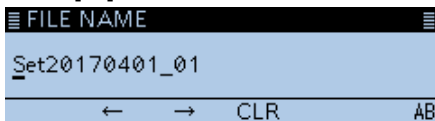

- The confirmation dialog “Save file?” is displayed.

6. Select <YES>, then push [↵].



- Saves the data settings.
- ① While saving, a progress bar is displayed, then returns to the SD CARD screen after the saving is completed.

7. Push [MENU].
 - Returns to the standby screen.

To overwrite a file

To overwrite a file, select the file to be overwritten in step 4 to the left.

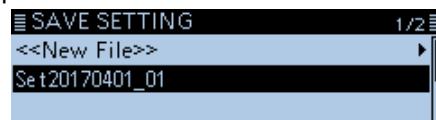

Saving with a different file name

SD Card > Save Setting

1. Push [MENU].
2. Rotate [DIAL] to select "SD Card," then push [↵].
3. Select "Save Setting," then push [↵].
4. Select "<<New File>>," then push [↵].

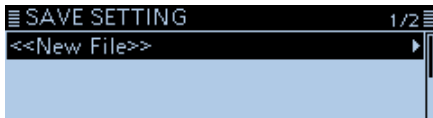

- Displays the FILE NAME screen.
5. Push [RX→CS].
 - Deletes the entered characters.
 - ① If [RX→CS] is continuously held down, the characters are continuously deleted.
 6. Enter a name of up to 20 characters.
(Example: My data)

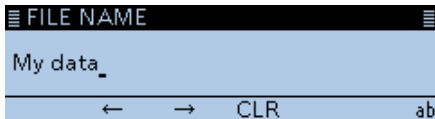

Selectable characters and symbols

A to Z, a to z, 0 to 9, ! " # \$ % & ' () + , -
 . = ? @ [\] ^ _ ` { | } ~ (space)

- ① See "Entering and editing text" for details. (p. iv)
7. After entering, push [↵].
 - The confirmation dialog "Save file?" is displayed.
 8. Select <YES>, then push [↵].

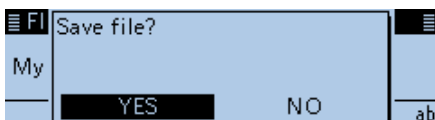

- Saves the data settings.
 - ① While saving, "SAVING" and a progress bar are displayed, then returns to the SD CARD screen after the saving is completed.
9. Push [MENU].
 - Returns to the standby screen.

Loading the saved data files that are on the microSD card

Memory channels, Menu screen item settings, and repeater lists can be copied to the transceiver. This function is convenient when copying saved data, such as memory channels, or repeater lists, to another ID-4100A/E, and then operating with the same data.

TIP: Saving the current data is recommended before loading other data into the transceiver.

(Example: Loading all the data into the "Set20170401_01" file)

SD Card > Load Setting

1. Push [MENU].
2. Rotate [DIAL] to select "SD Card," then push [↵].
3. Select "Load Setting," then push [↵].
4. Select a file to load.

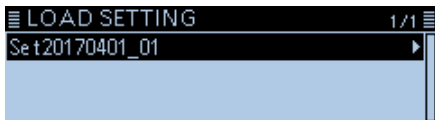

- Displays the LOAD SETTING screen.
5. Select the loading option, then push [↵].
 - ALL: Loads all memory channels, Menu screen item settings and the repeater list into the transceiver.
 - Except My Station: Loads all memory channels, Menu screen item settings and the repeater list except MY call signs and TX message into the transceiver.
 - Repeater List Only: Loads only the repeater list into the transceiver.

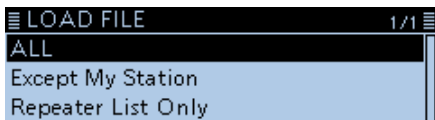

- The confirmation dialog "Keep 'SKIP' settings in the Repeater List?" is displayed.
6. Select <YES>, <NO> or <Cancel>, then push [↵].
 - YES: Retains the skip settings of the repeater list. (p. 4-40)
 - NO: Does not retain the skip settings of the repeater list.
 - Cancel: Returns to the LOAD FILE screen.

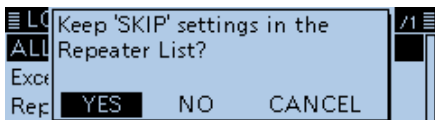

- When you select <YES> or <NO>, the confirmation dialog "Load file?" is displayed.

7. Select <YES>, then push [↵].

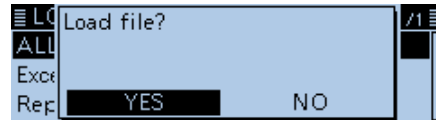

- Starts the file check.
- ① While checking the file, displays "CHECKING FILE" and a progress bar.



8. After checking, settings data loading begins.
 - ① While loading, "LOADING" and a progress bar are displayed.

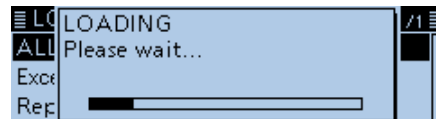

9. After loading ends, "COMPLETED!" is displayed.
 - ① To complete the loading, restart the transceiver.

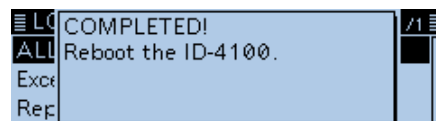

Backing up the data saved on the microSD card onto a PC

A backup file enables easy restoration, even if the data on the microSD card is accidentally deleted.

① If your PC does not have a microSD card slot, connect a memory card reader (user supplied) to use the microSD card.

◆ About the microSD card's folder contents

The folder in the microSD card contains the following:

1. **ID-4100 folder**
Contains the folders created in the ID-4100.
2. **Csv folder**
Contains the GPS Memory, Repeater List and Your Call Sign Memory folders.
3. **GpsMemory folder**
Saves the Gps Memory in the "csv" format to import.
4. **RptList folder**
Saves the Repeater List in the "csv" format to import.
5. **YourMemory folder**
Saves the Your Call Sign Memory in the "csv" format to import.
6. **Gps folder**
Saves GPS logging data in the "log" format.
7. **QSOLog folder**
Saves QSO log data in the "csv" format.
8. **Reply folder**
Saves Automatic reply data in the "wav" format.
9. **RxLog folder**
Saves RX record log data in the "csv" format.
10. **Setting folder**
Saves the transceiver's setting data in the "icf" format.
11. **Voice folder**
Creates the recorded QSO audio date folders.
12. **yyyyymmdd folder**
Saves the recorded audio file in the "wav" format. The folder name is automatically created in the following format:
yyyyymmdd (yyyy:year, mm:month, dd:day)
13. **VoiceTx folder**
Saves the recorded voice audio data for the Voice TX function in the "wav" format.

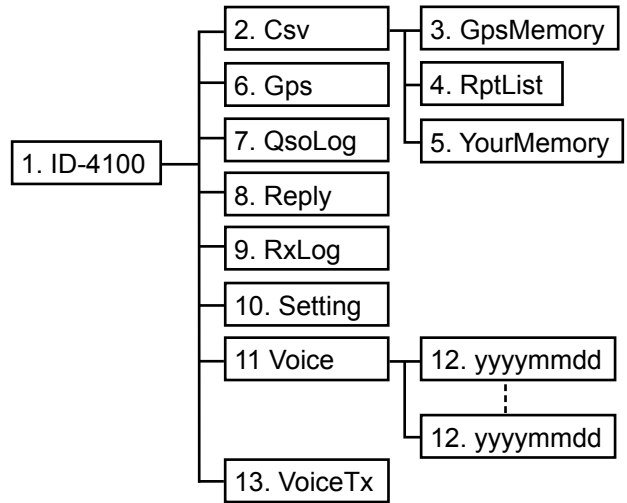

(Example: Selecting the setting data)
When the microSD card is inserted into the microSD card slot of your PC or the microSD card reader, the screen is displayed as shown below.

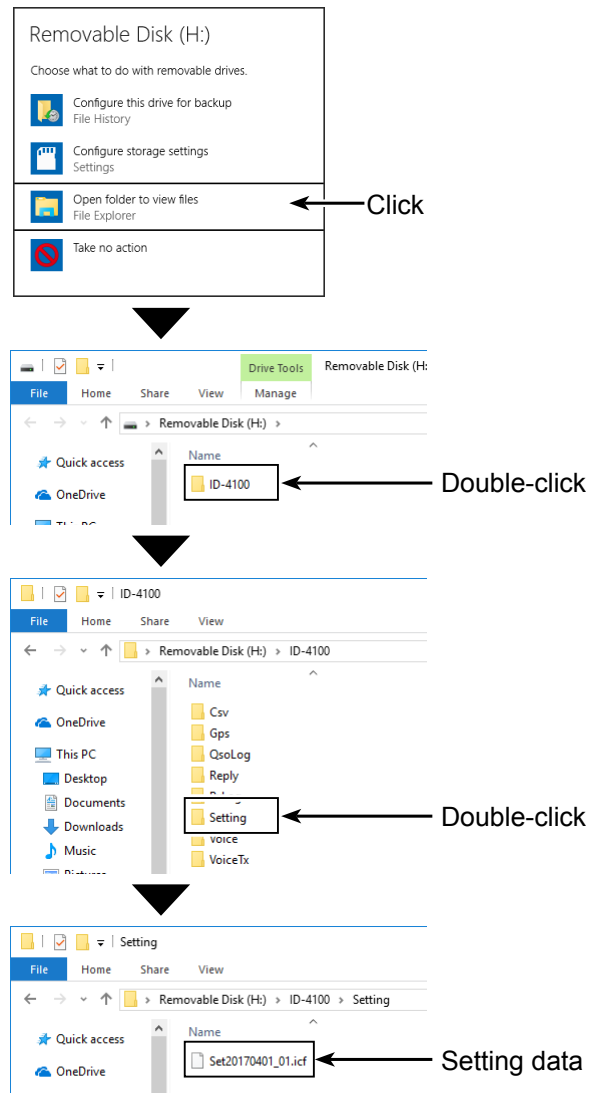

Backing up the data saved on the microSD card onto a PC (Continued)

◆ Making a backup file on your PC
Windows® 10 is used for these instructions.

1. Insert the microSD card into the microSD card drive or a memory card reader* on your PC.
*User supplied.
2. Click the “Open folder to view files” option to access the card.

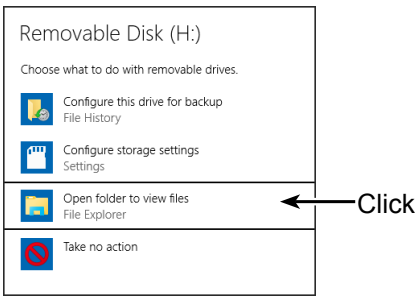

• Displays the ‘ID-4100’ folder.

3. Right-click “Removable disk.”
4. Click “Copy.”

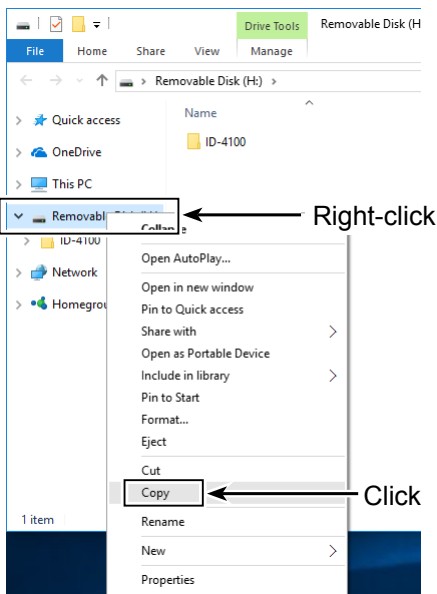

5. Open a folder to copy a backup file to, then right-click, and then click “Paste.”
• Copies the microSD card data onto your hard disk.
(Example: Copying into the “Backup” folder on the C drive)

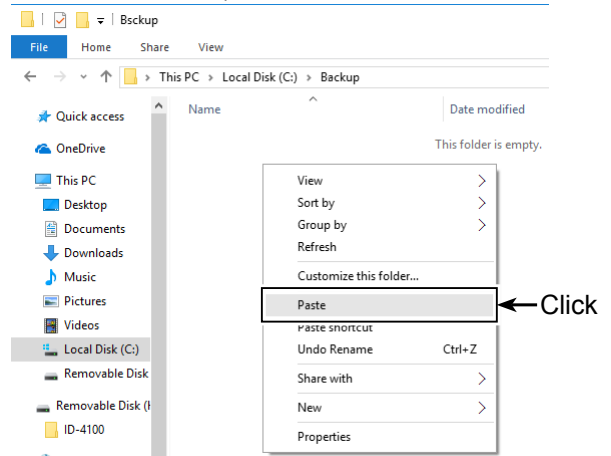

6. To remove the microSD card, click the removable disk icon (“Eject” in the screen shot shown below) in the task bar. Then, click “Eject Removable Disk.”

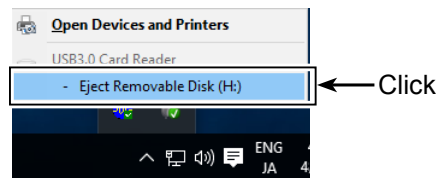

(When a memory card reader is connected.)

7. When “Safe To Remove Hardware” is displayed, remove the microSD card.

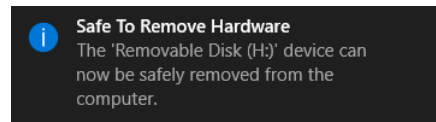

(When a memory card reader is connected.)

Importing or Exporting a CSV format file

Please read this section before importing or exporting a Comma Separated Values (CSV) format file from the microSD card.

You can import or export the following data:

- Your Call Sign Memory
- Repeater List
- GPS Memory

◇ Importing

NOTE:

- Before importing, make a backup file of all the transceiver’s data to the microSD card in case of data loss.
- The transceiver cannot display a file that has a file name longer than 21 characters. In this case, rename it using 20 characters or less. When you export the data in a CSV format file using the CS-4100, BE SURE to name it using 20 characters or less.

Example: Importing the Your Call sign memory.

SD Card > Import/Export > **Import**

1. Push [MENU].
2. Rotate [DIAL] to select “SD Card,” then push [↵].
3. Select “Import/Export,” then push [↵].
4. Select “Import,” then push [↵].
5. Select “Your Call Sign,” then push [↵].



6. Select the CSV file to import.

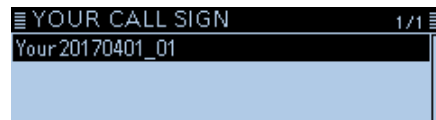

- The confirmation dialog “Import file?” is displayed.

7. Select <YES>, then push [↵].

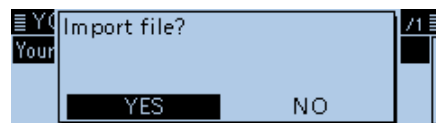

- Starts to import.
- ① While importing, “IMPORTING” and a progress bar are displayed.
- ① After importing ends, “COMPLETED!” is displayed.
- ① To complete the importing, restart the transceiver.

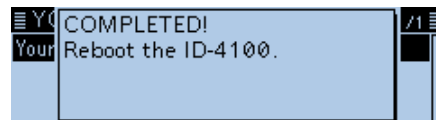

TIP: To import a repeater list, see the step 6 on page 6-5 for details.

Importing or Exporting a CSV format file (Continued)

◇ **Exporting**

You can export Your Call Sign Memory, Repeater List and GPS Memory.

To save as a new file

Example: Exporting the Your Call sign memory.

To overwrite a file

To overwrite a file, select the file to be overwritten in step 6 to the left.

SD Card > Import/Export > **Export**

1. Push [MENU].
2. Rotate [DIAL] to select "SD Card," then push [↵].
3. Select "Import/Export," then push [↵].
4. Select "Export," then push [↵].
5. Select "Your Call Sign."



6. Select "<<New File>>."



- Displays the FILE NAME screen.
- ① The file name is automatically named in the following manner; Your*yyyymmdd_xx (yyyy: Year, mm: month, dd: day, xx: serial number)
* "Rpt" is displayed for a repeater list, and "Gps" is displayed for a GPS memory.
- ① To change the file name, see "Save with a different file name." (p. 6-4)

7. Push [↵].

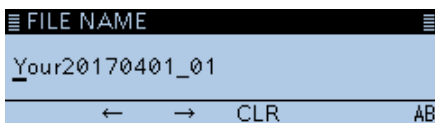

- The confirmation dialog "Export file?" is displayed.

8. Select <YES>, then push [↵].

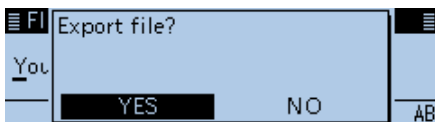

- Exports the data settings.
- ① While exporting, "EXPORTING" and a progress bar are displayed.

9. Push [MENU].
• Returns to the standby screen.

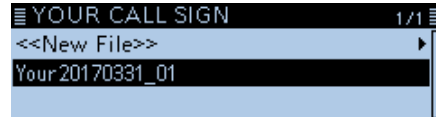

Section 7 VOICE MEMORY

Recording a QSO audio	7-2
Playing back the recorded audio	7-3
Changing the QSO recorder settings	7-4
Deleting the audio folder/file	7-5
◇ Delete an Audio Folder	7-5
◇ Delete an Audio File.....	7-5
Viewing the file information.....	7-6
Viewing the microSD card memory capacity	7-7
Playing back the recorded audio on the PC	7-8

Recording a QSO audio

NOTE:

- Be sure to insert a microSD card into the transceiver before recording the audio.
- Once the recording has started, it will continue, even if the transceiver is restarted.

To starting to record

1. Push [QUICK].
2. Rotate [DIAL] to select “<<REC Start>>,” then push [↵].

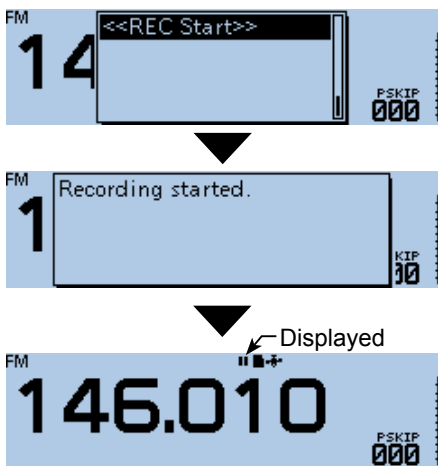

Recording Standby mode

To stop recording

1. Push [QUICK].
2. Rotate [DIAL] to select “<<REC Stop>>,” then push [↵].

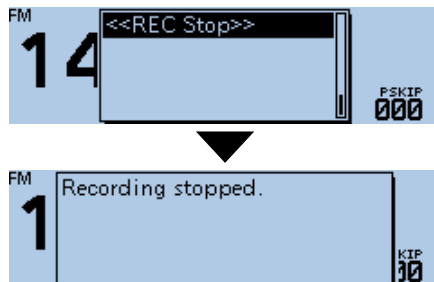

The recording starts when you transmit or the squelch opens.



Information

- The recording pauses while no signal is received, and resumes when a signal is received again.
- The recording continues until you manually stop recording, or the card becomes full.
- If the recording file’s content reaches 2GB, the transceiver automatically creates a new file, and continues recording.

TIP: When the PTT Automatic Recording function is set to ON, the recording automatically starts when “<<REC Start>>” is selected. In that case, recording continues even while no signal is received. See page 7-4 for details.
 (Voice Memo > QSO Recorder > Recorder Set > **PTT Auto REC**)

Playing back the recorded audio

NOTE: Insert the microSD card, which contains the recorded audio file, into the transceiver's slot.

Voice Memo > QSO Recorder > Play Files

1. Push [MENU].
2. Rotate [DIAL] to select "Voice Memo," then push [↵].



3. Select "QSO Recorder," then push [↵].

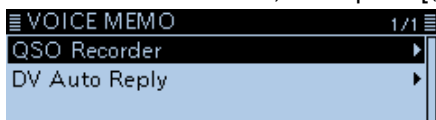

4. Select "Play Files," then push [↵].

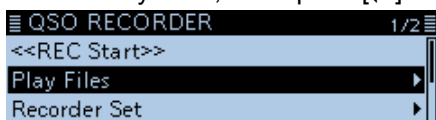

- Displays the recorded file folders.

5. Select the folder that contains the audio file to play, then push [↵].



① The folder name is automatically named in the following manner: yyyyymmdd (yyyy: year, mm: month, dd: day)

6. Select the audio file to play.
 - The VOICE PLAYER screen is displayed, and the file starts to play.

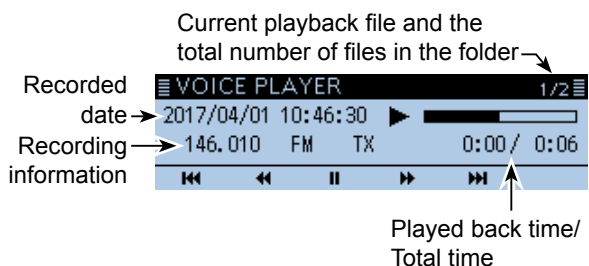
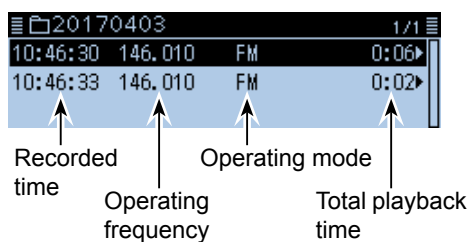

The VOICE PLAYER screen description

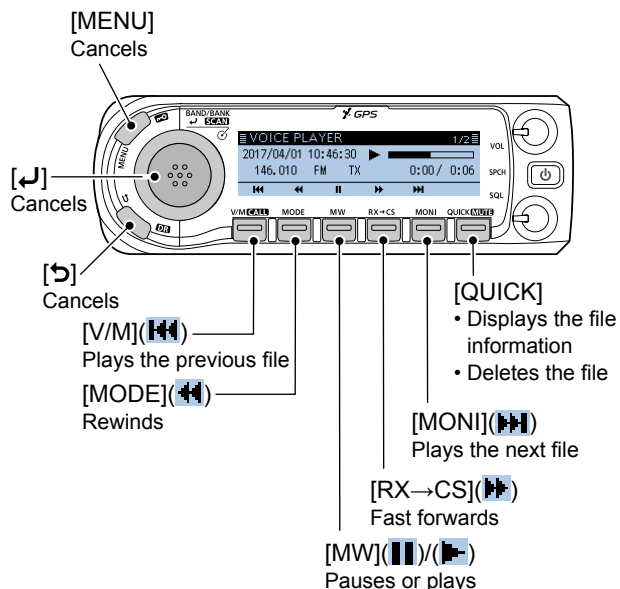

Fast forward/Rewind

- Hold down [RX→CS] (⏭) or [MODE] (⏪) for 1 second to continuously fast forward/rewind the file.
- The default skip time is 10 seconds. If you want to change it, see page 7-4 for details.
- You can fast forward or rewind the file that is playing by rotating [DIAL]. The fast forward/rewind time is 1/20 of the total file time, regardless of the skip time setting.

Rewind while playing

If you push [MODE] (⏪) within the first one second of the file, the skip time at the end of the previously recorded file will playback.

Playing the previous file

- While the oldest file in the folder is playing back, push [V/M] (⏮) to start playing the file at the beginning.
- When the playback is paused at the beginning of a file, push [V/M] (⏮) to move to the beginning of the previous file, and pause.

Playing the next file

- While the latest file in the folder is playing back, push [MONI] (⏩) to stop playing.
- When the playback is paused, push [MONI] (⏩) to move to the beginning of the next file, and pause.

Operating information

The operating frequency, mode, and audio category (received audio or transmitted audio) is also recorded as the operating information.

Changing the QSO recorder settings

You can change the recording setting on the MENU screen.

See page 9-21 for details.

Record only the received audio

Voice Memo > QSO Recorder > Recorder Set > **REC Mode**



- ① The default setting is "TX&RX" (Both transmitted and received audio are recorded).

Continue to record even while the squelch is closed

Voice Memo > QSO Recorder > Recorder Set > **RX REC Condition**

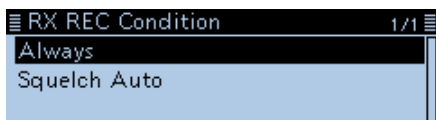

- ① The default setting is "Squelch Auto" (Records only while the squelch is open).

Record the QSO audio as one file

Voice Memo > QSO Recorder > Recorder Set > **File Split**



- ① The default setting is "ON" (transmitted and received audio are separately recorded in different files).
- ① When "RX REC Condition" is set to "Squelch Auto," an audio file is created every time the squelch opens. The received audio is recorded in a separated file.

Synchronize the recording to PTT

Voice Memo > QSO Recorder > Recorder Set > **PTT Auto REC**

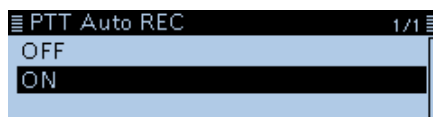

- ① The default setting is "OFF" (Recording is not synchronized to PTT.).

TIP: When "PTT Auto REC" is set to "ON"

- Starts recording not only when PTT is pushed, but also when switched to transmit by the CI-V command.
- When "REC Mode" is set to "RX Only," the transmit audio is not recorded.
- A signal that is received within 10 seconds after the squelch is closed is recorded in same file.

Change the Skip Time

Voice Memo > QSO Recorder > Player Set > **Skip Time**



- ① The default setting is "10sec."

Deleting the audio folder/file

NOTE: A deleted audio file can NOT be recovered.

◇ Delete an Audio Folder

NOTE: All audio files in the folder are deleted.

Voice Memo > QSO Recorder > Play Files

1. Push [MENU].
2. Rotate [DIAL] to select “Voice Memo,” then push [↵].



3. Select “QSO Recorder,” then push [↵].

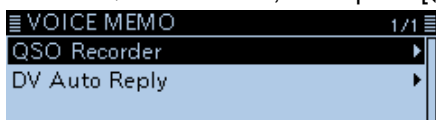

4. Select “Play Files,” then push [↵].

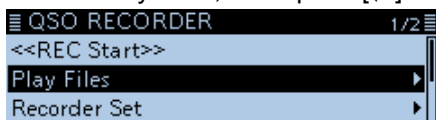

• Displays the recorded file folders.

5. Select the folder to delete.



6. Push [QUICK].

7. Select “Delete,” then push [↵].

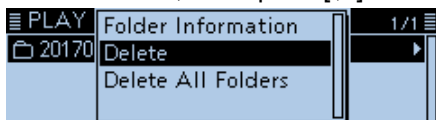

• The confirmation dialog “Delete folder?” is displayed.

8. Select <YES>, then push [↵].

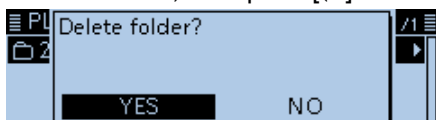

• A beep sounds, and then the folder is deleted.

9. Push [MENU].

• Returns to the standby screen.

TIP: To delete all folders

Select “Delete All Folders” in step 7.

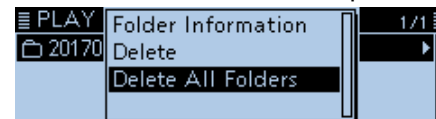

◇ Delete an Audio File

Voice Memo > QSO Recorder > Play Files

1. Push [MENU].
2. Rotate [DIAL] to select “Voice Memo,” then push [↵].
3. Select “QSO Recorder,” then push [↵].
4. Select “Play Files,” then push [↵].
 - Displays the recorded file folders.
5. Select the folder that contains the audio file to delete, then push [↵].



6. Select the audio file to delete.

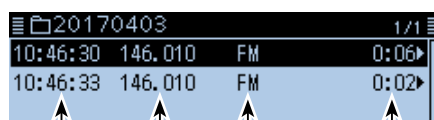

7. Push [QUICK].

8. Select “Delete,” then push [↵].

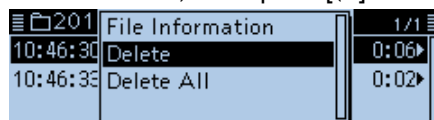

• The confirmation dialog “Delete file?” is displayed.

9. Select <YES>, then push [↵].

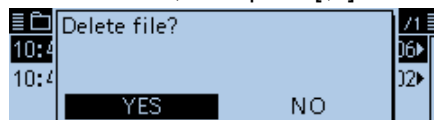

• A beep sounds, and then the folder is deleted.

10. Push [MENU].

• Returns to the standby screen.

TIP: To delete all files

Select “Delete All” in step 8.

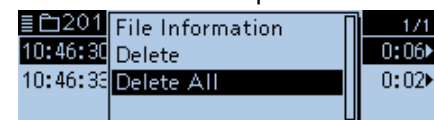

Viewing the file information

The recorded audio file contains the recording data (operating frequency, operating mode, recorded date, and so on).

Voice Memo > QSO Recorder > Play Files

1. Push [MENU].
2. Rotate [DIAL] to select "Voice Memo," then push [↵].
3. Select "QSO Recorder," then push [↵].
4. Select "Play Files," then push [↵].
 - Displays the recorded file folders.
5. Select the folder that contains the file to view the information, then push [↵].



6. Select the audio file to view the information.

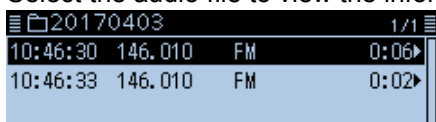

7. Push [QUICK].
8. Select "File Information," then push [↵].

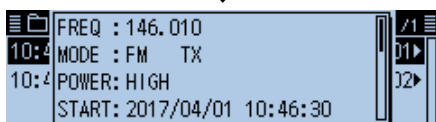
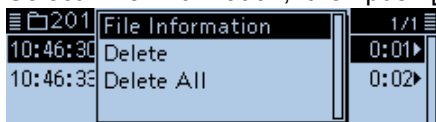

• Displays the File Information window.

9. Push [MENU].
10. Returns to the screen selected in step 6.

TIP: To view the folder information

Push [QUICK] in step 5, and then select "Folder Information" to view the folder information.

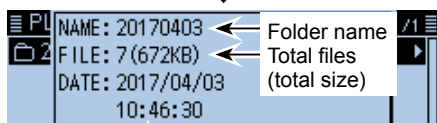
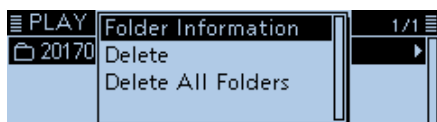

Created date

File information examples

- ① Depending on the recording status, some data may not be displayed.
- ② The file name is automatically named in the following manner: yyymmdd_hhmmss (yyyy: year, mm: month, dd: day, hh: hour, mm: minute, ss: second)

• TX audio file information

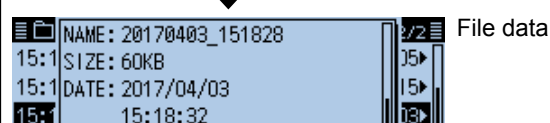
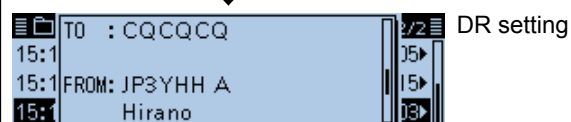
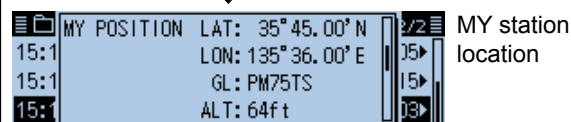
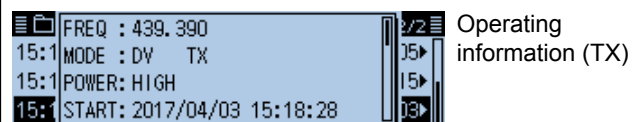

• RX audio file information

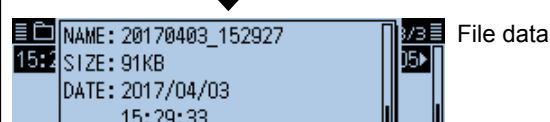
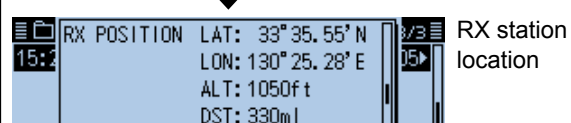
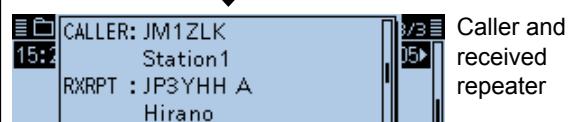
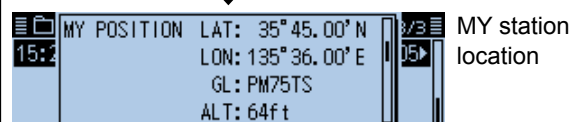
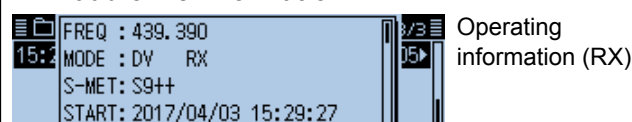

Viewing the microSD card memory capacity

You can check the microSD card memory capacity and available recording time.

SD Card > SD Card Info

1. Push [MENU].
2. Rotate [DIAL] to select "SD Card," then push [↵].

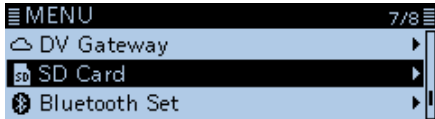

3. Select "SD Card Info," then push [↵].

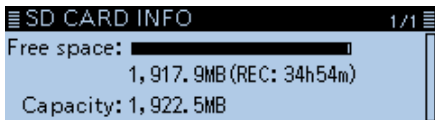
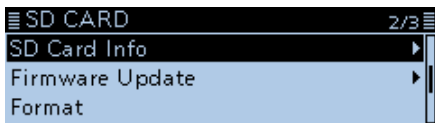

- Displays the remaining capacity and available recording time.
4. Push [MENU].
 - Returns to the standby screen.

Playing back the recorded audio on the PC

You can play back the recorded QSO audio on your PC.

① Operation data is not displayed.

Windows 10 is used for these instructions.

Example: Playing back the audio file on the microSD card on the PC, through the memory card reader (user supplied).

1. Insert the microSD card into a memory card reader on your PC.
2. Click the "Open folder to view files" option to access the card.

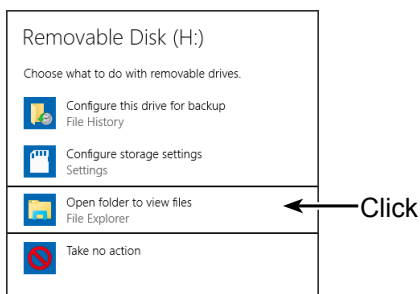

3. Double-click the 'ID-4100' folder.

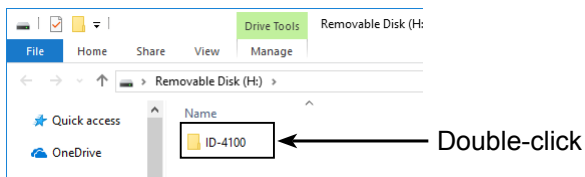

4. Double-click the 'Voice' folder.

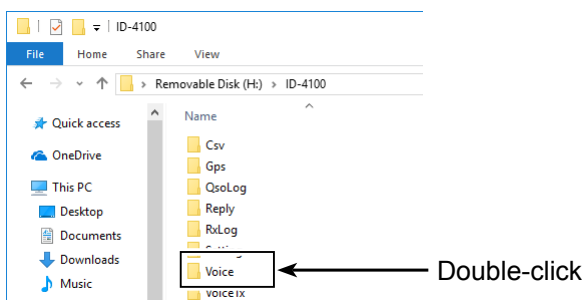

5. Double-click the folder that contains the audio file to play back. (Example: "20170403")

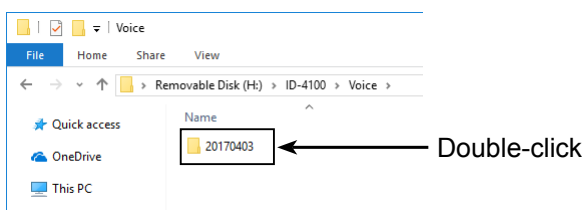

6. Double-click the file to play back. (Example: "20170403_104630.wav")

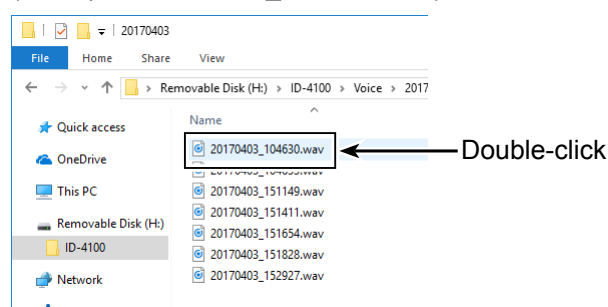

① Information

- See the instruction manual of your player for operation details.
- The audio file may not play back, depending on the player.

Section 8

REPEATER AND DUPLEX OPERATIONS

FM Repeater operation.....	8-2
◇ Checking the repeater input signal	8-3
◇ 1750 Hz tone burst	8-3
Duplex operation	8-4
◇ Setting the frequency offset	8-4
◇ Setting the duplex direction	8-4
◇ Duplex operation.....	8-4
Off band indication.....	8-5
Auto repeater function	8-5

FM Repeater operation

A repeater receives signals and on one frequency, and then retransmits them on a different frequency. When using a repeater, the transmit frequency is shifted from the receive frequency by a frequency offset.

A repeater can be accessed using the Duplex function by setting the transceiver's offset to the same value as the repeater's offset.

See Section 4 for details on accessing a D-STAR repeater.

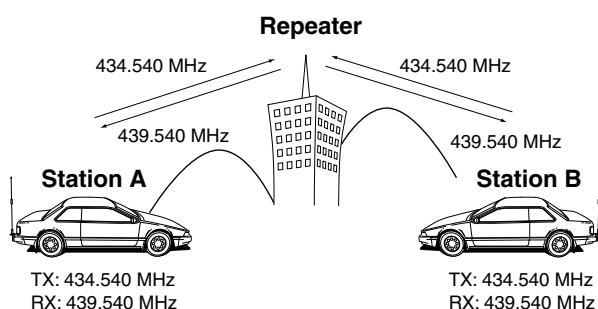

1. Push [V/M] several times until you enter the VFO mode.
2. Push [BAND].
 - Enters the Band Select mode.
3. Rotate [DIAL] to select the operating band.
4. Push [BAND] again.
 - Returns to the frequency display.
5. Push [MODE] several times until you select the FM mode.
6. Rotate [DIAL] to set the receive frequency (Repeater output frequency).
 - ① When the Auto Repeater function (usable in only the USA version) is turned ON, skip steps 7 ~ 12. (p. 8-5)
7. Push [QUICK].
8. Rotate [DIAL] to select "DUP," then push [↵].

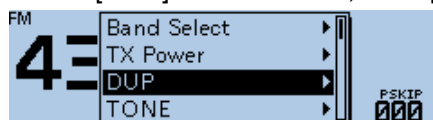

• Displays the Duplex direction setting window.

9. Select the offset direction, then push [↵].

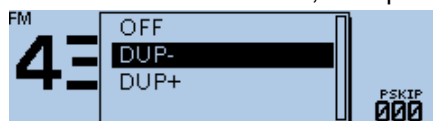

• Displays "D-" or "D+."

① You can set the frequency offset in the MENU screen. (DUP/TONE... > **Offset Freq**) (p. 9-16)

10. Push [QUICK].
11. Select "TONE," then push [↵].

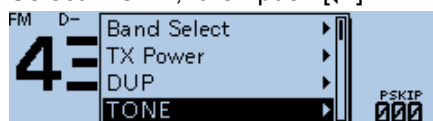

• Displays the Tone function setting window.

12. Select "TONE," then push [↵].

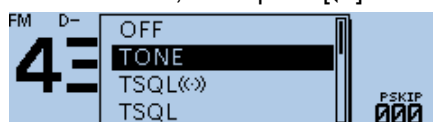

• Turns ON the repeater tone, and "TONE" is displayed.

① You can set the tone frequency in the MENU screen. (DUP/TONE... > **Repeater Tone**) (p. 9-16)

13. Operate in the normal way.
 - ① Subaudible tone is superimposed on your transmit signal.

TIP:

- When the Repeater tone frequency or the frequency offset is changed, the tone or offset for Auto Repeater function is also changed.
- If the offset value will cause the transmit frequency to be out of the band, "OFF BAND" is displayed on the display when [PTT] is pushed, and transmit will be inhibited. (p. 8-5)

FM Repeater operation (Continued)

◇ **Checking the repeater input signal**

You can check whether another station's transmit signal can be received directly or not, by listening to the repeater input frequency.

1. Push [MONI] to listen on the repeater input frequency.
 - While monitoring, "BUSY" blinks.

① **Information**

- While monitoring, the displayed frequency automatically changes to the transceiver transmit frequency (repeater input frequency).
- When the other station's signal can be directly received, move to a non-repeater frequency and use simplex. (duplex OFF)
- While monitoring, the Attenuator function is temporarily disabled to receive a weak signal.

2. Push [MONI] again to cancel monitoring.

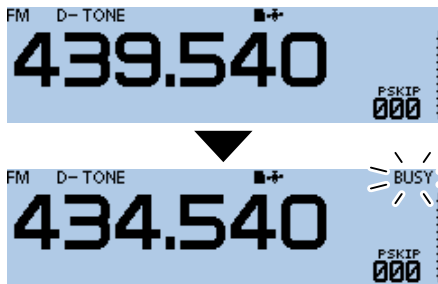

While monitoring

◇ **1750 Hz tone burst**

A 1750 Hz tone is required to access many European repeaters.

① This operation is only for the ID-4100E.

1. Push [MODE] several times until you select the FM mode.
2. While holding down [PTT] on the microphone to transmit, push [T-CALL] if assigned to a microphone key.
 - Accesses the repeater with a short tone burst.
 - Displays "1750Hz TONE."



Sending the tone burst

3. Operate in the normal way.

Duplex operation

The Duplex operation shifts the transmit frequency up or down from the receive frequency by an offset amount.

◇ Setting the frequency offset

NOTE: The frequency offset cannot be changed when using the DR function.

DUP/TONE... > Offset Freq

1. Push [MENU].
2. Rotate [DIAL] to select “DUP/TONE...,” then push [↵].

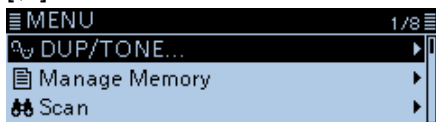

3. Select “Offset Freq,” then push [↵].

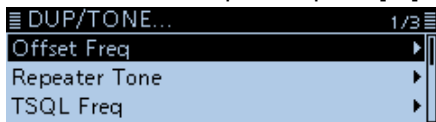

4. Rotate [DIAL] to set the offset.
(Example: 0.700.00 MHz)

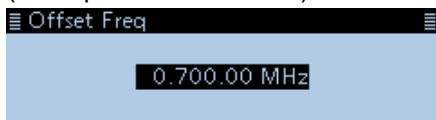

- ① Set to between 0.000.00 and 59.99500 MHz.
- ① The selected tuning step in the VFO mode is used to set the offset.

5. Push [↵] to set the offset.
6. Push [MENU].
 - Returns to the standby screen.

TIP: If the offset value will cause the transmit frequency to be out of the band, “OFF BAND” is displayed on the display when [PTT] is pushed, and transmit will be inhibited. (p. 8-5)

◇ Setting the duplex direction

1. Push [QUICK].
2. Rotate [DIAL] to select “DUP,” then push [↵].
3. Select the offset direction, then push [↵].
 - OFF: For simplex operation (the receive and transmit frequencies are the same).
 - DUP-: The transmit frequency shifts down from the receive frequency by the offset amount.
 - DUP+: The transmit frequency shifts up from the receive frequency by the offset amount.

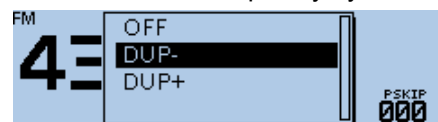

- Displays “D-” or “D+.”

◇ Duplex operation

1. Push [MONI] to listen to the transmit frequency to check whether another station is transmitting on it, or not.
 - The transceiver transmit frequency is displayed on the display.
2. Push [MONI] again to cancel monitoring.
3. Operate in the normal way.

NOTE: When the Auto repeater is ON, and the operating frequency is set out of the repeater output frequency range, the duplex mode is automatically cancelled.

Off band indication

If the transmit frequency is out of the amateur band, the off band indication, "OFF BAND," is displayed on the display when [PTT] is pushed. Check the frequency offset or duplex direction in this case. (p. 8-2)

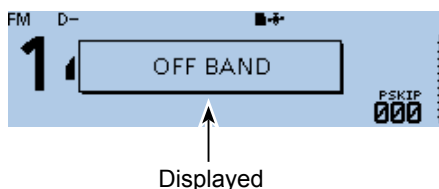

Auto repeater function

When the operating frequency falls within the repeater output frequency range, the Auto Repeater function automatically sets the repeater settings (duplex ON/OFF, duplex direction, tone encoder ON/OFF). The Auto Repeater function uses the preset repeater tone frequency and frequency offset.

NOTE for the USA version transceiver:

When turned ON, the Auto Repeater function has priority over the manual duplex setting. If the transmit frequency changes after setting, the Auto Repeater function may have changed the duplex setting.

Function > Auto Repeater

1. Push [MENU].
2. Rotate [DIAL] to select "Function," then push [↵].
3. Select "Auto Repeater," then push [↵].
4. Select the option to turn ON the Auto Repeater function.
 - OFF: Turn OFF the function.
 - ON (DUP): Turns ON only the duplex operation. (Default)
 - ON (DUP, TONE): Turns ON the duplex operation and tone encoder.
5. Push [MENU].
 - Returns to the standby screen.

Frequency range and offset direction

Frequency range	Shift direction
145.200 ~ 145.495 MHz	"DUP-" is set
146.610 ~ 146.995 MHz	"DUP-" is set
147.000 ~ 147.395 MHz	"DUP+" is set
442.000 ~ 444.995 MHz	"DUP+" is set
447.000 ~ 449.995 MHz	"DUP-" is set

Selecting a Menu item.....	9-2
◇ MENU screen operation	9-2
Menu items and Default settings	9-3
DUP/TONE items	9-16
Manage Memory items.....	9-17
Scan items.....	9-18
Voice Memo items (For Record/Playback).....	9-21
Voice TX items.....	9-23
GPS items	9-24
Call Sign items.....	9-41
RX History items.....	9-42
DV Memory items	9-45
My Station items.....	9-47
DV Set items.....	9-48
SPEECH items	9-51
DTMF items	9-53
QSO/RX Log items	9-54
Function items	9-57
Display items	9-62
Sounds items.....	9-66
Time Set items.....	9-67
DV Gateway items.....	9-67
SD Card items	9-68
Bluetooth® Set items.....	9-69
Others items	9-73

Selecting a Menu item

You can use the MENU screen to set infrequently changed values or function settings. In addition to this page, see pages 9-3 through 9-15 for details of each item's options and their default value.

TIP: The MENU screen is constructed in a tree structure. You may go to the next tree level, or go back a level, depending on the selected item.



◇ MENU screen operation

[MENU]
Switches between the MENU screen and the standby screen.

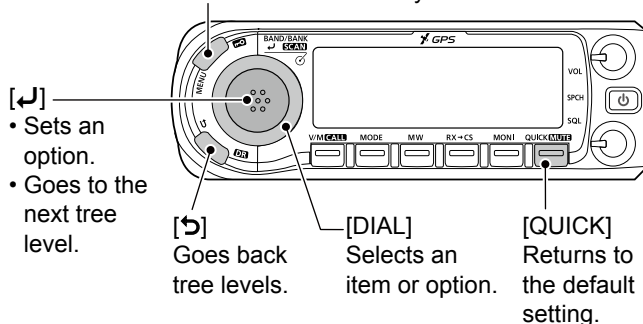

Simplified description—'Select' operation

In this manual, user's 'Select' operation is simplified, as shown below.

Simplified description:
Select "30min."

Operation:
Rotate [DIAL] to select "30min."

Example: Set the "Auto Power OFF" item to "30 min."

Time Set > Auto Power OFF

1. Push [MENU].
2. Rotate [DIAL] to select "Time Set," then push [↵].



3. Select "Auto Power OFF," then push [↵].

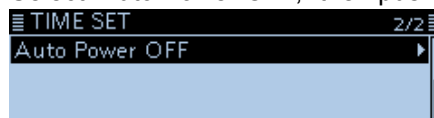

4. Select "30min," then push [↵].

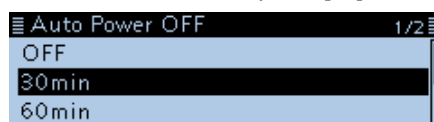

- Sets the option, then goes back a tree level. (TIME SET screen is displayed.)
5. Push [MENU].
 - Returns to the standby screen.

TIP: To return to the default setting:

1. Push [QUICK] in step 4.
2. Select "Default," then push [↵].

Menu items and Default settings

NOTE: The default settings shown in bold letters below are for the USA version. The default settings may differ, depending on your transceiver version.

DUP/TONE...	Settings to access repeaters.	
Offset Freq	0.000~ 0.600.00 *1~59.995 MHz	Sets the frequency offset for duplex (repeater) operation.
Repeater Tone	67.0~ 88.5 ~254.1 Hz	Selects a tone frequency used to access the repeaters.
TSQL Freq	67.0~ 88.5 ~254.1 Hz	Selects a tone frequency for the Tone Squelch or the Pocket Beep function.
Tone Burst	OFF or ON	Turns the Tone Burst function ON or OFF. This function is used to suppress the RX squelch tail noise in the FM mode, if you transmit a signal which superimposes the CTCSS tone or subaudible tone.
DTCS Code	023 ~754	Selects a DTCS (both encoder/decoder) code for DTCS Squelch or the Pocket Beep function.
DTCS Polarity	Both N , TN-RR, TR-RN, or Both R	Selects the DTCS polarity for the DTCS Squelch or the Pocket Beep function.
Digital Code	00 ~99	Selects a digital code for the Digital Code Squelch function.
Manage Memory	Manages your Memory or Call channel data.	
Memory CH	ALL, A~Z	Manages the Memory channels.
Call CH	C0/C1(144):146.010 FM*2 C0/C1(430):440.000 FM*2	Manages the Call channels.
Scan	Set scan options.	
Pause Timer	2sec~ 10sec ~20sec, or HOLD	Selects the Scan Pause time. When receiving signals, the scan pauses according to this set period of time.
Resume Timer	0sec~ 2sec ~5sec, or HOLD	Selects the Scan Resume time from a pause after the received signal disappears.
Temporary Skip Timer	5min , 10min, or 15min	Selects the Temporary Skip time. When the time is set, specified frequencies are skipped for this set period of time during a scan.
Program Skip	OFF or ON	Turns the Program Skip Scan function ON or OFF for a VFO mode scan.
Bank Link	A: <input checked="" type="checkbox"/> ~Z: <input checked="" type="checkbox"/>	Selects banks to be scanned during a Bank Link Scan.
Program Scan Edge	00~24	Sets the frequency ranges for a Program scan.
Program Link	See page 9-19 for details of the preset values.	Sets the Link function for the Program Scan Edge channels.

*1 The default value may differ, depending on the frequency band and the transceiver version.

*2 The default value may differ, depending on the transceiver version.

Menu items and Default settings (Continued)

NOTE: The default settings shown in bold letters below are for the USA version. The default settings may differ, depending on your transceiver version.

Voice Memo	Set the TX/RX voice recording options.	
QSO Recorder	Set QSO recorder options.	
<<REC Start>>*		Starts recording the received signal audio. ① While recording, <<REC Stop>> is displayed.
Play Files*		Plays the recorded audio.
Recorder Set		
REC Mode	TX&RX or RX Only	Selects whether or not to record the TX audio.
RX REC Condition	Always or Squelch Auto	Selects whether or not the squelch status affects the RX voice audio recording.
File Split	OFF or ON	Selects whether or not to automatically create a new file if transmission and reception, or squelch status (open and close) is changed.
PTT Auto REC	OFF or ON	Turns the PTT Automatic Recording function ON or OFF.
Player Set		
Skip Time	3sec, 5sec, 10sec , or 30sec	Sets the Skip time to rewind or forward the recorded audio when you push the fast-rewind or fast-forward key during playback.
DV Auto Reply*		Records a voice audio to use the Auto Reply function in the DV mode.
Voice TX	Set microphone voice recording options.	
Record*	T1~T4	Starts recording the microphone audio.
TX Set		
Repeat Time	1sec~ 5sec ~15sec	Sets the repeat interval. The transceiver repeatedly transmits the recorded voice audio at this interval.
TX Monitor	OFF or ON	The TX Monitor function outputs the TX voice audio from the speaker during voice transmission.
<<TX>>*	T1~T4, Repeat TX	The transceiver transmits the recorded voice audio.
GPS	Set GPS options.	
GPS Set		
GPS Select	OFF, Internal GPS , External GPS, or Manual	Selects either the internal or an external GPS receiver that the transceiver receives its position data from.
Manual Position		Manually enter your current position.
GPS Out (To DATA Jack)	OFF or ON	Turns the output of GPS information from the internal GPS receiver to the [DATA] jack ON or OFF.

* Be sure to insert the microSD card into the transceiver before selecting these items.

Menu items and Default settings (Continued)

NOTE: The default settings shown in bold letters below are for the USA version. The default settings may differ, depending on your transceiver version.

GPS TX Mode	Set the GPS TX mode.	
OFF		Turns OFF the GPS TX function.
D-PRS		
Unproto Address	API410,DSTAR*	Enters an unproto address, or keeps the default.
TX Format		
Position		
Symbol	1:Car , 2:Van, 3:Truck, or 4:House QTH (VHF)	Selects a D-PRS Symbol to transmit.
SSID	- - - , (-0), -1~-15, or -A~-Z	Selects the APRS® call sign SSID.
Comment		Enters a comment to transmit.
Time Stamp	OFF , DHM, or HMS	Selects the format to transmit the current UTC time as a time stamp.
Altitude	OFF or ON	Turns the altitude transmit option ON or OFF.
Data Extension	OFF , Course/Speed, or Power/Height/Gain/Directivity	Selects whether to transmit the course/speed data, or power/height/gain/directivity data.
Power	0W , 1W, 4W, 9W, 16W, 25W, 36W, 49W, 64W, or 81W	Selects a base station's TX power level to transmit.
Height	10ft , 20ft, 40ft, 80ft, 160ft, 320ft, 640ft, 1280ft, 2560ft, or 5120ft*	Selects a base station's height to transmit.
Gain	0dB ~9dB	Selects a base station's antenna gain to transmit.
Directivity	Omni , 45°NE, 90°E, 135°SE, 180°S, 225°SW, 270°W, 315°NW, or 360°N	Selects a base station's antenna directivity to transmit.
Object	Set Object data such as an earthquake information, satellite track information, and so on, to transmit along with the position data. An Object contains a time stamp.	
Object Name		Enters an Object's name to transmit.
Data Type	Live Object , Killed Object	Selects an Object's status to transmit.
Symbol	Radio	Selects an Object's symbol to transmit.
Comment		Enters an Object's comment to transmit.
Position		Sets an Object's position data to transmit.
Data Extension	OFF , Course/Speed, or Power/Height/Gain/Directivity	Selects whether to transmit an Object's course/speed data, or power/height/gain/directivity data.
Course	0° ~360°	Sets an Object's course to transmit.
Speed	0mph ~1150mph*	Sets an Object's speed to transmit.
Power	0W , 1W, 4W, 9W, 16W, 25W, 36W, 49W, 64W, or 81W	Selects an Object's TX power level information to transmit.
Height	10ft , 20ft, 40ft, 80ft, 160ft, 320ft, 640ft, 1280ft, 2560ft, or 5120ft*	Selects an Object's height information to transmit.
Gain	0dB ~9dB	Selects an Object's antenna gain information to transmit.

* The unit may differ, depending on the "Display Unit" settings. (p. 9-64)

Menu items and Default settings (Continued)

NOTE: The default settings shown in bold letters below are for the USA version. The default settings may differ, depending on your transceiver version.

Directivity	Omni , 45°NE, 90°E, 135°SE, 180°S, 225°SW, 270°W, 315°NW, or 360°N	Selects an Object's antenna directivity information to transmit.
SSID	- - - , (-0), -1~-15, or -A~-Z	Selects the APRS® call sign SSID for the Object.
Time Stamp	DHM or HMS	Selects a format to transmit the current UTC time as a time stamp.
Item	Set Item data such as a traffic accident, lighthouse, antenna, or DV access point location, and so on, to transmit along with the position data. An Item does not contain a time stamp.	
Item Name	Enters an Item's name to transmit.	
Data Type	Live Item , Killed Item	Selects an Item's status to transmit.
Symbol	Radio	Selects an Item's symbol to transmit.
Comment	Enters an Item's comment to transmit.	
Position	Sets an Item's position data to transmit.	
Data Extension	OFF , Course/Speed, or Power/Height/Gain/Directivity	Selects whether to transmit an Item's course/speed data, or power/height/gain/directivity data.
Course	0°~360°	Sets an Item's course to transmit.
Speed	0mph~1150mph*	Sets an Item's speed to transmit.
Power	0W , 1W, 4W, 9W, 16W, 25W, 36W, 49W, 64W, or 81W	Selects an Item's TX power level information to transmit.
Height	10ft , 20ft, 40ft, 80ft, 160ft, 320ft, 640ft, 1280ft, 2560ft, or 5120ft*	Selects an Item's height information to transmit.
Gain	0dB~9dB	Selects an Item's antenna gain information to transmit.
Directivity	Omni , 45°NE, 90°E, 135°SE, 180°S, 225°SW, 270°W, 315°NW, or 360°N	Selects an Item's antenna directivity information to transmit.
SSID	- - - , (-0), -1~-15, or -A~-Z	Selects the APRS® call sign SSID for the Item.
Weather		
Symbol	WX Station	Selects a weather station's symbol to transmit.
SSID	- - - , (-0), -1~-15, or -A~-Z	Selects the APRS® call sign SSID for the weather station.
Comment	Enters a weather station's comment to transmit.	
Time Stamp	OFF, DHM , or HMS	Selects a format to transmit the current UTC time as a time stamp.
NMEA		
GPS Sentence	RMC, GGA , GLL, VTG, GSA, or GSV	Transmits position data in selected GPS sentences.
GPS Message	Enter a GPS message to be transmitted.	
GPS Information	Displays the received GPS information.	
GPS Position	Displays your position, RX station, GPS memory, and Alarm positions.	
GPS Memory	(No Group), A~Z	Displays the GPS memory contents.

* The unit may differ, depending on the "Display Unit" settings. (p. 9-64)

Menu items and Default settings (Continued)

NOTE: The default settings shown in bold letters below are for the USA version. The default settings may differ, depending on your transceiver version.

GPS Alarm		
Alarm Select	OFF , RX, Group, or Memory	Select the target for the GPS alarm function.
Alarm Area (Group)	0.08' ~ 0.25' ~ 59.99' ^{*1}	Enter the GPS alarm active range.
Alarm Area (RX/Memory)	Limited, Extended, or Both	Select the GPS alarm active range.
GPS Logger ^{*2}		
GPS Logger	OFF or ON	Turns the GPS Logger function ON or OFF, to save your route as you move.
Record Interval	1sec, 5sec , 10sec, 30sec, or 60sec	Selects the GPS Logger function record interval.
Record Sentence	<input checked="" type="checkbox"/> RMC/ <input checked="" type="checkbox"/> GGA/ <input checked="" type="checkbox"/> VTG/ <input checked="" type="checkbox"/> GSA	Selects the GPS Logger function record sentences.
GPS Auto TX	OFF , 5sec, 10sec, 30sec, 1min, 3min, 5min, 10min, or 30min	Selects a time option for the GPS automatic transmission function.

Call Sign		
Set and display the DV mode call signs.		
UR: CQCQCQ, R1: -----, R2: -----, MY: -----		Displays the operating call signs. Sets the operating call signs according to the type of call you want to make.

RX History		
Displays the received call history in the DV mode.		
RX01:		Displays the calls your transceiver received.

DV Memory		
Saves call signs or repeater information to use in the DV mode.		
Your Call Sign	Blank	Saves station call signs. Add or edit call signs.
Repeater List	01:~50:	Saves repeater information. Add or edit a repeater information.

NOTE: The repeater list described in this manual may differ from your preloaded list.

My Station		
Sets and saves MY call sign to use in the DV mode.		
My Call Sign	1:~6:	Saves MY call signs. Select or edit a MY call sign to use in the DV mode.
TX Message	1:~5: or OFF	Saves TX Messages. Select or edit TX Message to use in the DV mode.

DV Set		
Sets values for the DV mode operations.		
Tone Control		
RX Bass	Cut, Normal , or Boost	Sets the DV mode received audio bass filter level to Cut, Normal or Boost.
RX Treble	Cut, Normal , or Boost	Sets the DV mode received audio treble filter level to Cut, Normal or Boost.
RX Bass Boost	OFF or ON	Turns the DV mode received audio Bass Boost function ON or OFF

^{*1} The unit may differ, depending on the "Display Unit" settings. (p. 9-64)

^{*2} Be sure to insert the microSD card into the transceiver before selecting these items.

Menu items and Default settings (Continued)

NOTE: The default settings shown in bold letters below are for the USA version. The default settings may differ, depending on your transceiver version.

TX Bass	Cut, Normal , or Boost	Sets the DV mode transmit audio bass filter level to Cut, Normal or Boost.
TX Treble	Cut, Normal , or Boost	Sets the DV mode transmit audio treble filter level to Cut, Normal or Boost.
Auto Reply	OFF , ON, Voice, or Position	Selects the Automatic Reply function.
DV Data TX	PTT or Auto	Selects to manually or automatically transmit low speed data.
DV Fast Data		The DV Fast data mode sends data through both the audio and data frames in the DV mode. The data speed of the DV Fast data mode (approximately 3480 bps) is 3.5 times faster than the lowspeed data communication mode (approximately 950 bps). In the DV Fast data mode, no audio can be sent.
Fast Data	OFF or ON	Selects whether or not to use DV Fast data mode for data communication in the DV mode.
GPS Data Speed	Slow or Fast	Set the GPS data transmission speed in the DV Fast data mode.
TX Delay (PTT)	1sec~ 2sec ~10sec, or OFF	Set the TX delay time after releasing [PTT] when the "DV Data TX" item is set to "PTT" and data is sent using the DV Fast data function.
Digital Monitor	Auto , Digital, or Analog	Selects the DV mode RX monitoring when [SQL] is held down.
Digital Repeater Set	OFF or ON	Turns the digital repeater setting function ON or OFF. This function is usable in any DV mode except when using the DR function.
DV Auto Detect	OFF or ON	Turns the DV mode automatic detect function ON or OFF.
RX Record (RPT)	ALL or Latest Only	The transceiver can record the data of up to 50 individual calls.
BK	OFF or ON	Turns the Break-in (BK) function ON or OFF. The BK function enables you to break into a conversation between two stations with call sign squelch enabled.
EMR	OFF or ON	Turns the Enhanced Monitor Request (EMR) communication mode ON or OFF. After turning OFF the transceiver, the EMR mode will be canceled.
EMR AF Level	0~ 19 ~32	Sets the audio output level when an EMR mode signal is received.

Menu items and Default settings (Continued)

NOTE: The default settings shown in bold letters below are for the USA version. The default settings may differ, depending on your transceiver version.

SPEECH Sets the Speech functions.		
RX Call Sign SPEECH	OFF, ON (Kerchunk) , or ON (All)	Selects the RX call sign speech function option while ON, or turns it OFF.
RX>CS SPEECH	OFF or ON	Turns the RX>CS Speech function ON or OFF.
DIAL SPEECH	OFF or ON	Turn the Dial Speech function ON or OFF.
MODE SPEECH	OFF or ON	Turn the Operating Mode Speech function ON or OFF.
SPEECH Language	English or Japanese	Selects either English or Japanese as the speech language.
Alphabet	Normal or Phonetic Code	Selects the alphabet character announcement type.
SPEECH Speed	Slow or Fast	Selects Slow or Fast speech speed
SPEECH Level	0~7~9	Sets the volume level for the voice synthesizer.
DTMF Sets the DTMF Memory functions.		
DTMF Memory	d0:~d9: , dA:~dD: , d*: , or d#:	Displays a list of the DTMF memory channels. The DTMF memory can save up to 24-digit DTMF code.
DTMF Speed	100ms , 200ms, 300ms, or 500ms	Selects the DTMF transmit speed.
QSO/RX Log Sets the QSO/RX History Log options.		
QSO Log*1	OFF or ON	Selects whether or not to make a communication log on the microSD card.
RX History Log*1	OFF or ON	Selects whether or not to make a DV mode's receive history log on the microSD card.
CSV Format		
Separator/Decimal	Sep [,] Dec [.] *3, Sep [;] Dec [.] , or Sep [;] Dec [,]	Selects the separator and the decimal character for the CSV format.
Date	yyyy/mm/dd, mm/dd/yyyy *3, or dd/mm/yyyy	Selects the date format.
Function Sets various function's options.		
Squelch/ATT Select	OFF, S-Meter Squelch , or ATT	Selects to use the S-Meter Squelch or the Attenuator function for the [SQL] control.
Squelch Delay	Short or Long	Selects to shorten or lengthen the time until the squelch opens.
Fan Control	Slow, Mid, Fast, or Auto	Selects the cooling fan control action.
Dial Speed-UP	OFF or ON	Turns the dial speed acceleration ON or OFF.
Auto Repeater*2	OFF, ON (DUP) , or ON (DUP,TONE)	Turns the Auto Repeater function ON or OFF.

*1 Be sure to insert the microSD card into the transceiver before selecting these items.

*2 Displayed only in the USA version transceivers.

*3 The default value may differ, depending on the transceiver version.

Menu items and Default settings (Continued)

NOTE: The default settings shown in bold letters below are for the USA version. The default settings may differ, depending on your transceiver version.

Remote MIC Key		Selects the key function for [F-1] or [F-2] on the supplied remote-control microphone.
During RX/Standby	[F-1]:MODE [F-2]:Monitor	Selects the key function to be used while receiving or in the standby mode.
During TX	[F-1]:T-CALL [F-2]:---	Selects the key function to be used while transmitting.
Up/Down MIC Key		Selects the key function for [UP] or [DN] on the optional hand microphone.
During RX/Standby	[UP]:UP [DN]:DOWN	Selects the key function to be used while receiving or in the standby mode.
During TX	[UP]:--- [DN]:---	Selects the key function to be used while transmitting.
One-Touch PTT(Remote MIC)	OFF or ON	Turns the One-Touch PTT function ON or OFF.
PTT Lock	OFF or ON	Turns the PTT Lock function ON or OFF.
Busy Lockout	OFF or ON	Turns the Busy Lockout function ON or OFF.
Time-Out Timer	OFF , 1min, 3min, 5min, 10min, 15min, or 30min	Selects the Time-Out Timer time options.
Active Band	Single or All	Enables continuous frequency selection across all bands by rotating [DIAL].
MIC Gain	1~ 2 *~4	Sets the microphone sensitivity to suit your preference.
Data Speed	4800bps or 9600bps	Selects the data transmission speed for low-speed communication, or between the [DATA] jack and external modules like a GPS receiver, and so on.
CI-V		
CI-V Address	02h~ 9Ah ~DFh	Sets the transceiver's unique CI-V hexadecimal address code.
CI-V Baud Rate	4800, 9600, 19200, or Auto	Sets the CI-V code transfer speed.
CI-V Transceive	OFF or ON	Turns the CI-V Transceive function ON or OFF.
CI-V Bluetooth→REMOTE transceive Address	00 ~DFh	Sets the address to inhibit the external control with CI-V for the transceiver through the [SP] (REMOTE) jack.
Power OFF (With No Controller)	OFF or ON	Selects whether or not to automatically turn OFF the transceiver when the controller is disconnected from the transceiver.
Display	Sets the Display options.	
LCD Backlight Brightness	1~ 4	Selects the LCD backlight brightness level.
LCD Backlight Color	White , Amber, Green, or Blue	Selects the LCD backlight color.
Key Backlight Brightness	1~ 4	Selects the key backlight brightness level.
Key Backlight Color	White , Amber, Green, or Blue	Selects the key backlight color.

* The default value may differ, depending on the transceiver version.

Menu items and Default settings (Continued)

NOTE: The default settings shown in bold letters below are for the USA version. The default settings may differ, depending on your transceiver version.

Backlight Night Time Setting

Night Time Setting	OFF or ON	Selects whether or not to turn down the backlight brightness for nighttime operation.
Brightness	1~ 2 ~4	Selects the backlight brightness level for nighttime operation.
Night Time Start	0:00~ 18:00 ~23:59	Sets the start time for nighttime operation.
Night Time End	0:00~ 6:00 ~23:59	Sets the end time for nighttime operation.

Auto Dimmer Setting

Auto Dimmer	OFF , Auto-OFF, or Auto 1~3	Sets the Auto Dimmer function for nighttime operation.
Auto Dimmer Timer	5sec , 10sec	Sets the period of time until the backlight turns OFF when "Auto Dimmer" is set to "Auto-OFF" or "Auto-1" to "Auto-3."
Auto Dimmer Cancel (PTT)	OFF or ON	Select the transceiver operation when [PTT] is pushed when the Auto Dimmer is activated.
Auto Dimmer Cancel (DV RX)	OFF or ON	Select the transceiver operation when receiving a DV signal while the Auto Dimmer is activated.
LCD Contrast	1~ 8 ~16	Sets the contrast level of the LCD.
RX Call Sign	OFF, Normal , RX Hold, or Hold	Selects the call sign and message display option when receiving a call.
RX Position Indicator	OFF or ON	Selects whether or not to display the indicator when the position data is included in the signal received in the DV mode.
RX Position Display	OFF or ON	Selects whether or not to display the caller's position data in a dialog when the data is included in the signal received in the DV mode.
RX Position Display Timer	5sec, 10sec , 15sec, 30sec, or Hold	Sets the RX position data display period of time.
Reply Position Display	OFF or ON	Selects whether or not to display the caller's position data in a dialog when the data is included in the Auto Reply signal.
TX Call Sign	OFF, Your Call Sign , or My Call Sign	Selects whether or not to display My or Your call sign while transmitting.
Scroll Speed	Slow or Fast	Selects the scrolling speed of the message, call sign, or other text.
Opening Message	OFF or ON	Selects whether or not to display the opening message at power ON.
Voltage (Power ON)	OFF or ON	Selects whether or not to display the power source voltage at power ON.

* The default value may differ, depending on the transceiver version.

Menu items and Default settings (Continued)

NOTE: The default settings shown in bold letters below are for the USA version. The default settings may differ, depending on your transceiver version.

Display Unit		
Latitude/Longitude	ddd°mm.mm' or ddd°mm'ss"	Selects position format to display the position.
Altitude/Distance	m or ft/ml *	Selects the units to display the distance and altitude.
Speed	km/h, mph *, or knots	Selects the units to display the speed.
Temperature	°C or °F *	Selects the units to display the temperature.
Barometric	hPa, mb, mmHg, or inHg *	Selects the units to display the barometric pressure.
Rainfall	mm or inch *	Selects the units to display the rainfall.
Wind Speed	m/s, mph *, or knots	Selects the units to display the wind speed.
Display Language	English or Japanese	Selects the display language in the DR screen or MENU screen. When "English" is selected in "System Language," this item is not displayed.
System Language	English or Japanese	Selects English or Japanese as the system language of the transceiver.
Sounds Sets the Sound options.		
Beep Level	0~9	Sets the beep output level.
Key-Touch Beep	OFF or ON	Turns the confirmation beep tones ON or OFF when key is pushed.
Home CH Beep	OFF or ON	Turns the Home CH Beep ON or OFF.
Band Edge Beep	OFF or ON	Turns the Band Edge Beep ON or OFF.
Scan Stop Beep	OFF or ON	Turns the Scan Stop Beep ON or OFF.
Standby Beep	OFF, ON, ON (to me:High Tone), or ON (to me:Alarm/High Tone)	Turns the Standby Beep function in the DV mode ON or OFF.
Scope AF Output	OFF or ON	Selects the audio output option during a sweep.
Time Set Sets the Time options.		
Date/Time		
DATE	2000/01/01~2099/12/31	Sets the current date.
TIME	0:00~23:59	Sets the current time.
GPS Time Correct	OFF or Auto	Sets to automatically correct the time using a GPS signal.
UTC Offset	-14:00~ ±0:00 ~+14:00	Enters the time difference between UTC and the local time.
Auto Power OFF	OFF , 30min, 60min, 90min, or 120min	Turns the Auto power OFF function ON or OFF.
DV Gateway Enters the Terminal mode or Access Point mode.		
<<Terminal Mode>>		Enters the Terminal mode.
<<Access Point Mode>>		Enters the Access Point mode.

* The default value may differ, depending on the transceiver version.

Menu items and Default settings (Continued)

NOTE: The default settings shown in bold letters below are for the USA version. The default settings may differ, depending on your transceiver version.

SD Card*1		Sets the microSD card options.
Load Setting		
File selection	ALL, Except My Station, or Repeater List Only	Loads the settings file to the transceiver.
Save Setting		
<<New File>>		Saves the settings as a new file.
File selection		Saves the settings in a selected file.
Import/Export		
Import	Your Call Sign, Repeater List, or GPS Memory	Imports the Your call sign, Repeater list, or GPS memory data in the CSV format file.
Export	Your Call Sign, Repeater List, or GPS Memory	Exports the Your call sign, Repeater list, or GPS memory data in the CSV format file.
CSV Format		
Separator/Decimal	Sep [.,] Dec [.] *2, Sep [;] Dec [.,] or Sep [;] Dec [.]	Selects the separator and the decimal character for the CSV format.
Date	yyyy/mm/dd, mm/dd/yyyy *2, or dd/mm/yyyy	Selects the date format.
SD Card Info		Displays the free space and remaining recording time of the card.
Firmware Update		Enters the Firmware Update mode.
Format		Formats the card.
Unmount		Electronically unmounts the card.
Bluetooth Set*3		Sets the Bluetooth options.
Bluetooth	OFF or ON	Turns the Bluetooth function ON or OFF.
Auto Connect	OFF or ON	Selects whether or not to automatically connect to a paired Bluetooth device when the device is turned ON.
Pairing/Connect		Pairs or connects to a Bluetooth device.
Device Search		
Search Headset		Searches for Bluetooth headsets.
Search Data Device		Searches for Bluetooth data devices.
Pairing list		Displays paired devices.
<<Pairing Reception>>		Accepts the connection request from a Bluetooth device.

*1 Be sure to insert the microSD card into the transceiver before selecting these items.

*2 The default value may differ, depending on the transceiver version.

*3 The optional UT-137 Bluetooth unit is required.

Menu items and Default settings (Continued)

NOTE: The default settings shown in bold letters below are for the USA version. The default settings may differ, depending on your transceiver version.

Headset Set		
AF Output	Headset Only or Headset & Speaker	Selects the AF output option when you use a Bluetooth headset.
Headset Function Select	Normal , Microphone, or PTT	Select the PTT and microphone combination when either a Bluetooth headset or the radio microphone are used.
VOX		
VOX	OFF or ON	Turn the VOX function ON or OFF when you use a Bluetooth headset.
VOX Level	OFF, 1~ 5 ~10	Set the MIC Gain level. If the microphone input level is higher than this set value, the transceiver starts to transmit, and if the input level is lower than this set value, returns to receive.
VOX Delay	0.5sec , 1.0sec, 1.5sec, 2.0sec, 2.5sec, or 3.0sec	Sets the VOX Delay time for the transmitter stays ON after you stop speaking before the VOX switches to receive.
VOX Time-Out Timer	OFF, 1min, 2min, 3min , 4min, 5min, 10min, or 15min	Sets the VOX Time-Out Timer to prevent an accidental prolonged transmission.
Icom Headset		Sets to use the optional Icom VS-3 Bluetooth headset.
Power Save	OFF or ON	Sets the Power save function to prolong the headset battery life.
One-Touch PTT	OFF or ON	Sets the One-Touch PTT function to change between transmission and reception by pushing [PTT].
PTT Beep	OFF or ON	Sets to sound a beep when you push [PTT].
Custom Key Beep	OFF or ON	Sets to sound a beep when you push custom key ([PLAY]/[FWD]/[RWD]).
Custom Key	[PLAY]:---, [FWD]:UP, [RWD]: DOWN	Selects the key function of custom key ([PLAY]/[FWD]/[RWD]).
Data Device Set		Sets the data device options.
Serialport Function	CI-V (Echo Back OFF) , CI-V(Echo Back ON), or DV Data	Selects to transmit or receive CI-V commands or DV data.
Bluetooth Device Information		Displays the optional UT-137 Bluetooth UNIT information.
Initialize Bluetooth Device		Resets the optional UT-137 Bluetooth UNIT.

Menu items and Default settings (Continued)

NOTE: The default settings shown in bold letters below are for the USA version. The default settings may differ, depending on your transceiver version.

Others		Set other options.
Information		
Voltage		Displays the power source voltage.
Version		Displays the transceiver's firmware version number.
Clone		
Clone Mode		Reads or writes the CS-4100 data from or to the PC.
Reset		
Partial Reset		Returns all settings to their defaults, without clearing the memory contents, call sign memories or repeater lists.
All Reset		Clears all entries and memories, and returns all settings to their defaults.

DUP/TONE items

Offset frequency (Default: 0.600.00*)

DUP/TONE... > Offset Freq

Set the frequency offset for duplex (repeater) operation to between 0.000.00 and 59.99500 MHz.

- ① The duplex shift direction (DUP-/DUP+) is set in the duplex setting window.
- ① When the DR function is ON, editing is restricted.

*The default value may differ, depending on the frequency band and the transceiver version.

Repeater Tone (Default: 88.5)

DUP/TONE... > Repeater Tone

Select a CTCSS tone frequency for repeater access and other functions.
50 tone frequencies (67.0 ~ 254.1 Hz) are selectable.

TSQL Freq (Default: 88.5)

DUP/TONE... > TSQL Freq

Select a CTCSS tone frequency for the tone squelch or the Pocket beep function.
50 frequencies (67.0 ~ 254.1 Hz) are selectable.

• Selectable repeater tone/tone squelch frequencies (Unit: Hz)

67.0	85.4	107.2	136.5	165.5	186.2	210.7	254.1
69.3	88.5	110.9	141.3	167.9	189.9	218.1	
71.9	91.5	114.8	146.2	171.3	192.8	225.7	
74.4	94.8	118.8	151.4	173.8	196.6	229.1	
77.0	97.4	123.0	156.7	177.3	199.5	233.6	
79.7	100.0	127.3	159.8	179.9	203.5	241.8	
82.5	103.5	131.8	162.2	183.5	206.5	250.3	

Tone Burst (Default: OFF)

DUP/TONE... > Tone Burst

Turn the Tone Burst function ON or OFF in the FM mode when using tone squelch.

- OFF: When you transmit a signal that superimposes the CTCSS tone, the other station may hear a short burst of noise from their receiver, just after you stop transmitting.
- ON: When you transmit a signal that superimposes the CTCSS tone, the function mutes the noise from being heard in the other station's receiver.

DTCS Code (Default: 023)

DUP/TONE... > DTCS Code

Select a DTCS (both encoder/decoder) code for the DTCS squelch.

A total of 104 codes (023 ~ 754) are selectable.

• Selectable DTCS codes

023	072	152	244	311	412	466	631
025	073	155	245	315	413	503	632
026	074	156	246	325	423	506	654
031	114	162	251	331	431	516	662
032	115	165	252	332	432	523	664
036	116	172	255	343	445	526	703
043	122	174	261	346	446	532	712
047	125	205	263	351	452	546	723
051	131	212	265	356	454	565	731
053	132	223	266	364	455	606	732
054	134	225	271	365	462	612	734
065	143	226	274	371	464	624	743
071	145	243	306	411	465	627	754

DTCS Polarity (Default: Both N)

DUP/TONE... > DTCS Polarity

Select the DTCS polarity to use for transmitting and receiving.

- Both N: Normal polarity is used for both TX and RX.
- TN-RR: Normal polarity is used for TX; Reverse polarity for RX.
- TR-RN: Reverse polarity is used for TX; Normal polarity for RX.
- Both R: Reverse polarity is used for both TX and RX.

DTCS code's polarity for transmitting or receiving can be independently set with this item.

Digital Code (Default: 00)

DUP/TONE... > Digital Code

Select the digital code for digital code squelch.

A total of 100 codes (00 ~ 99) are selectable.

Manage Memory items

Memory CH

Manage Memory > Memory CH

You can delete, copy and edit your memory data.
Up to 1000 Memory channels can be saved.
Also, 26 memory banks, A to Z, can be used to save groups of operating channels, and so on.

Up to 100 channels can be assigned to a bank.

- ALL: All Memory channels are listed.
- A–Z: Memory channels that is saved in the bank are listed.

Call CH

Manage Memory > Call CH

You can delete, copy or edit your Call channel data.
The Call channel can be assigned to 2 different channels (C0 and C1) in the 144 MHz and 430 MHz bands.

The default setting is differ, depending on the transceiver version.

Scan items

Pause Timer (Default: 10sec)

Scan > Pause Timer

Select the scan Pause time. When receiving a signal, the scan pauses for the scan Pause Timer time.

- 2sec ~ 20sec : When a signal is received, the scan pauses for 2 ~ 20 seconds (set in 2 second steps).
- HOLD : The scan pauses on a received signal until the signal disappears.

Resume Timer (Default: 2sec)

Scan > Resume Timer

Select the scan Resume Timer time.

When a received signal disappears, the scan resumes according to the scan Resume Timer setting.

- 0sec: The scan resumes immediately after the signal disappears.
- 1sec ~ 5sec: The scan resumes 1 ~ 5 seconds after the signal disappears.
- HOLD: The scan remains paused for the Pause Timer setting, even if the signal disappears.

NOTE: Rotate [DIAL] to resume the scan. The Resume Timer must be set shorter than the Pause Timer, otherwise this timer does not work properly.

Temporary Skip Timer (Default: 5min)

Scan > Temporary Skip Timer

Set the Temporary Skip Timer to 5, 10 or 15 minutes. When the time is set, the unwanted frequencies are skipped for this set period during a scan.

This timer is activated for the VFO scan, Memory scan and DR scan.

Program Skip (Default: ON)

Scan > Program Skip

Turn the Program Skip Scan function ON or OFF for a VFO mode scan.

This function enables the transceiver to skip the unwanted frequencies or channels that inconveniently stop scanning.

Set the unwanted frequencies or channels to "PSKIP" in the Memory Channel screen.

- OFF: The transceiver scans all frequencies.
- ON: The transceiver does not scan frequencies set as "PSKIP" frequencies.

Bank Link (Default: A: ~ Z:)

Scan > Bank Link

Select banks to be scanned during a Bank Link Scan. The Bank Link function scans all channels in the selected banks.

Select a bank, A ~ Z, then push [↵] to turn the Link function ON or OFF.

- Displays "✓" when the function is set to ON.

Program Scan Edge

Scan > Program Scan Edge

You can delete, copy or edit the lower and higher frequencies for programmed scans.

The transceiver has a total of up to 25 frequency ranges (00 ~ 24), and you can set scan name, tuning step, and the receive mode for each scan edge. The default setting is differ, depending on the transceiver version.

See page 2-9 for Entering scan edges.

Scan items (Continued)

Program Link (Default: Refer to the table below)

Scan > Program Link

This item sets the link function for two or more program scan edge ranges to be sequentially scanned during the Program Link Scan. The link function scans all frequencies in the scan range.

Default settings of the Program Link

The Program Scan Edge channels "01" and "02" are set in the Program Link No. 0 as the default.

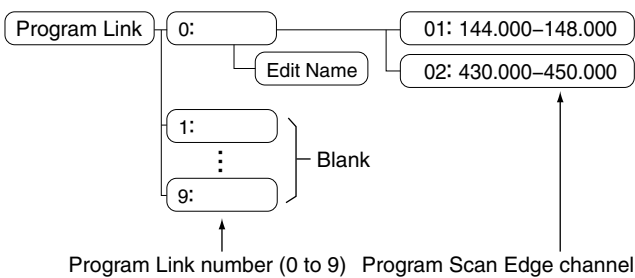

- ① The Program Link No. screen displays the frequency range. (The default scan edge frequency may differ, depending on the transceiver version.)
- ① You can add a link setting by pushing [QUICK] when two or more pairs of Program Scan Edge channels are entered.
- ① When only one Program Scan Edge channel is entered, or there is no Programmed Scan Edge (00 to 24) is left, "Add" is not displayed after pushing [QUICK].

Adding a Scan Edge channel to the Program Link

1. Select a Program Link number between 0 and 9, then push [↵].
2. Push [QUICK].
3. Select "Add," then push [↵].



4. Select a programmed scan number you want to add to the selected link channel.

(Example: 00: 118.000-550.000)

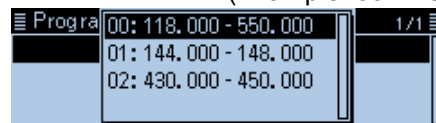

5. Push [MENU].
 - Returns to the standby screen.

Deleting the link channel

1. Select a Program Link number between 0 and 9, then push [↵].
2. Select the programmed scan number you want to delete. (Example: 02: 430.000-450.000)

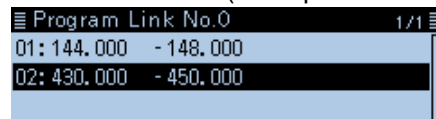

3. Push [QUICK].
4. Select "Delete," then push [↵].

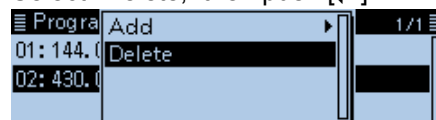

5. Push [MENU].
 - Returns to the standby screen.

Scan items (Continued)

Editing a Program Scan Link name

1. Select a Program Link number between 0 and 9, then push [QUICK].



2. Select "Edit Name," then push [↵].

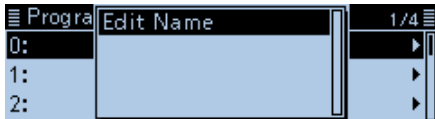

- Enters the Program Link Name edit mode.

3. Enter a Program Scan Link name of up to 16 characters.

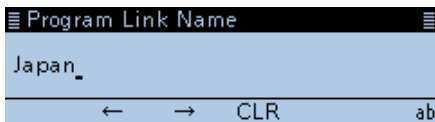

(Example: Japan)

Selectable characters and symbols

A to Z, a to z, 0 to 9, ! " # \$ % & ' () * +
 , - . / : ; < = > ? @ [\] ^ _ ` { | } ~ (space)

① See "Entering and editing text" for details. (p. iv)

4. After entering, push [↵].

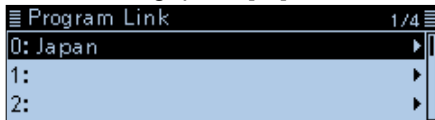

5. Push [MENU].
 - Returns to the standby screen.

Voice Memo items (For Record/Playback)

<<REC Start>>

Voice Memo > QSO Recorder > <<REC Start>>

After selecting “<<REC Start>>,” push [↵] to start voice recording.

- “Recording started.” is displayed.

① Information

- Be sure a microSD card is in the card slot.
- While recording, “<<REC Stop>>” is displayed on the QSO RECORDER screen. To stop recording, select “<<REC Stop>>.”
- Once recording has started, the recording will continue, even if the transceiver is turned OFF and then later turned ON again.

Play Files

Voice Memo > QSO Recorder > Play Files

Performs the following steps to play back the recorded audio on the microSD card.

TIP: Be sure a microSD card is in the card slot.

Playing back

1. Select “Play Files,” then push [↵].
 - Displays the folders on the microSD card
 - ① These folders contain the recorded audio files.
2. Select the folder that includes the audio file to play back, then push [↵].
3. Select the file to play back, then push [↵].
 - The VOICE PLAYER screen is displayed and the selected file is played back.
 - ① See “The VOICE PLAYER screen description” for forwarding or rewinding. (p. 7-3)
4. Push [MENU].
 - Returns to the standby screen.

NOTE:

- The folder name is automatically created, as shown below:
Recording date: 1st April 2017
Folder name: 20170401
- The file name is automatically created, as shown below:
Recording date and time: 1st April 2017 15:30:00
File name: 20170401_153000
- The voice audio is recorded onto a microSD card, and saved in the “wav” format. (“.wav” is not displayed on the transceiver’s screen.)
- The recorded voice audio can also be played back with a PC.

REC Mode

(Default: TX&RX)

Voice Memo > QSO Recorder > Recorder Set > REC Mode

Records both the transmitted and received audio as the default setting.

- TX&RX: Records both the transmitted and received voice audio.
- RX Only: Records only the received voice audio.

When transmitted while recording

When “File Split” is set to “OFF,” the recording is paused. After you finish transmitting, the recording resumes.

When “File Split” is set to “ON,” a new file is automatically created, and the transmitted voice audio is recorded into the new one.

RX REC Condition

(Default: Squelch Auto)

Voice Memo > QSO Recorder > Recorder Set > RX REC Condition

Select whether or not the squelch status affects the RX voice audio recording.

- Always: The transceiver always records the RX voice audio regardless of the squelch status.
- Squelch Auto: The transceiver records the RX voice audio only when a signal is received (the squelch is opened). When the squelch closes while recording, the recording will continue for 2 seconds, and then pause.

File Split

(Default: ON)

Voice Memo > QSO Recorder > Recorder Set > File Split

Turn the File Split function ON or OFF.

- OFF: When the recording starts, a new file is automatically created in the folder on the microSD card. The voice audio is continuously recorded into the file, even if transmission and reception, or the squelch status (open and close) is switched.
If the file size exceeds 2 GB, a new file is automatically created in the same folder, and the voice audio is recorded there.
- ON: When the recording starts, a new file is automatically created in the folder of the microSD card. During recording, and if transmission and reception, or squelch status (open and close) is switched, a new file is automatically created in the same folder, and the voice audio is saved into the new one.

Voice Memo items (Continued)

PTT Auto REC (Default: OFF)

Voice Memo > QSO Recorder > Recorder Set > **PTT Auto REC**

Turn the PTT Automatic Recording function ON or OFF.

- ① Transmitting from a Bluetooth VOX device, or sending a CI-V command also starts recording.
- ① When "REC Mode" is set to "RX Only," the transmitted voice audio is not recorded.

- OFF: Turns OFF the function.
- ON: The recording automatically starts when [PTT] is pushed.

The recording will stop when:

- No signal is transmitted for 10 seconds after releasing [PTT].
- No signal is received for 10 seconds after releasing [PTT].
 - When transceiver receives a signal 10 seconds after releasing [PTT], the recording automatically starts.
- Frequency or operating mode is changed after releasing [PTT].

Skip Time (Default: 10sec)

Voice Memo > QSO Recorder > Player Set > **Skip Time**

Select the Skip timer to 3, 5, 10 or 30 seconds to rewind or skip forward for this set period when you push the fast-rewind or fast-forward key while playing the recorded voice audio.

- ① See "The VOICE PLAYER screen description" for forwarding or rewinding. (p. 7-3)

DV Auto Reply

Voice Memo > **DV Auto Reply**

Up to 10 seconds of audio can be recorded for the automatic reply function.

TIP: Be sure a microSD card is in the card slot.

- ① See "Automatic Reply function" for details. (p. 4-24)

Voice TX items

Record

Voice TX > Record

Up to one minute of audio can be recorded onto a microSD card for voice transmission. (p. 10-5)
 Four independent voice audios can be memorized into each memory T1 ~ T4.
 While recording a QSO voice audio, this function is disabled.

TIP: Be sure a microSD card is in the card slot.

Repeat Time (Default: 5sec)

Voice TX > TX Set > Repeat Time

Set the repeat period of time to between 1 and 15 seconds (in 1 second steps).
 The transceiver repeatedly transmits the recorded voice audio for this set period of time.

NOTE: The recorded voice audio is repeatedly transmitted for up to 10 minutes. If 10 minutes passes while transmitting, the transceiver continues to transmit until the complete voice audio transmission is finished.

TX Monitor (Default: ON)

Voice TX > TX Set > TX Monitor

Turn the TX Monitor function ON or OFF.

- OFF: The TX voice audio is not heard from the speaker.
- ON: The TX voice audio is heard from the speaker.

<<TX>>

Voice TX > <<TX>>

The transceiver transmits the recorded voice audio. If the memory T1 ~ T4 with "Repeat TX" is selected, the recorded voice audio is repeatedly transmitted for up to 10 minutes, at the "Repeat Time" interval. (p. 10-6)

NOTE:

- If 10 minutes passes while transmitting, the transceiver continues to transmit until the complete voice audio transmission is finished.
- Any one of the following action will cancel the transmission.
 - Push [PTT].
 - Turn OFF the transceiver, then turn it ON again.
 - Push any key (except for [VOL] and [⏻]).

GPS items

GPS Select (Default: Internal GPS)

GPS > GPS Set > GPS Select

Select either the internal or external GPS receiver that the transceiver receives its position data from, or to manually enter your current position data.

- OFF: A GPS receiver is not used.
- Internal GPS: Position data of the internal GPS data is used for the GPS functions.
- External GPS: Position data of an external GPS receiver is used for the GPS functions.
- Manual: Manually enter the current Latitude, Longitude and Altitude in Manual Position.

- ① Data communication is disabled when “External GPS” is selected. (p. 4-27)
- ① When “External GPS” is set, but if the external GPS receiver is not connected, the internal GPS receiver is temporarily turned ON if you use the Automatic Position Reply function.

Manual Position (Default: LATITUDE : 0°00.00'N, LONGITUDE : 0°00.00'E ALTITUDE : -----ft)

GPS > GPS Set > Manual Position

Manually enter the latitude, longitude and Altitude of your current position.

- ① You can capture the position from the GPS receiver if “Capture From GPS” is selected. (p. 5-18)

GPS Out (To DATA jack) (Default: OFF)

GPS > GPS Set > GPS Out (To DATA Jack)

Select whether or not the position data of the internal GPS receiver is output to the [DATA] jack.

TIP:

- When “GPS Select” is set to “OFF,” “External GPS,” or “Manual,” GPS position data is not output from the [DATA] jack.
- When you want to operate data communication in the DV mode, set to “OFF.”

GPS TX Mode (Default: OFF)

GPS > GPS TX Mode

Select a GPS transmission mode to send a GPS position data while in the DV mode.

- OFF: Does not transmit a GPS data.
- D-PRS: Transmits GPS data in the D-PRS format.
- NMEA: Transmits a GPS data in the NMEA format.

Unproto Address (Default: API410,DSTAR*)

GPS > GPS TX Mode > D-PRS > Unproto Address

Displays an unproto address of up to 56 alphanumeric characters.

NOTE: You should use the default address, and editing is not recommended.

TX Format (Default: Position)

GPS > GPS TX Mode > D-PRS > TX Format

Select the format to transmit the position data in the D-PRS mode.

- Position: The caller station is the mobile or base station.
- Object: Transmits a certain location's information, such as an event, earthquake, and so on. (time stamp data is included.)
- Item: Transmits repeater or antenna information that needs no time information. (time stamp data is not included.)
- Weather: Transmits weather information received from a weather device.

Symbol (Default: Car)

GPS > GPS TX Mode > D-PRS > TX Format > Position > Symbol

Select the symbol that indicates your operating situation. The selected symbol channel's symbols (1~4) are transmitted along with the position data.

Editing a symbol

1. Select the symbol channel, then push [QUICK].
2. Select “Edit Symbol,” then push [↵].
3. Push [QUICK].
4. Select “Direct Input,” then push [↵].
5. Push [MW] to move the cursor to the second digit, or push [MODE] to move the cursor to the first digit.
6. Rotate [DIAL] to select a character or symbol to the selected digit.

Selectable characters and symbols

<For the first digit> /, \, 0 to 9, A to Z

<For the second digit> A to Z, a to z, 0 to 9, ! " #

\$ % & ' () * + , - . / : ; < = > ? @ [\] ^ _ ` { | } ~

7. After selecting, push [↵].
 - Sets the Symbol into the channel selected in step 1.

Selecting a preset symbol

1. Select the symbol channel, then push [QUICK].
2. Select “Edit Symbol,” then push [↵].
3. Select the symbol, then push [↵].
 - ① 1:Car, 2: Van, 3: Truck, and 4:House QTH (VHF) are set as defaults.
4. Select the symbol channel, then push [↵].

GPS items (Continued)

Symbol list

Symbol No.1 1/38 [/ I] Sheriff [/ #] Digipeater	Symbol No.1 14/38 [/ Y] Yacht [/] Person	Symbol No.1 27/38 [\ >] Overlaid Car [\ L] Lighthouse
Symbol No.1 2/38 [/ &] Gateway [/ '] Small Aircraft	Symbol No.1 15/38 [\ /] DF station [/ '] Large Aircraft	Symbol No.1 28/38 [\ S] Satellite [\ U] Sunny
Symbol No.1 3/38 [/ +] Red Cross [/ -] House QTH (VHF)	Symbol No.1 16/38 [\ W] WX Station [/ '] Dish Antenna	Symbol No.1 29/38 [\ W] Overlaid WX Service [\ Y] Radio
Symbol No.1 4/38 [/ .] X [/] Red Dot	Symbol No.1 17/38 [/ a] Ambulance [/ b] Bicycle	Symbol No.1 30/38 [I Y] Icom Radio [\ '] Aircraft
Symbol No.1 5/38 [/ :] Fire [/ ;] Campground	Symbol No.1 18/38 [/ f] Fire Truck [/ g] Glider	Symbol No.1 31/38 [\] Overlaid WX Station [\ a] Overlaid Diamond
Symbol No.1 6/38 [/ <] Motorcycle [/ =] Railroad Engine	Symbol No.1 19/38 [/ h] Hospital [/ j] Jeep	Symbol No.1 32/38 [\ c] RACES [\ g] Gale Flags
Symbol No.1 7/38 [/ >] Car [/ C] Canoe	Symbol No.1 20/38 [/ k] Truck [/ n] Node	Symbol No.1 33/38 [\ h] Ham Store [\ j] Work Zone
Symbol No.1 8/38 [/ E] Eyeball [/ K] School	Symbol No.1 21/38 [/ p] Rover [/ r] Repeater	Symbol No.1 34/38 [\ m] Speed post(Value Signpost) [\ n] Triangle
Symbol No.1 9/38 [/ L] PC User [/ 0] Balloon	Symbol No.1 22/38 [/ s] Ship(powerboat) [/ u] Truck(18-wheeler)	Symbol No.1 35/38 [\ o] Small Circle [\ s] Overlaid Ship
Symbol No.1 10/38 [/ P] Police [/ R] Recreational Vehicle	Symbol No.1 23/38 [/ v] Van [/ y] Yagi @ QTH	Symbol No.1 36/38 [\ t] Tornado [\ u] Overlaid Truck
Symbol No.1 11/38 [/ S] Shuttle [/ T] SSTV	Symbol No.1 24/38 [\ #] Overlaid Digipeater [\ &] Overlaid Gateway	Symbol No.1 37/38 [\ v] Overlaid Van [\ x] Wreck
Symbol No.1 12/38 [/ U] Bus [/ V] ATV	Symbol No.1 25/38 [\ -] House (HF) [\ .] Big Question Mark	Symbol No.1 38/38 [/ '] Other
Symbol No.1 13/38 [\ W] WX Service [/ X] Helicopter	Symbol No.1 26/38 [\ 0] Circle [\ ;] Park/Picnic Area	

GPS items (Continued)

SSID (Default: ---)

GPS > GPS TX Mode > D-PRS > TX Format > Position > **SSID**

Select an SSID based on APRS® to add to your call sign, to show your operating style to other stations. The addition methods of the SSID may differ, depending on whether the call sign includes a space or not.

- ---: The space in call sign is converted to “-.”
If no text is entered after the space, the space will be deleted, and the space is not converted to “-.”
Example: JA3YUA → JA3YUA
JA3YUA **A** → JA3YUA-**A**
- (-0): No SSID is added. If a call sign includes a space, any text or digit after the space will be deleted.
Example: JA3YUA → JA3YUA
JA3YUA **A** → JA3YUA
- -1~-15: Adds an SSID of -1 to -15 to your call sign.
Example: SSID is “-9.”
JA3YUA → JA3YUA-**9**
JA3YUA **A** → JA3YUA-**9**
- -A~-Z: Adds an SSID of -A to -Z to your call sign.
Example: SSID is “-Z.”
JA3YUA → JA3YUA-**Z**
JA3YUA **A** → JA3YUA-**Z**

About the SSID

To assist in identifying a station’s type, designated call sign SSIDs are used in D-PRS (or APRS®), according to a common guideline. The guideline may be changed when the infrastructure environment, such as a product or network, is changed. Please check the latest guideline in the web site related to D-PRS and APRS®, and correctly set.

Comment

GPS > GPS TX Mode > D-PRS > TX Format > Position > **Comment**

Enter a comment to transmit it with the D-PRS position data. You can enter up to four comments. The number of characters you can enter differs, depending on the Data Extension and Altitude settings.

Data Extension	Altitude	Characters entered (Max.)
OFF	OFF	43 (Default)
OFF	ON	35
Course/Speed	OFF	36
Course/Speed	ON	28
Power/Height/Gain/Directivity	OFF	36
Power/Height/Gain/Directivity	ON	28

The symbol “J” displays the transmittable comment range. Please note that the characters that exceed the range will not be transmitted.

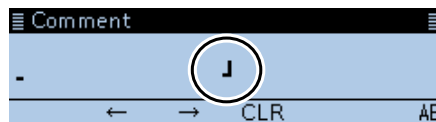

Transmittable comment range display (In case of up to 28 characters)

Time Stamp (Default: OFF)

GPS > GPS TX Mode > D-PRS > TX Format > Position > **Time Stamp**

Sets the transmitting time stamp type to DHM, HMS or OFF.

The time stamp is transmitted along with the position data in the D-PRS mode, and UTC (Universal Time Coordinated) time is used.

- OFF: Does not transmit the time information.
- DHM: Transmits the time stamp in the Day, Hour, and Minute format.
- HMS: Transmits the time stamp in the Hour, Minute, and Second format.

When your location is manually set, time stamp data cannot be transmitted.

GPS items (Continued)

Altitude (Default: OFF)

GPS > GPS TX Mode > D-PRS > TX Format > Position > **Altitude**

Select whether or not to transmit altitude data along with the position data in the D-PRS mode.

- OFF: No altitude data is transmitted.
- ON: Transmits altitude data along with the position data.

TIP: The number of characters you can enter in "Comment" differs, depending on the "Data Extension" and "Altitude" settings.

Data Extension (Default: OFF)

GPS > GPS TX Mode > D-PRS > TX Format > Position > **Data Extension**

Select whether or not to transmit course/speed data or Power/Height/Gain/Directivity data along with the position data in the D-PRS mode.

- OFF: Does not transmit any information.
- Course/Speed: Transmits course and speed data along with the position data. The Course and Speed data is not transmitted when your location is manually set. When transmitting with this setting, your station is regarded as a mobile station.
- Power/Height/Gain/Directivity: Transmits the TX power level, height, antenna gain and antenna direction, along with the position data. The Power, Height, Gain and Directivity data is transmitted even if your location is manually set. Only the Icom transceivers, ID-51A/E PLUS, ID-51A/E PLUS2, ID-5100A/E, and ID-4100A/E, can receive Power, Height, Gain and Directivity data. (As of April 2017)

TIP: The number of characters you can enter in "Comment" differs, depending on the "Data Extension" and "Altitude" settings.

Power (Default: 0W)

GPS > GPS TX Mode > D-PRS > TX Format > Position > **Power**

Select the TX power level of the base station, to transmit along with the position data.

Options: Set to between 0, 1, 4, 9, 16, 25, 36, 49, 64, and 81W.

- ① This item is displayed when "Data Extension" is set to "Power/Height/Gain/Directivity."

Height (Default: 10ft)

GPS > GPS TX Mode > D-PRS > TX Format > Position > **Height**

Select the height of the base station's antenna, to transmit along with the position data.

Options: Set to between 10, 20, 40, 80, 160, 320, 640, 1280, 2560, and 5120 feet.*

*If the Altitude/Distance unit is set to "m," select between 3, 6, 12, 24, 49, 98, 195, 390, 780, and 1561 meters. (p. 9-64)

- ① This item is displayed when "Data Extension" is set to "Power/Height/Gain/Directivity."

Gain (Default: 0dB)

GPS > GPS TX Mode > D-PRS > TX Format > Position > **Gain**

Select the gain of the base station's antenna, to transmit along with the position data.

Options: Set to between 0 and 9 dB.

- ① This item is displayed when "Data Extension" is set to "Power/Height/Gain/Directivity."

Directivity (Default: Omni)

GPS > GPS TX Mode > D-PRS > TX Format > Position > **Directivity**

Select the direction the base station's antenna was pointing, to transmit along with the position data.

Options: Set to between Omni, 45°NE, 90°E, 135°SE, 180°S, 225°SW, 270°W, 315°NW and 360°N.

- ① This item is displayed when "Data Extension" is set to "Power/Height/Gain/Directivity."

GPS items (Continued)

Object Name

GPS > GPS TX Mode > D-PRS > TX Format > Object > **Object Name**

Enter an Object name of up to 9 characters.

Data Type (Default: Live Object)

GPS > GPS TX Mode > D-PRS > TX Format > Object > **Data Type**

Set the Object's status.

- Live Object: The Object is valid.
- Killed Object: The Object is invalid.

Symbol (Default: Radio)

GPS > GPS TX Mode > D-PRS > TX Format > Object > **Symbol**

The symbol is an icon which represents Object's means of transportation or location. The saved symbol is transmitted along with the position data while in the D-PRS mode.

See page 9-25 for the symbol list.

Editing a symbol

1. Push [QUICK].
2. Rotate [DIAL] to select "Direct Input," then push [↵].
3. Push [MW] to move the cursor to the second digit, or push [MODE] to move the cursor to the first digit.
4. Rotate [DIAL] to select a character or symbol to the selected digit.

Selectable characters and symbols
<p><For the first digit> /, \, 0 to 9, A to Z</p>
<p><For the second digit> A to Z, a to z, 0 to 9, !"# \$ % & ' () * + , - . / : ; < = > ? @ [\] ^ _ ` { } ~</p>

5. Push [↵] to set the symbol.

Selecting a preset symbol

1. On the "Symbol" screen, rotate [DIAL] to select the symbol.
2. Push [↵] to set the symbol.

Comment

GPS > GPS TX Mode > D-PRS > TX Format > Object > **Comment**

Enter a comment.

The number of characters you can enter differs, depending on the Data Extension and Altitude data entry.

Data Extension	Altitude	Characters entered (maximum)
OFF	—	43 (Default)
OFF	Entered	35
Course/Speed	—	36
Course/Speed	Entered	28
Power/Height/Gain/Directivity	—	36
Power/Height/Gain/Directivity	Entered	28

The symbol "J" shows the transmittable comment range. Please note that the characters that exceed the range will not be transmitted.



Transmittable comment range display (In case of up to 28 characters)

GPS items (Continued)

Position

GPS > GPS TX Mode > D-PRS > TX Format > Object > **Position**

Displays the position information of the Object.
Push [QUICK] to open the window shown below.

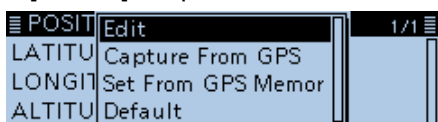

TIP: When you select “Capture From GPS” or “Set From GPS Memory,” you can capture the position from the GPS, or set the Object’s position from the GPS memory. (p. 5-18)

Entering the latitude

1. Rotate [DIAL] to select “Edit,” then push [↵].
 - Displays the POSITION EDIT screen.
2. Select “LATITUDE,” then push [↵].
 - Displays the LATITUDE screen.
3. Rotate [DIAL] to enter the latitude.
 - ① Push [MW] to move the cursor forwards, or push [MODE] to move the cursor backwards.
 - ① To enter a north latitude, select “N,” and to enter a south latitude, select “S.”
4. After entering, push [↵].

Entering the longitude

5. Select “LONGITUDE,” then push [↵].
 - Displays the LONGITUDE screen.
6. Rotate [DIAL] to enter the longitude.
 - ① Push [MW] to move the cursor forwards, or push [MODE] to move the cursor backwards.
 - ① To enter an east longitude, select “E,” and to enter a west longitude, select “W.”
7. After entering, push [↵].

Entering the altitude

8. Select “ALTITUDE,” then push [↵].
 - Displays the ALTITUDE screen.
9. Rotate [DIAL] to select between plus and minus.
10. Push [MW] to move the cursor forwards.
11. Rotate [DIAL] to enter the altitude.
 - ① Push [MW] to move the cursor forwards, or push [MODE] to move the cursor backwards.
12. After entering, push [↵].
13. Select “<<Write>>,” then push [↵].
 - The confirmation dialog “Write?” is displayed.
14. Select <YES>, then push [↵].
 - Writes the entered position data.
15. Push [↵].

TIP: The number of characters you can enter in “Comment” differs, depending on the “Data Extension” and “Altitude” settings.

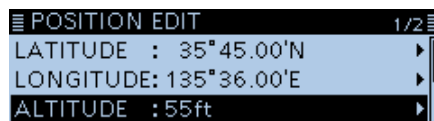

After entering the position data

Data Extension (Default: OFF)

GPS > GPS TX Mode > D-PRS > TX Format > Object > **Data Extension**

Select whether or not to transmit the Course/Speed data or Power/Height/Gain/Directivity data along with the position data in the D-PRS mode.

- OFF: Does not transmit any information.
- Course/Speed: Transmits the Course and Speed data along with the position data.
- Power/Height/Gain/Directivity: Transmits the Power, Height, Gain and Directivity data, along with the position data. Only the Icom transceivers, ID-51A/E PLUS, ID-51A/E PLUS2, ID-5100A/E, and ID-4100A/E, can receive Power, Height, Gain and Directivity data. (As of April 2017)

TIP: The number of characters you can enter in “Comment” differs, depending on the “Data Extension” and “Altitude” settings.

Course (Default: 0°)

GPS > GPS TX Mode > D-PRS > TX Format > Object > **Course**

Set the Object’s course to between 0° and 360°.

- ① This item is displayed when “Data Extension” is set to “Course/Speed.”

Speed (Default: 0mph)

GPS > GPS TX Mode > D-PRS > TX Format > Object > **Speed**

Set the Object’s speed to between 0 and 1150 mph.*
*If the Speed unit is set to “km/h,” select between 0 to 1850 km/h, or set to “knots,” select between 0 and 999 knot. (p. 9-64)

- ① This item is displayed when “Data Extension” is set to “Course/Speed.”

GPS items (Continued)

Power (Default: 0W)

GPS > GPS TX Mode > D-PRS > TX Format > Object > **Power**

Select the TX power level of the Object, to transmit along with the position data.
Options: Set to between 0, 1, 4, 9, 16, 25, 36, 49, 64, and 81W.
① This item is displayed when "Data Extension" is set to "Power/Height/Gain/Directivity."

Height (Default: 10ft)

GPS > GPS TX Mode > D-PRS > TX Format > Object > **Height**

Select the height of the Object's antenna, to transmit along with the position data.
Options: Set to between 10, 20, 40, 80, 160, 320, 640, 1280, 2560, and 5120 feet.*
*If the Altitude/Distance unit is set to "m," select between 3, 6, 12, 24, 49, 98, 195, 390, 780, and 1561 meters. (p. 9-64)
① This item is displayed when "Data Extension" is set to "Power/Height/Gain/Directivity."

Gain (Default: 0dB)

GPS > GPS TX Mode > D-PRS > TX Format > Object > **Gain**

Select the gain of the Object's antenna, to transmit along with the position data.
Options: Set to between 0 and 9 dB.
① This item is displayed when "Data Extension" is set to "Power/Height/Gain/Directivity."

Directivity (Default: Omni)

GPS > GPS TX Mode > D-PRS > TX Format > Object > **Directivity**

Select the direction the Object's antenna was pointing, to transmit along with the position data.
Options: Set to between Omni, 45°NE, 90°E, 135°SE, 180°S, 225°SW, 270°W, 315°NW and 360°N.
① This item is displayed when "Data Extension" is set to "Power/Height/Gain/Directivity."

SSID (Default: ---)

GPS > GPS TX Mode > D-PRS > TX Format > Object > **SSID**

Select an SSID based on APRS® to add to your call sign, to show your operating style to other stations. The addition methods of the SSID may differ, depending on whether the call sign includes a space or not.

- ---: The space in call sign is converted to "-." If no text is entered after the space, the space will be deleted, and the space is not converted to "-."
Example: JA3YUA → JA3YUA
JA3YUA A → JA3YUA-A
- (-0): No SSID is added. If a call sign includes a space, any text or digit after the space will be deleted.
Example: JA3YUA → JA3YUA
JA3YUA A → JA3YUA
- -1~-15: Adds an SSID of -1 to -15 to your call sign.
Example: SSID is "-9."
JA3YUA → JA3YUA-9
JA3YUA A → JA3YUA-9
- -A~-Z: Adds an SSID of -A to -Z to your call sign.
Example: SSID is "-Z."
JA3YUA → JA3YUA-Z
JA3YUA A → JA3YUA-Z

About the SSID
To assist in identifying a station's type, designated call sign SSIDs are used in D-PRS (or APRS®), according to a common guideline. The guideline may be changed when the infrastructure environment, such as a product or network, is changed. Please check the latest guideline in the web site related to D-PRS and APRS®, and correctly set.

Time Stamp (Default: DHM)

GPS > GPS TX Mode > D-PRS > TX Format > Object > **Time Stamp**

Sets the transmitting time stamp type to DHM or HMS. The time stamp is transmitted along with the position data in the D-PRS mode, and UTC (Universal Time Coordinated) time is used.

- DHM: Transmits the time stamp in the Day, Hour, and Minute format.
- HMS: Transmits the time stamp in the Hour, Minute, and Second format.

GPS items (Continued)

Item Name

GPS > GPS TX Mode > D-PRS > TX Format > Item > **Item Name**

Enter an Item name of up to 9 characters.

Data Type (Default: Live Item)

GPS > GPS TX Mode > D-PRS > TX Format > Item > **Data Type**

Set the Item's status.

- Live Item: The Item is valid.
- Killed Item: The Item is invalid.

Symbol (Default: Radio)

GPS > GPS TX Mode > D-PRS > TX Format > Item > **Symbol**

The symbol is an icon which represents Item's means of transportation or location. The saved symbol is transmitted along with the position data while in the D-PRS mode.

See page 9-25 for the symbol list.

Editing a symbol

1. Push [QUICK].
2. Rotate [DIAL] to select "Direct Input," then push [↵].
3. Push [MW] to move the cursor to the second digit, or push [MODE] to move the cursor to the first digit.
4. Rotate [DIAL] to select a character or symbol to the selected digit.

Selectable characters and symbols
<For the first digit> /, \, 0 to 9, A to Z
<For the second digit> A to Z, a to z, 0 to 9, !"# \$ % & ' () * + , - . / : ; < = > ? @ [\] ^ _ ` { } ~

5. Push [↵] to set the symbol.

Selecting a preset symbol

1. On the "Symbol" screen, rotate [DIAL] to select the symbol.
2. Push [↵] to set the symbol.

Comment

GPS > GPS TX Mode > D-PRS > TX Format > Item > **Comment**

Enter a comment.

The number of characters you can enter differs, depending on the Data Extension and Altitude data entry.

Data Extension	Altitude	Characters entered (maximum)
OFF	—	43 (Default)
OFF	Entered	35
Course/Speed	—	36
Course/Speed	Entered	28
Power/Height/Gain/Directivity	—	36
Power/Height/Gain/Directivity	Entered	28

The symbol "J" shows the transmittable comment range. Please note that the characters that exceed the range will not be transmitted.

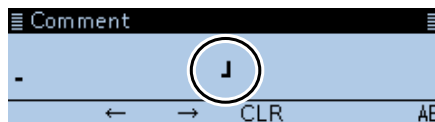

Transmittable comment range display (In case of up to 28 characters)

GPS items (Continued)

Position

GPS > GPS TX Mode > D-PRS > TX Format > Item > **Position**

Displays the position information of the Item.
Push [QUICK] to open the window shown below.

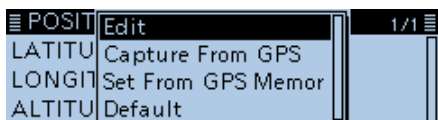

TIP: When you select “Capture From GPS” or “Set From GPS Memory,” you can capture the position from the GPS, or set the Item’s position from the GPS memory. (p. 5-18)

Entering the latitude

1. Rotate [DIAL] to select “Edit,” then push [↵].
 - Displays the POSITION EDIT screen.
2. Select “LATITUDE,” then push [↵].
 - Displays the LATITUDE screen.
3. Rotate [DIAL] to enter the latitude.
 - ① Push [MW] to move the cursor forwards, or push [MODE] to move the cursor backwards.
 - ① To enter a north latitude, select “N,” and to enter a south latitude, select “S.”
4. After entering, push [↵].

Entering the longitude

5. Select “LONGITUDE,” then push [↵].
 - Displays the LONGITUDE screen.
6. Rotate [DIAL] to enter the longitude.
 - ① Push [MW] to move the cursor forwards, or push [MODE] to move the cursor backwards.
 - ① To enter an east longitude, select “E,” and to enter a west longitude, select “W.”
7. After entering, push [↵].

Entering the altitude

8. Select “ALTITUDE,” then push [↵].
 - Displays the ALTITUDE screen.
9. Rotate [DIAL] to select between plus and minus.
10. Push [MW] to move the cursor forwards.
11. Rotate [DIAL] to enter the altitude.
 - ① Push [MW] to move the cursor forwards, or push [MODE] to move the cursor backwards.
12. After entering, push [↵].
13. Select “<<Write>>,” then push [↵].
 - The confirmation dialog “Write?” is displayed.
14. Select <YES>, then push [↵].
 - Writes the entered position data.
15. Push [↵].

TIP: The number of characters you can enter in “Comment” differs, depending on the “Data Extension” and “Altitude” settings.

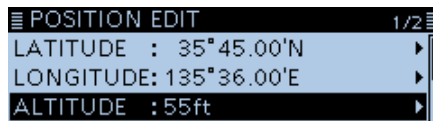

After entering the position data

Data Extension

(Default: OFF)

GPS > GPS TX Mode > D-PRS > TX Format > Item > **Data Extension**

Select whether or not to transmit the Course/Speed data or Power/Height/Gain/Directivity data along with the position data in the D-PRS mode.

- OFF: Does not transmit any information.
- Course/Speed: Transmits the Course and Speed data along with the position data.
- Power/Height/Gain/Directivity: Transmits the Power, Height, Gain and Directivity data, along with the position data. Only the Icom transceivers, ID-51A/E PLUS, ID-51A/E PLUS2, ID-5100A/E, and ID-4100A/E, can receive Power, Height, Gain and Directivity data. (As of April 2017)

TIP: The number of characters you can enter in “Comment” differs, depending on the “Data Extension” and “Altitude” settings.

Course

(Default: 0°)

GPS > GPS TX Mode > D-PRS > TX Format > Item > **Course**

Set the Item’s course to between 0° and 360°.

- ① This item is displayed when “Data Extension” is set to “Course/Speed.”

Speed

(Default: 0mph)

GPS > GPS TX Mode > D-PRS > TX Format > Item > **Speed**

Set the Item’s speed to between 0 and 1150 mph.*

*If the Speed unit is set to “km/h,” select between 0 to 1850 km/h, or set to “knots,” select between 0 and 999 knot. (p. 9-64)

- ① This item is displayed when “Data Extension” is set to “Course/Speed.”

GPS items (Continued)

Power (Default: 0W)

GPS > GPS TX Mode > D-PRS > TX Format > Item > **Power**

Select the TX power level of the Item, to transmit along with the position data.

Options: Set to between 0, 1, 4, 9, 16, 25, 36, 49, 64, and 81W.

① This item is displayed when “Data Extension” is set to “Power/Height/Gain/Directivity.”

Height (Default: 10ft)

GPS > GPS TX Mode > D-PRS > TX Format > Item > **Height**

Select the height of the Item’s antenna, to transmit along with the position data.

Options: Set to between 10, 20, 40, 80, 160, 320, 640, 1280, 2560, and 5120 feet.*

*If the Altitude/Distance unit is set to “m,” select between 3, 6, 12, 24, 49, 98, 195, 390, 780, and 1561 meters. (p. 9-64)

① This item is displayed when “Data Extension” is set to “Power/Height/Gain/Directivity.”

Gain (Default: 0dB)

GPS > GPS TX Mode > D-PRS > TX Format > Item > **Gain**

Select the gain of the Item’s antenna, to transmit along with the position data.

Options: Set to between 0 and 9 dB.

① This item is displayed when “Data Extension” is set to “Power/Height/Gain/Directivity.”

Directivity (Default: Omni)

GPS > GPS TX Mode > D-PRS > TX Format > Item > **Directivity**

Select the direction the Item’s antenna was pointing, to transmit along with the position data.

Options: Set to between Omni, 45°NE, 90°E, 135°SE, 180°S, 225°SW, 270°W, 315°NW and 360°N.

① This item is displayed when “Data Extension” is set to “Power/Height/Gain/Directivity.”

SSID (Default: ---)

GPS > GPS TX Mode > D-PRS > TX Format > Item > **SSID**

Select an SSID based on APRS® to add to your call sign, to show your operating style to other stations. The addition methods of the SSID may differ, depending on whether the call sign includes a space or not.

- ---: The space in call sign is converted to “-.” If no text is entered after the space, the space will be deleted, and the space is not converted to “-.”
Example: JA3YUA → JA3YUA
JA3YUA A → JA3YUA-A
- (-0): No SSID is added. If a call sign includes a space, any text or digit after the space will be deleted.
Example: JA3YUA → JA3YUA
JA3YUA A → JA3YUA
- -1~-15: Adds an SSID of -1 to -15 to your call sign.
Example: SSID is “-9.”
JA3YUA → JA3YUA-9
JA3YUA A → JA3YUA-9
- -A~-Z: Adds an SSID of -A to -Z to your call sign.
Example: SSID is “-Z.”
JA3YUA → JA3YUA-Z
JA3YUA A → JA3YUA-Z

About the SSID

To assist in identifying a station’s type, designated call sign SSIDs are used in D-PRS (or APRS®), according to a common guideline. The guideline may be changed when the infrastructure environment, such as a product or network, is changed. Please check the latest guideline in the web site related to D-PRS and APRS®, and correctly set.

GPS items (Continued)

Symbol (Default: WX Station)

GPS > GPS TX Mode > D-PRS > TX Format > Weather > **Symbol**

The symbol is an icon which represents weather station's means of transportation or location. The saved symbol is transmitted along with the position data while in the D-PRS mode. See page 9-25 for the symbol list.

Editing a symbol

1. Push [QUICK].
2. Rotate [DIAL] to select "Direct Input," then push [↵].
3. Push [MW] to move the cursor to the second digit, or push [MODE] to move the cursor to the first digit.
4. Rotate [DIAL] to select a character or symbol to the selected digit.

Selectable characters and symbols
<p><For the first digit> /, \, 0 to 9, A to Z</p>
<p><For the second digit> A to Z, a to z, 0 to 9, !"# \$ % & ' () * + , - . / : ; < = > ? @ [\] ^ _ ` { } ~</p>

5. Push [↵] to set the symbol.

Selecting a preset symbol

1. On the "Symbol" screen, rotate [DIAL] to select the symbol.
2. Push [↵] to set the symbol.

SSID (Default: ---)

GPS > GPS TX Mode > D-PRS > TX Format > Weather > **SSID**

Select an SSID based on APRS® to add to your call sign, to show your operating style to other stations. The addition methods of the SSID may differ, depending on whether the call sign includes a space or not.

- ---: The space in call sign is converted to "-." If no text is entered after the space, the space will be deleted, and the space is not converted to "-." Example: JA3YUA → JA3YUA
JA3YUA A → JA3YUA-A
- (-0): No SSID is added. If a call sign includes a space, any text or digit after the space will be deleted. Example: JA3YUA → JA3YUA
JA3YUA A → JA3YUA

- -1~-15: Adds an SSID of -1 to -15 to your call sign. Example: SSID is "-9."
JA3YUA → JA3YUA-9
JA3YUA A → JA3YUA-9
- -A~-Z: Adds an SSID of -A to -Z to your call sign. Example: SSID is "-Z."
JA3YUA → JA3YUA-Z
JA3YUA A → JA3YUA-Z

About the SSID
To assist in identifying a station's type, designated call sign SSIDs are used in D-PRS (APRS®), according to a common guideline. The guideline may be changed when the infrastructure environment, such as a product or network, is changed. Please check the latest guideline in the web site related to D-PRS and APRS®, and correctly set.

Comment

GPS > GPS TX Mode > D-PRS > TX Format > Weather > **Comment**

Enter a comment of up to 43 characters.

Time Stamp (Default: DHM)

GPS > GPS TX Mode > D-PRS > TX Format > Weather > **Time Stamp**

Sets the transmitting time stamp type to DHM, HMS or OFF.

The time stamp is transmitted along with the position data in the D-PRS mode, and UTC (Universal Time Coordinated) time is used.

- OFF: Does not transmit the time information.
- DHM: Transmits the time stamp in the Day, Hour, and Minute format.
- HMS: Transmits the time stamp in the Hour, Minute, and Second format.

GPS items (Continued)

GPS Sentence (Default: GGA)

GPS > GPS TX Mode > NMEA > **GPS Sentence**

Select sentences to be transmitted in the GPS mode to transmit position data.
Options: Set to between RMC, GGA, GLL, VTG, GSA and GSV.

Information

- A maximum of four GPS sentences can be set at a time.
- Displays “✓” when the sentence is set to ON.
- Even if the GPS Auto TX Timer is set to “5 sec.,” when 4 sentences are selected, the time the GPS Auto TX Timer is automatically changed to “10 sec.”
- “VTG,” “GSA” and “GSV” sentences will not be transmitted when your position has been manually set.

NOTE: Set the GSV sentence to OFF when sending the GPS message to conventional digital transceivers (IC-2820H, IC-E2820, ID-800H, IC-91AD, IC-E91, IC-V82, IC-U82, IC-2200H). The GSV sentence is incompatible with them. Those transceivers will not display GPS messages properly if sent as a GSV sentence from the ID-4100A/E.

GPS Message

GPS > GPS TX Mode > NMEA > **GPS Message**

Enter a GPS message of up to 20 alphanumeric characters. (p. 5-26)

NOTE: When you do not want to send a message, delete the entered message.

TIP: Contents of GPS sentence

The Time Stamp is shown based on the UTC (Universal Time Coordinated) time.

Sentence	Lat/Lon	Alt	GPS Time Stamp (UTC)	Date (UTC)	Status	2D/3D	COG (True)	SOG (knot)
RMC	✓		✓	✓	✓		✓	✓
GGA	✓	✓	✓		✓			
GLL	✓		✓		✓			
VTG							✓	✓
GSA					✓	✓		
GSV								

Sentence	Others
RMC	Magnetic Variation, Mode Indicator
GGA	Number of used satellites, HDOP, Geoidal separation, Age of Differential GPS data, Differential reference station ID
GLL	Mode Indicator
VTG	COG (Magnetic north), SOG (km/h), Mode Indicator
GSA	PRN number of satellites, PDOP, HDOP, VDOP
GSV	Total number of sentences, Sentence number, Total number of satellites in view, Satellite information (ID, Altitude, Azimuth, S/N)

GPS items (Continued)

GPS Information

GPS > GPS Information

Displays the GPS satellite direction, altitude, satellite number and receiving status. (p. 5-11)

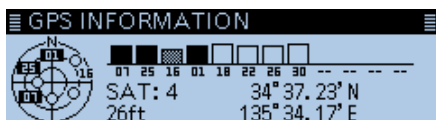

(Example: Tracking 4 satellites)

○	Untracking satellite
Regular characters (Example: 01)	Tracking satellites (weak signal)
Reversed characters (Example: 01)	Tracking satellites (strong signal)
SAT	Number of tracking satellite
Altitude	The altitude of your station. The altitude is only displayed when 4 or more satellites are tracked. When 3 or less satellites are tracked, "-----ft" is displayed.
Latitude	--°--.'-' (Non-positioning)/ Latitude of your station.
Longitude	---°--.'-' (Non-positioning)/ Longitude of your station.

GPS Position

GPS > GPS Position

Your current position, received position or GPS memory alarm position information is displayed. (p. 5-3)

Rotating [DIAL] selects the MY, RX, MEM, and ALM screens.

MY screen (MY Position)

Compass*	Displays your direction
Latitude	Displays your latitude
Longitude	Displays your longitude
GL	Displays the grid locator based on the latitude and longitude of your position.
ALT	Displays your own altitude
SPEED	Displays your speed over ground
TIME	Displays current time received from the GPS
COURSE	Displays your direction heading

① When "GPS Select" is set to "Manual," the screen displays only latitude, longitude, altitude, GL (Grid locator), and time (internal clock).

RX screen (Received position of the other station)

Depending on the caller's TX mode or TX format, the displayed items and these meanings are differ.

The following lists describe the items for each category.

No data is displayed when no position data is received on your transceiver.

<1. When the caller's TX mode is NMEA>

Compass*	Displays the caller's direction from your position.
Latitude	Displays the caller's latitude
Longitude	Displays the caller's longitude
GL	Displays the grid locator based on the latitude and longitude of the caller's position.
ALT	Displays the caller's altitude
DST	Displays the caller's distance from your position
COURSE	Displays the caller's direction over ground
SPEED	Displays the caller's speed
GPS Time Stamp	Displays the time that the caller acquired the position data.
Call sign	Displays the caller's call sign

<2. When the caller's TX format is D-PRS Position (Mobile station)>

Compass*	Displays the caller's direction from your position
Latitude	Displays the caller's latitude
Longitude	Displays the caller's longitude
GL	Displays the grid locator based on the latitude and longitude of the caller's position.
ALT	Displays the caller's altitude
DST	Displays the caller's distance from your position
COURSE	Displays the caller's direction over ground
SPEED	Displays the caller's speed
Symbol	Displays the caller's D-PRS symbol
GPS Time Stamp	Displays the time that the caller acquired the position data.
Call sign	Displays the caller's call sign (with SSID)

*The display type can be changed. (p. 5-10)

GPS items (Continued)

<3. When the caller's TX format is D-PRS Position (Base station)>

Compass*	Displays the caller's direction from your position
Latitude	Displays the caller's latitude
Longitude	Displays the caller's longitude
GL	Displays the grid locator based on the latitude and longitude of the caller's position.
ALT	Displays the caller's altitude
DST	Displays the caller's distance from your position
POWER	Displays the caller's TX power level
HEIGHT	Displays the caller's antenna height
GAIN	Displays the caller's antenna gain
DIRECT	Displays the direction of caller's antenna was pointing
Symbol	Displays the caller's D-PRS symbol
GPS Time Stamp	Displays the time that the caller acquired the position data.
Call sign	Displays the caller's call sign (with SSID)

<4. When the caller's TX format is D-PRS Object/Item>

Compass*	Displays the Object/Item's direction from your position
Latitude	Displays the Object/Item's latitude
Longitude	Displays the Object/Item's longitude
GL	Displays the grid locator based on the latitude and longitude of the Object/Item's position.
ALT	Displays the Object/Item's altitude
DST	Displays the Object/Item's distance from your position
COURSE	Displays the Object/Item's direction over ground
SPEED	Displays the Object/Item's speed
POWER	Displays the Object/Item's TX power level
HEIGHT	Displays the Object/Item's antenna height
GAIN	Displays the Object/Item's antenna gain
DIRECT	Displays the direction that the Object/Item's antenna was pointing
Symbol	Displays the Object/Item's D-PRS symbol
GPS Time Stamp	Displays the time that the caller sent the Object's data.
Call sign	Displays the caller's call sign (with SSID)

① When the object or Item is disabled, "KILLED" is displayed.

<5. When the caller's TX format is D-PRS Weather>

Compass*	Displays the caller's direction from your position
Latitude	Displays the caller's latitude
Longitude	Displays the caller's longitude
GL	Displays the grid locator based on the latitude and longitude of the caller station's position
DST	Displays the caller's distance from your position
TEMP	Displays the temperature of the caller station's area
RAIN	Displays the rainfall of the caller station's area
WIND DIR	Displays the wind direction of the caller station's area
WIND SPD	Displays the wind speed of the caller station's area
BARO	Displays the barometric pressure of the caller station's area
HUMI	Displays the humidity of the caller station's area
Symbol	Displays the caller station's D-PRS symbol
GPS Time Stamp	Displays the time that the caller acquired the weather data.
Call sign	Displays the caller's call sign (with SSID)

MEM screen (GPS memory alarm position)

Compass*	Displays GPS Memory channel's direction from your position
Latitude	Displays GPS Memory channel's latitude
Longitude	Displays GPS Memory channel's longitude
GL	Displays the grid locator based on the latitude and longitude of GPS Memory channel's.
DST	Displays GPS Memory channel's distance from your position
GPS memory name*	Displays the selected GPS memory name

*These items can be selected in the Quick Menu screen.

GPS items (Continued)

ALM screen (GPS alarm position)

Compass*	Displays GPS Alarm area's direction from your position
Latitude	Displays GPS Alarm area's latitude
Longitude	Displays GPS Alarm area's longitude
GL	Displays the grid locator based on the latitude and longitude of GPS Alarm area's.
DST	Displays GPS Alarm area's distance from your position
GPS Alarm*	Displays "RX," GPS memory group name or GPS memory name specified for the GPS alarm function.

GPS Memory

GPS > GPS Memory

The transceiver has 300 GPS Memory channels to save the received position data, or often-used position data, along with an alphanumeric channel name. The channels can be divided into the "(No Group)" group and each memory group (A to Z) for easy memory management.

The display of the GPS memory

(No Group)	GPS memories not assigned to any group.
A ~ Z : Group Name	GPS memories assigned to the selected group.

GPS memory groups (A ~ Z)

GROUP NAME	GPS memory group name (Up to 16 alphanumeric characters)
------------	--

- ① You can edit the GPS memory group name. (p. 5-30)

GPS memory channels

NAME	GPS memory channel name (Up to 16 alphanumeric characters)
DATE	Saved date
TIME	Saved time
LATITUDE	Saved location (latitude)
LONGITUDE	Saved location (longitude)
ALTITUDE	Saved altitude
GROUP	The group letter and the name of the group

- ① When you save the received position data on the GPS POSITION screen, the received station's call sign is used as the GPS memory name.
- ① You can edit the GPS memory contents, such as the GPS memory name. (p. 5-27)

GPS items (Continued)

Alarm Select (Default: OFF)

GPS > GPS Alarm > **Alarm Select**

Select the target position(s) for the GPS alarm function.

- OFF: Turns OFF the function.
- RX: The GPS alarm sounds when a target (the last received position) enters in your active alarm range, .
- Group: The GPS alarm sounds when a target (positions in the GPS memory, or in the selected GPS memory group) enters in your active alarm range.
- Memory: The GPS alarm sounds when a target (the specified position in the GPS memory) enters in the active alarm range.

Alarm Area (Group) (Default: 0.25')

GPS > GPS Alarm > **Alarm Area (Group)**

Set the GPS active alarm range. When a target enters in the specified active alarm range, the GPS alarm sounds and the GPS alarm icon blinks.

① When "Alarm Select" is set to "Group," this setting is enabled.

Ranges differs, depending on the "Position Format" setting.

- Position Format = ddd°mm.mm'
Ranges: 00.08' to 59.99' (0.01' steps)
- Position Format = ddd°mm'ss"
Ranges: 00'05" to 59'59" (0'01" steps)

Example:
When a target enters in the active alarm range, the GPS alarm sounds and the GPS alarm icon blinks.

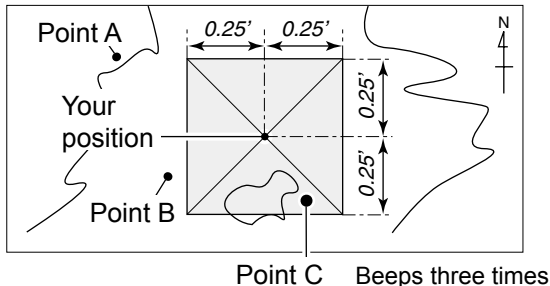

Alarm Area (RX/Memory) (Default: Both)

GPS > GPS Alarm > **Alarm Area (RX/Memory)**

Select the GPS active alarm range. When a target enters in the active alarm range, the GPS alarm sounds and the GPS alarm icon blinks.
① When "Alarm Select" is set to "RX" or "Memory," this setting is enabled.

- Limited: The transceiver sounds 3 beeps and the GPS alarm icon blinks when the target enters the 500 meter range.
- Extended: The transceiver sounds 3 beeps and the GPS alarm icon blinks when the target enters the 1 kilometer range.
- Both: The transceiver sounds a beep and the GPS alarm icon blinks when the target enters the 1 kilometer range, and sounds 3 beeps and the icon blinks when it enters the 500 meter range. When the target exits the 500 meter range, but is still in the 1 kilometer range, the icon continues to blink, but no beeps sound.

Example:
When a target enters in the active alarm range (500 meter or 1 kilometer range, depending on the setting), the GPS alarm sounds and the GPS alarm icon blinks.

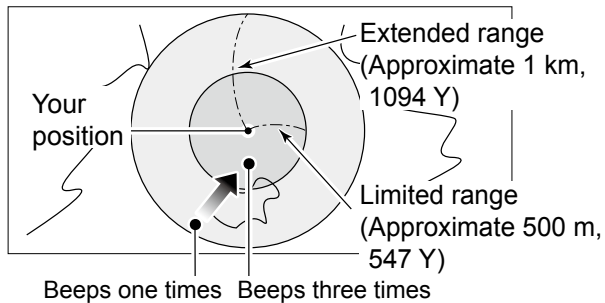

GPS items (Continued)

GPS Logger (Default: OFF)

GPS > GPS Logger > **GPS Logger**

Turn the GPS Logger function ON or OFF. This function logs the position, altitude, course, speed and number of satellites being used.

- OFF: Turns OFF the function.
- ON: The transceiver automatically logs GPS data. Once this function is turned ON, the GPS data will be continuously logged until turning it OFF, even if the transceiver power is turned OFF, then ON again.

- ① This function requires a microSD card (User supplied).
- ① When “GPS select” is set to “OFF” or “Manual,” this function does not save the log.

TIP: The log data is saved on the microSD card. The file name is automatically created, as shown below:

- Log start date and time: 1st April 2017 15:30:00
- File name: 20170401_153000.log

Record Interval (Default: 5sec)

GPS > GPS Logger > **Record Interval**

Select the GPS Logger function record interval of 1, 5, 10, 30, or 60 seconds.

Record Sentence (Default: RMC/GGA/VTG/GSA)

GPS > GPS Logger > **Record Sentence**

Set the GPS Logger function record sentence to RMC, GGA, VTG, or GSA.

- Displays “✓” when the sentence is set to ON.

NOTE: Select at least one sentence, otherwise an error beep will sound.

GPS Auto TX (Default: OFF)

GPS > **GPS Auto TX**

Select an option for the GPS automatic transmission function.

This function automatically transmits the current position data received from a GPS receiver, as well as any entered GPS message, at the selected interval.

- OFF: Does not automatically transmit the position data. (When you push [PTT], the transceiver transmits the position data.)
- 5 sec to 30 min: Transmits the current position data at the selected interval (5*, 10, or 30 seconds, or 1, 3, 5, 10, or 30 minutes).

*Not displayed when you set four GPS sentences in “GPS Sentence.”

NOTE: When the GPS transmit mode is “NMEA,” set the “GPS Select” item to “Internal GPS” or “External GPS.” If you set to “Manual” or “OFF,” the current position data will not be automatically transmitted.

Call Sign items

Call Sign

Call Sign

Sets or views the “UR,” “R1,” “R2,” and “MY” call signs to use in the DV mode.

When not using the DR function, sets the call signs on this screen.

For Simplex operation (DV mode)

You can set the “UR” and “MY” call signs.

For Duplex (repeater) operation (DV mode/DR function)

You can set only “MY” call sign when the DR function is ON.

<To manually set the Duplex (repeater) operation>

Example: Making a gateway CQ call to Hamacho repeater (JP1YIU A) from the Hirano repeater (JP3YHH A), in the DV mode.

- ① Before starting to set the call sign, set the frequency of your access repeater and duplex direction on the standby screen. (Section 4)

TIP: When the DR function is ON, the repeater call sign is automatically set. (p. 9-49)

Step 1. Setting the call sign “R1”

1. Rotate [DIAL] to select “R1.”
2. Push [QUICK]
3. Select “Edit,” then push [↵].
4. Rotate [DIAL] to enter the first character.
 - ① Selectable characters are Alphanumeric characters and symbol (“/”)
5. Push [MW] to move the cursor forwards, or push [MODE] to move the cursor backwards.
6. Repeat steps 4 and 5 to enter the repeater call sign of up to 8 characters, including a space.

(Example: JP3YHH A)
7. After entering, push [↵].

Step 2. Gateway “R2” setting

1. Select “R2,” then push [↵].
 - ① To manually enter the call sign, push [QUICK], then select “Edit.”
2. Select “GW,” then push [↵].

About the RPT2 SELECT screen

NOT USED*	For local area call
GW	To select the gateway call sign from the repeater list.
Repeater name	To select the repeater that has the same gateway as the “R1” repeater.

Step 3. Destination “UR” setting

1. Select “UR,” then push [↵].
 - ① To manually enter the call sign, push [QUICK], then select “Edit.”
2. Select “Gateway CQ,” then push [↵].
3. Select repeater group where your destination repeater is listed, then push [↵].

(Example: 11:Japan)
4. Select the repeater, then push [↵].

(Example: Hamacho)

About the YOUR SELECT screen

CQCQCQ	To select “CQCQCQ” to make a non-call sign specific call.
Gateway CQ*	To select “Gateway CQ” to make a call using the repeater list.
Your Call Sign	To select the destination “UR” call sign using the Your Call Sign memory.
RX History	To select the destination “UR” call sign using the RX History.
TX History	To select the destination “UR” call sign using the TX History.

*Not displayed in the Simplex mode.

RX History items

RX History

RX History

When a call is received in the DV mode, the call information such as the caller station's call sign, the repeater's call sign, and so on, are saved on this screen. Up to 50 records can be saved.

① Even if the transceiver is OFF, the saved records are not deleted.

TIP: To display the RX record contents

On the RX HISTORY screen, rotate [DIAL] to display the RX record contents (RX01 ~ RX50).

Contents of the RX History Top screen

RX01 ~ RX50	RX history number
CALLER*1	Displays the caller station's name*2.
CALLED*1	Displays the called station's name*2.
MESSAGE	Displays any message included in the received call, if entered.
RX TIME	Displays the date and time the call was received.
[GW]	Displays when a call is received through the internet.
[GPS]	Displays when position data is included. (NMEA or Mobile/Base station)
[OBJ]	Displays when the Object's data is included.
[ITEM]	Displays when the Item's data is included.
[WX]	Displays when the weather station's data is included.
(UP)	Displays when an uplink signal is received.

*1 These items can be changed to the call sign display. In that case, the call sign and a note that is entered after the call sign are displayed.

*2 If the name is not entered, the call sign and a note that is entered after the call sign are displayed.

*3 "FREQUENCY" is displayed instead of these items when the call was not through a repeater (Simplex call), to show the frequency that was used.

*4 If you have no position data, these items are not displayed.

Contents of the detail screen

The contents of the detail screen differ, whether the position data is included in the received data or not. The position data that is included in the received data can be divided into five categories. Depending on the caller's TX mode or TX format, the displayed items and these meanings differ.

The following lists show the items for each category.

① No data is displayed when no position data is received.

TIP: On the RX HISTORY screen, push [↵] to display the detail screen.

Common items

CALLER*1	Displays the caller station's name*2.
CALLED*1	Displays the called station's name*2.
RXRPT1*1, *3	Displays the name of the repeater that was accessed by the caller station. If it was a call through a gateway and the internet, this item displays the gateway repeater name of your local area repeater.
RXRPT2*1, *3	Displays the name of the repeater you received the call from.
RX MESSAGE	Displays any message included in the received call, if entered.
RX TIME	Displays the date and time the call was received.

<1. When the caller's TX mode is NMEA>

Compass*4	Displays the caller's direction from your position
Latitude	Displays the caller's latitude
Longitude	Displays the caller's longitude
GL	Displays the grid locator based on the caller's latitude and longitude
ALT	Displays the caller's altitude
DIST*4	Displays the caller's distance from your position
COURSE	Displays the caller's direction over ground
SPEED	Displays the caller's speed
GPS Time Stamp	Displays the time that the caller acquired the position data.
Call sign	Displays the caller's call sign
GPS MESSAGE	Displays the GPS message included in the position data of the received call.

RX History items (Continued)

<2. When the caller's TX format is D-PRS Position (Mobile station)>

Compass*	Displays the caller's direction from your position
Latitude	Displays the caller's latitude
Longitude	Displays the caller's longitude
GL	Displays the grid locator based on the caller's latitude and longitude
ALT	Displays the caller's altitude
DIST*	Displays the caller's distance from your position
COURSE	Displays the caller's direction over ground
SPEED	Displays the caller's speed
GPS Time Stamp	Displays the time that the caller acquired the position data.
Call sign	Displays the caller's call sign (with SSID)
Symbol	Displays the caller's D-PRS symbol
GPS MESSAGE	Displays the GPS message included in the position data of the received call.

<3. When the caller's TX format is D-PRS Position (Base station)>

Compass*	Displays the caller's direction from your position
Latitude	Displays the caller's latitude
Longitude	Displays the caller's longitude
GL	Displays the grid locator based on the caller's latitude and longitude
ALT	Displays the caller's altitude
DIST*	Displays the caller's distance from your position
POWER	Displays the caller's TX power level
HEIGHT	Displays the height of caller's antenna
GAIN	Displays the gain of caller's antenna
DIRECT	Displays the direction that the caller's antenna was pointing
GPS Time Stamp	Displays the time that the caller acquired the position data.
Call sign	Displays the caller's call sign (with SSID)
Symbol	Displays the caller's D-PRS symbol
GPS MESSAGE	Shows the GPS message included in the position data of the received call.

<4. When the caller's TX format is D-PRS Object/Item>

Compass*	Displays the Object/Item's direction from your position
Latitude	Displays the Object/Item's latitude
Longitude	Displays the Object/Item's longitude
GL	Displays the grid locator based on the Object/Item's latitude and longitude
ALT	Displays the Object/Item's altitude
DIST*	Displays the Object/Item's distance from your position
COURSE	Displays the Object/Item's direction over ground
SPEED	Displays the Object/Item's speed
POWER	Displays the Object/Item's TX power level
HEIGHT	Displays the height of Object/Item's antenna
GAIN	Displays the gain of Object/Item's antenna
DIRECT	Displays the direction that the Object/Item's antenna was pointing
GPS Time Stamp	Displays the time that the caller sent the Object's data.
Call sign	Displays the caller's call sign (with SSID)
Symbol	Displays the Object/Item's D-PRS symbol
Status	Displays "KILLED" when the object or Item station is disabled.
GPS MESSAGE	Displays the GPS message included in the position data of the received call.

*If you have no position data, these items are not displayed.

RX History items (Continued)

<5. When the caller's TX format is D-PRS Weather>

Compass*	Displays the caller's direction from your position
Latitude	Displays the caller's latitude
Longitude	Displays the caller's longitude
GL	Displays the grid locator based on the caller's latitude and longitude
DIST*	Displays the caller's distance from your position
TEMP	Displays the temperature of the caller's area
RAIN	Displays the rainfall of the caller's area
WIND DIR	Displays the wind direction of the caller's area
WIND SPD	Displays the wind speed of the caller's area
BARO	Displays the barometric pressure of the caller's area
HUMI	Displays the humidity of the caller's area
Symbol	Displays the caller's D-PRS symbol
GPS Time Stamp	Displays the time that the caller acquired the position data.
GPS MESSAGE	Shows the D-PRS comment included in the position data of the received call.
Call sign	Displays the caller's call sign (with SSID)

*If you have no position data, these items are not displayed.

DV Memory items

Your Call Sign

DV Memory > Your Call Sign

The transceiver has a total of 300 memories to save an individual station call sign.

The saved call sign and name are displayed on the YOUR CALL SIGN or RX HISTORY screen.

- ① You can enter the Your (UR) Call Sign into the Memory using the RX History. (p. 4-10)
- ① To add, edit or move the Your Call Sign in the memory, see pages 4-43 ~ 4-45 for details.

Repeater List

DV Memory > Repeater List

You can save repeater information for quick and simple communication when using repeaters. The transceiver has a total of 1500 repeater memory channels, storable in 50 groups (01 to 50).

NOTE: For easy operation, a repeater list is preloaded into your transceiver. However, if the CPU clears all entered contents (All Reset), the repeater list is also cleared. We recommend that memory data be backed up using a microSD card, or be saved to a PC using the CS-4100 CLONING SOFTWARE.

TIP: About the repeater list

The repeater list can be downloaded from the Icom website.
<http://www.icom.co.jp/world/support/download/firm/index.html>

Repeater Group (01 ~ 50)

Group name	Repeater group name of up to 16 alphanumeric characters
------------	---

You can set the Skip setting. (p. 4-40)

Repeater List

<DV Repeater>

TYPE	DV Repeater
NAME	Repeater name of up to 16 alphanumeric characters
SUB NAME	Repeater sub name of up to 8 alphanumeric characters
CALL SIGN	Repeater call sign
GW CALL SIGN	Gateway call sign
GROUP	Repeater group where the repeater is assigned
USE(FROM)	Select whether or not to use the repeater as an access repeater (FROM) in the DR screen
FREQUENCY	Operating frequency of the access repeater
DUP	Duplex setting to use the access repeater
OFFSET FREQ	Frequency offset to use the access repeater
POSITION	Position data accuracy level ("None," "Approximate" or "Exact")
LATITUDE*	Latitude position of the repeater
LONGITUDE*	Longitude position of the repeater
UTC OFFSET	Time difference between UTC (Universal Time Coordinated) and the local time

NOTE: When the repeater is used for a simplex communication, refer to the list below to set the settings.

<DV Simplex>

TYPE	DV Simplex
NAME	Enter the name of up to 16 alphanumeric characters
SUB NAME	Enter the sub name of up to 8 alphanumeric characters
GROUP	Set the repeater group
USE(FROM)	Select whether or not to set in the "FROM" field on the DR screen
FREQUENCY	Frequency to operate simplex
POSITION	Position data accuracy level ("None," "Approximate," or "Exact")
LATITUDE*	Latitude position of the access point
LONGITUDE*	Longitude position of the access point
UTC OFFSET	Time difference between UTC (Universal Time Coordinated) and the local time

* Displayed when "POSITION" is set to "Approximate" or "Exact."

DV Memory items (Continued)

<FM Repeater>

TYPE	FM repeater
NAME	FM repeater name of up to 16 alphanumeric characters
SUB NAME	FM repeater sub name of up to 8 alphanumeric characters
CALL SIGN	FM repeater call sign
GROUP	Repeater group where the repeater is assigned
USE(FROM)	Select whether or not to use the FM repeater as an access repeater (FROM) on the DR screen
FREQUENCY	Operating frequency of the FM repeater
DUP	Duplex setting to use the FM repeater
OFFSET FREQ	Frequency offset to use the FM repeater
MODE	Receiving mode of the FM repeater
TONE	Tone function setting of the FM repeater
REPEATER TONE	FM repeater tone frequency (Tone Encoder) setting of the access repeater.
POSITION	Position data accuracy level ("None," "Approximate" or "Exact")
LATITUDE*	Latitude position of the FM repeater
LONGITUDE*	Longitude position of the FM repeater
UTC OFFSET	Time difference between UTC (Universal Time Coordinated) and the local time

<FM Simplex>

TYPE	FM Simplex
NAME	Enter the name of up to 16 alphanumeric characters
SUB NAME	Enter the sub name of up to 8 alphanumeric characters
GROUP	Set the repeater group
USE(FROM)	Select whether or not to set in the "FROM" field on the DR screen
FREQUENCY	Frequency to operate simplex
MODE	Receiving mode for simplex FM
TONE	Tone function setting for simplex FM
REPEATER TONE	FM simplex tone frequency (Tone Encoder) setting of the access repeater
POSITION	Position data accuracy level ("None," "Approximate" or "Exact")
LATITUDE*	Latitude position of the station
LONGITUDE*	Longitude position of the station
UTC OFFSET	Time difference between UTC (Universal Time Coordinated) and the local time

* Displayed when "POSITION" is set to "Approximate" or "Exact."

My Station items

My Call Sign

My Station > My Call Sign

The transceiver has a total of 6 memories to save your own call signs.

You can enter a call sign of up to 8 digits. Also, a note of up to 4 characters, for operating radio type, area, and so on, can be entered.

- ① See the D-STAR guide for MY call sign entry.
- ① To select other My Call Sign, rotate [DIAL] to select, then push [↵] on the MY CALL SIGN screen.

TX Message

My Station > TX Message

The transceiver has a total of 5 memories to save short messages for simultaneous transmission in the DV mode.

Enter a message of up to 20 alphanumeric characters for each memory.

- ① See page 4-17 for TX message entry.
- ① To select other TX message, rotate [DIAL] to select, then push [↵] on the TX MESSAGE screen.

TIP: To transmit no message, select "OFF."

DV Set items

RX Bass (Default: Normal)

DV Set > Tone Control > RX Bass

Set the received audio bass filter level to Cut, Normal or Boost.

- Cut: Reduces the low frequencies
- Normal: Normal tone balance
- Boost: Increases the low frequencies

RX Treble (Default: Normal)

DV Set > Tone Control > RX Treble

Set the received audio treble filter level to Cut, Normal or Boost.

- Cut: Reduces the high frequencies
- Normal: Normal tone balance
- Boost: Increases the high frequencies

RX Bass Boost (Default: OFF)

DV Set > Tone Control > RX Bass Boost

Turn the received audio Bass Boost function ON or OFF.

This function is separate from the “Boost” setting of the RX Bass.

- OFF: Turns OFF the function.
- ON: This function boosts the received audio bass.

TX Bass (Default: Normal)

DV Set > Tone Control > TX Bass

Set the transmit audio bass filter level to Cut, Normal or Boost.

- Cut: Reduces the low frequencies
- Normal: Normal tone balance
- Boost: Increases the low frequencies

TX Treble (Default: Normal)

DV Set > Tone Control > TX Treble

Set the transmit audio treble filter level to Cut, Normal or Boost.

- Cut: Reduces the high frequencies
- Normal: Normal tone balance
- Boost: Increases the high frequencies

Auto Reply (Default: OFF)

DV Set > Auto Reply

Set the Automatic Reply function to ON, OFF, Voice, Position. This function automatically replies to a call addressed to your own call sign, even if you are away from the transceiver.

- OFF: Turns OFF the function.
- ON: Replies with your own call sign. (No audio reply is sent)
- Voice: Replies with your call sign and any Auto Reply message recorded on the SD (up to 10 seconds).
If no microSD card is inserted, or no message is recorded, only your call sign is transmitted. The transmitted audio can be monitored.
- Position*: Replies with your own call sign and transmits your position data using the internal or external GPS receiver.

*When “GPS Select” is set to “OFF” or “Manual,” the internal GPS receiver is temporarily turned ON.

When “GPS Select” is set to “External GPS,” but if the external GPS receiver is not connected, the internal GPS receiver is temporarily turned ON.

- ① When “ON” or “Voice” is selected, the Automatic reply function is automatically turned OFF when you push [PTT].
When “Position” is selected, the Automatic reply function is not turned OFF, even if you push [PTT].

DV Data TX (Default: Auto)

DV Set > DV Data TX

Select whether to manually or automatically transmit data in the DV mode.

- PTT: Push [PTT] to manually transmit data.
- Auto: When data is input from a PC through the [DATA] jack, the transceiver automatically transmits it.

DV Set items (Continued)

Fast Data (Default: OFF)

DV Set > DV Fast Data > **Fast Data**

Select whether or not to use the DV Fast Data function for data communication in the DV mode.

The DV Fast Data function uses the data and the audio frames to send data approximately 3.5 times faster than the normal speed. So, no audio can be sent.

- OFF: Sends data at the slow speed (approximately 950 bps).
- ON: Sends data at the fast speed (approximately 3480 bps).

① Even if “ON” is selected, while holding down [PTT], the data is sent at the slow speed, because the audio frame is used for the microphone audio transmission and the audio transmission has priority.

The GPS data speed is set in “GPS Data Speed.”

GPS Data Speed (Default: Slow)

DV Set > DV Fast Data > **GPS Data Speed**

Set the GPS data speed when the data is sent using the DV Fast Data function.

① When you send the GPS data to other transceivers that can receive only slow speed data, set to “Slow.”

- Slow: Sends GPS data in the slow speed (approximately 950 bps).
- Fast: Sends GPS data in the fast speed (approximately 3480 bps).

TX Delay (PTT) (Default: 2sec)

DV Set > DV Fast Data > **TX Delay (PTT)**

Set the TX delay time.

In the data communication mode and after releasing [PTT], the transceiver automatically sends the data using the DV Fast Data function for this set period.

- OFF: After releasing [PTT], the transceiver returns to receive.
- 1 ~ 10sec: After releasing [PTT], the transceiver sends data by using the DV Fast Data function for this set period.
The transceiver automatically returns to receive when the TX data is completely sent, or when this set period ends, whichever is sooner.

NOTE: This function is usable only when “DV Data TX” is set to “PTT.”

Digital Monitor (Default: Auto)

DV Set > **Digital Monitor**

Select a receive mode when [MONI] is pushed in the DV mode.

- Auto: Receives in the DV mode or the FM mode, depending on the received signal.
- Digital: Receives in the DV mode.
- Analog: Receives in the FM mode.

Digital Repeater Set (Default: ON)

DV Set > **Digital Repeater Set**

Turn the Digital Repeater Setting function ON or OFF. In any DV mode except when using the DR function, and when accessing a repeater that has a call sign that is different than the transceiver’s setting, this function reads the repeater’s signal and automatically sets the repeater call sign in R1 and R2.

- OFF: Turns OFF the function.
- ON: Automatically sets the repeater call sign.

DV Auto Detect (Default: OFF)

DV Set > **DV Auto Detect**

Turn the DV mode automatic detect function ON or OFF. If you receive an FM signal in the DV mode, this function temporarily switches to the FM mode.

- OFF: Turns OFF the function. The operating mode is fixed to the DV mode.
- ON: Automatically selects the FM mode for temporary operation.

RX Record (RPT) (Default: ALL)

DV Set > **RX Record (RPT)**

The transceiver can record the data of up to 50 individual calls. When the received signal includes a status message (“UR?” or “RPT?”) that is sent back from the access repeater, you can record up to 50 messages, or only the last call, in the Received Call Record.

- ALL: Records up to 50 calls.
- Latest Only: Records only the last call.

DV Set items (Continued)

BK (Default: OFF)

DV Set > **BK**

The Break-in (BK) function enables you to break into a conversation, where the two other stations are communicating with call sign squelch enabled.

- OFF: Turns OFF the function.
- ON: Turns ON the function.

① The BK function is automatically turned OFF when transceiver is turned OFF.

EMR (Default: OFF)

DV Set > **EMR**

The Enhanced Monitor Request (EMR) function enables all transceivers that receive an EMR signal automatically open their squelch to receive the signal.

- OFF: Turns OFF the function.
- ON: Turns ON the function.

① The EMR function is automatically turned OFF when transceiver is turned OFF.

EMR AF Level (Default: 19)

DV Set > **EMR AF Level**

Set the audio output level to between 0 and 32 for when an EMR communication signal is received. When an EMR signal is received, the audio will be heard at the set level, or the [VOL] control level, whichever is higher.

To disable the setting, set to "0."

NOTE: After an EMR signal disappears, the audio level will remain at the EMR level. In this case, rotate [VOL] to adjust the audio level.

SPEECH items

RX Call Sign SPEECH (Default: ON (Kerchunk))

SPEECH > RX Call Sign SPEECH

Turn the RX call sign speech function ON or OFF for calls received in the DV mode.

- OFF: The caller station's call sign is not announced, even when a call is received.
- ON (Kerchunk): The caller station's call sign is announced only when they make a short transmission.
- ON (All): The caller station's call sign is always announced.

① Information

- When the digital squelch function is used, the calling station's call sign is not announced if the received signal is not addressed to your call sign, or does not include a matched digital code.
- When you receive a signal from a repeater ("UR?" or "RPT?"), the caller station's call sign is not announced.
- While scanning, the transceiver resumes the scan during an announcement.
- Even if a note is entered after the call sign, it is not announced.
- When you receive a signal during an announcement, the transceiver cancels announcement, and you can hear the received audio.

RX>CS SPEECH (Default: ON)

SPEECH > RX>CS SPEECH

Turn the RX>CS Speech function ON or OFF. The RX>CS Speech function announces the station call sign that is selected from a Received Call Record by pushing [RX→CS].

- OFF: The station call sign is not announced.
 - ON: The station call sign is announced.
- ① If a call is received during an announcement, the received audio is muted, and audio is not recorded onto the microSD card. If the call sign is announced while recording, the recorded contents are silent during the announcement.

DIAL SPEECH (Default: OFF)

SPEECH > DIAL SPEECH

Turn the Dial Speech function ON or OFF. The Dial Speech function announces the frequency or repeater call sign that is selected by rotating [DIAL].

- OFF: The frequency or repeater call sign is not announced.
- ON: The frequency or repeater call sign is announced, 1 second after rotating [DIAL]. In the VFO, Memory, or Call channel mode, the frequency is announced. When using the DR function, the repeater call sign is announced.

- ① When using the DR function, the frequency is announced if Simplex is selected or the FM repeater does not have a call sign.
- ① When you receive a signal during an announcement, the transceiver cancels announcement, and you can hear the received audio.

MODE SPEECH (Default: ON)

SPEECH > MODE SPEECH

Turn the Operating Mode Speech function ON or OFF. When this function is ON, the selected operating mode is announced.

- OFF: The selected operating mode is not announced.
 - ON: The selected operating mode is announced.
- ① While the VFO scanning, the operating mode is announced when you change the mode.

SPEECH Language (Default: English)

SPEECH > SPEECH Language

Set the speech language to English or Japanese.

Alphabet (Default: Normal)

SPEECH > Alphabet

Select either "Normal" or "Phonetic Code" to announce the alphabet characters.

- Normal: Normal code is used.
(Example: A as eh, B as bee)
- Phonetic Code: Phonetic code is used.
(Example: A as Alfa, B as Bravo)

SPEECH items (Continued)

SPEECH Speed (Default: Fast)

SPEECH > **SPEECH Speed**

Set the speech speed to Slow or Fast.

SPEECH Level (Default: 7)

SPEECH > **SPEECH Level**

Adjust the voice synthesizer volume level to between 0 (OFF), 1 (minimum) and 9 (maximum).
The voice synthesizer audio output level is linked with the [VOL] setting from the minimum audio volume up to the set level.

DTMF items

You can set the DTMF tone code and DTMF memory channel for DTMF tone operation.
See pages 10-8 ~ 10-10 for details.

DTMF Memory (Default: d0)

DTMF > **DTMF Memory**

Shows a list of the DTMF memory channels.
• d0 to d#: DTMF memory channel list

DTMF Speed (Default: 100ms)

DTMF > **DTMF Speed**

Select the DTMF transmit speed.

- 100ms: Transmits the DTMF codes at about 100 milliseconds per code.
5 characters per second.
- 200ms: Transmits the DTMF codes at about 200 milliseconds per code.
2.5 characters per second.
- 300ms: Transmits the DTMF codes at about 300 milliseconds per code.
1.6 characters per second.
- 500ms: Transmits the DTMF codes at about 500 milliseconds per code.
1 character per second.

QSO/RX Log items

QSO Log (Default: OFF)

QSO/RX Log > QSO Log

Select whether or not to make a communication log on a microSD card.

The communication log is made on a microSD card, and saved in the “csv” format.

① This function requires a microSD card (User supplied).

- OFF: The QSO Log function is OFF.
- ON: The transceiver makes a log on the microSD card.
The transceiver starts making a log when you begin talking.

TIP:

- The folder name is automatically created, as [ID-4100\QsoLog].
- The file name is automatically created, as shown below:
Log start date and time: 1st April 2017 15:30:00
File name: 20170401_153000.csv
- The log contents is not displayed on the transceiver.
- You can display the log contents on a PC.

RX History Log (Default: OFF)

QSO/RX Log > RX History Log

Select whether or not to make a DV mode’s receive history log on a microSD card.

The receive history log is made on a microSD card, and saved in the “csv” format.

① This function requires a microSD card (User supplied).

- OFF: The RX History Log function is OFF.
- ON: The transceiver makes a DV mode’s receive history log on the microSD card.
The transceiver starts making a receive history log when you finish talking.

TIP:

- The folder name is automatically created, as [ID-4100\RxLog].
- The file name is automatically created, as shown in the example below:
Log start date and time: 1st April 2017 15:30:00
File name: 20170401_153000.csv
- The log contents is not displayed on the transceiver.
- You can display the log contents on a PC.

Separator/Decimal (Default: Sep [,] Dec [.]*)

QSO/RX Log > CSV Format > Separator/Decimal

Select the separator and the decimal character for the CSV format.

- Sep [,] Dec [.] : Separator is “,” and Decimal is “.”
 - Sep [;] Dec [.] : Separator is “;” and Decimal is “.”
 - Sep [;] Dec [,] : Separator is “;” and Decimal is “,”
- *The default value may differ, depending on the transceiver version.

Date (Default: mm/dd/yyyy*)

QSO/RX Log > CSV Format > Date

Select the date format between “yyyy/mm/dd,” “mm/dd/yyyy” and “dd/mm/yyyy.” (y: year, m: month, d: day)

*The default value may differ, depending on the transceiver version.

QSO/RX Log items (Continued)

The call log contents are shown below:

Contents	Example		Descriptions
TX/RX	TX	RX	Transmission and reception
Date	4/1/2017 13:51:48	4/1/2017 13:51:48	Date and time the call was started.
Frequency	438.010000	438.010000	Operating frequencies (When Duplex is set, the RX frequency is displayed.)
Mode	DV	DV	Operating mode (AM/AM-N/FM/FM-N/DV)
My Latitude	34.764667	34.764667	Your latitude (unit: degree) (+: North latitude, -: South latitude)
My Longitude	135.375333	135.375333	Your longitude (unit: degree) (+: East longitude, -: West longitude)
My Altitude	50.5	50.5	Your altitude (unit: m) Records to one decimal place.
RF Power	Low	(Blank)	TX output power level
S-meter	(Blank)	S0	The relative signal strength of the receive signal (in twelve levels)
RPT Call Sign	JP3YHJ A	JP3YHJ A	Repeater call sign (DV mode only)
TX Call Sign	CQCQCQ	(Blank)	TX Call sign (DV mode only)
RX Call Sign	(Blank)	JA3YUA A/ 4100	RX Call sign (DV mode only)
RX Latitude	(Blank)	34.764667	Caller's latitude, if sent. (unit: degree) (+: North latitude, -: South latitude) Records only when you receive in the DV mode.
RX Longitude	(Blank)	135.375333	Caller's longitude, if sent. (unit: degree) (+: East longitude, -: West longitude) Records only when you receive in the DV mode.
RX Altitude	(Blank)	30.5	Caller's altitude, if sent. (unit: m) Records only when you receive in the DV mode.

QSO/RX Log items (Continued)

The RX log contents are shown below:

Contents	Example	Descriptions
Frequency	438.010000	RX Frequency
Mode	DV	Operating mode (DV mode is fixed)
Caller	JA3YUA A	Call sign of the caller station (up to 8 characters)
/	4100	Note after the call sign (up to 4 characters)
Called	CQCQCQ	Call sign of the called station
Rx RPT1	JP3YHH G	Access repeater call sign of the caller station or the gateway repeater call sign of your local area repeater.
Rx RPT2	JP3YHJ A	Access repeater call sign of the called station
Message	Hello CQ D-STAR!	Message included in the received call (up to 20 characters)
Status	(Blank)	Normal: blank, Uplink: "RPT UP", Access repeater reply: "UR?" or "RPT?"
Received date	4/1/2017 13:51:48	Date and time the call was received Depending on the setting, the format may differ.
BK	*	BK call: "*", Normal call: Blank
EMR	*	EMR call: "*", Normal call: Blank
Latitude	34.764667	Caller's latitude, if sent. (unit: degree) (+: North latitude, -: South latitude)
Longitude	135.375333	Caller's longitude, if sent. (unit: degree) (+: East longitude, -: West longitude)
Altitude	30.5	Caller's altitude, if sent. (unit: m) Records to one decimal place.
SSID	-A	Caller's SSID, if sent. (0, -1 to -15, -A to -Z)
D-PRS Symbol	Car	Icon: Converts to text, None: Code
Course	123	Caller's course (unit: degree)
Speed	23.5	Caller's speed (unit: km/h) Records to one decimal place.
Power	49	TX power (unit: W)
Height	24	Antenna height (unit: m)
Gain	6	Antenna gain (unit: dB)
Directivity	Omni	Antenna directivity (Omni, 45, 90, 135, 180, 225, 270, 315 or 360)
Object/Item Name	HAM FES	Object name or Item name (up to 9 characters)
Data Type	Live Object	Data type of Object or Item (Live or Kill)
Temperature	20.5	Temperature (unit: °C) Records to two decimal places.
Rainfall	253.75	Rainfall (unit: mm) Records to two decimal places.
Rainfall (24 Hours)	253.75	Rainfall (24 Hours) (unit: mm) Records to two decimal places.
Rainfall (Midnight)	253.75	Rainfall (Midnight) (unit: mm) Records to two decimal places.
Wind Direction	315	Wind Direction (unit: degree)
Wind Speed	10.0	Wind Speed (unit: m/s) Records to one decimal place.
Gust Speed	10.0	Gust Speed (unit: m/s) Records to one decimal place.
Barometric	1013.0	Barometric (unit: hPa) Records to one decimal place.
Humidity	85	Humidity (unit: %)
GPS Time Stamp	12:00:00	Time data that the caller station acquires the position data
GPS Message	Osaka City/ ID-4100	Caller is "NMEA": Records the GPS message Caller is "D-PRS": Records the D-PRS comment

Function items

Squelch/ATT Select (Default: S-Meter Squelch)

Function > Squelch/ATT Select

Select the function that varies according to the [SQL] control position.

- OFF: Both the S-Meter Squelch and Attenuator are disabled.
- S-Meter Squelch: The S-Meter Squelch activates and adjusts the squelch level when [SQL] is set between 12 o'clock and the fully clockwise position.
- ATT: The Attenuator is enabled and adjusts the attenuator level when [SQL] is set between 12 o'clock and the fully clockwise position.

Squelch Delay (Default: Short)

Function > Squelch Delay

Set the squelch delay to short or long to prevent repeated opening and closing of the squelch when receiving the same signal.

- Short: Shortens the time until the squelch opens.
- Long: Lengthens the time until the squelch opens.

Fan Control (Default: Auto)

Function > Fan Control

Select the cooling fan control between Slow, Mid, Fast and Auto.

- Slow: The fan rotates slow.
- Mid: The fan rotates at mid speed.
- Fast: The fan rotates fast.
- Auto: The fan automatically turns ON during transmission or when the internal temperature of the transceiver exceeds the preset value. It remains ON until the temperature drops below the value.

Dial Speed-UP (Default: ON)

Function > Dial Speed-UP

Turn the dial speed acceleration ON or OFF. The acceleration automatically speeds up the tuning dial speed when you rapidly rotate [DIAL].

- OFF: Turns OFF the function.
- ON: Turns ON the function.

Auto Repeater (Default: ON (DUP))

Function > Auto Repeater

The Auto repeater function automatically turns the duplex operation and tone encoder* ON or OFF. The offset and repeater tone* are not changed by the auto repeater function. Reset these setting values, if necessary.

① This item is displayed only in the USA version transceiver.

- OFF: Turns OFF the function.
- ON (DUP): Turns ON the duplex operation only. (Default)
- ON (DUP, TONE): Turns ON the duplex operation and tone encoder*.

* The tone encoder will not be turned ON in the DV mode.

Remote MIC Key

Function > Remote MIC Key

The function assignments for [F-1] and [F-2] keys on the supplied HM-207S HAND MICROPHONE (REMOTE-CONTROL) can be changed.

See pages 9-58 ~ 9-59 for the assignable key functions.

- During RX/Standby: The assigned key function is enabled while receiving or in standby.
- During TX: The assigned key function is enabled during transmission.

Up/Down MIC Key

Function > Up/Down MIC Key

The function assignments for the [UP] and [DN] keys on the optional HM-154 HAND MICROPHONE or HM-232 HAND MICROPHONE (SIMPLE) can be changed.

See pages 9-58 ~ 9-59 for the assignable key functions.

- During RX/Standby: The assigned key function is enabled while receiving or in standby.
- During TX: The assigned key function is enabled during transmission.

Function items (Continued)

• During RX/Standby:

●: Default setting ○: Available N/A: Not available

Function	Description	Remote MIC Key		Up/Down MIC Key	
		[F-1]	[F-2]	[UP]	[DN]
---	No function	○	○	○	○
UP	Push to increase the frequency, Memory channel, repeater or station call sign.	N/A	N/A	●	○
DOWN	Push to decrease the frequency, Memory channel, repeater or station call sign.	N/A	N/A	○	●
VOL UP	Push to increase the volume level.	N/A	N/A	○	○
VOL DOWN	Push to decrease the volume level.	N/A	N/A	○	○
SQL UP	Push to increase the squelch level.	N/A	N/A	○	○
SQL DOWN	Push to decrease the squelch level.	N/A	N/A	○	○
Monitor	Push to open or close the squelch.	○	●	○	○
CALL	Push to select a call channel.	N/A	N/A	○	○
MR (000 CH)	In the Memory mode, push to select Memory channel 000.	○	○	○	○
MR (001 CH)	In the Memory mode, push to select Memory channel 001.	○	○	○	○
VFO/MR	Push to select between the VFO mode and the Memory mode.	N/A	N/A	○	○
DR	Push to turn the DR function ON or OFF.	○	○	○	○
FROM/TO (DR)	On the DR screen, push to select between "FROM" and "TO."	○	○	○	○
Home CH	Push to directly select the Home CH that is set to the selected mode (VFO/Memory) or DR screen. While in the CALL CH or Weather channel mode, or when no Home CH is set, an error beep sounds.	N/A	N/A	○	○
BAND/BANK	Push to select an operating band. In the VFO mode, push to change the operating band, and in the Memory Bank mode, push to select Bank A ~ Z, or OFF. ① Only the entered bank is selectable.	N/A	N/A	○	○
SCAN	• Push to start a scan. • While scanning, push to stop the scan.	○	○	○	○
Temporary Skip	Push to set the frequency to be skipped during scanning. The selected frequencies are temporarily skipped for faster scanning.	○	○	○	○
RX>CS	Hold down for 1 second to set the last calling station's call sign to "TO" (destination).	○	○	○	○
SPEECH	Push to announce the frequency, operating mode or call sign. ① In the VFO, Memory or Call channel mode, the frequency and the operating mode are announced. ① In the DR screen, the call sign is announced. If Simplex is selected, the frequency is announced.	○	○	○	○
MODE	Push to change the operating mode.	●	○	○	○
LOW	Push to change the transmit power level.	○	○	○	○
DUP	Push to turn the Duplex mode ON or OFF, and the shift direction to DUP+ or DUP-.	○	○	○	○
PRIO	Push to turn the Priority watch ON or OFF.	○	○	○	○

☞ Continued on the next page

Function items

• During RX/Standby (Continued):

●: Default setting ○: Available N/A: Not available

Function	Description	Remote MIC Key		Up/Down MIC Key	
		[F-1]	[F-2]	[UP]	[DN]
TONE/DSQL	Push to select between tone types. <<MODE>> FM/FM-N TONE: Repeater Tone TSQL (⋅): Pocket Beep with Tone Squelch TSQL: (Tone Squelch) DTCS (⋅): Pocket Beep with DTCS Code Squelch DTCS: DTCS Code Squelch TSQL-R: Reverse Tone Squelch DTCS-R: Reverse DTCS Code Squelch DTCS (T) ("DTCS" blinks): TX:DTCS, RX:OFF TONE (T)/DTCS (R) ("T-DTCS" is displayed, "T" blinks.): TX:TONE, RX:DTCS DTCS (T)/TSQL (R) ("D-TSQL" is displayed, "D" blinks.): TX:DTCS, RX:CTCSS TONE (T)/TSQL (R) ("T-TSQL" is displayed, "T" blinks.): TX:TONE, RX:CTCSS <<MODE>> DV ① You can set this setting on the DR screen. DSQL (⋅): Pocket Beep with Digital Call sign Squelch DSQL: Digital Call sign Squelch CSQL (⋅): Pocket Beep with Digital Code Squelch CSQL: Digital Code Squelch	○	○	○	○
MW	In the VFO mode or on the DR screen, hold down to save the displayed frequency into a Memory blank channel.	○	○	○	○
MUTE	Push to turn the Mute function ON or OFF.	○	○	○	○
Voice TX (T1)	• Push to transmit the voice audio recorded on the microSD card once. • Hold down for 1 second to repeatedly transmit the voice audio. ① This key function can also be used on the DR screen. ① If the voice audio is not saved in the [T1] (Voice memory number for TX) on the Voice TX record screen, this function is disabled.	○	○	○	○
DTMF DIRECT TX	Push to display the DTMF code direct entry mode screen.	○	○	N/A	N/A
T-CALL	Push to transmit a 1750 Hz tone.	○	○	○	○

• During TX:

●: Default setting ○: Available N/A: Not available

Function	Description	Remote MIC Key		Up/Down MIC Key	
		[F-1]	[F-2]	[UP]	[DN]
---	No function	○	●	●	●
LOW	Push to change the transmit power level.	○	○	○	○
Voice TX (T1)	Push to transmit the voice audio recorded on the microSD card once. Hold down for 1 second to repeatedly transmit the voice audio. - To make a repeat transmission, [PTT] must be released.	○	○	○	○
T-CALL	Push to transmit a 1750 Hz tone.	●	○	○	○

Function items (Continued)

One-Touch PTT (Remote MIC) (Default: OFF)

Function > **One-Touch PTT (Remote MIC)**

Set the On-Touch PTT function for the HM-207S. The function enables you to transmit without sequentially holding down the [PTT] button.

- OFF: Push [PTT] to transmit and release to receive.
- ON: Push [PTT] to transmit, then push again to receive.

PTT Lock (Default: OFF)

Function > **PTT Lock**

Turn the PTT lock function ON or OFF. To prevent accidental transmissions, this function disables [PTT].

- OFF: Turns OFF the function.
- ON: Turns ON the function.

Busy Lockout (Default: OFF)

Function > **Busy Lockout**

Turn the busy lockout function ON or OFF. This function inhibits transmission while receiving a signal, or when the squelch is open.

- OFF: Turns OFF the function.
- ON: Turns ON the function.

Time-Out Timer (Default: OFF)

Function > **Time-Out Timer**

To prevent accidental prolonged transmission, the transceiver has a time-out timer. The function inhibits continuous transmissions longer than the set period of time.

- OFF: Turns OFF the function.
- 1 to 30 min: The transmission is cut OFF after the set period of time ends (1, 3, 5, 10, 15 or 30 minutes).

Active band (Default: All)

Function > **Active Band**

Enables continuous frequency selection of the operating frequency across all bands using [DIAL].

- Single: When you rotate [DIAL] on the band edge, the top or bottom frequency in the displayed band is selected.
- ALL: When you rotate [DIAL], the next band is displayed.

- ① To select another band when “Single” is selected, push [QUICK], then select “Band Select.”
- ① This setting is for the [DIAL] operation, so all frequencies are scanned, even if “Single” is selected.

MIC Gain (Default: 2*)

Function > **MIC Gain**

Set the microphone gain to between 1 (minimum) and 4 (maximum), to suit your preference.

Higher values make the microphone more sensitive to your voice.

*The default settings may differ, depending on your transceiver version.

Data Speed (Default: 9600bps)

Function > **Data Speed**

Select the data speed for outputting a GPS information, inputting a weather information, or data communication in the DV mode to 4800 bps or 9600 bps.

CI-V Address (Default: 9Ah)

Function > CI-V > **CI-V Address**

To distinguish equipment, each CI-V transceiver has its own Icom standard address in hexadecimal code. The ID-4100A/E's default address is 9Ah.

When 2 or more ID-4100A/Es are simultaneously controlled by a PC, set a different address for each transceiver between 02h and DFh (hexadecimal).

CI-V Baud Rate (Default: Auto)

Function > CI-V > **CI-V Baud Rate**

Set the CI-V data transfer speed to 4800, 9600, 19200 bps or Auto.

- ① When “Auto” is selected, the baud rate is automatically set, according to the data rate of the controller.

Function items (Continued)

CI-V Transceive (Default: OFF)

Function > CI-V > **CI-V Transceive**

Turn the CI-V Transceive function ON or OFF.

- OFF: Turns OFF the function.
- ON: When you change a setting on one transceiver, the same settings is automatically changed on other connected transceivers or receivers.

CI-V Bluetooth→REMOTE Transceive Address (Default: 00h)

Function > CI-V >

CI-V Bluetooth→REMOTE Transceive Address

If you remotely operate your transceiver using Bluetooth when “CI-V Transceive” is set to ON, the devices in the same system are also externally controlled through the external speaker (REMOTE) jack.

To prohibit the external control of an Icom transceiver, set this value to other than “00h.”

The control signal is output from the external speaker (REMOTE) jack.

Select an address between 00h and DFh.

Power OFF (With No Controller) (Default: ON)

Function > **Power OFF (With No Controller)**

Select whether or not to automatically turn OFF the transceiver when the controller is disconnected from the transceiver.

- OFF: The transceiver power is not turned OFF. To turn OFF the transceiver, turn OFF the DC supply, or disconnect the power cable. When you connect the controller again, the controller may perform incorrectly. This is not the controller’s malfunction.
- ON: The transceiver is automatically turned OFF.

Display items

LCD Backlight Brightness (Default: 4)

Display > LCD Backlight Brightness

Set the LCD backlight brightness level to between 1 (Dark) and 4 (Bright).

LCD Backlight Color (Default: White)

Display > LCD Backlight Color

Set the LCD backlight color to between White, Amber, Green, and Blue.

Key Backlight Brightness (Default: 4)

Display > Key Backlight Brightness

Selects the key backlight brightness level to between 1 (Dark) and 4 (Bright).

Key Backlight Color (Default: White)

Display > Key Backlight Color

Selects the key backlight color to between White, Amber, Green, and Blue.

Night Time Setting (Default: OFF)

Display > Backlight Night Time Setting > Night Time Setting

Select whether or not to reduce the backlight brightness for the nighttime operation.

You can set the nighttime operation start or stop time with "Night Time Start" or "Night Time End."

- OFF: Does not reduce the backlight brightness.
- ON: Reduces the backlight brightness.

Brightness (Default: 2)

Display > Backlight Night Time Setting > Brightness

Select the backlight brightness level for the nighttime operation between 1 (Dark) and 4 (Bright).

Night Time Start (Default: 18:00)

Display > Backlight Night Time Setting > Night Time Start

Set the start time for the nighttime operation to between 0:00 and 23:59.

Night Time End (Default: 6:00)

Display > Backlight Night Time Setting > Night Time End

Set the end time for the nighttime operation to between 0:00 and 23:59.

Auto Dimmer (Default: OFF)

Display > Auto Dimmer Setting > Auto Dimmer

This function sets the Auto Dimmer operation for the display backlight.

- OFF: Auto Dimmer function is turned OFF. The display backlight is turned ON continuously while the transceiver is turned ON.
- Auto-OFF: The display backlight is automatically turned ON when operating the transceiver. The backlight is automatically turned OFF after the set time of inactivity in the Auto Dimmer Timer.
- Auto-1 to Auto-3: The display backlight is automatically turned ON when operating the transceiver. The backlight automatically returns to the 1 ~ 3 set level after the Auto Dimmer Timer set time ends.

Auto Dimmer Timer (Default: 5sec)

Display > Auto Dimmer Setting > Auto Dimmer Timer

Set the backlight lighting period of time to between 5 and 10 seconds.

- 5sec: The Auto dimmer function automatically activates after 5 seconds of inactivity.
- 10sec: The Auto dimmer function automatically activates after 10 seconds of inactivity.

Auto Dimmer Cancel (PTT) (Default: OFF)

Display > Auto Dimmer Setting > Auto Dimmer Cancel (PTT)

Select the transceiver operation when [PTT] is pushed while the Auto Dimmer is activated.

- OFF: Pushing [PTT] transmits a signal without turning OFF the Auto Dimmer when the Auto Dimmer is activated.
- ON: Pushing [PTT] turns OFF the Auto Dimmer and then transmits a signal when the Auto Dimmer is activated.

Auto Dimmer Cancel (DV RX) (Default: OFF)

Display > Auto Dimmer Setting > Auto Dimmer Cancel (DV RX)

Select the transceiver operation when receiving a DV signal while the Auto Dimmer is activated.

- OFF: Receiving a DV signal displays the RX screen without turning OFF the Auto Dimmer when the Auto Dimmer is activated.
- ON: Receiving a DV signal turns OFF the Auto Dimmer and then displays the RX screen when the Auto Dimmer is activated.

Display items (Continued)

LCD Contrast (Default: 8)

Display > LCD Contrast

Set the LCD contrast level to between 1 (lowest contrast) and 16 (highest contrast).

RX Call Sign (Default: Normal)

Display > RX Call Sign

Select whether or not to display the call sign and the message of the caller station, when a call is received.

- OFF: Does not display the caller station's call sign and message.
- Normal: The caller station's call sign and message scroll only once across the display.
- RX Hold: The caller station's call sign and message scroll once, and then only the call sign is displayed until the signal disappears.
- Hold: The caller station's call sign and message scroll only once, and then only the call sign is displayed until the signal disappears. When the signal disappears, the call sign and the message are alternately displayed, each for 2 seconds.

① When this item is set to "Normal," "RX Hold" or "Hold," and if you enter the caller station's call sign and name in Your Call Sign screen, the entered name is displayed with "()" after the call sign.

RX Position Indicator (Default: ON)

Display > RX Position Indicator

Select whether or not to display  (RX position indicator) when the signal received in the DV mode contains position data.

- OFF : Displays no indicator even though the received signal contains position data.
- ON : Displays the indicator when the received signal contains position data.

① When the "RX Call Sign" is set to "OFF," the indicator is not displayed when the received signal contains position data, even if this item is set to ON.

RX Position Display (Default: ON)

Display > RX Position Display

Select whether or not to display the caller's position in a dialog when the signal received in the DV mode contains a caller station's position.

- OFF: Does not display the caller's position.
- ON: Displays the caller's position.

① You can set the display period of time in the "RX Position Display Timer" item.

RX Position Display Timer (Default: 10sec)

Display > RX Position Display Timer

Set the display period of time for the caller's position.

- 5/10/15/30sec: Displays the caller's position for this set period of time.
- Hold: Displays the caller's position until you operate the transceiver.

Reply Position Display (Default: ON)

Display > Reply Position Display

Select whether or not to display the caller's position in a dialog when the Auto Reply signal contains a caller station's position.

- OFF: Does not display the caller's position.
- ON: Displays the caller's position.

TX Call Sign (Default: Your Call Sign)

Display > TX Call Sign

Select whether or not to display your own or the destination call sign while transmitting in the DV mode.

- OFF: Does not display any call sign.
- Your Call Sign: Displays and scrolls the destination's call sign. When the destination's call sign and name are entered in your memory, the transceiver displays the name after the call sign in any DV mode except when using the DR function.
- My Call Sign: Displays and scrolls your own call sign.

Scroll Speed (Default: Fast)

Display > Scroll Speed

Set the scrolling speed of the message, call sign, or other text, that is displayed on the screen.

- Slow: The scroll speed is slow.
- Fast: The scroll speed is fast.

Display items (Continued)

Opening Message (Default: ON)

Display > Opening Message

Select whether or not to display the opening message at power ON.

- OFF: Opening message is not displayed.
- ON: Icom logo, MY call sign, the product model ("ID-4100A" or "ID-4100E")* are displayed.
*Depending on the version.

Voltage (Power ON) (Default: ON)

Display > Voltage (Power ON)

Select whether or not to display the power source voltage at power ON.

- OFF: Does not display the voltage of the external DC power source at power ON.
- ON: Displays the voltage of the external DC power source at power ON.

NOTE: When the voltage of the external DC power source is over 17.0 V, "Over Voltage" is displayed. In that case, immediately disconnect the DC power source.

Latitude/Longitude (Default: ddd °mm.mm')

Display > Display Unit > Latitude/Longitude

Select either the ddd °mm.mm' or ddd °mm'ss" format to display the position.

Altitude/Distance (Default: feet/mile*)

Display > Display Unit > Altitude/Distance

Select either the meter or feet/mile format to display the distance and altitude.

Speed (Default: mph*)

Display > Display Unit > Speed

Select either the km/h, mph or knots format to display the speed.

Temperature (Default: °F*)

Display > Display Unit > Temperature

Select either the degrees °C or °F format to display the temperature.

Barometric (Default: inHg*)

Display > Display Unit > Barometric

Select between the hPa, mb, mmHg and inHg format to display the barometric pressure.

Rainfall (Default: inch*)

Display > Display Unit > Rainfall

Select either the mm or inch format to display the amount of rainfall.

Wind Speed (Default: mph*)

Display > Display Unit > Wind Speed

Select between the m/s, mph and knots format to display the wind speed.

Display Language (Default: English)

Display > Display Language

Set the screen display language type in the DR screen or MENU screen to English or Japanese.

- ① This item is displayed only when the "System Language" is set to "Japanese." See page 9-65 "Choose your language carefully" about setting cautions.

System Language (Default: English)

Display > System Language

Set the system language of the transceiver.

- English: The system language of the transceiver is English.
Only alphabetical characters (A to Z, a to z, 0 to 9) and symbols (! " # \$ % & ' () * + , - . / : ; < = > ? @ [\] ^ _ ` { | } ~) can be displayed. If Japanese characters (Kanji, Hiragana and Katakana) are included, the display shows "=" or "_" instead of that character. In that case, you can only delete "=" or "_" in the transceiver's edit mode.
- Japanese: The system language of the transceiver is Japanese.
Kanji, Hiragana and Katakana characters, and the 2-bytes symbols can be displayed. To display such characters in the DR screen or Menu mode, set "Display Language" to "Japanese."

- ① When this item is set to "English," "Display Language" is not displayed.

*The default value may differ, depending on the transceiver version.

Display items (Continued)

Choose your language carefully

When the system language of the transceiver is set to Japanese, the transceiver has the capability to display both English and Japanese characters. HOWEVER, if you select Japanese as the display language, all menu items throughout the transceiver system will be displayed in only Japanese characters. There will be no English item names. Unless you are fluent in reading Japanese characters, use this feature with extreme caution. If you change the transceiver's language to Japanese, and cannot understand the menu system in the new setting, you will have to change the language back to English in "Display Language" or "System Language," or by doing a partial reset of the transceiver CPU. A partial reset will not clear your call sign databases.

To do a partial reset of the CPU, do the following steps:

1. Push [MENU].
2. Rotate [DIAL] to select the 8th page, then push [↵].

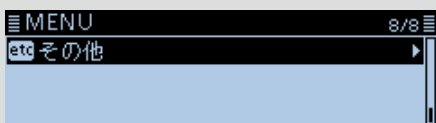

3. Select the bottom item, then push [↵].

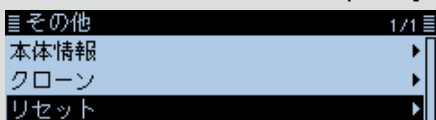

4. Select the upper item, then push [↵].

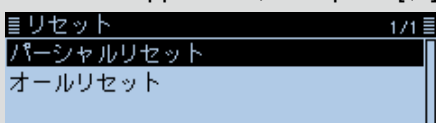

① Do not select the lower item. The lower item is for the All reset function, and the All reset clears all entries and returns all settings to their factory defaults.

5. The dialog is displayed. Select the left option, then push [↵].

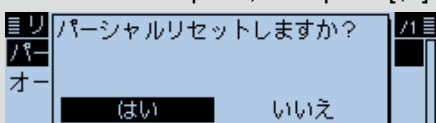

- When the partial reset is completed, "PARTIAL RESET" is displayed, then the display automatically returns to the default screen.

Sounds items

Beep Level (Default: 9)

Sounds > Beep Level

Set the beep audio output level to between 0 (OFF), 1 (minimum) and 9 (maximum).

Key-Touch Beep (Default: ON)

Sounds > Key-Touch Beep

Turn the confirmation beep tones ON or OFF.

- OFF: No beep sounds.
- ON: A beep sounds when you push a key.

Home CH Beep (Default: ON)

Sounds > Home CH Beep

Turn the Home CH Beep ON or OFF.

- OFF: No beep sounds.
- ON: Sounds a beep when you select the Home CH by rotating [DIAL].

① You can set a Home CH for the VFO mode, Memory mode and the DR function. (p. 10-7)

Band Edge Beep (Default: OFF)

Sounds > Band Edge Beep

Turn the Band edge beep ON or OFF.

- OFF: No beep sounds.
- ON: A beep sounds when you tune into or out of the AIR, 144 MHz, 230 MHz, 300 MHz, or 430 MHz band's frequency range by rotating [DIAL].

Scan Stop Beep (Default: OFF)

Sounds > Scan Stop Beep

Turn the scan stop beep ON or OFF.

- OFF: No beep sounds.
- ON: A beep sounds when a scan stops by receiving a signal.

Standby Beep

(Default: ON (to me:Alarm/High Tone))

Sounds > Standby Beep

Turn the Standby Beep function ON or OFF.

This function sounds a beep after a received signal disappears, in the DV mode.

- OFF: Does not sound a beep after a received signal disappears.
- ON: Sounds a beep after a received signal disappears.
- ON (to me: High Tone):
Sounds a high pitched beep when a received signal that is addressed to your call sign (MY) disappears.
When any other received signal disappears, a regular beep sounds.
- ON (to me: Alarm/High Tone):
Sounds alarm (PiRoPiRoPiRo) when a received signal that is addressed to your call sign (MY) disappears.
- If you release [PTT] and/or a signal is received within 5 seconds, the alarm sound changes to a high pitch beep sound when the received signal disappears.
- If no signal is received for 5 seconds after you release PTT, the next signal addressed to your call sign will again sound the alarm sound.
When any other received signal disappears, a regular beep sounds.

- ① The standby beep sounds even when "Key-Touch Beep" is set to "OFF."
- ① The standby beep output level is depending on the Beep level setting.

Scope AF Output

(Default: ON)

Sounds > Scope AF Output

Select the audio output option during a sweep by the Band Scope function.

- OFF: No audio is heard during the sweep.
- ON: Audio is heard during the sweep.

Time Set items

DATE

Time Set > Date/Time > **DATE**

Manually set the date to between 2000/01/01 and 2099/12/31.

TIME

Time Set > Date/Time > **TIME**

Manually set the time that is displayed at the top of the screen to between 0:00 and 23:59. The time is displayed in the 24 hour format.

- ① When “GPS Time Correct” is set to “Auto,” the GPS receiver automatically sets the time by calculating the received Universal Time of Coordinated (UTC) time and the “UTC Offset” setting. (p. 9-67)

GPS Time Correct (Default: Auto)

Time Set > **GPS Time Correct**

This function corrects the time by using the time information that a GPS sentence contains. It is corrected by calculating the received UTC time and the “UTC Offset” setting.

- OFF: Does not correct the time.
- Auto: Automatically corrects the time.

UTC Offset (Default: ±0:00)

Time Set > **UTC Offset**

Set the time difference between UTC time and the local time to between -14:00 and +14:00 in 00:05 steps.

Auto Power OFF (Default: OFF)

Time Set > **Auto Power OFF**

Select whether or not to automatically turn OFF the transceiver after inactivity for this set period of time.

- OFF: Does not turn OFF the transceiver.
- 30/60/90/120min: Turns OFF the transceiver after inactivity for this set period of time.

- ① “AUTO POWER OFF” is displayed and beeps sound 5 seconds before turning OFF the transceiver. If you operate the transceiver during this period of time, the Auto Power OFF timer is reset.

DV Gateway items

Enters the Terminal mode or Access Point mode. See “About the DV Gateway function” for details.

- ① “About the DV Gateway function” can be downloaded from the Icom website.

<<Terminal Mode>>

DV Gateway > <<Terminal Mode>>

The Terminal mode enables you to make a direct Gateway call through the Internet using the optional OPC-2350LU and a Windows PC or Android device. In the Terminal mode, “<<Normal Mode>>” is displayed on the DV GATEWAY screen. To cancel the Terminal mode, push [↵].

- ① You can cancel the Terminal mode in the Quick Menu window.

<<Access Point Mode>>

DV Gateway > <<Access Point Mode>>

The Access Point mode enables the D-STAR transceiver to make a Gateway call through an ID-4100A/E using the optional OPC-2350LU to a Windows PC or Android device. In the Access Point mode, “<<Normal Mode>>” is displayed in the DV GATEWAY screen. To cancel the Access Point mode, push [↵].

- ① You can cancel the Access Point mode in the Quick Menu window.

SD Card items

Load Setting

SD Card > Load Setting

Select from the list when you load the setting file.

Save Setting

SD Card > Save Setting

Save the setting file.

Import

SD Card > Import/Export > Import

Import the UR call sign, repeater list or GPS memory data in the CSV format file.

Export

SD Card > Import/Export > Export

Export the UR call sign, repeater list or GPS memory data in the CSV format file.

Separator/Decimal (Default: Sep [,] Dec [.]*)

SD Card > Import/Export > CSV Format > Separator/Decimal

Select the separator and the decimal character for the CSV format.

- Sep [,] Dec [.]: Separator is “,” and Decimal is “.”
- Sep [;] Dec [.]: Separator is “;” and Decimal is “.”
- Sep [;] Dec [,]: Separator is “;” and Decimal is “,”

*The default value may differ, depending on the transceiver version.

Date (Default: mm/dd/yyyy*)

SD Card > Import/Export > CSV Format > Date

Select the date format between “yyyy/mm/dd,” “mm/dd/yyyy” and “dd/mm/yyyy.” (y: year, m: month, d: day)

*The default value may differ, depending on the transceiver version.

SD Card Info

SD Card > SD Card Info

Displays the microSD card’s free space and its remaining recording time.

Firmware Update

SD Card > Firmware Update

Displays the Firmware Update mode.

① See “Updating the firmware” (p. 13-3) for details.

Format

SD Card > Format

Formats the microSD card, deleting all data.

Unmount

SD Card > Unmount

Electrically unmounts the microSD card while the transceiver is ON.

Bluetooth® Set items

The optional UT-137 Bluetooth UNIT is required.

Bluetooth (Default: OFF)

Bluetooth Set > Bluetooth

Turns the Bluetooth function ON or OFF.

① To use the Bluetooth function, the optional UT-137 Bluetooth UNIT is required.

- OFF: Turns OFF the function.
- ON: Turns ON the function.

Auto Connect (Default: ON)

Bluetooth Set > Auto Connect

Select whether or not to automatically connect to the paired Bluetooth device when its power is turned ON.

- OFF: Does not connect to the paired device.
- ON: Automatically connects to the last connected device.

Pairing/Connect

Bluetooth Set > Pairing/Connect

Searches for the Bluetooth device to connect, or display the paired Bluetooth devices in the list. See page 12-3 for details.

<<Pairing Reception>>

Bluetooth Set > <<Pairing Reception>>

Enters the pairing reception mode. See page 12-10 for details.

AF Output (Default: Headset Only)

Bluetooth Set > Headset Set > AF Output

Select the AF Output device when a Bluetooth headset is connected.

- Headset Only: Outputs audio to only the connected Bluetooth headset.
- Headset & Speaker: Outputs audio to both the connected Bluetooth headset and the transceiver's speaker.

Headset Function Select (Default: Normal)

Bluetooth Set > Headset Set > Headset Function Select

Select the PTT and microphone combination when both the Bluetooth headset and the transceiver microphone are used.

① To use the Bluetooth function, the optional UT-137 Bluetooth UNIT is required.

- Normal: Transmits the audio from the Bluetooth headset or the transceiver microphone whichever [PTT] is pushed.
- Microphone: Transmits the audio from the Bluetooth headset. Transmission is enabled by pushing either the [PTT] on the Bluetooth headset, or the transceiver microphone. The transceiver microphone is only used for the PTT control.
- PTT: Transmits the audio from the transceiver microphone. Transmission is enabled by pushing either the [PTT] on the Bluetooth headset, or the transceiver microphone. The Bluetooth headset is only used for the PTT control.

NOTE:

- When you select "PTT," turn OFF the VOX function.
- **DO NOT** select "PTT" when the microphone is not connected to the transceiver, and you use only the Bluetooth headset.

① The Bluetooth headset operation for each option is listed below.

Option	TX control	TX audio
Normal	Enabled	Enabled
Microphone	Enabled	Enabled
PTT	Enabled	Disabled (Audio from the microphone is transmitted.)

Bluetooth® Set items (Continued)

VOX (Default: OFF)

Bluetooth Set > Headset Set > VOX > **VOX**

The Voice Operated Transmission (VOX) function starts transmitting without pushing [PTT] when you speak into the microphone, then automatically returns to receive when you stop speaking.

① To use the VOX function, the optional VS-3 headset is required.

- OFF: Turns OFF the function.
- ON: Turns ON the function.

VOX Level (Default: 5)

Bluetooth Set > Headset Set > VOX > **VOX Level**

Set the VOX gain level to between OFF, 1 (minimum sensitivity) and 10 (maximum sensitivity).

Higher values make the VOX function more sensitive to your voice.

When "OFF" is selected, the transmission does not start when you speak into the microphone. (The VOX function is OFF.)

NOTE: Before setting the VOX gain level, it is recommended that you set the microphone gain level in "Function" of the Menu screen or the Bluetooth headset.

VOX Delay (Default: 0.5sec)

Bluetooth Set > Headset Set > VOX > **VOX Delay**

Set the VOX Delay time to 0.5, 1.0, 1.5, 2.0, 2.5 or 3.0 seconds.

The VOX Delay is the amount of time the transmitter stays ON after you stop speaking, before the VOX switches to receive.

VOX Time-Out Timer (Default: 3min)

Bluetooth Set > Headset Set > VOX > **VOX Time-Out Timer**

Set the VOX Time-Out Timer to between OFF, 1, 2, 3, 4, 5, 10, or 15 minutes to prevent an accidental prolonged transmission.

If a continuous transmission exceeds the set period of time, the transmission will be cut off.

When "OFF" is selected, the continuous transmission is not cut off.

Power Save (Default: OFF)

Bluetooth Set > Headset Set > Icom Headset > **Power Save**

Select whether or not to operate with the Power Save mode while the optional VS-3 headset is connected.

① When a headset (user supplied) or a data device is connected, the Power Save mode is automatically turned OFF, regardless of this setting.

- OFF: Turns OFF the function.
- ON: The Power Save mode is enabled when no communication or operation is performed for 120 seconds.

One-Touch PTT (Default: OFF)

Bluetooth Set > Headset Set > Icom Headset > **One-Touch PTT**

Set the One-Touch PTT function when the optional VS-3 headset is connected.

This function enables you to transmit without continuously holding down [PTT].

① When a headset (user supplied) is connected, this function is automatically turned ON, regardless of this setting.

- OFF: Transmits while holding down [PTT].
- ON: Pushing [PTT] changes transmission and reception.

PTT Beep (Default: OFF)

Bluetooth Set > Headset Set > Icom Headset > **PTT Beep**

Set the beep sound when you push [PTT] on the optional VS-3 headset.

- OFF: No beep sounds.
- ON: A beep sounds.

Custom Key Beep (Default: OFF)

Bluetooth Set > Headset Set > Icom Headset > **Custom Key Beep**

Set the beep sound when you push the Custom Key ([PLAY]/[FWD]/[RWD]) on the optional VS-3 headset.

- OFF: No beep sounds.
- ON: A beep sounds.

Bluetooth® Set items (Continued)

Custom Key

(Default: [PLAY]: ---, [FWD]: UP, [RWD]: DOWN)

Bluetooth Set > Headset Set > Icom Headset > Custom Key

Assigns the following key functions to the Custom Key ([PLAY]/[FWD]/[RWD]) on the optional VS-3 headset.

Function	Description
---	No function
UP	Push to increase the frequency, Memory channel, repeater or select the next station call sign.
DOWN	Push to decrease the frequency, Memory channel, repeater or select the previous station call sign.
VOL UP	Push to increase the volume level.
VOL DOWN	Push to decrease the volume level.
SQL UP	Push to increase the squelch level.
SQL DOWN	Push to decrease the squelch level.
Monitor	Push to open or close the squelch.
CALL	Push to select a call channel.
MR (000 CH)	In the Memory mode, push to select Memory channel 000.
MR (001 CH)	In the Memory mode, push to select Memory channel 001.
VFO/MR	Push to select between the VFO mode and the Memory mode.
DR	Push to turn the DR function ON or OFF.
FROM/TO (DR)	On the DR screen, push to select between "FROM" and "TO."
HOME CH	Push to directly select the Home CH that is set to the selected mode (VFO/Memory) or DR screen. While in the CALL CH or Weather channel mode, or when no Home CH is set, an error beep sounds.
BAND/BANK	Push to select an operating band. In the VFO mode, push to change the operating band, and in the Memory Bank mode, push to select Bank A ~ Z, or OFF. ① Only the entered bank is selectable.
SCAN	Push to start a scan. While scanning, push to stop the scan.
Temporary Skip	Push to set the frequency to be skipped during scanning. The selected frequencies are temporarily skipped for faster scanning.
RX>CS	Hold down for 1 second to set the last calling station's call sign to "TO" (destination).

Function	Description
SPEECH	Push to announce the frequency, operating mode or call sign. ① In the VFO, Memory and Call channel mode, the frequency and the operating mode are announced. ① In the DR screen, the call sign is announced. If Simplex is selected, the frequency is announced.
MODE	Push to change the operating mode.
LOW	Push to change the transmit power level.
DUP	Push to turn the Duplex mode ON or OFF, and the shift direction to DUP+ or DUP-.
PRIO	Push to turn the Priority watch ON or OFF.
TONE/DSQL	Push to select between tone types. <<MODE>> FM/FM-N TONE: Repeater Tone TSQL (⊙) : Pocket Beep with Tone Squelch TSQL: (Tone Squelch) DTCS (⊙) : Pocket Beep with DTCS Code Squelch DTCS: DTCS Code Squelch TSQL-R: Reverse Tone Squelch DTCS-R: Reverse DTCS Code Squelch DTCS (T) ("DTCS" blinks): TX:DTCS, RX:OFF TONE (T)/DTCS (R) ("T-DTCS" is displayed, "T" blinks.): TX:TONE, RX:DTCS DTCS (T)/TSQL (R) ("D-TSQL" is displayed, "D" blinks.): TX:DTCS, RX:CTCSS TONE (T)/TSQL (R) ("T-TSQL" is displayed, "T" blinks.): TX:TONE, RX:CTCSS <<MODE>> DV ① You can set this setting on the DR screen. DSQL (⊙) : Pocket Beep with Digital Call sign Squelch DSQL: Digital Call sign Squelch CSQL (⊙) : Pocket Beep with Digital Code Squelch CSQL: Digital Code Squelch
MW	In the VFO mode or on the DR screen, hold down to save the displayed frequency into a Memory blank channel.
MUTE	Push to turn the Mute function ON or OFF.

Bluetooth® Set items (Continued)

Custom Key (Continued)

Function	Description
Voice TX (T1)	<ul style="list-style-type: none"> • Push to transmit the voice audio recorded on the microSD card once. • Hold down for 1 second to repeatedly transmit the voice audio. ① This key function can also be used on the DR screen. ① If the voice audio is not saved in the [T1] (Voice memory number for TX) on the Voice TX record screen, this function is disabled.
T-CALL	Push to transmit a 1750 Hz tone.

Serialport Function

(Default: CI-V (Echo Back OFF))

Bluetooth Set > Data Device Set > **Serialport Function**

Set the serial port function for the Bluetooth SPP (Serial Port Profile) connection to a data device, PC and so on.

- CI-V (Echo Back OFF):
Transmits or receives a CI-V command.
Does not send back the serial data received from the SPP connection.
- CI-V (Echo Back ON):
Transmits or receives a CI-V command.
Sends back the serial data received from the SPP connection.
- DV Data: Transmits or receives data in the DV mode.
Does not input the cloning or weather data entries, or output the GPS data.

Bluetooth Device Information

Bluetooth Set > **Bluetooth Device Information**

Displays the Bluetooth device information.

Initialize Bluetooth Device

Bluetooth Set > **Initialize Bluetooth Device**

Initializes the installed Bluetooth unit.

Others items

Voltage

Others > Information > **Voltage**

Displays the voltage of the external power supply.

Version

Others > Information > **Version**

Displays the transceiver firmware's version number.

① When the optional UT-137 Bluetooth UNIT is installed, the unit's version number is also displayed.

Clone Mode

Others > Clone > **Clone Mode**

Select to enter the clone mode to read or write the CS-4100 data from or to the PC.

See page 10-14 for details.

Partial Reset

Others > Reset > **Partial Reset**

Select to reset the operating settings to their default values (VFO frequency, VFO settings, menu contents) without clearing the items below.

- Memory channel content
- Scan Edge content
- Call channel content
- Call sign memories
- Message content
- DTMF memory content
- GPS Memory content
- Repeater list content

See page 10-18 for details.

All Reset

Others > Reset > **All Reset**

Select to clear all content and return all settings to their factory defaults.

See page 10-18 for details.

Section 10 OTHER FUNCTIONS

See Basic manual section 7 for details of the microSD card installation details.

Selecting a Squelch delay	10-2
Transmit power levels and RF meter.....	10-2
Attenuator function	10-3
◇ Operating the Attenuator function	10-3
Microphone gain level setting	10-3
Band Scope function	10-4
◇ Sweep operation	10-4
Voice TX function.....	10-5
◇ Recording the voice audio	10-5
◇ Transmitting the recorded voice audio.....	10-6
◇ Changing the voice TX settings	10-6
Home channel function.....	10-7
◇ Home channel setting	10-7
◇ Home channel operation.....	10-7
◇ Home CH Beep function	10-7
Using the DTMF memory	10-8
◇ Entering DTMF code.....	10-8
◇ Transmitting DTMF code	10-9
◇ Transmitting DTMF code (Direct Input).....	10-9
◇ Setting the DTMF transmit speed	10-10
Tone squelch operation	10-11
◇ Tone squelch frequency setting and operation	10-11
DTCS squelch operation	10-12
◇ DTCS code setting and operation.....	10-12
◇ The DTCS code operation	10-12
Weather channel operation (USA version only).....	10-13
◇ Selecting a Weather channel	10-13
◇ Weather alert function.....	10-13
Cloning function.....	10-14
◇ Transceiver-to-Transceiver cloning using a microSD card .	10-15
◇ Cloning from a PC using a microSD card	10-17
Resetting the CPU.....	10-18
◇ Partial Reset	10-18
◇ All Reset	10-18
Remote control (CI-V) information.....	10-19
◇ CI-V connection example.....	10-19
◇ Preparing	10-19
◇ Data format	10-19
◇ Command table	10-20

Selecting a Squelch delay

You can select a squelch delay in the MENU screen to prevent repeated opening and closing of the squelch while receiving the same signal.

Function > Squelch Delay

1. Push [MENU].
2. Rotate [DIAL] to select “Function,” then push [↵].

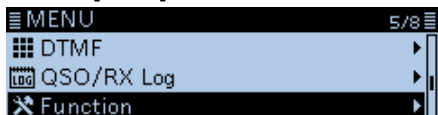

3. Select “Squelch Delay,” then push [↵].

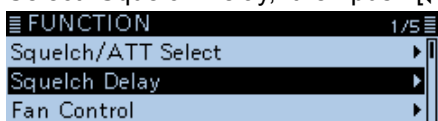

4. Select an option.
 - Short: Short squelch delay.
 - Long: Long squelch delay.



5. Push [MENU].
 - Returns to the standby screen.

Transmit power levels and RF meter

The transmit power level and the RF meter displays are shown below.

	LOW	MID	HIGH
RF meter (TX display)			
Power level (at TX)	5 W	15 W	25/50 W*

*Depending on the transceiver version.

TIP: To change the transmit power level
Push [QUICK], then select “TX Power.”

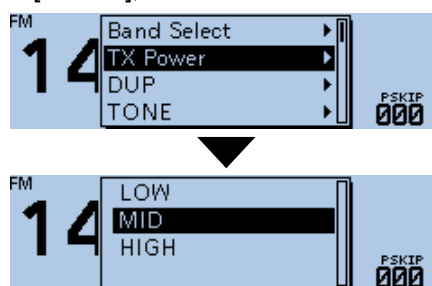

Attenuator function

The transceiver has an RF attenuator related to the squelch control setting. You can add up to approximately 20 dB of attenuation at its maximum setting.

You can set the Attenuator to [SQL] in the MENU screen.

Function > Squelch/ATT Select

1. Push [MENU].
2. Rotate [DIAL] to select "Function," then push [↵].



3. Select "Squelch/ATT Select," then push [↵].

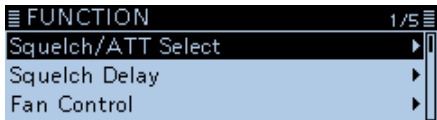

4. Select "ATT," then push [↵].

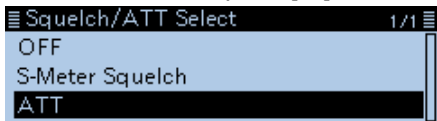

5. Push [MENU].
 - Returns to the standby screen.

◇ Operating the Attenuator function

Rotate [SQL] clockwise past the 12 o'clock position to turn ON the Attenuator and adjust the attenuation level up to approximately 20 dB.

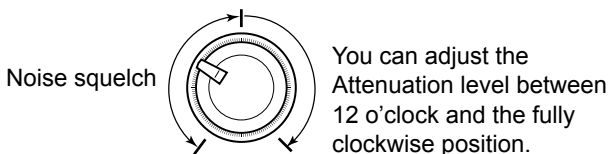

Displayed

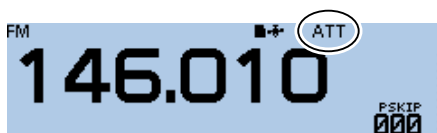

Microphone gain level setting

Set the microphone gain level in the MENU screen.

Function > MIC Gain

1. Push [MENU].
2. Rotate [DIAL] to select "Function," then push [↵].



3. Select "MIC Gain," then push [↵].

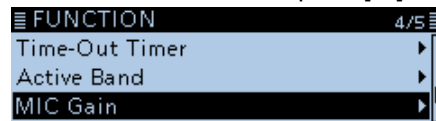

4. Rotate [DIAL] to set the microphone gain level.
 - ① Set higher values to make the microphone more sensitive to your voice.



5. Push [MENU].
 - Returns to the standby screen.

Band Scope function

Use the Band Scope function to visually search for a specified frequency range around the displayed frequency.

You can use this function to search for a signal, and see the received signal strength level.

The Band Scope function has two sweep types, Single sweep and Continuous sweep:

- A Single sweep searches the specified frequency range only once.
- A Continuous sweep repeatedly searches the specified frequency range.

The transceiver sweeps in “±25 × Tuning step” steps centered on the displayed frequency.

① ‘±25’ is fixed.

For example, if the display frequency is 146.010 MHz and its tuning step is 20 kHz, the sweep range is between 145.510 MHz (lower frequency) and 146.510 MHz (higher frequency). (146.010 MHz ±0.5 MHz)

See the calculation below.

$$+25 \times 20 \text{ kHz} = +500 \text{ kHz (0.5 MHz)}$$

$$-25 \times 20 \text{ kHz} = -500 \text{ kHz (-0.5 MHz)}$$

$$\text{Upper frequency: } 146.510 \text{ MHz} \\ (146.010 \text{ MHz} + 0.5 \text{ MHz})$$

$$\text{Lower frequency: } 145.510 \text{ MHz} \\ (146.010 \text{ MHz} - 0.5 \text{ MHz})$$

Example: A strong signal is received on 146.030 MHz. (Tuning step: 5 kHz)

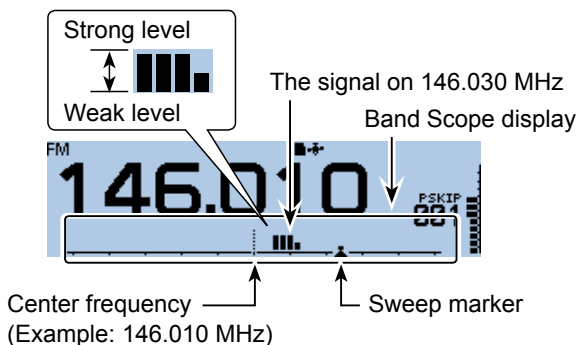

TIP:

- The specified tuning step is used during a sweep. If the tuning step is set too wide, the signals in the sweep range may not be displayed (they may be skipped), even if they are strong signals. Thus we recommend that you set the tuning step to 20 kHz or less to use the Band Scope function. See Basic manual section 3 for details.
- You can hear the displayed frequency’s audio during a sweep.
- You can turn OFF the audio output during a sweep in the MENU screen. (p. 9-66) (Sounds > **Scope AF Output**)

◇ Sweep operation

Example: Continuous sweeps centered on 146.010 MHz

1. Push [V/M] several times until you enter the VFO mode.
2. Rotate [DIAL] to set 146.010 MHz.



3. Push [QUICK].
4. Rotate [DIAL] to select “Band Scope,” then push [↵].

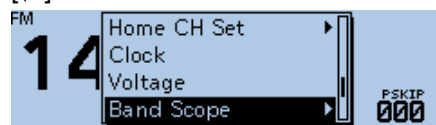

5. Select “Continuous Sweep,” then push [↵].

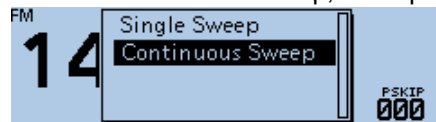

- Returns to the frequency display and starts continuous sweeping.

6. Push [↵].
7. When the sweeping stops, rotate [DIAL] to move the sweep marker to a detected signal.



① You can hear the signal audio.

8. Push [QUICK].
9. Rotate [DIAL] to select “Band Scope,” then push [↵].
10. Select “Scope OFF,” then push [↵].

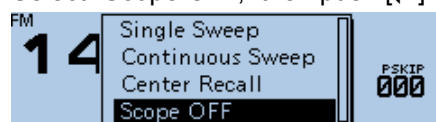

- Turns OFF the Band Scope function.

TIP: In the Band scope setting window, select “Center Recall” to set the sweep marker to the center frequency.

Voice TX function

The Voice TX function transmits the audio that is on the microSD card, one time or repeatedly, for up to 10 minutes at the specified interval.

Up to 4 memories can be used for repeatedly calling CQ or for other events.

When the key function [Voice TX (T1)] is assigned to a microphone key, push the key to transmit the saved audio in the "T1" (Voice memory number for TX). (p. 9-59)

NOTE: Be sure to insert a microSD card into the transceiver.

◇ Recording the voice audio

Voice TX > Record

1. Push [MENU].
2. Rotate [DIAL] to select "Voice TX," then push [↵].
3. Select "Record," then push [↵].
 - Displays the VOICE TX RECORD screen.
4. Select the memory number, "T1" ~ "T4."



• The "VOICE TX RECORD (T1)" screen is displayed when "T1" memory is selected.

5. Push [MW] to start recording.

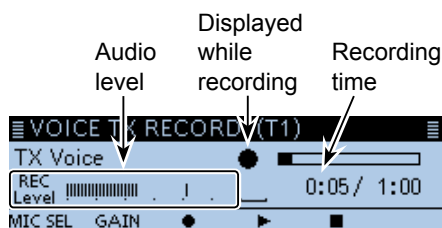

① Hold the microphone 5 to 10 cm (2 to 4 inches) from your mouth, then speak at a normal voice level.

① The maximum record time is 1 minute.

6. Push [MONI] to stop recording.
7. Push [RX→CS] to playback the recorded audio.



① If you push [MW], the recording starts again. In this case, the previous recorded audio will be overwritten.

① Push [MODE] to display the microphone gain setting screen. Rotate [DIAL] to set the gain level.

8. Push [↵].
 - Returns to the VOICE TX RECORD screen.



TIP: On the VOICE TX RECORD screen, push [QUICK], then select "Clear" to clear the recorded audio.

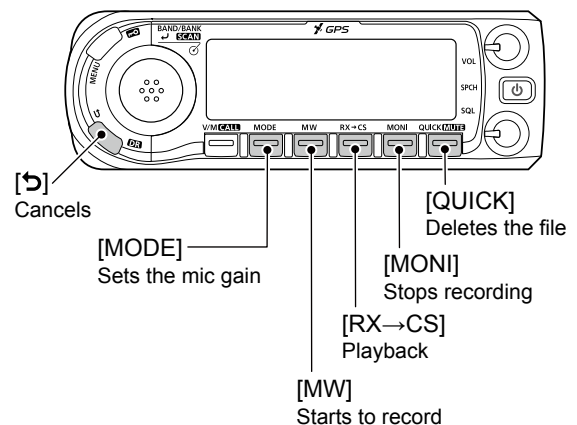

Voice TX function (Continued)

◇ **Transmitting the recorded voice audio**

NOTE: Be sure to insert a microSD card into the transceiver.

Voice TX > <<TX>>

1. Push [MENU].
2. Rotate [DIAL] to select “Voice TX,” then push [↵].
3. Select “<<TX>>,” then push [↵].
4. Select the memory number, “T1” ~ “T4,” then push [↵].

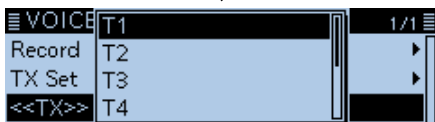

- The recorded voice audio is transmitted once.

① **Information**

- While transmitting, the SD card icon blinks.
- When you select “T1 (Repeat TX)” ~ “T4 (Repeat TX)” in step 4, the transceiver repeatedly transmits the recorded voice audio for up to 10 minutes at the interval specified in “Repeat Time.”
- Push [PTT] to cancel a recorded voice transmission.

TIP: To send the recorded voice audio in the Quick Menu window, push [QUICK], then select “Voice TX.”



◇ **Changing the voice TX settings**

You can change the voice TX settings on the MENU screen. (p. 9-23)

Setting the Repeat Time

Set the repeat interval for the voice repeat transmission.

The transceiver repeatedly transmits the recorded voice audio at 5 second intervals as the default.

Voice TX > TX Set > Repeat Time

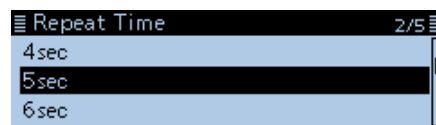

Using the TX Monitor function

The TX voice audio is output from the speaker as the default. (Default: ON)

Voice TX > TX Set > TX Monitor



Home channel function

Home channels are often-used frequencies you can preset in the transceiver’s VFO mode, Memory mode and DR function. Select the Home channel by just pushing [HOME] in each mode.

◇ Home channel setting

1. Select a mode (VFO or Memory) or the DR screen in which you want to set the Home channel.
2. Select a frequency to be set as the Home channel.
 - ① On the DR screen, select “FROM.”
3. Push [QUICK].
4. Rotate [DIAL] to select “Home CH Set,” then push [↵].

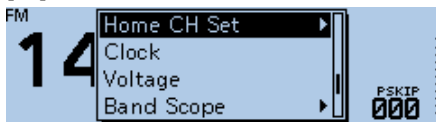

5. Select an option, then push [↵].

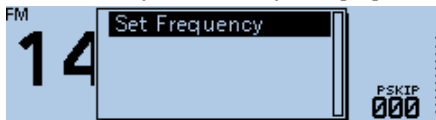

- ① In the VFO mode, select “Set Frequency,” in the Memory mode, select “Set Channel.” or on the DR screen, select “Set Repeater.”

TIP: Selecting “Clear” in step 4 clears the Home channel setting.

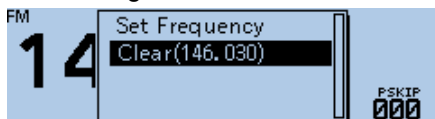

◇ Home channel operation

1. Select a mode (VFO or Memory) or the DR screen in which you want to select the Home channel.



2. Push [HOME] on the microphone.

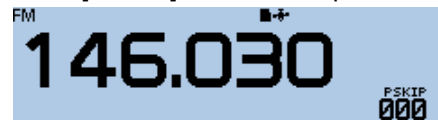

- Selects the Home channel of the selected mode or DR screen.

◇ Home CH Beep function

When the specified Home CH is selected by rotating [DIAL], a beep sounds. You will know the Home CH selection without looking at the display.

- ① You can turn OFF the Home CH Beep function on the MENU screen.
(Sounds > Home CH Beep)

Using the DTMF memory

The transceiver can save up to 16 memories of 24-digit DTMF code.

◇ Entering DTMF code

DTMF > DTMF Memory

1. Push [MENU].
2. Rotate [DIAL] to select “DTMF,” then push [↵].

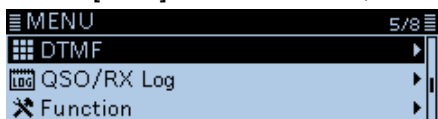

3. Select “DTMF Memory,” then push [↵].



- Displays the DTMF memory list (d0 to d#).

4. Select the DTMF memory, then push [↵].
(Example: d0)

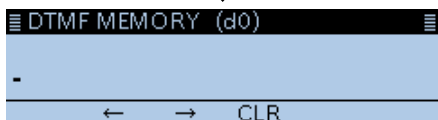

5. Enter the DTMF code, then push [↵].
(Example: 12345A)

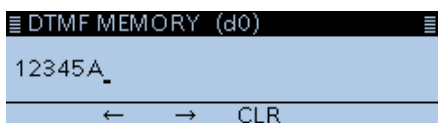

- Saves the channel, and returns to the DTMF MEMORY screen.

① See “Entering and editing text” for details. (p. iv)

6. Push [MENU].
• Returns to the standby screen.

TIP: To clear the entered DTMF code, push [QUICK] on the DTMF MEMORY screen, then select “Clear.”

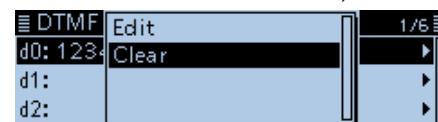

Using the DTMF memory (Continued)

◇ **Transmitting DTMF code**

1. Push [QUICK].
2. Rotate [DIAL] to select “DTMF TX,” then push [↵].

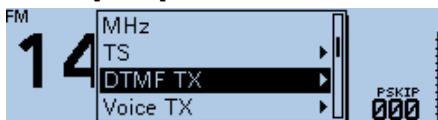

3. Select the DTMF memory channel to transmit, then push [↵].

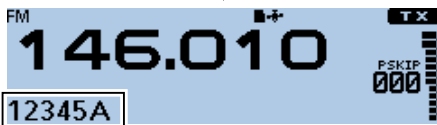
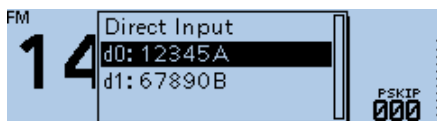

- Transmits the selected DTMF code.
- ① The DTMF code scrolls during transmission.

◇ **Transmitting DTMF code (Direct Input)**

1. Push [QUICK].
2. Rotate [DIAL] to select “DTMF TX,” then push [↵].
3. Select “Direct Input.”

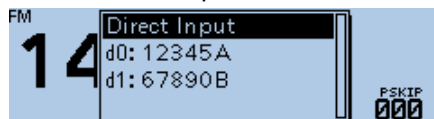

4. Enter the DTMF code, then push [↵].
(Example: 123A)

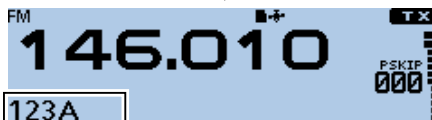
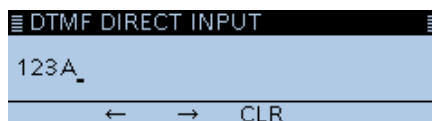

- Transmits the entered DTMF code.
- ① The DTMF code scrolls during transmission.
- ① See “Entering and editing text” for details. (p. iv)

Using the DTMF memory (Continued)

◇ **Selecting the DTMF transmit speed**

You can select the DTMF transmit speed.

DTMF > DTMF Speed

1. Push [MENU].
2. Rotate [DIAL] to select “DTMF,” then push [↵].

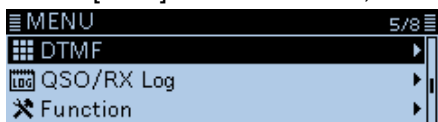

3. Select “DTMF Speed,” then push [↵].

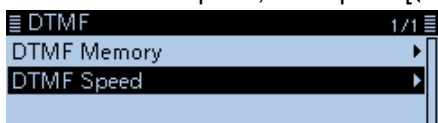

4. Select a transmit speed.
 - 100ms: Transmits the DTMF tones at about 100 milliseconds per code. 5 characters per second.
 - 200ms: Transmits the DTMF tones at about 200 milliseconds per code. 2.5 characters per second.
 - 300ms: Transmits the DTMF tones at about 300 milliseconds per code. 1.6 characters per second.
 - 500ms: Transmits the DTMF tones at about 500 milliseconds per code. 1 character per second.



5. Push [MENU].
 - Returns to the standby screen.

Image of the DTMF transmit speed

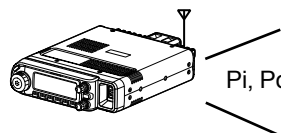

When “100ms” is set, the DTMF transmit speed is fast.

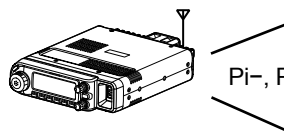

When “500ms” is set, the DTMF transmit speed is slow.

Tone squelch operation

The tone squelch opens only when you receive a signal containing a matching subaudible tone in the FM or FM narrow mode. You can silently wait for calls from others using the same tone.

Also, the reversed tone squelch function will mute the squelch when a signal containing a matched subaudible tone.

◇ Tone squelch frequency setting and operation

Step 1. Setting the tone squelch frequency

DUP/TONE... > TSQL Freq

1. Push [V/M] several times until you enter the VFO mode.
2. Push [MODE] several times until you select the FM or FM-N (FM narrow) mode.
3. Rotate [DIAL] to set an operating frequency.

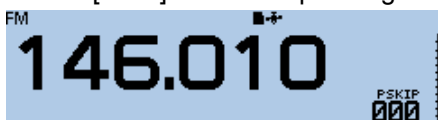

4. Push [MENU].
5. Rotate [DIAL] to select "DUP/TONE...", then push [↵].
6. Select "TSQL Freq," then push [↵].
7. Rotate [DIAL] to set a tone squelch frequency, then push [↵].



① Set to between 67.0 and 254.1 Hz.

8. Push [MENU].
 - Returns to the standby screen.

Step 2. Using the tone squelch

1. Push [QUICK].
2. Select "TONE," then push [↵].
3. Select the tone squelch type. (Example: TSQL)

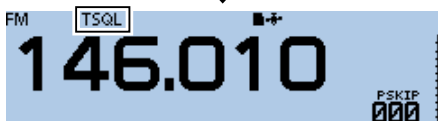
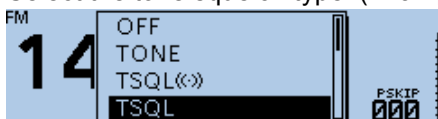

4. Holding down [PTT] and call a station. Operate normally.

About the tone squelch type:

- TSQL ((·)): Enables the Tone Squelch with the Pocket Beep function.
- TSQL: Enables the Tone Squelch function.
- TSQL-R: Enables the Reverse Tone Squelch function.
- TONE(T)/DTCS(R)
 - ("T-DTCS" is displayed, "T" blinks.): When you transmit, the selected subaudible tone is superimposed on your normal signal. When you receive, the DTCS squelch opens only for a signal that includes a matching DTCS code and polarity. (Audio is heard)
- DTCS(T)/TSQL(R)
 - ("D-TSQL" is displayed, "D" blinks.): When you transmit, the selected DTCS code is superimposed on your normal signal. When you receive, the tone squelch opens only for a signal that includes a matching tone frequency. (Audio is heard)
- TONE(T)/TSQL(R)
 - ("T-TSQL" is displayed, "T" blinks.): When you transmit, the selected subaudible tone is superimposed on your normal signal. When you receive, the tone squelch opens only for a signal that includes a matching tone frequency. (Audio is heard)

To sound beeps when a call is received.

If "TSQL ((·))" is selected, beeps sound for 30 seconds and "((·))" blinks when a call with the matched tone signal is received.



- ① Within 30 seconds, push [PTT] to stop the beeps. ("((·))" disappears) After that, the transceiver selects the regular tone squelch operation. If you make no operation for 30 seconds, the beeps automatically stop, but "((·))" continues to blink to indicate that you received a call.

DTCS squelch operation

The tone squelch opens only when you receive a signal containing a matching DTCS code in the FM or FM narrow mode. You can silently wait for calls from others using the same tone. Also, a reversed tone squelch function will mute the squelch when you receive a signal containing a matched DTCS code.

◇ DTCS code setting and operation

Step 1. Setting the DTCS code

DUP/TONE... > DTCS Code

1. Push [V/M] several times until you enter the VFO mode.
2. Push [MODE] several times until you select the FM or FM-N (FM narrow) mode.
3. Rotate [DIAL] to set an operating frequency.

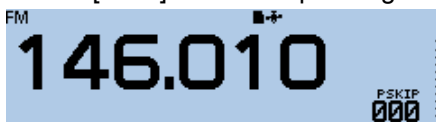

4. Push [MENU].
5. Rotate [DIAL] to select "DUP/TONE...", then push [↵].
6. Select "DTCS Code," then push [↵].
7. Rotate [DIAL] to set a DTCS code, then push [↵].



① Set to between 023 and 754.

8. Push [MENU].
 - Returns to the standby screen.

◇ The DTCS code operation

1. Push [QUICK].
2. Select "TONE," then push [↵].
3. Select the DTCS code type. (Example: DTCS)

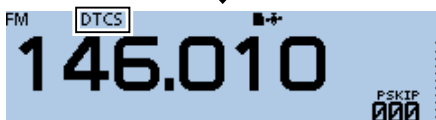
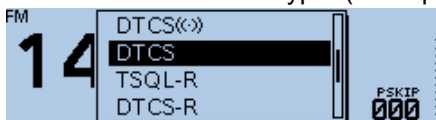

4. Holding down [PTT] and call a station. Operate normally.

About the DTCS code type:

- DTCS ((·)) : Enables the DTCS squelch with the Pocket Beep function.
- DTCS: Enables the DTCS Squelch function.
- DTCS-R: Enables the Reverse DTCS Squelch function.
- DTCS(T) ("DTCS" blinks):
When you transmit, the selected DTCS code is superimposed on your normal signal. When you receive, the function is OFF.
- TONE(T)/DTCS(R)
("T-DTCS" is displayed, "T" blinks.):
When you transmit, the selected subaudible tone is superimposed on your normal signal. When you receive, the DTCS squelch opens only for a signal that includes a matching DTCS code and polarity. (Audio is heard)
- DTCS(T)/TSQ(L)(R)
("D-TSQL" is displayed, "D" blinks.):
When you transmit, the selected DTCS code is superimposed on your normal signal. When you receive, the tone squelch opens only for a signal that includes a matching tone frequency. (Audio is heard)

To sound beeps when a call is received.

If "DTCS ((·))" is selected, beeps sound for 30 seconds and "((·))" blinks when a call with the matching tone signal is received.



- ① Within 30 seconds, push [PTT] to stop the beeps. ("((·)") disappears) After that, the transceiver selects the regular tone squelch operation. If you make no operation for 30 seconds, the beeps automatically stop, but "((·)") continues to blink to indicate that you received a call.

Weather channel operation (USA version only)

There are 10 weather channels for monitoring the National Oceanographic and Atmospheric Administration (NOAA) weather broadcasts.

◇ Selecting a Weather channel

1. Push [QUICK].
2. Rotate [DIAL] to select "Weather CH," then push [↵].

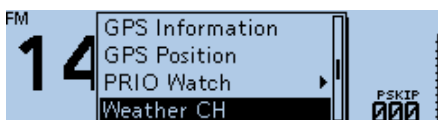

- Enters the Weather channel mode.

3. Rotate [DIAL] to select a weather channel.

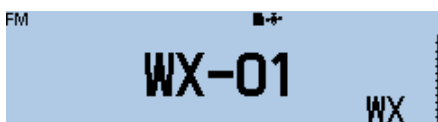

- Displays the selected weather channel number ("WX-01" ~ "WX-10").

TIP: To return to the previous frequency or Memory channel, push [QUICK], then select "Weather CH OFF."

◇ Weather alert function

NOAA broadcast stations transmit weather alert tones before important weather announcements.

When the weather alert function is turned ON, the selected weather channel is monitored every 5 seconds for an announcement.

When an alert signal is detected, the "ALT" and the WX channel are alternately displayed, and a beep sounds until you change the operating mode or weather channel, turn OFF the Weather Alert function, or turn OFF the transceiver.

The previously selected (used) weather channel is checked periodically during standby, or while scanning.

1. Push [QUICK].
2. Rotate [DIAL] to select "Weather Alert," then push [↵].

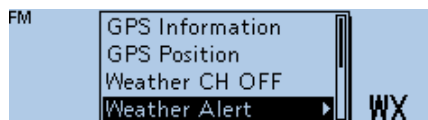

3. Select "ON."

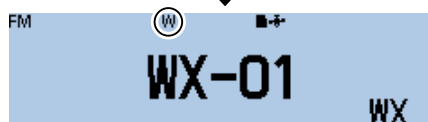
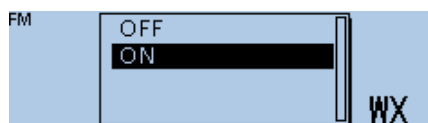

- Turns ON the Weather Alert function, and "W" is displayed.

Cloning function

The ID-4100A/E has a data cloning capability. This function is useful when you want to copy all of the entered contents from one ID-4100A/E to another. Cloning can also be done with a PC.

Transceiver-to-Transceiver cloning using a microSD card (p. 10-15)

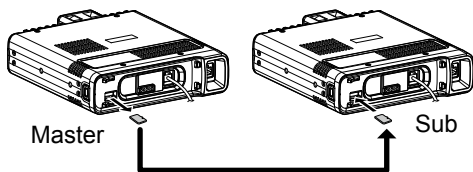

Cloning from a PC using a microSD card (p. 10-17, CS-4100 Instruction manual)

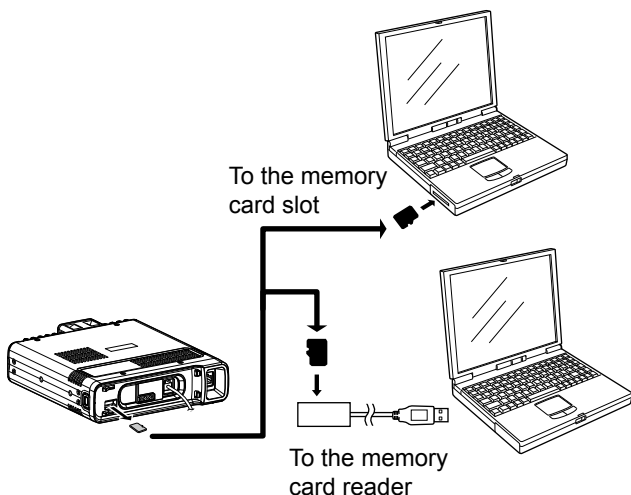

- ① If your PC does not have a microSD card slot, connect a memory card reader (user supplied) to use the microSD card.

Cloning from a PC using an optional cloning cable (CS-4100 Instruction manual)

By using the CS-4100 CLONING SOFTWARE and an optional cloning cable, cloning can be done with a PC. See the CS-4100 instruction manual that can be downloaded from the Icom website.
<http://www.icom.co.jp/world/support/>

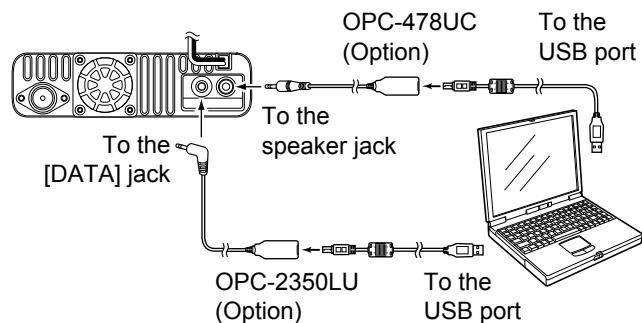

IMPORTANT: When using the OPC-2350LU, set the “DV Data TX” setting of the transceiver to “PTT,” before reading or writing setting data. Otherwise, when a PC input data through the [DATA] jack, the transceiver automatically transmits it.
 (MENU > DV Set > DV Data TX)

Cloning function (Continued)

◆ Transceiver-to-Transceiver cloning using a microSD card

This section describes the cloning method using a microSD card. Memory channel contents, MENU item settings and repeater lists can be saved onto the microSD card.

- ① Recorded voice memories are not included in the cloning data. To play back the master transceiver's voice memory, insert the microSD card into a sub transceiver, or make a copy onto the sub transceiver's microSD card using a PC.
- ① Assumes that the microSD card has already been inserted into the transceiver.

Step 1. Saving the master transceiver's setting data onto the microSD card.

SD Card > Save Setting

1. Push [MENU].
2. Rotate [DIAL] to select "SD Card," then push [↵].
3. Select "Save Setting," then push [↵].
4. Select "<<New File>>," then push [↵].

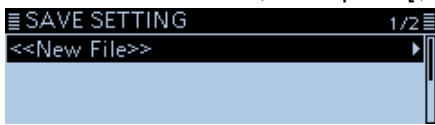

- Displays the FILE NAME screen.
- ① The file name is automatically named in the following manner: Setyyymmdd_xx (yyyy: Year, mm: month, dd: day, xx: serial number)
Example: If a second file is saved on April 1, 2017, the file is named "Set20170401_02."

- ① To change the file name, see "Save with a different file name." (p. 6-4)
5. Push [↵].

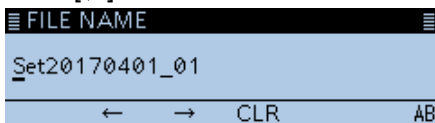

- The confirmation dialog "Save file?" is displayed.

6. Select <YES>, then push [↵].



- Saves the data settings.
- ① While saving, a progress bar is displayed, then returns to the SD CARD screen after the saving is completed.

7. Push [MENU].
- Returns to the standby screen.

Step 2. Remove the microSD card from the master transceiver, then insert it into the sub transceiver.

1. Hold down the master transceiver's [⏻] to turn OFF the power.
2. Remove the microSD card from the master transceiver.
3. Insert the microSD card into the sub transceiver, then hold down the sub transceiver's [⏻] to turn ON the power.

NOTE: Before inserting, be sure to check the card direction. If the card is forcibly or inversely inserted, it will damage the card and/or the slot.

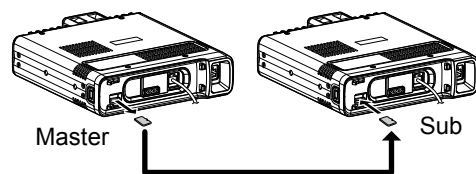

TIP: The setting data are saved in the "icf" file format that is used in the CS-4100 CLONING SOFTWARE. When the saved data on a card is copied to a PC, you can edit it with the cloning software.

Cloning function

◇ Transceiver-to-Transceiver cloning using a microSD card (Continued)

Step 3. Loading the setting data into the sub transceiver.

SD Card > Load Setting

1. Push [MENU].
2. Rotate [DIAL] to select "SD Card," then push [↵].
3. Select "Load Setting," then push [↵].
4. Select a file to load.

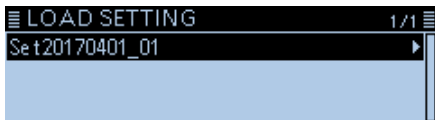

- Displays the LOAD SETTING screen.
5. Select the loading option, then push [↵].
 - ALL: Loads all memory channels, Menu screen item settings and the repeater list into the transceiver.
 - Except My Station: Loads all memory channels, Menu screen item settings and the repeater list except MY call signs and TX message into the transceiver.
 - Repeater List Only: Loads only the repeater list into the transceiver.

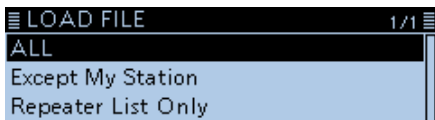

- The confirmation dialog "Keep 'SKIP' settings in the Repeater List?" is displayed.
6. Select <YES>, <NO> or <Cancel>, then push [↵].
 - YES: Retains the skip settings of the repeater list. (p. 4-40)
 - NO: Does not retain the skip settings of the repeater list.
 - Cancel: Returns to the LOAD FILE screen.

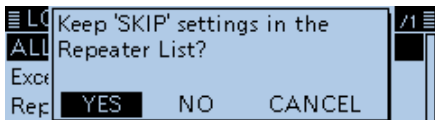

- When you select <YES> or <NO>, the confirmation dialog "Load file?" is displayed.

7. Select <YES>, then push [↵].

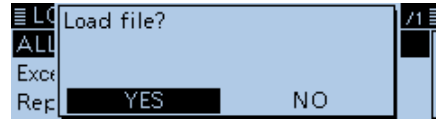

- Starts the file check.
- ① While checking the file, displays "CHECKING FILE" and a progress bar.

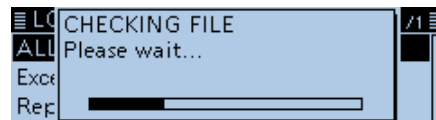

8. After checking, settings data loading begins.
 - ① While loading, "LOADING" and a progress bar are displayed.

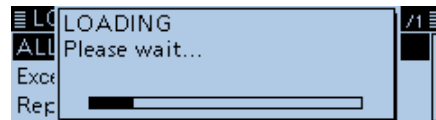

9. After loading ends, "COMPLETED!" is displayed.
 - ① To complete the loading, restart the transceiver.

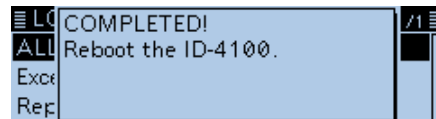

Cloning function (Continued)

◇ Cloning from a PC using a microSD card

You can clone transceivers from a PC using a microSD card. Set memory content, Menu item settings and repeater list in the CS-4100 CLONING SOFTWARE, and save them in an “icf” file format. Copy the “icf” file to the “Setting” folder in the “ID-4100” folder of the microSD card.

microSD card configuration

Insert the microSD card that includes the “icf” file, then load it to complete the cloning.

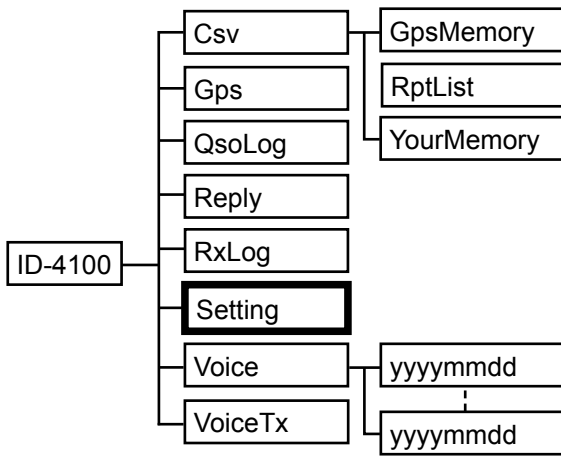

Connections

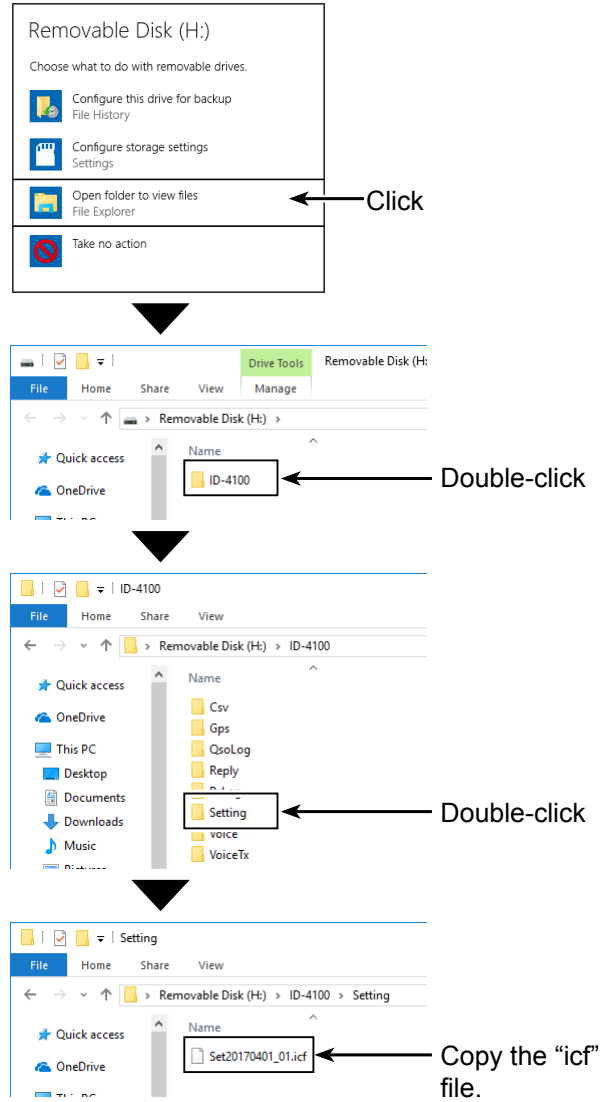
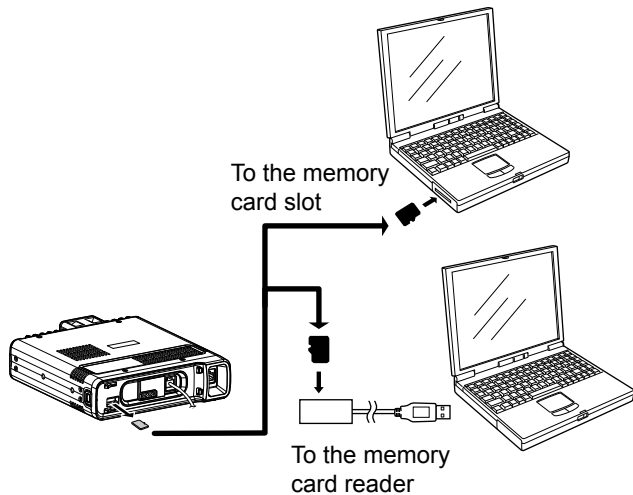

Resetting the CPU

Occasionally, erroneous information will be displayed when, for example, first applying power. This may be caused externally by static electricity or by other factors. If this problem occurs, turn OFF the transceiver. After waiting a few seconds, turn ON the transceiver again. If the problem is still there, perform a Partial reset or an All reset.

NOTE for the All reset:

After you perform an All reset, you cannot use the DR function because the repeater list will be cleared. So we recommend you save the setting data onto a microSD card, or to your PC using the CS-4100 cloning software before performing an All reset. After the All reset is finished, load or write the saved data into your transceiver.

◇ Partial Reset

Others > Reset > **Partial Reset**

1. Push [MENU].
2. Rotate [DIAL] to select "Others," then push [↵].



3. Select "Reset," then push [↵].



4. Select "Partial Reset," then push [↵].



• The confirmation dialog "Partial Reset?" is displayed.

5. Select <YES>, then push [↵].

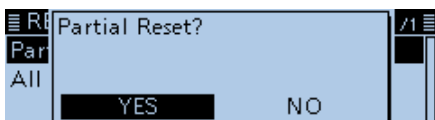

• When the partial reset is completed, "PARTIAL RESET" is displayed, then the display automatically returns to the default screen.

① A Partial reset resets the operating settings to their default values (VFO frequency, VFO settings, menu contents) without clearing the items below:

- Memory channel contents
- Scan Edge contents
- Call channel contents
- Call sign memories
- Message data
- DTMF memory contents
- GPS Memory contents
- Repeater list

◇ All Reset

Others > Reset > **All Reset**

1. Push [MENU].
2. Rotate [DIAL] to select "Others," then push [↵].
3. Select "Reset," then push [↵].
4. Select "All Reset," then push [↵].



• The confirmation dialog "All Reset?" is displayed.

5. Select <NEXT>, then push [↵].

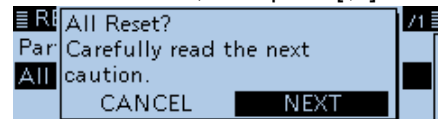

• The confirmation dialog as shown below is displayed.

6. Select <YES>, then push [↵].

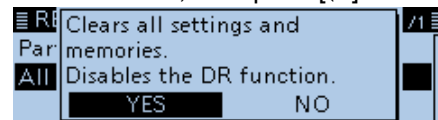

• After the All reset is finished, the default screen is displayed.

① An All reset clears all setting, and returns all settings to their factory defaults. Therefore, the repeater list, Memory channel contents, filter settings and so on will be cleared, so you will need to reenter your memories, list and operating settings.

Remote control (CI-V) information

◇ CI-V connection example

The transceiver's operating frequency, mode, VFO and memory selection, can be remotely controlled using a PC.

The Icom Communications Interface V (CI-V) is used for remote control.

◇ Preparing

To control the transceiver, first set its address, data communication speed, and transceive function. These settings are set on the MENU screen. (p. 9-60) (Function > **CI-V**)

- ① When the OPC-478UC is connected, the received audio cannot be heard. To hear the received audio, use the cable as shown to the right.

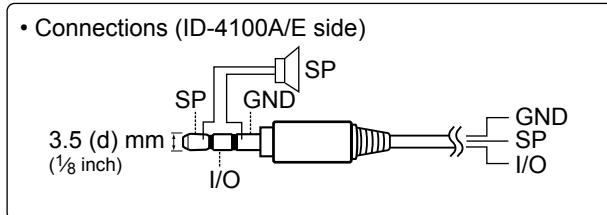
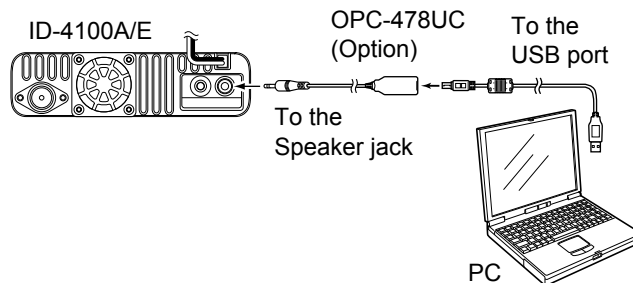

◇ Data format

The CI-V system can be written using the following data formats. Data formats differ according to command numbers. A data area or sub command is added for some commands.

Controller to ID-4100A/E

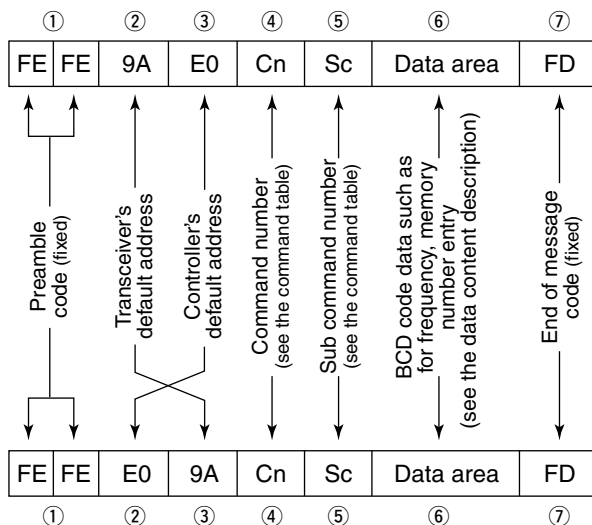

ID-4100A/E to controller

OK message to controller

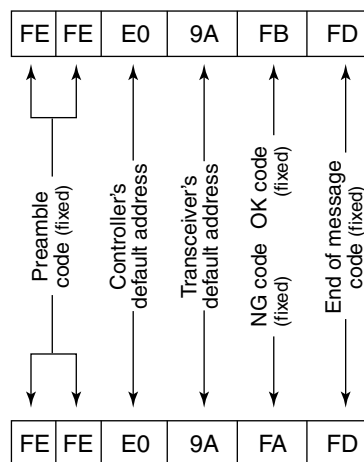

NG message to controller

Remote jack (CI-V) information (Continued)

◆ Command table

Cmd.	Sub cmd.	Data	Description
00		see p. 10-21	Send operating frequency for transceiver
01		see p. 10-21	Send operating mode for transceiver
03		see p. 10-21	Read operating frequency
04		see p. 10-21	Read operating mode
05		see p. 10-21	Send operating frequency
06		see p. 10-21	Send operating mode
07			Select VFO mode
0C		see p. 10-21	Read frequency offset*1
0D		see p. 10-21	Send frequency offset
0F			Read duplex setting (10=simplex, 11=DUP-, 12=DUP+)
	10		Set simplex operation
	11		Set DUP- operation
	12		Set DUP+ operation
14	01	0000 to 0255	Send/read audio output level (000=Minimum, 0128=Center, 0255=Maximum)
	03	0000 to 0255	Send/read squelch level (000=Minimum, 0128=Center, 0255=Maximum)
	0A	see p. 10-21	Send/read RF power setting
	0B	see p. 10-21	Send/read external microphone gain.
	16	see p. 10-22	Send/read VOX gain.
15	01	00	Read noise/S-meter squelch status (squelch close)
		01	Read noise/S-meter squelch status (squelch open)
	02	0000 to 0255	Read S-meter level (0000=S0, 0170=S9)
	05	00	Read tone squelch and RF squelch status (squelch close)
		01	Read tone squelch and RF squelch status (squelch open)
	11	0000 to 0255	Read RF power meter (0026=LOW, 0077=MID, 0255=HIGH)
16	42	00	Send/read Repeater tone OFF
		01	Send/read Repeater tone ON
	43	00	Send/read Tone squelch OFF
		01	Send/read Tone squelch ON
		02	Send/read Reversed Tone squelch ON
	46	00	Send/read VOX function OFF
		01	Send/read VOX function ON
	4B	00	Send/read DTCS OFF
		01	Send/read DTCS ON
		02	Send/read Reversed DTCS ON
	5B	00	Send/read DSQL/CSQL OFF (DV mode only)
		01	Send/read DSQL ON (DV mode only)
		02	Send/read CSQL ON (DV mode only)
	5C	00, 01, 02	Send/read GPS TX mode (00=OFF, 01=D-PRS, 02=NMEA)
	5D	00 to 09	Tone setting 00=OFF, 01=TONE, 02=TSQL, 03=DTCS, 04=TSQL-R, 05=DTCS-R, 06=DTCS (T), 07=TONE (T)/DTCS (R), 08=DTCS (T)/TSQL (R), 09=TONE (T)/TSQL (R)

Cmd.	Sub cmd.	Data	Description		
18	00		Turning OFF the transceiver		
	01		Turning ON the transceiver*2		
19	00		Read transceiver ID		
1B	00	see p. 10-22	Send/read Repeater tone frequency		
	01	see p. 10-22	Send/read Tone squelch frequency		
	02	see p. 10-22	Send/read DTCS code and polarity		
	07	see p. 10-22	Send/read CSQL code (DV mode)		
1C	00	00	Send/read Transceiver's status (RX)		
		01	Send/read Transceiver's status (TX)		
1F	00	see p. 10-22	Send/read DV MY call sign		
	01	see p. 10-22	Send/read DV TX call signs		
	02	see p. 10-22	Send/read DV TX message		
20	00	00	00*3	Send/read Auto DV RX Call signs output OFF	
			01*3	Send/read Auto DV RX Call signs output ON	
		01	01	see p. 10-23	Output DV RX Call signs for transceiver
			02	see p. 10-23	Read DV RX Call signs for transceiver
	01	00	00*3	Send/read Auto DV RX message output OFF	
			01*3	Send/read Auto DV RX message output ON	
		01	01	see p. 10-23	Output DV RX message for transceiver
			02	see p. 10-23	Read DV RX message for transceiver
	02	00	00*3	Send/read Auto DV RX status output OFF	
			01*3	Send/read Auto DV RX status output ON	
01		01	see p. 10-23	Output DV RX status for transceiver	
		02	see p. 10-23	Read DV RX status for transceiver	
03	00	00	Send/read Auto DV RX GPS/D-PRS data output OFF		
		01	Send/read Auto DV RX GPS/D-PRS data output ON		
	01	01	see p. 10-24	Output DV RX GPS/D-PRS data for transceiver	
		02	see p. 10-24	Read DV RX GPS/D-PRS data for transceiver	
04	00	00	Send/read Auto DV RX GPS/D-PRS message output OFF		
		01	Send/read Auto DV RX GPS/D-PRS message output ON		
	01	01	see p. 10-26	Output DV RX GPS/D-PRS message for transceiver	
		02	see p. 10-26	Read DV RX GPS/D-PRS message for transceiver	

Remote jack (CI-V) information (Continued)

Cmd.	Sub cmd.	Data	Description
22	00	see p. 10-26	Send/read DV TX data (Up to 30 byte)
01	00	00	Send/read Auto DV RX data output OFF
		01	Send/read Auto DV RX data output ON
	01	see p. 10-26	Send/read DV RX data (Up to 30 byte)
02		00, 01	Send/read DV data TX setting (00=PTT, 01=Auto)
03		00, 01	Send/read DV fast data setting (00=OFF, 01=ON)
04		00, 01	Send/read GPS Data Speed setting (00=Slow, 01=Fast)
05		00~10	Send/read TX Delay (PTT) setting (00=OFF, 01=1 sec. ~ 10=10 sec.)
23	00	see p. 10-26	Read the position
01		00	Send/read the GPS receiver OFF
		01	Send/read the internal GPS ON
		02	Send/read the external GPS ON
		03	Send/read the manually entered position
02		see p. 10-26	Send/read manually entered position
24	00	00	Send/read TX output power setting OFF
		01	Send/read TX output power setting ON
	01	00	TX output power setting OFF for transceiver
	01	TX output power setting ON for transceiver	

*1 Below 100 Hz is omitted.

*2 When sending the power ON command (18 01), the command "FE" must be sent before the basic format.

- 19200bps: 25
- 9600bps: 13
- 4800bps: 7

Example: When sending with 4800 bps

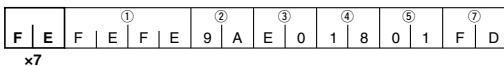

- ① Preamble code (fixed)
- ② Transceiver's default address
- ③ Controller's default address
- ④ Command number
- ⑤ Sub command number
- ⑦ End of message code (fixed)

*3 Output setting is automatically turned OFF after turning OFF the transceiver, then turn it ON again.

Receive frequency setting

Command: **00, 03, 05**

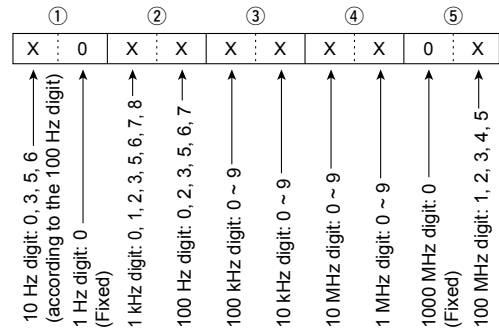

100 Hz digit	10 Hz digit
0	0
2	5
3	3
5	0
6	6
7	5

Operating mode

Command: **01, 04, 06**

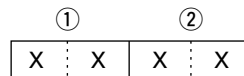

Operating mode	① Mode	② Filter setting
AM	02	01
AM-N	02	02
FM	05	01
FM-N	05	02
DV	17	01

Duplex Frequency offset setting

Command: **0C, 0D**

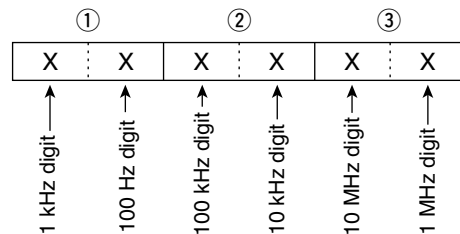

RF power level setting

Command: **14 0A**

LOW	MID	HIGH
0 ~ 84	85 ~ 170	171 ~ 255

External microphone gain setting

Command: **14 0B**

1	2	3	4
0000 ~ 0063	0064 ~ 0127	0128 ~ 0191	0192 ~ 0255

Remote jack (CI-V) information (Continued)

VOX gain setting

Command: **14 16**

OFF	1	2	3	4
0000 ~ 0022	0023 ~ 0046	0047 ~ 0069	0070 ~ 0092	0093 ~ 0115
5	6	7	8	9
0016 ~ 0139	0140 ~ 0162	0163 ~ 0185	0186 ~ 0208	0209 ~ 0232
10				
0233 ~ 0255				

Repeater tone/tone squelch frequency setting

Command: **1B 00, 1B 01**

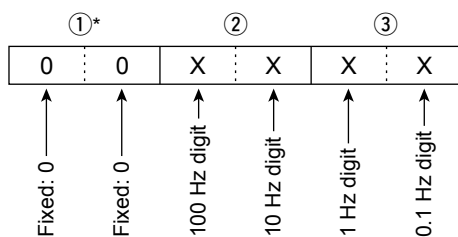

*Not necessary when setting a frequency.
 ① See page 9-16 for the tone frequency list.

DTCS code and polarity setting

Command: **1B 02**

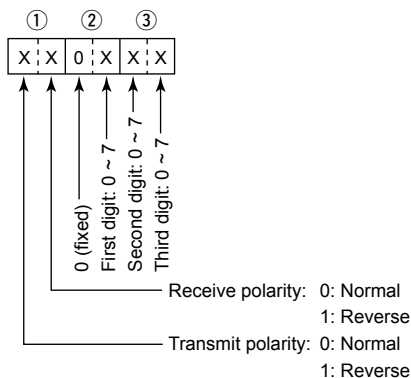

① See page 9-16 for the DTCS code list.

Digital code squelch setting

Command: **1B 07**

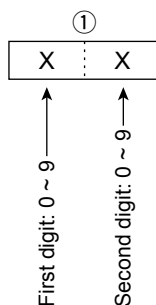

DV MY call sign setting

Command: **1F 00**

Set your own call sign and note of up to 12 characters.

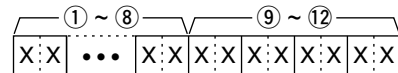

① ~ ⑧: Your own call sign setting (8 characters)
 ⑨ ~ ⑫: Note setting (4 characters)

DV TX call signs setting (24 characters)

Command: **1F 01**

Set "UR," "R1" and "R2" call signs of 8 characters (fixed).

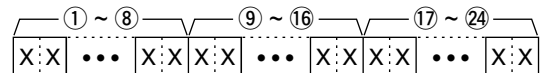

① ~ ⑧: UR (Destination) call sign setting (8 characters)
 ⑨ ~ ⑯: R1 (Access/Area repeater) call sign setting (8 characters)
 ⑰ ~ ⑳: R2 (Link/Gateway repeater) call sign setting (8 characters)

Character's code of the call sign

Character	ASCII code
0 ~ 9	30 ~ 39
A ~ Z	41 ~ 5A
(Space)	20
/	2F

DV TX message setting

Command: **1F 02**

Set the transmit message of up to 20 characters.
 "FF" stops sending or reading messages.

Character	ASCII code	Character	ASCII code
A ~ Z	41 ~ 5A	a ~ z	61 ~ 7A
0 ~ 9	30 ~ 39	Space	20
!	21	#	23
\$	24	%	25
&	26	\	5C
?	3F	"	22
'	27	`	60
^	5E	+	2B
-	2D	*	2A
/	2F	.	2E
,	2C	:	3A
;	3B	=	3D
<	3C	>	3E
(28)	29
[5B]	5D
{	7B	}	7D
!	7C	_	5F
-	7E	@	40

Remote jack (CI-V) information (Continued)

DV RX call sign data

Command: **20 0001, 20 0002**

① Header flag data (First byte)

Data		Description
bit7	(0: Fixed)	—
bit6	(0: Fixed)	—
bit5	(0: Fixed)	—
bit4	0/1	0=Voice, 1=Data
bit3	0/1	0=Direct, 1=Through repeater
bit2	0/1	0=No Break-in, 1=Break-in
bit1	0/1	0=Data, 1=Control
bit0	0/1	0=Normal, 1=EMR

② Header flag data (Second byte)

Data			Description
bit2	bit1	bit0	
1	1	1	Repeater control
1	1	0	Send auto acknowledge
1	0	1	(Not used)
1	0	0	Request to re-transmit
0	1	1	Send acknowledge
0	1	0	Receive no reply
0	0	1	Repeater disabled
0	0	0	NULL

- ③ ~ ⑩: Call sign of the caller station (8 characters, fixed)
- ⑪ ~ ⑭: Note of the caller station (4 characters, fixed)
- ⑮ ~ ⑳: Call sign of the called station (8 characters, fixed)
- ㉓ ~ ㉖: Call sign of the access/area repeater (R1) (8 characters, fixed)
- ㉗ ~ ㉚: Call sign of the link/gateway repeater (R2) (8 characters, fixed)
- ① "FF" stands for no call sign receiving after turning ON the transceiver.

DV RX message

Command: **20 0101, 20 0102**

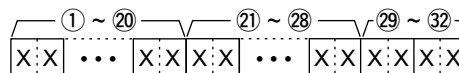

- ① ~ ⑳: Message (20 characters)
- ㉑ ~ ㉘: Call sign of the caller station (8 characters)
- ㉙ ~ ㉚: Note of the caller station (4 characters)
- ① FF: When no call sign is received since the transceiver power ON.

Example: When a Gateway call is received

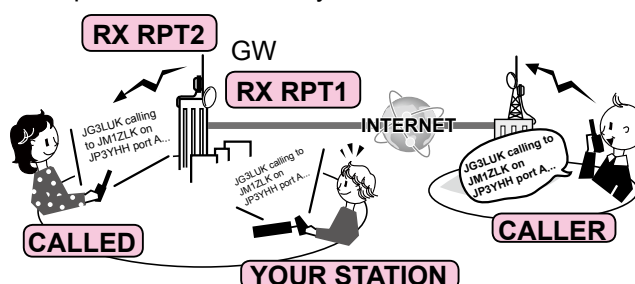

- CALLER: Caller's call sign
- CALLED: Called station call sign
- RXRPT1: Call sign of the repeater that was accessed by the caller station
 - ① If it was a call through a gateway and the internet, this item displays the gateway call sign of the repeater you received the call from.
- RXRPT2: Call sign of the repeater you received the call from

DV RX Status setting

Command: **20 0201, 20 0202**

Data	Function	Description
bit7	0 (Fixed)	—
bit6	0/1	Receiving a voice call While receiving a digital voice signal, select "1." (Regardless of DSQL and CSQL setting)
bit5	0/1	Last call finisher When the last call was finished by you, select "1."
bit4	0/1	Receiving a signal When the audio tone can be heard, select "1."
bit3	0/1	Receiving a BK call While receiving a BK call, select "1."
bit2	0/1	Receiving a EMR call While receiving a EMR call, select "1."
bit1	0/1	Receiving a signal other than DV When "DV" and "FM" are blinking, select "1."
bit0	0/1	Packet loss status While displaying packet loss status

Remote jack (CI-V) information (Continued)

GPS/D-PRS data— Position
 Command: **20 03 01, 20 03 02**

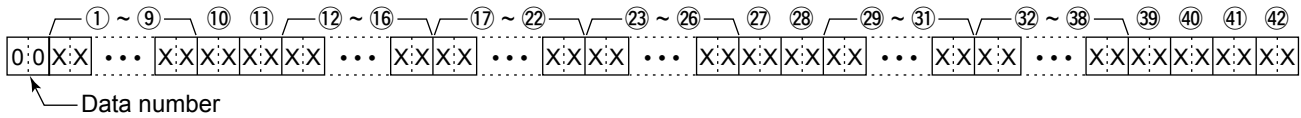

- ① ~ ⑨: Call sign/SSID
*9 ASCII characters (A–Z, 0–9, /, -, space)
- ⑩, ⑪: Symbol
*2 ASCII characters (00h–EFh)
- ⑫ ~ ⑯: Latitude (dd°mm.mmm format)
- ⑰ ~ ⑳: Longitude (ddd°mm.mmm format)
- ㉓ ~ ㉖: Altitude (0.1 meter steps)
- ㉗, ㉘: Course (1 degree steps)
- ㉙ ~ ㉛: Speed (0.1 km/h steps)
- ㉜ ~ ㉟: Date (UTC: yyyyymmddHHMMSS)
*y: Year, m: Month, d: Day, H: Hour, M: Minute, S: Second
- ㉿: Power (see the table to the right)
- ④①: Height (see the table to the right)
- ④②: Gain (see the table to the right)
- ④③: Directivity (see the table to the right)

Data	Power (W)	Height (m/ft)	Gain (dB)	Directivity (deg)
0	0	3/10	0	Omni-direction
1	1	6/20	1	45° NE
2	4	12/40	2	90° E
3	9	24/80	3	135° SE
4	16	49/160	4	180° S
5	25	98/320	5	225° SW
6	36	195/640	6	270° W
7	49	390/1280	7	315° NW
8	64	780/2560	8	360° N
9	81	1561/5120	9	—

GPS/D-PRS data— Object
 Command: **20 03 01, 20 03 02**

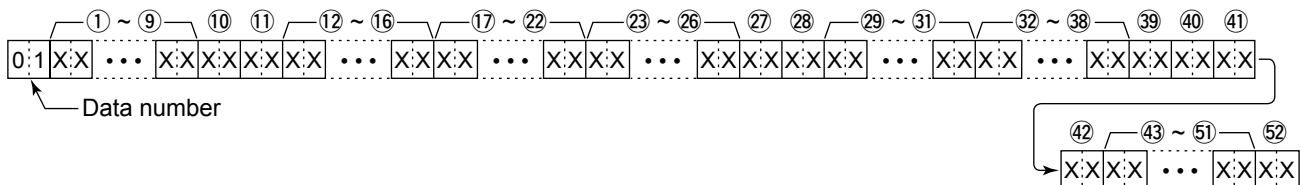

- ① ~ ⑨: Call sign/SSID
*9 ASCII characters (A–Z, 0–9, /, -, space)
- ⑩, ⑪: Symbol
*2 ASCII characters (00h–EFh)
- ⑫ ~ ⑯: Latitude (dd°mm.mmm format)
- ⑰ ~ ⑳: Longitude (ddd°mm.mmm format)
- ㉓ ~ ㉖: Altitude (0.1 meter steps)
- ㉗, ㉘: Course (1 degree steps)
- ㉙ ~ ㉛: Speed (0.1 km/h steps)
- ㉜ ~ ㉟: Date (UTC: yyyyymmddHHMMSS)
*y: Year, m: Month, d: Day, H: Hour, M: Minute, S: Second
- ㉿: Power (see the table to the right)
- ④①: Height (see the table to the right)
- ④②: Gain (see the table to the right)
- ④③: Directivity (see the table to the right)
- ④④ ~ ④⑥: Name
*9 ASCII characters (00h–EFh)
- ④⑦: Type (1=Live, 0=Killed)

Data	Power (W)	Height (m/ft)	Gain (dB)	Directivity (deg)
0	0	3/10	0	Omni-direction
1	1	6/20	1	45° NE
2	4	12/40	2	90° E
3	9	24/80	3	135° SE
4	16	49/160	4	180° S
5	25	98/320	5	225° SW
6	36	195/640	6	270° W
7	49	390/1280	7	315° NW
8	64	780/2560	8	360° N
9	81	1561/5120	9	—

Remote jack (CI-V) information (Continued)

GPS/D-PRS data— Item

Command: 20 03 01, 20 03 02

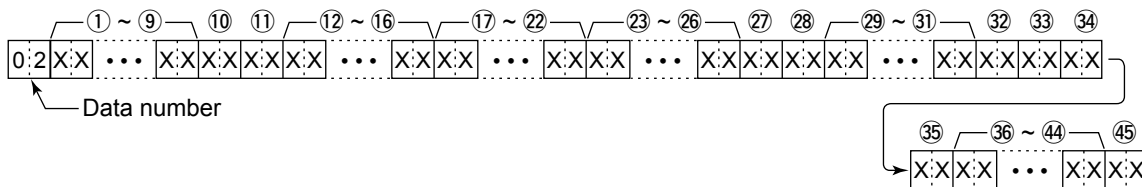

- ① ~ ⑨: Call sign/SSID
*9 ASCII characters (A–Z, 0–9, /, -, space)
- ⑩, ⑪: Symbol
*2 ASCII characters (00h–EFh)
- ⑫ ~ ⑯: Latitude (dd°mm.mmm format)
- ⑰ ~ ⑳: Longitude (ddd°mm.mmm format)
- ㉓ ~ ㉖: Altitude (0.1 meter steps)
- ㉗, ㉘: Course (1 degree steps)
- ㉙ ~ ㉛: Speed (0.1 km/h steps)
- ㉜: Power (see the table to the right)
- ㉝: Height (see the table to the right)
- ㉞: Gain (see the table to the right)
- ㉟: Directivity (see the table to the right)
- ㊱ ~ ㊴: Name
*9 ASCII characters (00h–EFh)
- ㊵: Type (1=Live, 0=Killed)

Data	Power (W)	Height (m/ft)	Gain (dB)	Directivity (deg)
0	0	3/10	0	Omni-direction
1	1	6/20	1	45° NE
2	4	12/40	2	90° E
3	9	24/80	3	135° SE
4	16	49/160	4	180° S
5	25	98/320	5	225° SW
6	36	195/640	6	270° W
7	49	390/1280	7	315° NW
8	64	780/2560	8	360° N
9	81	1561/5120	9	—

GPS/D-PRS data— Weather

Command: 20 03 01, 20 03 02

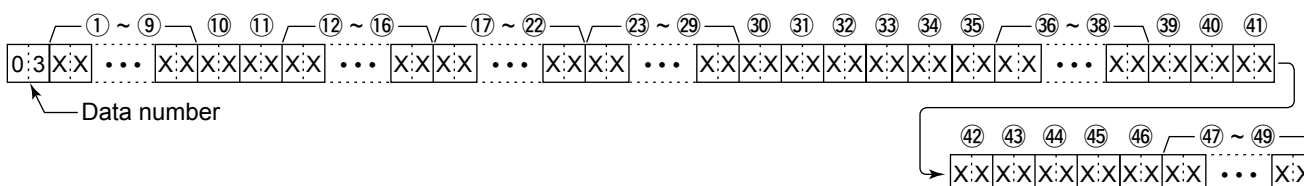

- ① ~ ⑨: Call sign/SSID
*9 ASCII characters (A–Z, 0–9, /, -, space)
- ⑩ ~ ⑪: Symbol
*2 ASCII characters (00h–EFh)
- ⑫ ~ ⑯: Latitude (dd°mm.mmm format)
- ⑰ ~ ⑳: Longitude (ddd°mm.mmm format)
- ㉓ ~ ㉙: Date (UTC: yyyyymmddHHMMSS)
*y: Year, m: Month, d: Day, H: Hour, M: Minute, S: Second
- ㉚, ㉛: Wind direction (1 degree steps)
- ㉜, ㉝: Wind speed (0.1 m/s steps)
- ㉞, ㉟: Gust speed (0.1 m/s steps)
- ㊱ ~ ㊲: Temperature (0.1°C steps)
- ㊳ : Temperature (0=+ degree, 1=- degree)
- ㊴, ㊵: Rainfall (0.1 mm steps)
- ㊶, ㊷: Rainfall (24 hours) (0.1 mm steps)
- ㊸, ㊹: Rainfall (Midnight) (0.1 mm steps)
- ㊺, ㊻: Humidity (1% steps)
- ㊼ ~ ㊾: Barometric pressure (0.1 hPa steps)

Remote jack (CI-V) information (Continued)

GPS/D-PRS message

Command: **20 04 01, 20 04 02**

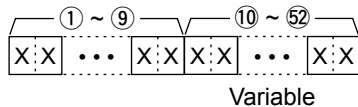

- ① ~ ⑨: Call sign/SSID
*9 ASCII characters (A ~ Z, 0 ~ 9, /, -, space)
- ⑩ ~ ⑫: Message
*Up to 43 ASCII characters (00h~EFh)

DV TX data, DV RX data (transceive)

Command: **22 00, 22 01 01**

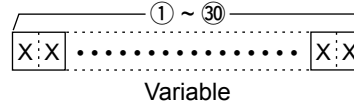

- ① ~ ⑩: Tx, data Rx data (Up to 30 Byte)
**“FA” to “FF” are entered after converted to “FF 0A” to “FF 0F” automatically. Up to 60 Byte data can be entered in this case.

MY position data

Command: **23 00**

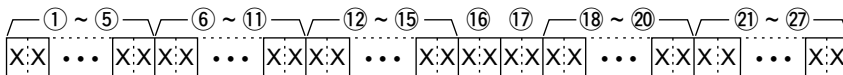

- ① ~ ⑤: Latitude (dd°mm.mmm format)
- ⑥ ~ ⑪: Longitude (ddd°mm.mmm format)
- ⑫ ~ ⑮: Altitude (0.1 meter steps)
- ⑯, ⑰: Course (1 degree steps)
- ⑱ ~ ⑳: Speed (0.1 km/h steps)
- ㉑ ~ ㉓: Date (UTC: yyyyymmddHHMMSS)
*y: Year, m: Month, d: Day, H: Hour, M: Minute, S: Second

Manually entered position data

Command: **23 02**

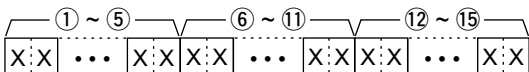

- ① ~ ⑤: Latitude (dd°mm.mmm format)
- ⑥ ~ ⑪: Longitude (ddd°mm.mmm format)
- ⑫ ~ ⑮: Altitude (0.1 meter steps)

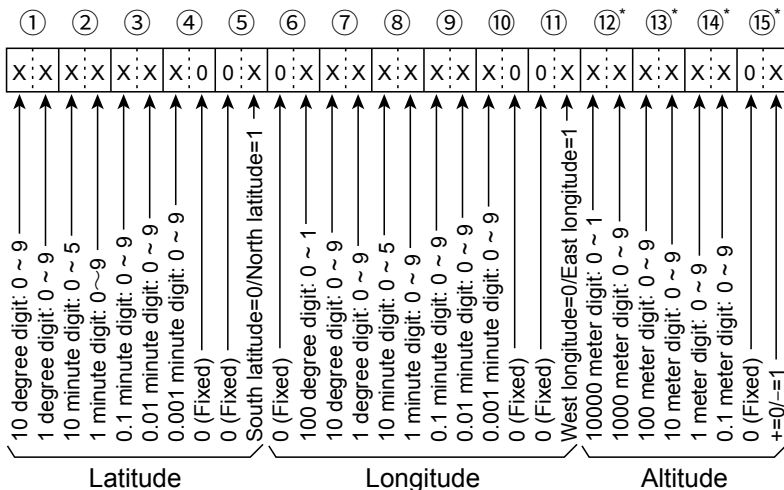

* “FF” in all 4-byte characters stands for no altitude data sending or receiving.

Section 11 OPTIONS

Options11-2

Options

Microphone/Speaker

HM-154	HAND MICROPHONE
HM-207S	HAND MICROPHONE (REMOTE-CONTROL)
HM-209	NOISE CANCELING MICROPHONE
HM-232	HAND MICROPHONE (SIMPLE)
OPC-440	MIC EXTENSION CABLE: 5 m (16.4 ft)*
OPC-647	MIC EXTENSION CABLE: 2.5 m (8.2 ft)*
SP-30	EXTERNAL SPEAKER: 2.8 m (9.1 ft)*
SP-35	EXTERNAL SPEAKER: 2 m (6.5 ft)*
SP-35L	EXTERNAL SPEAKER: 6 m (19.6 ft)*

*Approximate

Software

CS-4100	CLONING SOFTWARE
RS-MS1A	Android™ APPLICATION
RS-MS1I	iOS™ APPLICATION
RS-MS3W	TERMINAL MODE/ACCESS POINT MODE SOFTWARE: For Windows
RS-MS3A	TERMINAL MODE/ACCESS POINT MODE APPLICATION: For Android™ devices
OPC-2350LU	DATA CABLE: USB type
OPC-478UC	CLONING CABLE: USB type

Bluetooth

UT-137	Bluetooth® UNIT
VS-3	Bluetooth® HEADSET

Others

MBA-8	CONTROLLER BRACKET
MBF-1	MOUNTING BASE: MBA-8 is required
MBF-4	MOBILE BRACKET
OPC-345	DC POWER CABLE
OPC-589	MIC ADAPTOR CABLE
OPC-1156	CONTROLLER EXTENSION CABLE: 3.5 m (11.4 ft)

About the free download software

You can download each manual and guide from the Icom website.

<http://www.icom.co.jp/world/support/>

Before using, read each manual and guide, and use it according to the instructions.

① Information

- To use the software, the following items are required.

CS-4100	microSD card OPC-2350LU OPC-478UC
RS-MS1A	UT-137
RS-MS1I	UT-137
RS-MS3A	OPC-2350LU
RS-MS3W	OPC-2350LU

- To add or expand a function, or to improve the performance, the software version may be upgraded. Before you update your software version, see the instructions and cautions described on the Icom website.
- To use the RS-MS3W or RS-MS3A, see “About the DV Gateway function” that can be downloaded from the Icom website.

Icom is not responsible for the destruction, damage to, or performance of any Icom or non-Icom equipment, if the malfunction is because of:

- Force majeure, including, but not limited to, fires, earthquakes, storms, floods, lightning, other natural disasters, disturbances, riots, war, or radioactive contamination.
- The use of Icom transceivers with any equipment that is not manufactured or approved by Icom.

Section 12 Bluetooth® OPERATION

Bluetooth® operations.....	12-2
Turning ON the Bluetooth® function	12-2
Connecting to a Bluetooth® headset.....	12-3
VOX function	12-4
◇ Using the VOX function	12-4
◇ Setting the VOX level.....	12-4
◇ VOX-related settings.....	12-5
Other settings of the headset	12-6
◇ AF Output	12-6
◇ Headset Function Select.....	12-6
◇ About the Icom headset (VS-3)	12-7
Downloading the RS-MS1A from the Google Play store	12-8
◇ Required items.....	12-8
◇ Download procedures	12-8
Downloading the RS-MS1I from the Apple App store.....	12-9
◇ Required items.....	12-9
◇ Download procedures	12-9
Connecting to an Android™ device	12-10
◇ Pairing with an Android™ device	12-10
◇ Connection.....	12-11
Connecting to an iOS™ device	12-12
◇ Pairing with an iOS™ device	12-12
◇ Connection.....	12-13
Disconnecting from a Bluetooth® device	12-14
Deleting a Bluetooth® device from the pairing list.....	12-15
Editing the installed Bluetooth® unit name.....	12-16
Initializing the installed Bluetooth® unit.....	12-17
The maximum number of paired devices	12-18

Bluetooth® operations

If you install the optional UT-137 Bluetooth® UNIT in the transceiver, you can connect to other Bluetooth devices.

In this section, the ID-4100A/E with the UT-137 is described as simply the “transceiver.”

You can connect other devices to the transceiver.

Icom Headset

When you connect the VS-3 Bluetooth® HEADSET to the transceiver, you can wirelessly transmit and receive. The VS-3 has a [PTT] switch, so you can transmit in the same way as using the transceiver’s [PTT] switch. The VOX function can also be used, so you can select transmit and receive by using your voice through the headset to switch between TX and RX.

You can assign a function to the keys on the side panel of the VS-3 to remotely operate the transceiver.

Android™ device

When you connect an Android device to the transceiver, you can use the extended D-STAR functions with the RS-MS1A (freeware Android application).

iOS™ device

When you connect an iOS device to the transceiver, you can use the extended D-STAR functions with the RS-MS1I (freeware iOS application).

① The communication range of Bluetooth is approximately 10 meters (32.8 feet).

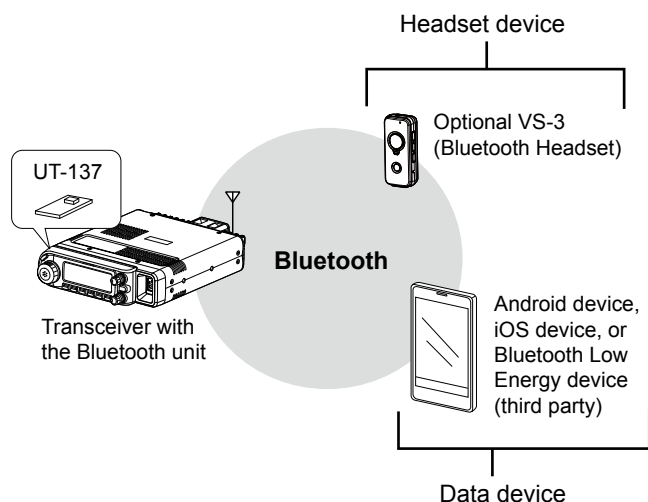

Turning ON the Bluetooth® function

Bluetooth Set > Bluetooth

1. Push [MENU].
2. Rotate [DIAL] to select “Bluetooth Set,” then push [↵].



3. Select “Bluetooth,” then push [↵].

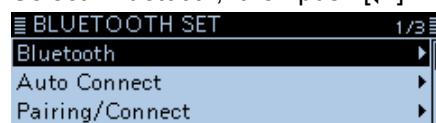

4. Select “ON,” then push [↵].



5. Push [MENU].
 - Returns to the standby screen.

IMPORTANT: The Bluetooth communication range may vary, depending on the environment in which the device operates. Microwave ovens or Wireless LAN may cause an interference.

In that case, stop using those devices or increase the space between the Bluetooth device and the other devices.

This Bluetooth device has a range of use. If the communication is unstable, use the device within the range.

Connecting to a Bluetooth® headset

You can connect the optional Bluetooth headset to the transceiver.

Step 1. Selecting the pairing mode of the headset.

See the instruction manual of the headset to select the pairing mode.

Step 2. Searching for the headset (Transceiver)

Bluetooth Set > Pairing/Connect

1. Push [MENU].
2. Rotate [DIAL] to select "Bluetooth Set," then push [↵].

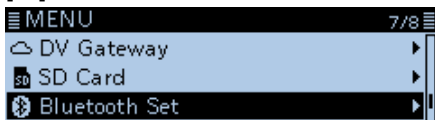

3. Select "Pairing/Connect," then push [↵].

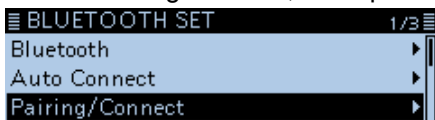

4. Select "Device Search," then push [↵].



5. Select "Search Headset," then push [↵].

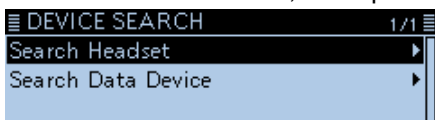

• Displays the usable headsets in the pairing list.
(Example: ICOM BT-002)

6. Select "ICOM BT-002," then push [↵].



• The confirmation dialog "Connect?" is displayed.

7. Select <YES>, then push [↵].

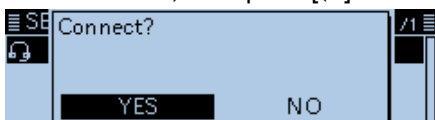

- Connects to the headset.
- After the connecting to the headset,  is displayed in the pairing list.

Pairing List

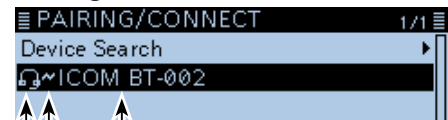

Device name
("ICOM" indicate the Icom headset.)

Displayed while connecting

Headset icon

8. Push [MENU].
 - Returns to the standby screen.
 - ① While connected to a Bluetooth device, the Bluetooth icon is displayed.

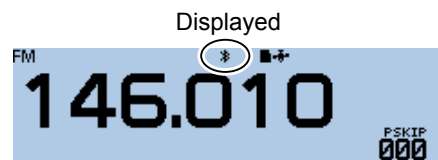

TIP:

- When you turn ON the transceiver with "Auto Connect" set to ON, the transceiver automatically connects to the last paired device. (Default: ON) (Bluetooth Set > **Auto Connect**)
After connecting, the following dialog is displayed.

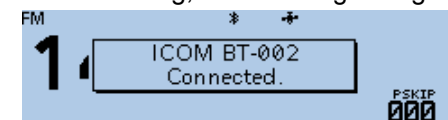

- When the transceiver cannot find a connectable headset, and "No Device Found" is displayed on the screen, push [QUICK], then select "Re-search" to search again for a headset.



Push [QUICK]

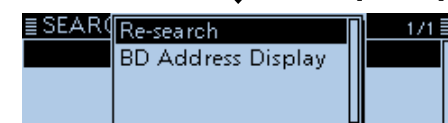

VOX function

The Voice Operated eXchange (VOX) function toggles the transceiver between transmit and receive by your voice. This function provides hands-free operation. You can use the VOX function with the optional VS-3 or a third party's Bluetooth headset.

Depending on the headset, the VOX function may be disabled because of the differences in microphones.

◇ Using the VOX function

Bluetooth Set > Headset Set > VOX > **VOX**

1. Push [MENU].
2. Rotate [DIAL] to select "Bluetooth Set," then push [↵].

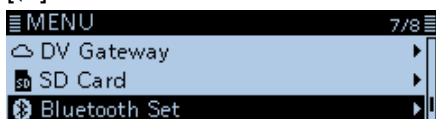

3. Select "Headset Set," then push [↵].

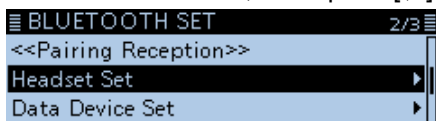

4. Select "VOX," then push [↵].

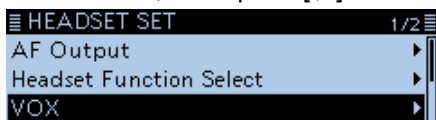

5. Select "VOX," then push [↵].



6. Select "ON," then push [↵].



7. Push [MENU].
 - Returns to the standby screen.
 - Displays "V."

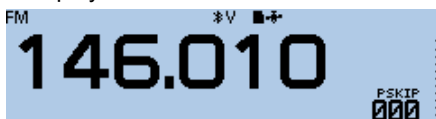

NOTE: While receiving a signal or sounding a beep, the transceiver does not switch to transmit by your voice.

If the transceiver does not connect to a Bluetooth headset, you cannot use the VOX function, even if the "VOX" item is set to ON. Be sure to check the Bluetooth connection between the transceiver and the headset before using the VOX function.

◇ Setting the VOX level

Bluetooth Set > Headset Set > VOX > **VOX Level**

1. Push [MENU].
2. Rotate [DIAL] to select "Bluetooth Set," then push [↵].
3. Select "Headset Set," then push [↵].
4. Select "VOX," then push [↵].
5. Select "VOX Level," then push [↵].



6. While speaking into the headset microphone, rotate [DIAL] to adjust the VOX level.

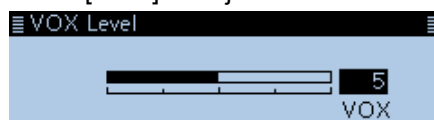

- Displays "VOX" when the TX level audio is input.
 - ① The VOX level can be adjusted between 1 (minimum) and 10 (maximum), or turned OFF. (Default: 5)
 - ① Higher values make the VOX function more sensitive to your voice.
7. Push [MENU].
 - Returns to the standby screen.

① Information

- If the S-meter does not display the output power level, and the transceiver does not transmit, adjust the VOX delay time in the Menu screen. (Bluetooth Set > Headset Set > VOX > **VOX Delay**)
- When the VOX function is ON, you can adjust the VOX level by pushing [+] or [-] on the VS-3 while transmitting.
- When the VOX function is ON, you can adjust the VOX level by rotating [DIAL] while transmitting.

NOTE: We recommend that you set the microphone gain on the MENU screen or the headset, before setting the VOX level. (Function > **MIC Gain**)

VOX function (Continued)

◆ VOX-related settings

You can set the “VOX Delay” and “VOX Time-Out Timer” on the MENU screen.

VOX Delay



Bluetooth Set > Headset Set > VOX > **VOX Delay**

The VOX delay is the amount of time the transmitter stays ON after you stop speaking. It enables for normal pauses in speaking. (p. 9-70)

VOX Time-Out Timer

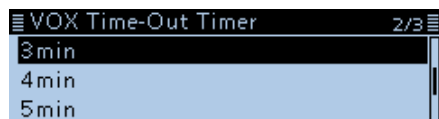

Bluetooth Set > Headset Set > VOX > **VOX Time-Out Timer**

The VOX Time-Out Timer prevents accidental prolonged transmission. (p. 9-70)

Other settings of the headset

◇ AF Output

Select the AF Output device

If “AF Output” is set to “Headset & Speaker,” you can hear audio from both a connected Bluetooth headset and the transceiver’s speaker.

Bluetooth Set > Headset Set > AF Output

1. Push [MENU].
2. Rotate [DIAL] to select “Bluetooth Set,” then push [↵].

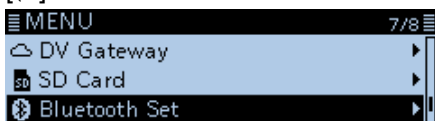

3. Select “Headset Set,” then push [↵].

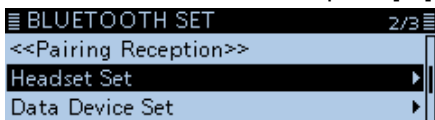

4. Select “AF Output,” then push [↵].

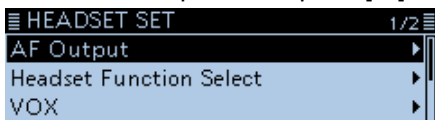

5. Select “Headset & Speaker,” then push [↵].

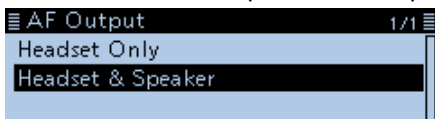

6. Push [MENU].
 - Returns to the standby screen.
 - ① Audio is heard from both the connected Bluetooth headset and the transceiver’s speaker.

◇ Headset Function Select

Select the PTT and microphone combination

when either a Bluetooth headset or the transceiver microphone are used.

Bluetooth Set > Headset Set > Headset Function Select

1. Push [MENU].
2. Rotate [DIAL] to select “Bluetooth Set,” then push [↵].



3. Select “Headset Set,” then push [↵].

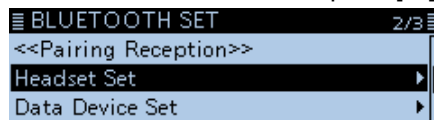

4. Select “Headset Function Select,” then push [↵].

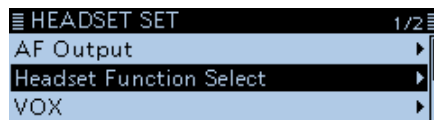

5. Select an option, then push [↵].

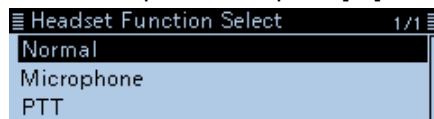

6. Push [MENU].
 - Returns to the standby screen.

NOTE:

- When you select “PTT,” turn OFF the VOX function.
- **DO NOT** select “PTT” when you use only the Bluetooth headset.

Using the Bluetooth headset as a microphone
(Select “Microphone”)



Using the Bluetooth headset as a PTT
(Select “PTT”)

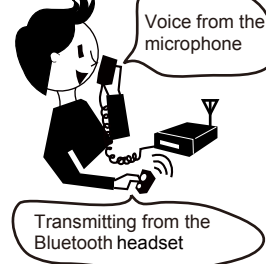

Other settings of the headset (Continued)

◇ About the Icom headset (VS-3)

You can set the detailed settings of the optional VS-3 Bluetooth HEADSET.

Also, you can assign a key function to [PLAY], [FWD], and [RWD] on the VS-3's "Custom Key" screen.

Power Save screen

The Power Save function temporarily disconnects the Bluetooth connection if no communication or operation is performed for 120 seconds. (p. 9-70)

The Power Save function is disabled when the VOX function is ON.

One-Touch PTT screen

The One-Touch PTT function enables you to select transmission and reception by pushing [PTT].

PTT Beep screen

Set the beep to sound when you push [PTT] on the VS-3. (p. 9-70)

Custom Key Beep screen

Set the beep to sound when you push [PLAY], [FWD] or [RWD] on the VS-3. (p. 9-70)

Custom key screen

You can assign a key function to [PLAY], [FWD] and [RWD] on the VS-3. (p. 9-71)

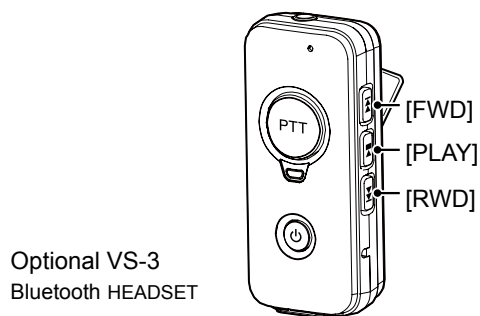

"Custom Key" screen



Downloading the RS-MS1A from the Google Play store

The RS-MS1A is a freeware application for Android devices.

With the RS-MS1A, you can use the extended D-STAR functions to exchange pictures or messages, or display the received D-PRS station data on a map application.

To use the RS-MS1A, download it from the Google™ Play store installed in your Android device.

◇ Required items

Android™ device

You can use the RS-MS1A with devices that have Android 4.0 or later installed.

The RS-MS1A has been tested with the Android 4.x.x, 5.x.x, and 6.x.x. (As of April 2017)

① Information

- Some function may not work correctly, depending on the application installed in your Android device or memory capability, even if you use one of the above products.
- See the instruction manual for details of the operation or account setting of the Android device.
- The screen shot in this manual may differ, depending on your device's OS or its version.

◇ Download procedures

1. Turn ON your Android device.
2. Tap "Play Store."
3. Enter "RS-MS1A" in the "Search Google Play" field.
4. Tap "🔍."

 - Displays "RS-MS1A" in the application list.

5. Tap "RS-MS1A."

 - Displays the introduction screen of the RS-MS1A.

6. Tap <INSTALL>.
7. Tap <ACCEPT> in the "App permissions" window.

 - Installation starts.
 - After finishing the installation, the RS-MS1A icon is displayed on the screen.



← RS-MS1A icon

Downloading the RS-MS1I from the Apple App store

The RS-MS1I is a freeware application for iOS devices.

With the RS-MS1I, you can use the extended D-STAR functions to exchange pictures or messages, or display the received D-PRS station data on a map application.

To use the RS-MS1I, download it from the Apple App store installed in your iOS device.

◇ Required items

iOS device

You can use the RS-MS1I with the iPhone or iPad that have iOS 8.0.1 or later installed.

① Information

- Some function may not work correctly, depending on the application installed in your iOS device or memory capability, even if you use one of the above products.
- See the instruction manual for details of the operation or account setting of the iOS device.
- The screen shot in this manual may differ, depending on your device's OS or its version.

◇ Download procedures

1. Turn ON your iOS device.
2. Tap "App Store."
3. Tap "🔍."
4. Enter "RS-MS1I" in the search field.
 - Displays "RS-MS1I" in the application list.
5. Tap "RS-MS1I."
 - Displays the introduction screen of the RS-MS1I.
6. Tap <GET>.
7. Tap <INSTALL>.
 - Installation starts.
 - After finishing the installation, the RS-MS1I icon is displayed on the screen.



Connecting to an Android™ device

Before connecting to an Android™ device, you must pair with it.

- How to pair (see below)
- How to connect (p. 12-11)

◆ Pairing with an Android™ device

This section describes how to pair with an Android device.

NOTE: Depending on the device, you may not be able to pair with the Bluetooth device.

Step 1. Entering the pairing reception mode (Transceiver)

Bluetooth Set > <<Pairing Reception>>

1. Push [MENU].
2. Rotate [DIAL] to select “Bluetooth Set,” then push [↵].

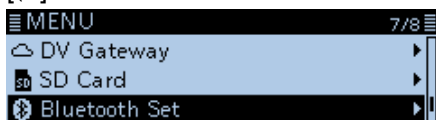

3. Select “<<Pairing Reception>>,” then push [↵].

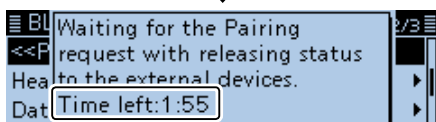
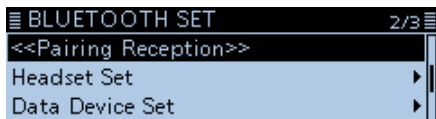

Turn ON Bluetooth with your Android device within the displayed period of time. When the time runs out, the transceiver exits the Pairing reception mode.

Step 2. Turning ON Bluetooth (Android device)

Turn ON Bluetooth with your Android device.

- The Android device displays the UT-137 Bluetooth® UNIT name.
- ① See the instruction manual of the Android device for details.
- ① You can confirm the UT-137's name on the BLUETOOTH DEVICE INFORMATION screen. (Default: ICOM BT-003) (p. 9-72)

Step 3. Sending a pairing request to the transceiver (Android device)

Select the displayed UT-137's name to send a pairing request.

- The Android device starts to send a pairing request.
- The Android device displays the “To pair with: ICOM BT-003. Make sure it is showing this passkey: * * * * *” dialog.

Step 4. Receiving a pairing request (Transceiver)

1. When the transceiver receives a pairing request, confirm the displayed passkey is the same as yours, and then, push [↵].

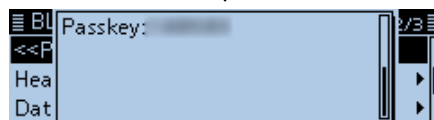
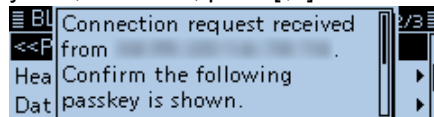

- Pairing starts.
2. Select “Pairing/Connect,” then push [↵].

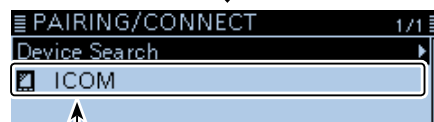
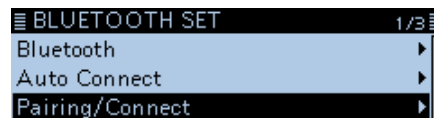

After the pairing is complete, the Android device name is displayed on the pairing list.

NOTE: When you pair with the third party's data device, entering a PIN code or passkey may be required. See the instruction manual of the data device for details to enter a PIN code or passkey.

Connecting to an Android™ device (Continued)

◇ Connection

This section describes how to connect to the transceiver from an Android device.

Step 1. Preparing for the connection (Transceiver)

Function > CI-V > **CI-V Transceive**

Set “CI-V Transceive” to ON to control the transceiver and the RS-MS1A with CI-V commands.

Step 2. Starting the RS-MS1A (Android device)

Tap the RS-MS1A to start.

① See page 12-8 for details on downloading the RS-MS1A.



← RS-MS1A icon

Step 3. Connecting to the transceiver (Android device)

Tap the UT-137 Bluetooth® UNIT name displayed on the RS-MS1A.

• Starts to connect.

- ① When your call sign has not been entered in the transceiver, you should enter in before you connect.
- ① After the connection has succeeded, the transceiver displays “*** Connected,” and the Bluetooth icon is displayed.

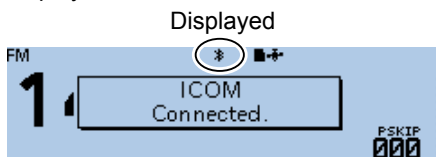

Displayed

① On the PAIRING/CONNECT screen, “” is displayed to the left of the Android device name.

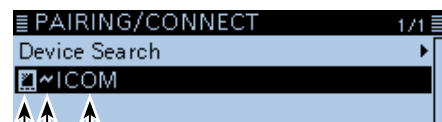

Device name

Displayed while connecting

Data device icon

TIP: To connect to the Android device from the transceiver:

When the RS-MS1A is started on the Android device, you can connect to the device from the transceiver.

Bluetooth Set > Pairing/Connect

1. Push [MENU].
2. Rotate [DIAL] to select “Bluetooth Set,” then push [↵].
3. Select “Pairing/Connect,” then push [↵].
4. Select the Android device name displayed in the pairing list, then push [↵].
5. Select <YES>, then push [↵].
 - Displays “*** Connecting...” (“***” is the Bluetooth name of the Android device.)
 - ① “” is displayed to the left of the Android device name.

NOTE: If you cannot connect, check that the same CI-V address is set between the transceiver and the RS-MS1A.

You can see the CI-V setting as described below:

Transceiver

“CI-V Address” in the Menu screen.

(Function > CI-V > **CI-V Address**) (Default: 9A)

RS-MS1A:

“Application Setting” → “CI-V setting” (Default: Transceiver[9A])

Connecting to an iOS™ device

Before connecting to an iOS device, you must pair with it.

- How to pair (see below)
- ① See page 12-13 to connect to the paired device.

◇ Pairing with an iOS™ device

NOTE: Depending on the device, you may not be able to pair with the Bluetooth device.

Step 1. Starting the RS-MS11 (iOS device)

1. Turn ON Bluetooth with your iOS device.
 - ① See the instruction manual of the iOS device for details.
2. Tap the RS-MS11 icon to start.
 - ① See page 12-9 for details on downloading the RS-MS1A.



- Displays the pairing device list.

Step 2. Entering the pairing reception mode (Transceiver)

Bluetooth Set > <<Pairing Reception>>

1. Push [MENU].
2. Rotate [DIAL] to select "Bluetooth Set," then push [↵].

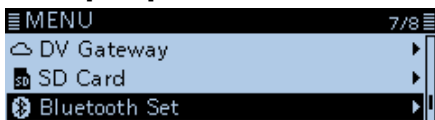

3. Select "<<Pairing Reception>>," then push [↵].

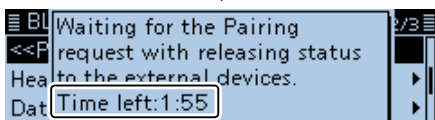
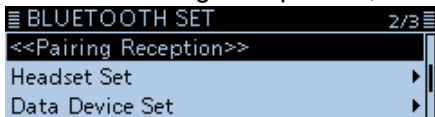

Turn ON Bluetooth with your iOS device within the displayed period of time. When the time runs out, the transceiver exits the Pairing reception mode.

NOTE: Before connecting, check the following items are correctly set.

- Set "CI-V Transceive" to "ON."
(Function > CI-V > **CI-V Transceive**)
- Set "Serialport Function" to "CI-V (Echo Back OFF)."
(Bluetooth Set > Data Device Set > **Serialport Function**)
- Set the same CI-V address between the transceiver and the RS-MS11.

Transceiver:

"CI-V Address" in the MENU screen
(Function > CI-V > **CI-V Address**) (Default: 9A)

RS-MS11:

"Application Setting" → "CI-V address"
(Default: Transceiver[9A])

Step 3. Sending a pairing request to the transceiver (iOS device)

1. On the RS-MS11, tap "Scan."
 • The device displays the UT-137 Bluetooth® UNIT name.
 ① You can confirm the UT-137's name on the BLUETOOTH DEVICE INFORMATION screen. (Default: ICOM BT-003) (p. 9-72)
2. Tap the displayed UT-137's name to send a pairing request.
 • The iOS device starts to send a pairing request.
 ① When your call sign has not been entered in the transceiver, you should enter in before you connect.
 ① After the connection has succeeded, the iOS device displays "Bluetooth connected to ICOM BT-003."

① **About the transceiver's display**

After the connection has succeeded, the transceiver displays "*** Connected." and the Bluetooth icon is displayed.

("***" is the Bluetooth name of the iOS device.)

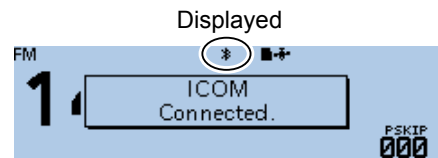

On the PAIRING/CONNECT screen, "FM" is displayed to the left of the iOS device name.

(Bluetooth Set > Pairing/Connect)

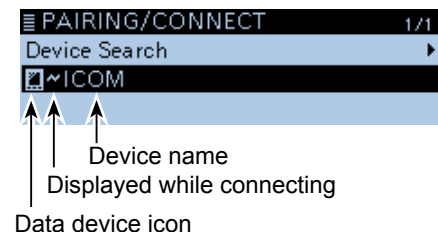

Connecting to an iOS™ device (Continued)

◇ **Connection**

This section describes how to connect to the paired transceiver from an iOS device.

1. Tap the RS-MS1I icon to start.

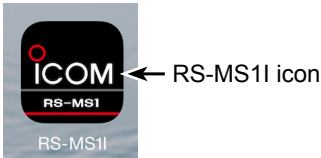

2. Tap "Other."
3. Tap "Bluetooth Connection."
4. Tap the displayed UT-137's name to connect.
 - The iOS device starts to connect to the transceiver.
 - ① When your call sign has not been entered in the transceiver, you should enter in before you connect.
 - ① After the connection has succeeded, the iOS device displays "Bluetooth connected to ICOM BT-003."

TIP: To connect to the iOS device from the transceiver:

When the RS-MS1I is started on the iOS device, you can connect to the device from the transceiver.

Bluetooth Set > **Pairing/Connect**

1. Push [MENU].
2. Rotate [DIAL] to select "Bluetooth Set," then push [↵].
3. Select "Pairing/Connect," then push [↵].
4. Select the iOS device name displayed in the pairing list, then push [↵].
5. Select <YES>, then push [↵].
 - Displays " * * * Connecting..."
 - (" * * *" is the Bluetooth name of the iOS device.)
 - ① "📶" is displayed to the left of the iOS device name.

① **About the transceiver's display**

After the connection has succeeded, the transceiver displays " * * * Connected." and the Bluetooth icon is displayed. (" * * *" is the Bluetooth name of the iOS device.)

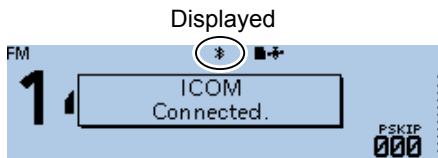

On the PAIRING/CONNECT screen, "📶" is displayed to the left of the iOS device name. (Bluetooth Set > **Pairing/Connect**)

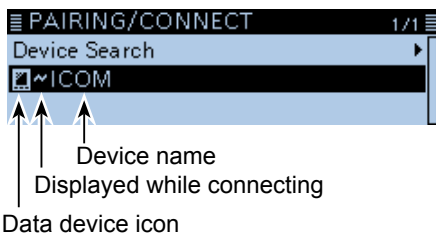

NOTE: If you cannot connect, check that the same CI-V address is set between the transceiver and the RS-MS1I.

You can see the CI-V setting as described below:

Transceiver

"CI-V Address" in the Menu screen.

(Function > CI-V > **CI-V Address**) (Default: 9A)

RS-MS1I:

"Application Setting" → "CI-V address" (Default: Transceiver[9A])

Disconnecting from a Bluetooth® device

There are 3 ways to disconnect from a Bluetooth device (headset device or data device).

- Turn OFF a headset
- Turn OFF the Bluetooth on a data device
- ① See the instruction manual of the headset or a data device for details.

Or, you can disconnect from a Bluetooth device without canceling the pairing, as described below.

Bluetooth Set > Pairing/Connect

1. Push [MENU].
2. Rotate [DIAL] to select “Bluetooth Set,” then push [↵].

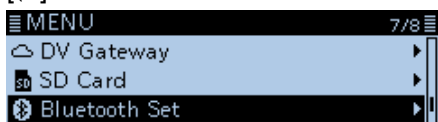

3. Select “Pairing/Connect,” then push [↵].

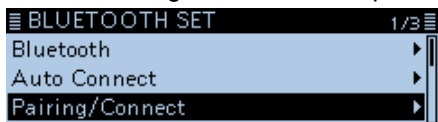

4. Select the Bluetooth device, then push [↵].

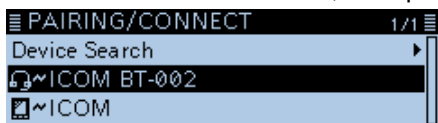

• The confirmation dialog “Disconnect?” is displayed.

5. Select <YES>, then push [↵].

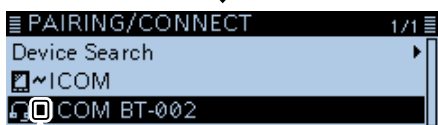
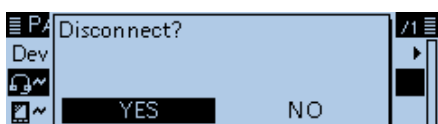

↑
“ICOM BT-002” disappears

• The transceiver disconnects from the Bluetooth device, and “ICOM BT-002” disappears from the list. However, the transceiver is still paired with the device.

- ① When you select the unconnected device displayed in the pairing list, the transceiver displays “Connect?.” To connect to the device, select <YES>.

Deleting a Bluetooth® device from the pairing list

You can delete a Bluetooth device from the pairing list. Before deleting a connected Bluetooth device, disconnect it.

Bluetooth Set > Pairing/Connect

1. Push [MENU].
2. Rotate [DIAL] to select “Bluetooth Set,” then push [↵].



3. Select “Pairing/Connect,” then push [↵].

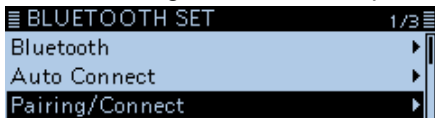

4. Select the Bluetooth device, then push [QUICK].



5. Select “Delete,” then push [↵].

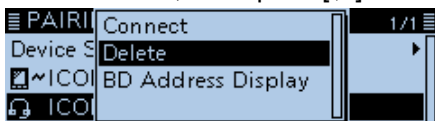

- The confirmation dialog “Delete?” is displayed.

6. Select <YES>, then push [↵].

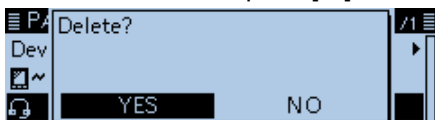

- Deletes the selected device from the pairing list.

TIP: To connect to the deleted device again, you must first pair with it again.

- Pairing with a headset: p. 12-3
- Pairing with an Android device: p. 12-10
- Pairing with an iOS device: p. 12-12

Editing the installed Bluetooth® unit name

You can edit the Bluetooth unit name. After initializing the unit, the edited name remains.

Bluetooth Set > Bluetooth Device Information

1. Push [MENU].
2. Rotate [DIAL] to select “Bluetooth Set,” then push [↵].



3. Select “Bluetooth Device Information,” then push [↵].

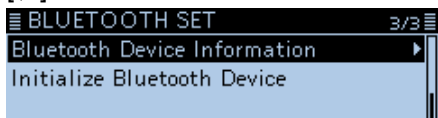

- Displays the BLUETOOTH DEVICE INFO screen.

4. Push [QUICK].
5. Select “Edit Name,” then push [↵].

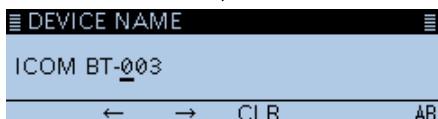
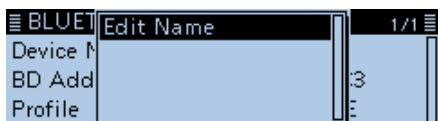

- Enters the unit name entry mode.

6. Enter a name of up to 8 characters*. (Example: ICOM BT-003 A)

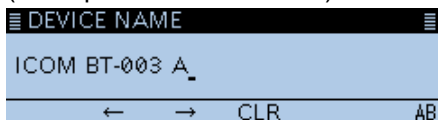

Selectable characters and symbols
A to Z, a to z, 0 to 9, ! " # \$ % & ' () * + , - . / : ; < = > ? @ [\] ^ _ ` { } ~ (space)

① See “Entering and editing text” for details. (p. iv)
 *Except for “ICOM BT-.”

7. After entering, push [↵].
 - Sets the edited name.

Initializing the installed Bluetooth® unit

You can initialize the installed UT-137 Bluetooth® UNIT. You should initialize the unit if you have trouble during Bluetooth operation.

When you do a partial reset or all reset, the Bluetooth settings returns to their factory defaults. However, the device name and pairing/connection information remain.

Bluetooth Set > Initialize Bluetooth Device

1. Push [MENU].
2. Rotate [DIAL] to select “Bluetooth Set,” then push [↵].

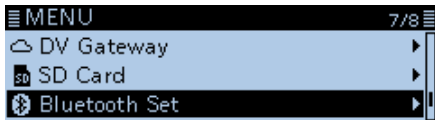

3. Select “Initialize Bluetooth Device,” then push [↵].



- The confirmation dialog “Initialize Bluetooth Device?” is displayed.

4. Select <YES>, then push [↵].

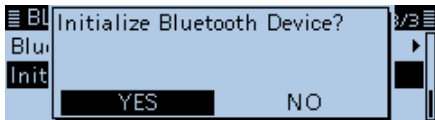

- Resets the installed UT-137's settings to their factory defaults, and returns to the standby display.

The maximum number of paired devices

You can pair 3 types of the Bluetooth devices:
Headset, Data device, and Low Energy device.

Up to 7 Bluetooth devices can be paired with the UT-137. However, you cannot pair with 7 headsets only, 7 data devices only, or 7 Low Energy devices only.*

* Either headsets or Android devices are maximum 4 devices, and the combination is 5 devices in total.

* Bluetooth Low Energy devices are maximum 2 devices.

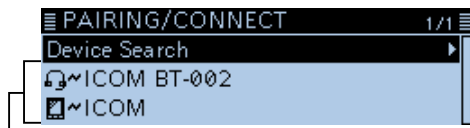

▶ Displays the paired Bluetooth device

Section 13 UPDATING THE FIRMWARE

General.....	13-2
◇ About updating the firmware.....	13-2
◇ Cautions.....	13-2
◇ Item requirement.....	13-2
◇ Checking the firmware version	13-2
Updating the firmware	13-3

General

◇ About updating the firmware

You can update the ID-4100A/E's firmware using a microSD card. Updating the firmware can add new functions or improve performance parameters.

You can download the latest firmware from the Icom website.

<http://www.icom.co.jp/world/index.html>

◇ Cautions

- **CAUTION: NEVER** turn OFF the transceiver while updating the firmware. If you turn OFF the transceiver, or if a power failure occurs while updating, the transceiver firmware may be damaged and you may have to send the transceiver back to the nearest Icom distributor for repair. This type of repair is out of warranty, even if the transceiver warranty period is still valid.
- We recommend that you backup all the transceiver's data to a microSD card or to a PC before starting the firmware update. Settings and/or memory contents may be lost or returned to their default settings when the firmware is updated.
- You are responsible for the the results after updating the firmware.

◇ Item requirement

- PC
- microSD card
- microSD card slot or a memory card reader

NOTE: Before using a microSD card, format it with the transceiver.

- ① Formatting a card erases all its data. Before formatting any used card, back up its data onto your PC.
- ① See the Basic manual for details.

◇ Checking the firmware version

You can check the firmware version on the MENU screen.

Others > Information > Version

1. Push [MENU].
2. Rotate [DIAL] to select "Others," then push [↵].



3. Select "Information," then push [↵].



4. Select "Version," then push [↵].

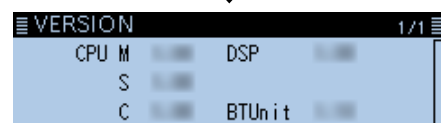
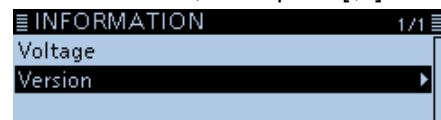

- The firmware version is displayed.

Updating the firmware

These instructions are based on Microsoft® Windows® 10.

Step 1. Downloading the firmware file

1. Access the following URL.
http://www.icom.co.jp/world/index.html
2. Click **<Support>**.

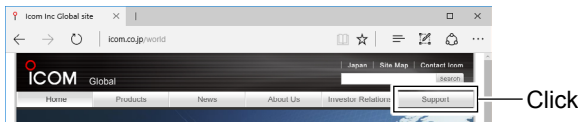

3. Click the **“Firmware Updates/Software Downloads”** link.



4. Click the firmware file link in the ID-4100A/E group.
5. Read “Regarding this Download Service” carefully, and then click **<Agree>**.

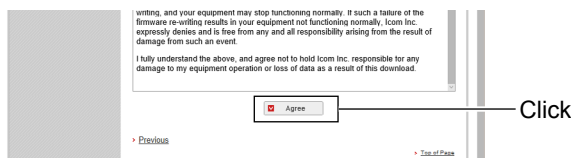

6. Click **<Save as>**.



7. Select the location where you want to save the firmware, and then click **<Save>**.
(Example: Desktop)

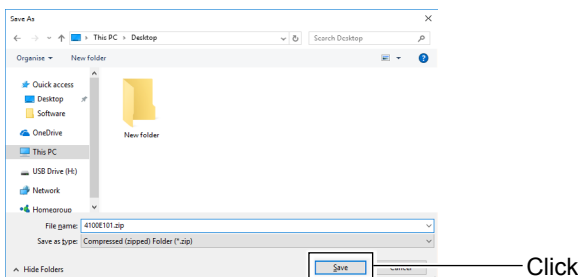

- The file starts downloading.
- ① The firmware and the firm utility are compressed in a “zip” format folder.

8. Right-click the downloaded firmware folder (zip format).
9. Click “Extract All...”

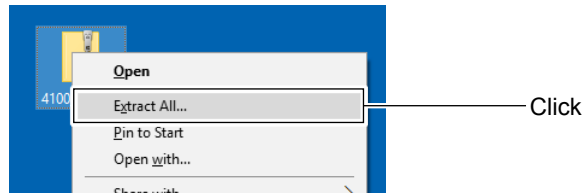

10. Select the location where you want to create the unzipped folder, then click **<Extract>**.
(Example: Desktop)

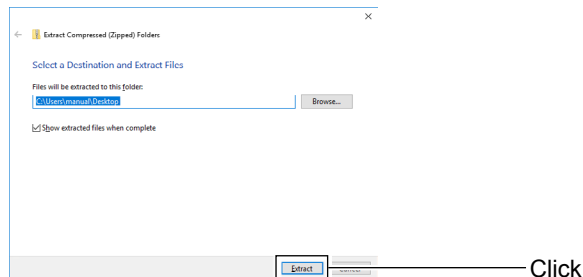

- After unzipping, a folder is created in the specified location.
- ① In the “4100E_***” folder, “4100E_***.dat” is created.
- * “***” represents the release number.

Step 2: Inserting the microSD card into a PC

NOTE: To use the microSD card with the transceiver, format the card, even preformatted microSD cards for PCs or other uses. See Basic manual section 7 for details.

1. Turn OFF the transceiver, then remove the microSD card.
2. Insert it into the microSD card drive or a memory card reader* on your PC.
*User supplied.

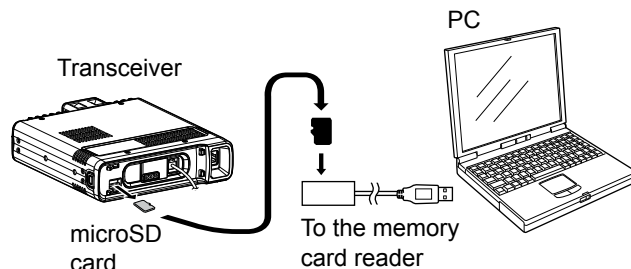

Continued on the next page.

Updating the firmware (Continued)

Step 3. Copy the downloaded firmware data

1. Double-click the created folder.
(Example: 4100E101).
2. Copy the downloaded firmware data into the ID-4100 folder on a microSD card.
(Example: 4100E101.dat).

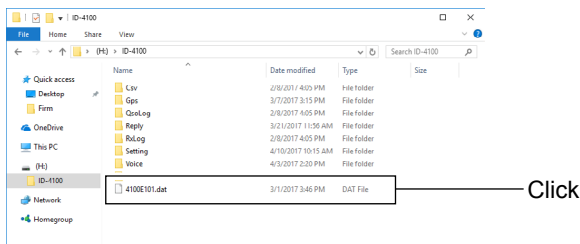

Step 4: Removing the microSD card

Turn OFF the transceiver, then remove the microSD card from your PC, and insert it into the transceiver's slot.

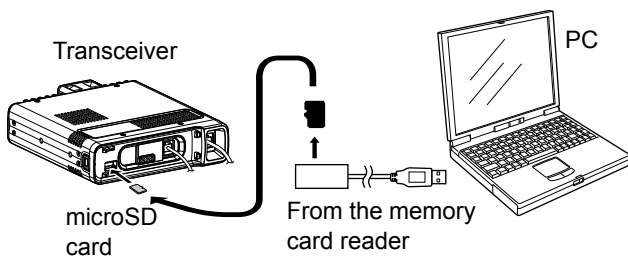

Step 5: Updating the firmware

CAUTION: NEVER turn OFF the transceiver while updating the firmware.

If you turn OFF the transceiver, or if a power failure occurs while updating, the transceiver firmware may be damaged and you may have to send the transceiver back to the nearest Icom distributor for repair. This type of repair is out of warranty, even if the transceiver warranty period is still valid.

SD Card > Firmware Update

1. Push [MENU].
2. Rotate [DIAL] to select "SD Card," then push [↵].

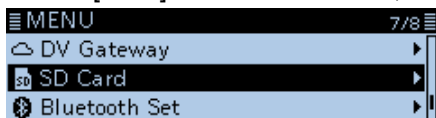

3. Select "Firmware Update," then push [↵].

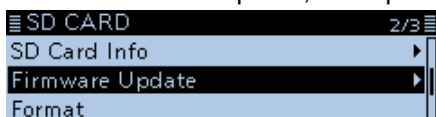

- The firmware update agreement screen is displayed.

4. Carefully read all the displayed precautions. After you read and agree with all the precautions, select <YES>, then push [↵].

Firmware updating has risks, and you do so at your own risk and responsibility. If you make a mistake updating, the

ID-4100 may not work properly or the data will become corrupted. In that case you must send it to an Icom distributor for repair.

Refer to the instruction manual for the correct updating procedures. Depending on the updating version, all previous settings and memory

contents may be lost. Before updating, make a backup file of the settings and memory contents onto an SD Card.

Do you agree to all of the above?

YES NO

- ① Rotate [DIAL] to scroll the screen.
- ① To cancel the updating, select <NO>.

5. Select the Firmware, then push [↵].
(Example: 4100E101).



- The final confirmation screen is displayed.

Continued on the next page.

Updating the firmware (Continued)

- Carefully read all the displayed precautions. After you read and agree with all them, select <YES>, then push [↵].

Firmware updating takes approximately 4 minutes. After updating, the ID-4100 will automatically restart.

Until the frequency screen is displayed, NEVER turn OFF the ID-4100 or remove the SD Card.

Do you want to start updating?

YES NO

- The updating starts.

ⓘ Information

- To cancel the updating, select <NO>.
 - The transceiver reads the firmware file from the microSD card and writes it to the main CPU, sub CPU, DSP, and the controller CPU.
 - Downloading and loading status are displayed in the dialogs.
- The firmware updating has completed, the transceiver will automatically restart. And then, returns to the standby screen.

TIP:

- To check the firmware version after the updating, see "Checking the firmware version" for details. (p. 13-2)
- To delete the firmware file on the microSD card, push [QUICK], then select "Delete" on the FIRMWARE UPDATE screen.

INDEX

Number	C	
1750 Hz tone burst8-3		
A		
Access Point Mode.....9-67	Call CH9-17	
Active band.....9-60	Selecting1-4	
AF Output.....9-69	Call Sign9-41, 4-31	
Alarm	Received call signs4-19	
Alarm Area (Group).....9-39	My Call Sign.....9-47	
Alarm Area (RX/Memory).....9-39	Your (destination) call sign	
Alarm Select.....9-39	Deleting4-44	
All Reset9-73, 10-18	Entering4-43	
Alphabet9-51	CI-V10-19	
Altitude.....9-27	CI-V Address.....9-60	
Attenuator function10-3	CI-V Baud Rate.....9-60	
Auto Connect.....9-69	CI-V Bluetooth→REMOTE Transceive Address.9-61	
Auto Dimmer	CI-V information10-19	
Auto Dimmer9-62	CI-V Transceive9-61	
Auto Dimmer Cancel (DV RX)9-62	Cloning function.....10-14	
Auto Dimmer Cancel (PTT).....9-62	Clone Mode.....9-73	
Auto Dimmer Timer9-62	Comment.....9-26, 9-28, 9-31, 9-34	
Auto Power OFF.....9-67	Course.....9-29, 9-32	
Auto Repeater9-57, 8-5	Custom Key.....9-71	
Auto Reply.....9-48	Custom Key Beep.....9-70	
Automatic DV detection4-23		
Automatic Reply function.....4-24	D	
Auto Position Reply function4-26	Data Extension9-27, 9-29, 9-32	
Recording an Auto Reply message.....4-25	Data Speed.....9-60	
B		Data Type9-28, 9-31
Band Edge Beep9-66	Date9-54, 9-67, 9-68	
Band Scope function10-4	DIAL SPEECH.....9-51	
Sweep operation10-4	Dial Speed-UP.....9-57	
Bank Link.....9-18	Digital Code.....9-16	
Barometric9-64	Digital Monitor.....9-49	
Beep Level.....9-66	Digital Repeater Set9-49	
BK9-50	Directivity9-27, 9-30, 9-33	
BK mode communication4-21	Display Language.....9-64	
Bluetooth9-69, 12-1	Display Unit	
Connecting.....12-3, 12-10, 12-12	Altitude/Distance9-64	
Deleting.....12-15	Barometric.....9-64	
Disconnecting12-14	Latitude/Longitude9-64	
Initializing9-72, 12-17	Rainfall9-64	
Pairing.....9-69	Speed.....9-64	
RS-MS1A.....12-8	Temperature.....9-64	
RS-MS1I12-9	Wind Speed9-64	
Setting.....9-69	DR scan.....4-5	
VOX function.....9-70, 12-4	Skip setting4-40	
Bluetooth Device Information9-72	D-STAR operation4-1	
Brightness.....9-62	Data communication4-27	
Busy Lockout.....9-60	DV Fast Data function.....4-28	
	Digital squelch functions4-29	
	EMR.....4-22, 9-50	
	“FROM” (Access repeater) setting4-3	
	Message operation4-17	
	Repeater list.....4-32	
	“TO” (Destination) setting.....4-8	

INDEX

D (Continued)

DTCS
DTCS Code.....9-16
DTCS Polarity9-16
DTCS squelch operation.....10-12
DTMF Memory.....9-53, 10-8
DTMF code10-8
DTMF Speed.....9-53, 10-10
Transmitting10-9
Duplex operation8-4
Duplex direction8-4
Frequency offset8-4
DV Auto Detect.....9-49
DV Auto Reply9-22
DV Data TX9-48
DV Gateway
Access Point Mode9-67
Terminal Mode9-67

E

EMR4-22, 9-50
EMR AF Level.....9-50
Export.....9-68

F

Fan Control.....9-57
Fast Data9-49
File Split.....9-21
Firmware Update.....9-68
Firmware version13-2
FM Repeater operation.....8-2
Format9-68

G

Gain9-27, 9-30, 9-33
GPS Auto TX5-38, 9-40
GPS Data Speed9-49
GPS Information (Sky view screen).....5-11, 9-36
GPS Logger.....9-40
GPS Memory5-27, 9-38
Adding.....5-27
Changing.....5-9
Deleting.....5-30
GPS alarm5-32
Group name, Entering.....5-30
GPS Message9-35
GPS Logger function5-34
GPS record interval.....5-34, 9-40
GPS record sentence.....5-35, 9-40
Viewing the log data on a PC Map.....5-36

GPS operation.....5-1
Compass Direction.....5-10
Grid Locator5-9
D-PRS data.....5-13
Item5-7, 5-17
Object5-7, 5-17
Position (Base)5-6, 5-15
Position (Mobile).....5-6, 5-15
Weather5-8, 5-21
NMEA data.....5-25
NMEA5-8
GPS message5-26
GPS data sentence5-25
GPS Out (To DATA jack).....9-24
GPS Position9-36
Displaying5-3
Receiving5-2
Saving5-10
GPS Select.....9-24
GPS Sentence.....9-35
GPS Time Correct9-67
GPS TX Mode9-24

H

Headset Function Select9-69, 12-6
AF Output.....12-6
Height9-27, 9-30, 9-33
Home channel function.....10-7
Home CH Beep.....9-66, 10-7
Operation10-7
Setting.....10-7

I

Import9-68
Initialize Bluetooth Device9-72
Item Name9-31

K

Key Backlight Brightness.....9-62
Key Backlight Color9-62
Key-Touch Beep9-66

L

Latitude/Longitude9-64
LCD Backlight Brightness.....9-62
LCD Backlight Color9-62
LCD Contrast.....9-63
Load Setting9-68

INDEX

M	P
Manage Memory screen.....	1-3
Memory Bank	1-8
Assigning a memory channel	1-8
Bank name, Entering	1-11
Selecting the Memory Bank mode	1-9
Writing.....	1-9
Memory CH	9-17
Clearing.....	1-12
Content	1-2
Copying.....	1-6, 1-7
Selecting	1-4
Writing.....	1-5
Overwriting.....	1-6
Memory name	
Entering.....	1-10
Memory name display	1-12
MENU screen	9-1
Menu items and Default settings.....	9-3
Operation	9-2
Selecting a Menu item	9-2
Message operation.....	4-17
Deleting.....	4-18
Entering.....	4-17
Transmitting	4-17
MIC Gain	9-60, 10-3
microSD card.....	6-1
Backup.....	6-6, 6-7
Exporting a CSV format file.....	6-9
Importing a CSV format file.....	6-8
Loading	6-5
Saving.....	6-2, 6-3, 6-4, 9-68
MODE SPEECH.....	9-51
My Call Sign	9-47
N	
Near Repeater Search function.....	4-6
Night Time operation	
Night Time End	9-62
Night Time Setting.....	9-62
Night Time Start	9-62
O	
Object Name.....	9-28
Off band indication.....	8-5
Offset frequency	9-16
One-Touch PTT	9-70
One-Touch PTT (Remote MIC).....	9-60
Opening Message	9-64
Options	11-2
Paring	
Paring/Connect	9-69
Paring Reception	9-69
Partial Reset.....	9-73, 10-18
Pause Timer	9-18
Play Files	9-21
Position.....	9-29, 9-32
Manual Position	9-24
Power	9-27, 9-30, 9-33
Power OFF (With No Controller)	9-61
Power Save	9-70
Priority watch	3-1
Canceling	3-2
Starting.....	3-2
Program Link	9-19
Program Scan Edge	9-18
Program Skip.....	9-18
PTT Auto REC	9-22
PTT Beep	9-70
PTT Lock	9-60
Q	
QSO Log.....	9-54
R	
Rainfall.....	9-64
REC Mode	9-21
Record	9-23
Record Interval	9-40
Record Sentence.....	9-40
REC Start	9-21
Reflector	
Linking.....	4-14
Reflector Echo Testing	4-15
Requesting repeater information.....	4-16
Unlinking	4-15
Using.....	4-13
Remote control (CI-V) information.....	10-19
Remote MIC Key	9-57
Repeater detail screen	4-42
Repeater List	4-32, 9-45
Adding.....	4-39
Deleting.....	4-37
Editing	4-37
Entering.....	4-33
Repeater Tone	9-16
Repeat Time	9-23
Reply Position Display.....	9-63
Resetting	10-18
All Reset.....	9-73, 10-18
Partial Reset	9-73, 10-18
Resume Timer	9-18

INDEX

R (Continued)

RF meter..... 10-2
RS-MS1A..... 12-8
RS-MS1I..... 12-9
RX Bass..... 9-48
RX Bass Boost 9-48
RX Call Sign 9-63
RX Call Sign SPEECH 9-51
RX>CS SPEECH..... 9-51
RX History 9-42
RX History Log 9-54
RX Position Display..... 9-63
RX Position Display Timer 9-63
RX Position Indicator..... 9-63
RX REC Condition..... 9-21
RX Record (RPT) 9-49
RX Treble..... 9-48

S

Save Setting 9-68
Scan 2-1
 Bank Link 9-18
 [DIAL] operation 2-3
 Duplex (DUP) scan 2-2
 Memory Bank scan 2-7
 Memory scan 2-6
 Pause Timer 9-18
 Receive mode during a scan 2-3
 Resume Timer..... 9-18
 Scan edges, Entering..... 2-9
 Scan Stop Beep 2-3, 9-66
Skip
 Skip channel..... 2-8
 Skip frequency..... 2-5
 Temporary Skip timer 2-3, 9-18
Squelch setting 2-3
Tone scan..... 2-2
Tuning step for a VFO scan 2-3
VFO mode scan 2-4
Scope AF Output 9-66
Scroll Speed 9-63
SD Card Info..... 9-68
Separator/Decimal..... 9-54, 9-68
Serialport Function 9-72
Skip Time..... 9-22
Speech
 SPEECH Language 9-51
 SPEECH Level..... 9-52
 SPEECH Speed..... 9-52
Speed 9-29, 9-32, 9-64
Squelch/ATT Select..... 9-57
Squelch Delay 9-57, 10-2
SSID 9-26, 9-30, 9-33, 9-34

Standby Beep..... 9-66
Symbol..... 9-24, 9-28, 9-31, 9-34
Symbol list 9-25
System Language..... 9-64

T

Temperature 9-64
Temporary Skip Timer..... 9-18
Terminal Mode 9-67
Text entry iv
TIME 9-67
Time-Out Timer..... 9-60
Time Stamp 9-26, 9-30, 9-34
Tone Burst 9-16
Tone squelch operation 10-11
Transmit power levels..... 10-2
TSQL Freq 9-16
TX 9-23
TX Bass 9-48
TX Call Sign..... 9-63
TX Delay (PTT)..... 9-49
TX Format..... 9-24
TX History..... 4-7
TX Message 9-47
TX Monitor 9-23
TX Treble 9-48

U

Unmount..... 9-68
Unproto Address..... 9-24
Updating the firmware 13-1
 Firmware version 13-2
Up/Down MIC Key 9-57
UTC Offset..... 9-67

V

Version..... 9-73
Voice memory..... 7-1
 Changing the QSO recorder settings 7-4
 Deleting an Audio File 7-5
 Deleting an Audio Folder..... 7-5
 File information 7-6
 Memory capacity (microSD card)..... 7-7
 Play Files 9-21
 Playing back..... 7-3
 On the PC..... 7-8
Recording..... 7-2
REC Mode 9-21
REC Start..... 9-21

INDEX

V (Continued)

Voice TX function..... 10-5
 Changing the voice TX settings 10-6
 Recording..... 10-5
 Transmitting 10-6
 Record 9-23
 Repeat Time..... 9-23
Voltage..... 9-73
Voltage (Power ON)..... 9-64

VOX

VOX function 9-70, 12-4
VOX Delay 9-70, 12-5
VOX Level..... 9-70, 12-4
VOX Time-Out Timer..... 9-70, 12-5

W

Weather channel operation 10-13
 Weather alert function 10-13
Weather station transmission 5-23
Wind Speed 9-64

Y

Your Call Sign..... 9-45

Count on us!

