



FULL MANUAL

DUAL BAND TRANSCEIVER

ID-5100A ID-5100E

To update the repeater list,
click [here!](#)

INTRODUCTION

1 PANEL DESCRIPTION

2 BASIC OPERATION

3 MEMORY OPERATION

4 SCAN OPERATION

5 PRIORITY WATCH

6 D-STAR OPERATION <BASIC>

7 D-STAR OPERATION <ADVANCED>

8 GPS OPERATION

9 USING AN SD CARD

10 VOICE MEMORY

11 REPEATER AND DUPLEX OPERATIONS

12 MENU SCREEN

13 OTHER FUNCTIONS

14 OPTIONS

15 Bluetooth® OPERATION

16 SPECIFICATIONS

17 MAINTENANCE

INDEX

INTRODUCTION

FOREWORD

Thank you for purchasing this fine Icom product. The ID-5100A and ID-5100E DUAL BAND TRANSCEIVER are designed and build with Icom's superior technology and craftsmanship combining traditional analog technologies with the new digital technology, Digital Smart Technologies for Amateur Radio (D-STAR), for a balanced package.

With proper care, this product should provide you with years of trouble-free operation.

We thank you for making your ID-5100A or ID-5100E your transceiver of choice, and hope you agree with Icom's philosophy of "technology first." Many hours of research and development went into the design of your ID-5100A or ID-5100E.

EXPLICIT DEFINITIONS

WORD	DEFINITION
⚠ DANGER!	Personal death, serious injury or an explosion may occur.
⚠ WARNING!	Personal injury, fire hazard or electric shock may occur.
CAUTION	Equipment damage may occur.
NOTE	Recommended for optimum use. No risk of personal injury, fire or electric shock.

IMPORTANT

READ ALL INSTRUCTIONS carefully and completely before using the transceiver.

SAVE THIS INSTRUCTION MANUAL— This instruction manual contains full operating instructions for the ID-5100A/ID-5100E.

Icom, Icom Inc. and the Icom logo are registered trademarks of Icom Incorporated (Japan) in Japan, the United States, the United Kingdom, Germany, France, Spain, Russia and/or other countries.

Adobe and Adobe Reader are either registered trademarks or trademarks of Adobe Systems Incorporated, in the United States and/or other countries.

Microsoft, Windows and Windows Vista are registered trademarks of Microsoft Corporation in the United States and/or other countries.

The Bluetooth® work mark and logos are registered trademarks owned by Bluetooth SIG, Inc. and any use of such marks by Icom inc. is under license.

All other products or brands are registered trademarks or trademarks of their respective holders.

SUPPLIED ACCESSORIES

The following accessories are supplied with the transceiver.

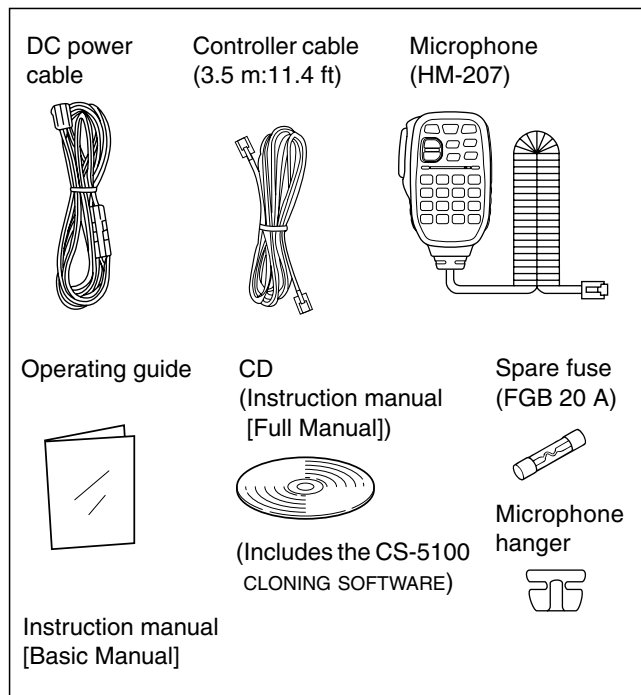

INTRODUCTION

ABOUT THE SUPPLIED CD

The following instructions and installers are included on the CD.

- **Basic Manual**
Basic operating instructions
- **Full Manual**
Full operating instructions, and are the same instructions that are in this manual
- **Cloning Software Installer**
Installer for the CS-5100 cloning software
- **Cloning Software Instruction manual**
Instructions for the CS-5100 cloning software installation and use
- **Operating Guide**
Operating guide for using the touch screen, Menu items and Quick menu items. Contains the same information that is in the supplied leaflet.
- **HAM radio Terms**
A glossary of HAM radio terms
- **Adobe® Reader® Installer**
Installer for Adobe® Reader®

A PC with the following Operating System is required.

- Microsoft® Windows® 8.1, Microsoft® Windows® 8, Microsoft® Windows® 7, Microsoft® Windows Vista® or Microsoft® Windows® XP

◇ Starting the CD

- ① Insert the CD into the CD drive.
 - Double click "Menu.exe" on the CD.
 - Depending on the PC setting, the Menu screen shown below is automatically displayed.
- ② Click the desired button to open the file.
 - To close the Menu screen, click [Quit].

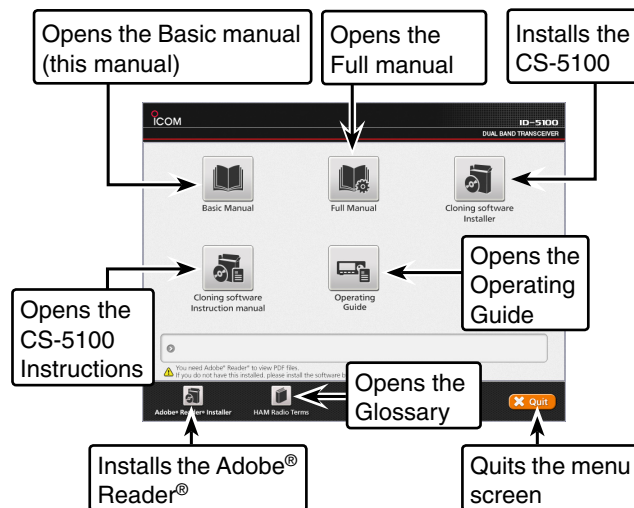

To read the guide or instructions, Adobe® Reader® is required. If you have not installed it, please install the Adobe® Reader® on the CD or downloaded it from Adobe Systems Incorporated's website.

INTRODUCTION

ABOUT THE TOUCH SCREEN

◇ Touch screen precautions

Briefly touching the controller's touch operates the function.

- The touch screen may not properly work when LCD protection film or sheet is attached.
- Touching the screen with finger nails, sharp topped object and so on, or touching the screen hard may damage the screen.
- Tablet PC's operations such as flick input, pinch in and pinch out cannot be performed with this touch screen (based on the resistance film type).

◇ Touch screen maintenance

- If the touch screen becomes dusty or dirty, wipe it clean with a soft, dry cloth.
- When you wipe the touch screen, be careful not to push it too hard or scratch it with finger nails. Otherwise you may damage the touch screen.

◇ Touch operation

Ⓢ (Short touch): If the display is touched briefly, one short beep sounds.

Ⓛ (Long touch): If the display is touched for 1 second, one short and one long beep sound.

- After the beep, the operation is enabled.

▨ In the instruction manual, the touch operation is described as shown below.

Ⓢ If the display is touched briefly, one short beep sounds.

Ⓛ If the display is touched for 1 second, one short and one long beep sound.

◇ About the Touch area

Areas you can touch for various operations are shown below.

- This page describes the main operations of the touch screen. See the appropriate pages for other operations.

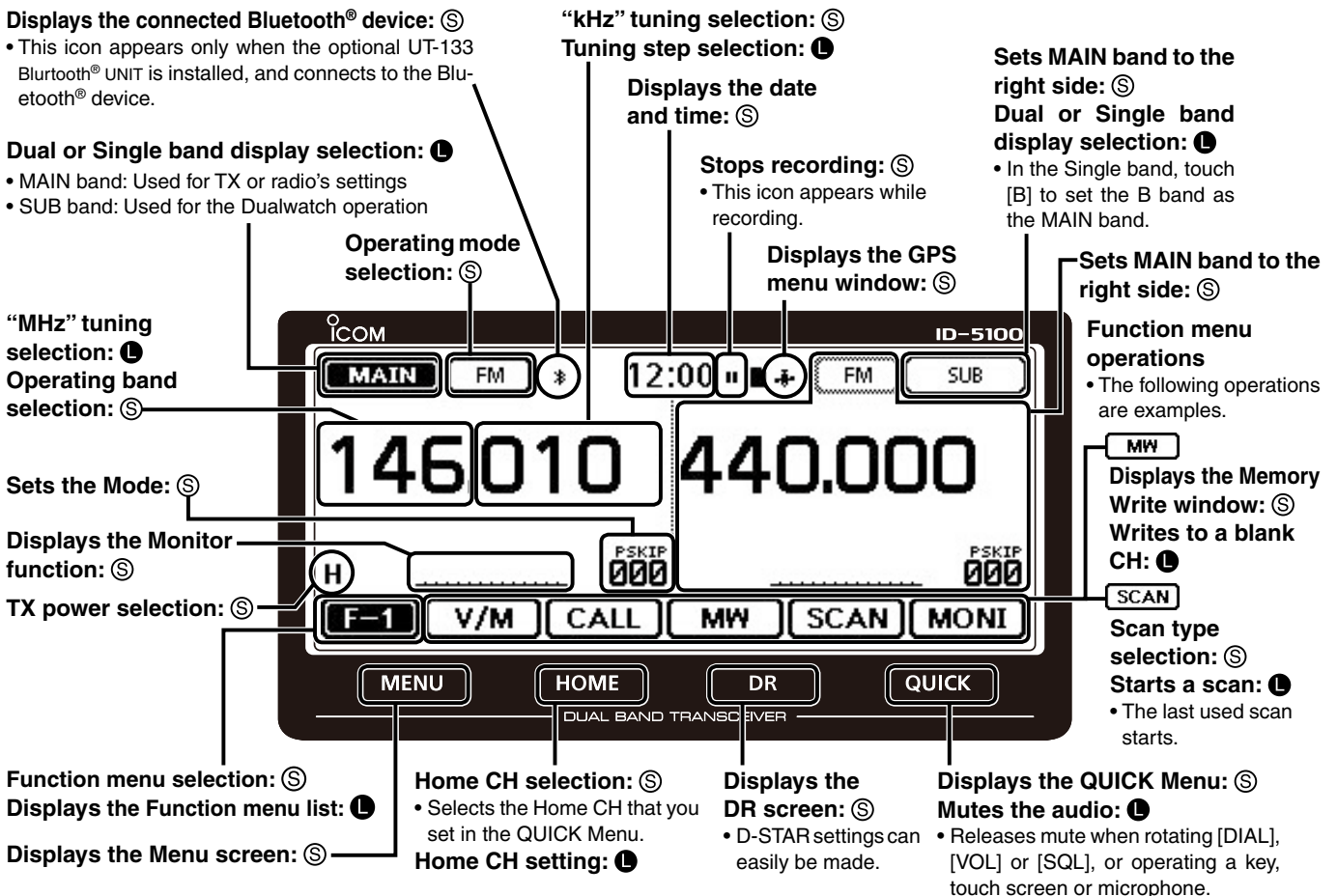

INTRODUCTION

Functions and features of Adobe® Reader®

The following functions and features can be used with Adobe® Reader®.

• Keyword search

Click “Find (Ctrl+F)” or “Advanced Search (Shift+Ctrl+F)” in the Edit menu to open the search screen. This is convenient when searching for a particular word or phrase in this manual.

*The menu screen may differ, depending on the Adobe® Reader® version.

Click to open the find or search screen or advanced search screen.

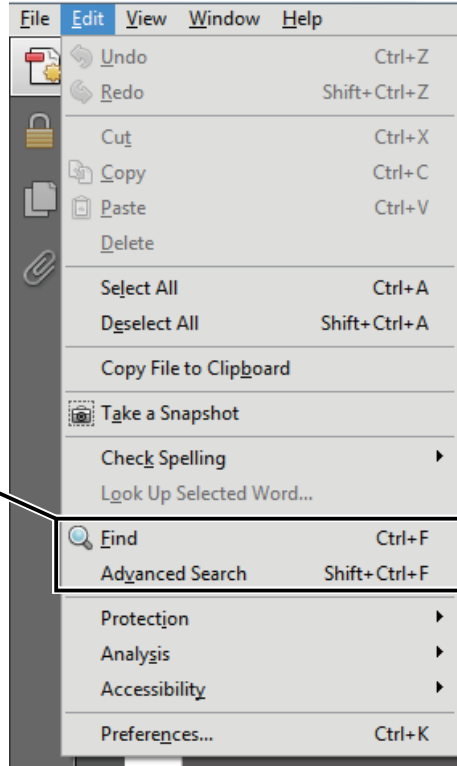

• Find screen

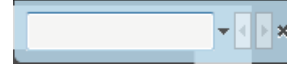

• Advanced search screen

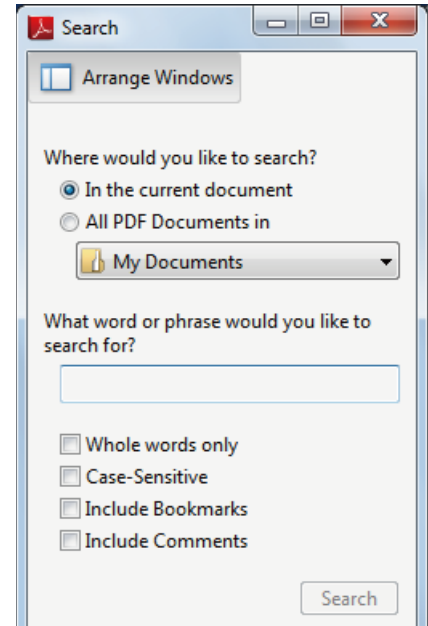

• Printing out the desired pages.

Click “Print (P)” in File menu, and then select the paper size and page numbers you want to print.

*The printing setup may differ, depending on the printer. Refer to your printer’s instruction manual for details.

*Select "A4" size to print out the page in the equal-sized size.

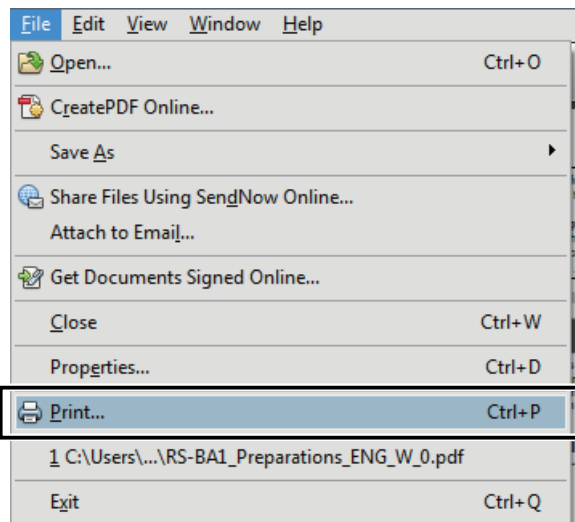

• Read Out Loud feature.

The Read Out Loud feature reads aloud the text in this Instruction Manual.

Refer to the Adobe® Reader® Help for the details. (This feature may not be usable, depending on your PC environment including the operating system.)

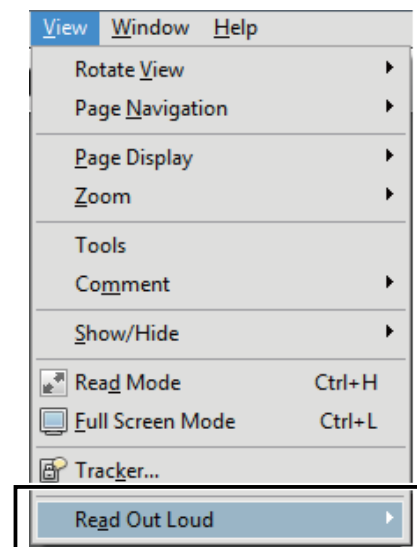

*The screen may differ, depending on the Adobe® Reader® version.

INTRODUCTION

About these Advanced Instructions (PDF format)

These Advanced Instructions describe the details of the ID-5100A/E features. This PDF formatted manual provides you with convenient functions, as follows.

NOTE: Below page is used only as an example to describe these advanced instructions.

Move to the previously read page.

Click **Previous view** at the left top on an each page, to move back to the previously read page.



Moves to the page, if clicked.

(p. 12-58)

2 BASIC OPERATION

Power ON and setting audio volume/squelch level

◇ **Turning ON the power**

- Hold down [⏻] for 1 second to turn ON the power.
 - A beep sounds and, after the opening message and power source voltage are displayed, the operating frequency appears.
 - Hold down [⏻] for 1 second to turn OFF the power.

(Sample)

You can select the opening message display option in the Menu screen (p. 12-58)
Display > **Opening Message**

You can select the power source voltage display option in the Menu screen (p. 12-58)
Display > **Voltage (Power ON)**

◇ **Setting audio volume and squelch level**

- Rotate [VOL] to adjust the audio level.
 - The beep level is adjusted in the "Beep Level" item of the Menu screen. (p. 12-61)
Sounds > **Beep Level**
- Rotate [SQL] until the noise and the "BUSY" icon just disappear.
 - Rotating [SQL] clockwise makes the squelch tight. The tight squelch is for strong signals.
 - When rotating [SQL] clockwise beyond the center position, [SQL] can be used as 'S-meter Squelch' or 'Attenuator.' Select the [SQL] option in the Menu screen. (p. 12-52)

▶ To mute the audio, touch [QUICK] for 1 second.

- Releases mute when rotating [DIAL], [VOL] or [SQL], or operating a key, touch screen or microphone.

2-2

Icom, Icom Inc. and the Icom logo are registered trademarks of Icom Incorporated (Japan) in Japan, the United States, the United Kingdom, Germany, France, Spain, Russia and/or other countries.

Adobe and Adobe Reader are registered trademark of Adobe Systems Incorporated.

All other products or brands are registered trademarks or trademarks of their respective holders.

Section 1 **PANEL DESCRIPTION**

Controller — Front panel	1-2
Controller — Display (Touch screen).....	1-3
◇ Function menu.....	1-5
Main unit — Front and rear panels	1-7
◇ Microphone connector information	1-7
Microphone (HM-207)	1-8
◇ Setting frequency and Memory channel.....	1-9

Controller — Front panel

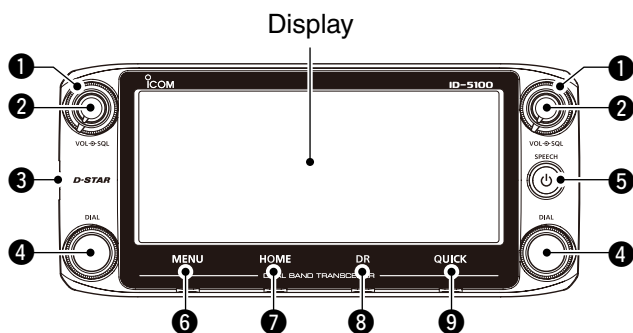

About control's operation

In the Dualwatch mode, the left side controls are used for the left side band, and the right side controls are used for the right side.

In the Single watch mode, the left side controls are used for the A band, and the right side controls are used for the B band.

1 SQUELCH CONTROL [SQL]

Rotate to adjust the squelch level. (p. 2-2, p.4-3)

- Normally, set the squelch level to where noise and the "BUSY" icon just disappear. (closed)
- You can use the S-Meter Squelch or Attenuator function by rotating the control clockwise beyond the center position. (p. 2-13)

2 VOLUME CONTROL [VOL]

Rotate to adjust the audio level. (p. 2-2)

3 MAIN UNIT CONNECTOR

Connect the controller to the Main unit using the supplied control cable. (p. 1-7)

4 TUNING DIAL [DIAL]

- ➔ In the VFO mode, rotate to select the operating frequency, and in the Memory mode, rotate to select a Memory channel. (p. 3-4)
- ➔ In the Menu screen or Quick Menu window, rotate to select a desired option or value. (p. 12-2)
- ➔ While scanning, rotate to change the scanning direction. (p. 4-3)

5 POWER KEY [PWR]

- ➔ Hold down for 1 second to turn power ON or OFF. (p. 2-17)
- ➔ Push to audibly announce the operating frequency, mode or a selected call sign. (p. 2-2)

6 [MENU] (Touch screen) (p. 12-2)

Touch to open the Menu screen.

7 [HOME] (Touch screen) (p.2-16)

- ➔ Touch to select the Home channel.
- ➔ Touch for 1 second to set the Home channel.

8 [DR] (Touch screen) (p. 2-10)

Touch to open the DR screen.

9 [QUICK] (Touch screen)

- ➔ Touch to open the Quick Menu window.
- ➔ Touch for 1 second to mute the audio.

Controller — Display (Touch screen)

Dualwatch mode

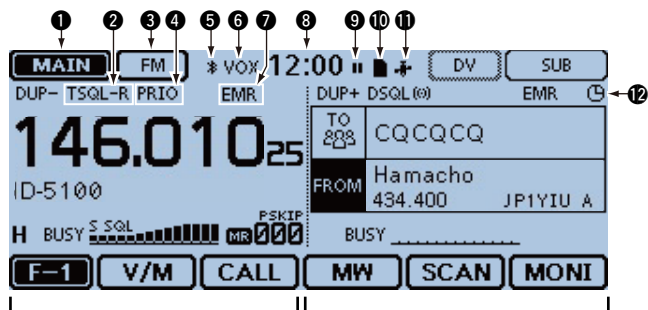

This side becomes the A band in the Single watch mode This side becomes the B band in the Single watch mode

Single watch mode (A band)

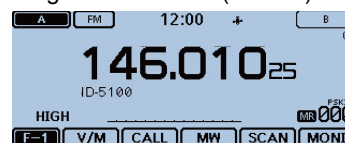

Single watch mode (B band)

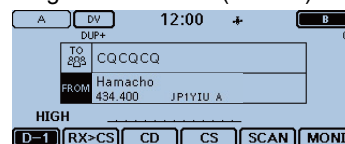

1 MAIN/SUB BAND ICON (p. 2-3)

In the Dualwatch mode, this icon will be highlighted to indicate the MAIN band.

“SUB” is displayed on the SUB band.

2 TONE/DIGITAL SQUELCH ICONS

Displayed when you set any tone or digital squelch function.

(Mode: FM/FM-N)

- ➔ “TONE” is displayed while the Repeater Tone Encoder is ON.
- ➔ “TSQL (••)” is displayed while the Pocket Beep function with CTCSS is ON.
- ➔ “TSQL” is displayed while the Tone squelch function is ON.
- ➔ “DTCS (••)” is displayed while the Pocket Beep function with DTCS is ON.
- ➔ “DTCS” is displayed while the DTCS squelch function is ON.
- ➔ “TSQL-R” is displayed while the Reverse Tone squelch function is ON.
- ➔ “DTCS-R” is displayed while the Reverse DTCS squelch function is ON.

(Mode: DV)

- ➔ “DSQL (••)” is displayed while the Pocket Beep function with Digital Call Sign squelch function is ON.
- ➔ “DSQL” is displayed while the Digital Call Sign squelch function is ON.
- ➔ “CSQL (••)” is displayed while the Pocket Beep function with Digital Code squelch function is ON.
- ➔ “CSQL” is displayed while the Digital Code squelch function is ON.

3 MODE ICONS

Displays the selected operating mode. (p. 2-8)

- In the DV mode, “DV” is displayed when you set the GPS TX Mode to “D-PRS” or “NMEA.”

4 PRIORITY ICON

Displayed when the Priority watch is turned ON.

5 Bluetooth® ICON (p. 15-6, p. 15-14)

Displayed when you make a Bluetooth® connection between your transceiver that has the optional UT-133 Bluetooth® UNIT installed and a Bluetooth® device.

6 VOX ICON (p. 15-8)

Displayed when you make a Bluetooth® connection between your transceiver that has the optional UT-133 Bluetooth® UNIT installed and the optional VS-3 Bluetooth® HEADSET, and the VOX function is ON.

7 EMR/BK/Packet Loss/Auto Reply ICON

- ➔ “EMR” is displayed when you select the Enhanced Monitor Request (EMR) mode. (p. 7-9)
- ➔ “BK” is displayed when you select the Break-in (BK) mode. (p. 7-8)
- ➔ “L” is displayed when packet loss has occurred. (p. 6-16)
- ➔ “R” is displayed when you select the Automatic Reply function. (p. 7-12)

8 CLOCK READOUT

Displays the current time.

9 RECORD ICON (p.10-2)

Displayed while recording.

- “R” is displayed while the transceiver is recording.
- “P” is displayed while the recording is paused.

10 SD ICON

- ➔ “S” is displayed when a SD card is inserted.
- ➔ “S” and “P” alternately blinks while accessing the SD card.

11 GPS ICON

- ➔ Displays the status of the GPS receiver. (p. 8-2)
- ➔ “••”) is displayed when you set the GPS alarm. (p. 8-36)

12 AUTO POWER OFF ICON (p. 12-2)

Displayed when the Auto power OFF function is ON.

Controller — Display (Touch screen) (Continued)

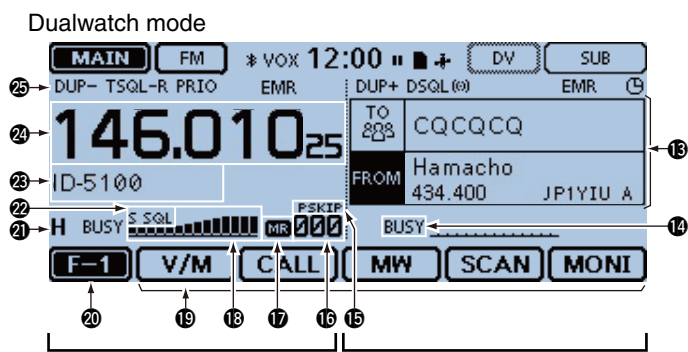

This side becomes the A band in the Single watch mode This side becomes the B band in the Single watch mode

Single watch mode (A band)

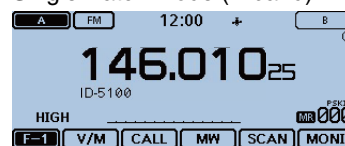

Single watch mode (B band)

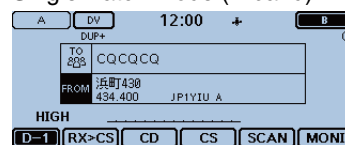

13 DR SCREEN

Displays the DR screen where the D-STAR settings are made.

14 BUSY/MUTE ICON

- “BUSY” is displayed while a signal is being received or the squelch is open.
- “BUSY” blinks while the monitor function is activated. (p. 2-8)
- “MUTE” is displayed while the mute is activated. (p. 2-2)

15 SKIP ICON (p. 4-7, p. 4-10)

Displays the selected Skip function.

- “SKIP”: Memory skip
- “PSKIP”: Program skip

16 MEMORY CHANNEL NUMBER

- Displays the selected Memory channel number, Memory Bank, and so on. (p. 2-9)
 - “WX” is displayed when the Weather channel mode is ON.* (p. 2-9)
- *Only the USA version transceiver.

17 MEMORY ICON (p. 2-9)

Displayed when the Memory mode is selected.

18 S/RF METER

- Displays the relative signal strength of the receive signal. (p. 2-11)
- Displays the output power level of the transmit signal. (p. 2-12)

19 FUNCTION MENU DISPLAY (p. 1-5)

Displays the touch key, according to the selected function menu group.

20 FUNCTION GROUP ICON

Displays the selected function group (F-1 to F-4, D-1 to D-3) (p. 1-5)

21 POWER ICONS

- Displays the output power level of the transmit signal in three levels. (p. 2-12)
- In the Dualwatch mode:
 - “H” is displayed when you select high power.
 - “M” is displayed when you select mid power
 - “L” is displayed when you select low power.

22 S-METER SQUELCH/ATTENUATOR ICONS

- (p. 2-13)
- “S SQL” is displayed when the S-meter squelch is activated.
 - “ATT” appears when the Attenuator function is activated.

23 MEMORY NAME DISPLAY

In the Memory mode, displays the programmed memory name. (p. 3-15)

24 FREQUENCY READOUT

Displays the operating frequency. (p. 2-5)

25 DUPLEX ICON

“DUP-” is displayed when minus duplex is selected, and “DUP+” is displayed when plus duplex is selected. (p. 11-4)

Controller — Display (Touch screen) (Continued)

◇ Function menu

You can toggle the function group to select the desired function keys to operate the transceiver, depending on the transceiver's operating mode or status.

Each function key works for the MAIN band.

- In the VFO, Memory or Call channel mode, you can select the F-1 to F-4 menus.
- In the DR screen, you can select the D-1 to D-3 menus.

- ➔ Touch the group icon to toggle the function group.
- ➔ Touch the group icon for 1 second to display the function menu list.



- 1 [V/M]**
Touch to toggle between the VFO and Memory modes.
- 2 [CALL]**
Touch to turn the Call channel mode ON or OFF.
- 3 [MW]**
 - ➔ Touch to open the Memory Write window.
 - ➔ In the VFO mode or the DR screen, touch for 1 second to store the operating data into the blank channel.
 - ➔ In the Memory or Call channel mode, touch for 1 second to open the Memory Edit screen.
- 4 [SCAN]**
 - ➔ Touch to open the Scan type setting window.
 - ➔ Touch for 1 second to start the last used scan.
- 5 [MONI]**
Touch to turn the Monitor function ON or OFF.



- 6 [SKIP]**
(Appears in the Memory mode.)
Touch to open the Scan Skip setting window.
- 7 [DTMF]**
Touch to open the DTMF send window.
- 8 [VOICE]**
When you insert an SD card into the transceiver's SD card slot, touch to open the "VOICE TX" screen.
- 9 [LOW]**
Touch to open the TX power setting window.
- 10 [GPS]**
Touch to open the GPS item setting window.

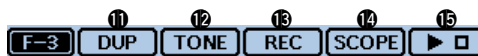

- 11 [DUP]**
Touch to open the duplex direction setting window.
- 12 [TONE]**
(Displayed only when in the FM/FM-N mode.)
Touch to open a Tone function setting window.
- 13 [REC]**
When you insert an SD card into the transceiver's SD card slot, touch to start recording a QSO (communication) audio.
- 14 [SCOPE]**
Touch to open the sweep item setting window.
- 15 [▶ □]**
(Displayed only when you select a sweep operation in [SCOPE](14).)
 - ➔ Touch to start a single sweeping.
 - ➔ Touch for 1 second to start a continuous sweeping.
 - ➔ While sweeping, touch to stop it.



- (Displayed only when in the DV mode.)
- 16 [RX>CS]**
 - ➔ Touch to open the "RX>CS" screen.
 - ➔ Touch for 1 second to set the received station call sign as the destination (UR) call sign.

- 17 [CD]**
Touch to open the "RX HISTORY" screen.

- 18 [CS]**
Touch to open the "CALL SIGN" screen.

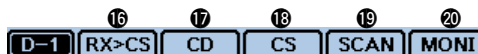

- 19 [SCAN]**
 - ➔ Touch to open the DR scan setting window.
 - ➔ Touch for 1 second to start the last used scan.
- 20 [MONI]**
Touch to turn the Digital Monitor function ON or OFF.

1 PANEL DESCRIPTION

Controller — Display (Touch screen)

◇ Function menu (Continued)



21 [SKIP]

- ➔ Touch to open the skip setting window for the Access repeater scan.
- ➔ Touch for 1 second to set the skip setting in the Function menu.



22 [DSQL]

(Appears in the DV mode.)

Touch to open the Digital squelch function setting window.

If you set the operating mode to “DV” in the VFO mode, [DSQL] is displayed instead of [TONE] on the F-3 menu.

Main unit — Front and rear panels

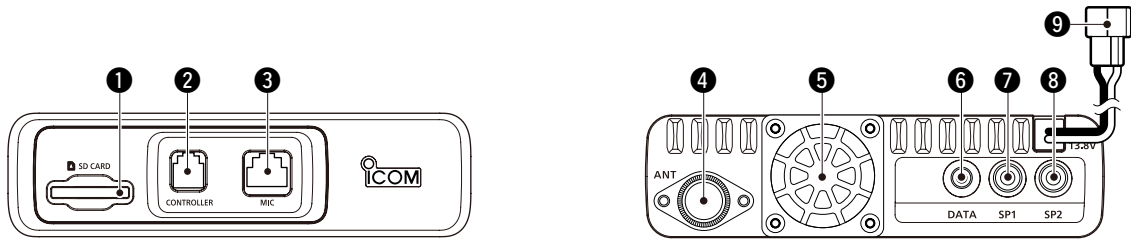

1 SD CARD SLOT [SD CARD]

Insert an SD card (purchase separately). (p. 9-4)

2 CONTROLLER CONNECTOR [CONTROLLER]

Connects to the Controller using the supplied control cable.

3 MICROPHONE CONNECTOR [MIC]

Plug in the supplied microphone (HM-207) or the optional microphone (HM-154).

4 ANTENNA CONNECTOR

Connect a 50 Ω impedance of antenna with a PL-259 connector.

The transceiver has a built-in duplexer, so you can use a 144 and 430 MHz dual-band antenna without needing an external duplexer.

5 COOLING FAN

The cooling fan for heat dissipation.

You can select the Fan control option in the Menu screen; automatically starts to rotate when you begin transmitting, or continuously rotates from power ON.

6 DATA JACK [DATA]

Connect a PC through the optional data communication cable, for cloning (p. 13-12) or low-speed data communication (p. 7-15) in the DV mode.

7 EXTERNAL SPEAKER JACK 1 [SP1]

8 EXTERNAL SPEAKER JACK 2 [SP2]

➤ Connect to an 8 ohm external speaker.

- When you connect external speakers to [SP1] and [SP2], the A band (left side display) audio is heard from [SP1] and the B band (right side display) audio is heard from [SP2].

- When you connect an external speaker to [SP1], the A and B band audio is heard from [SP1]. In this case, the internal speaker is disabled.

- When you connect an external speaker to [SP2], the A band (left side display) audio is heard from the internal speaker and the B band (right side display) audio is heard from the external speaker.

➤ The [SP2] jack is used for external control of the transceiver.

- Connect a PC, using the optional CT-17 CI-V LEVEL CONVERTER, for external control of the transceiver.

- Use for the transceive function with another Icom CI-V transceiver or receiver. When the transceive function is set to ON, changing the frequency, operating mode and so on, on the ID-5100A/E automatically changes those settings on other Icom transceivers or receivers, and vice versa.

9 DC POWER SOCKET [DC 13.8V]

Connect 13.8 V DC power source through the supplied DC power cable.

◇ Microphone connector information

MIC	PIN No.	NAME	DESCRIPTION	SPECIFICATIONS
 <p>Front panel view</p>	1	8 V	+8 V DC output.	Maximum 10 mA
	2	MIC U/D	Frequency Up/Down	UP: Ground DN: Ground through 470 Ω
	3	M8V SW	HM-207 connection Grounds when the HM-207 is connected.	—
	4	PTT	PTT input	Ground for transmission
	5	MIC E	Microphone ground	—
	6	MIC	Microphone input	—
	7	GND	PTT ground	—
	8	DATA IN	When the HM-207 is connected; inputs HM-207 data	—

Microphone (HM-207)

With the HM-207, you can enter numbers for frequency or Memory channel setting, and easily adjust the audio volume or squelch level.

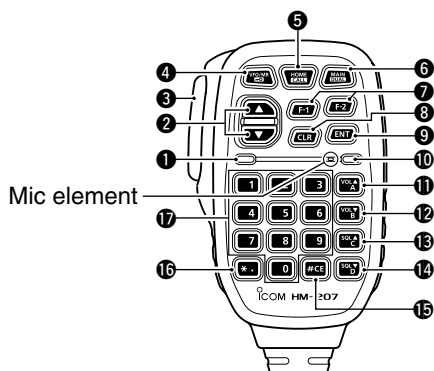

1 LED 1

Lights red while transmitting with [PTT].

2 [▲]/[▼] (UP/DOWN) KEYS

- ➔ Push to change the operating frequency or Memory channel.
- ➔ Hold down to continuously change the frequency or Memory channel.

3 [PTT] SWITCH

Hold down to transmit, release to receive.

4 [VFO/MR] KEY

- ➔ Push to toggle between the VFO and Memory modes.
- ➔ Hold down for 1 second to turn the Lock function ON or OFF.

5 [HOME/CALL] KEY

- ➔ Push to select the Home channel.
- ➔ Hold down for 1 second to turn the Call channel mode ON or OFF.

6 [MAIN/DUAL] KEY

- ➔ In the Single watch mode, push to toggle between the A and B bands.
- ➔ In the Dualwatch mode, push to toggle between the MAIN and SUB bands.
- ➔ Hold down for 1 second to toggle between the Dualwatch and Single watch modes.

7 [F-1] KEY

Push to activate the preprogrammed function of the [F-1] key.
(Default: During RX/Standby: [BAND/BANK]
During TX: [T-CALL])

[F-2] KEY

Push to activate the preprogrammed function of the [F-2] key.
(Default: During RX/Standby: [Monitor]
During TX: [---])

8 [CLR] KEY

In the Menu screen or Quick Menu window, push to return to the standby screen.

9 [ENT] KEY

- ➔ In the VFO mode, push to open the frequency entry window.
- ➔ In the Memory mode, push to open the memory channel number entry window.
- ➔ After entering the number, push to set.

10 LED 2

Lights green when transceiver's power is ON.

11 [VOL▲/A] KEY

- ➔ Push to increase the audio output level.
- ➔ When entering a DTMF code, push to enter 'A.'

12 [VOL▼/B] KEY

- ➔ Push to decrease the audio output level.
- ➔ When entering a DTMF code, push to enter 'B.'

13 [SQL▲/C] KEY

- ➔ Push to increase the squelch level.
- ➔ When entering a DTMF code, push to enter 'C.'

14 [SQL▼/D] KEY

- ➔ Push to decrease the squelch level.
- ➔ When entering a DTMF code, push to enter 'D.'

15 [# / CE] KEY

- ➔ In the frequency entry screen, push to delete a number.
- ➔ When entering a DTMF code, push to enter '#.'

16 [* / .] KEY

- ➔ In the frequency entry screen, push to enter a '.' (decimal point).
- ➔ When entering a DTMF code, push to enter '*.'

17 [0] to [9] KEYS

In the frequency entry window or while entering a DTMF code, push to enter '0' through '9.'

⚡ You can assign a desired function in the Menu screen.

Microphone (HM-207) (Continued)

◇ Setting frequency and Memory channel

[Example for frequency setting]

First, push [VFO/MR•

To enter the 435.680 MHz frequency:

➔ Push [4], [3], [5], [6], [8], [0], then [ENT].

To change the 435.680 MHz to 435.540 MHz:

➔ Push [•], [5], [4], [0], then [ENT].

To enter the 433.000 MHz frequency:

➔ Push [4], [3], [3], then [ENT].

[Example for Memory channel setting]

First, push [VFO/MR•

To select the Memory channel '5':

➔ Push [5] then [ENT].

Power ON and setting audio volume/squelch level.....	2-2
◇ Turning ON the power	2-2
◇ Setting audio volume and squelch level	2-2
Selecting the watch mode	2-3
◇ Selecting the MAIN or SUB band	2-3
◇ Selecting the A or B bands.....	2-3
Selecting the operating band	2-4
◇ Operating band setting	2-4
Direct frequency entry	2-5
Selecting a tuning step	2-6
◇ Tuning step selection.....	2-6
Quick Tuning function	2-7
Selecting a Squelch delay	2-7
Selecting the operating mode	2-8
Monitor function	2-8
Selecting the Mode and the DR function.....	2-9
◇ VFO/Memory/Call channel/Weather channel* mode.....	2-9
◇ DR (D-STAR Repeater) function selection	2-10
Receiving.....	2-11
Transmitting	2-12
◇ Transmitting on an Amateur band	2-12
◇ Settings for the transmission	2-12
◇ About transmit power levels and RF meter	2-12
Lock function	2-13
Attenuator function	2-13
◇ Operating the Attenuator function	2-13
Band Scope function.....	2-14
◇ Sweep operation	2-14
Dualwatch operation	2-15
◇ MAIN band selection	2-15
Microphone gain level setting	2-15
Home channel function.....	2-16
◇ Home channel setting.....	2-16
◇ Home channel operation	2-16
Speech function.....	2-17

Power ON and setting audio volume/squelch level

◇ Turning ON the power

- Hold down [⏻] for 1 second to turn ON the power.
 - A beep sounds and, after the opening message and power source voltage are displayed, the operating frequency appears.
 - Hold down [⏻] for 1 second to turn OFF the power.

▨ You can select the opening message display option in the Menu screen. (p. 12-58)
 Display > **Opening Message**

▨ You can select the power source voltage display option in the Menu screen. (p. 12-58)
 Display > **Voltage (Power ON)**



(Sample)

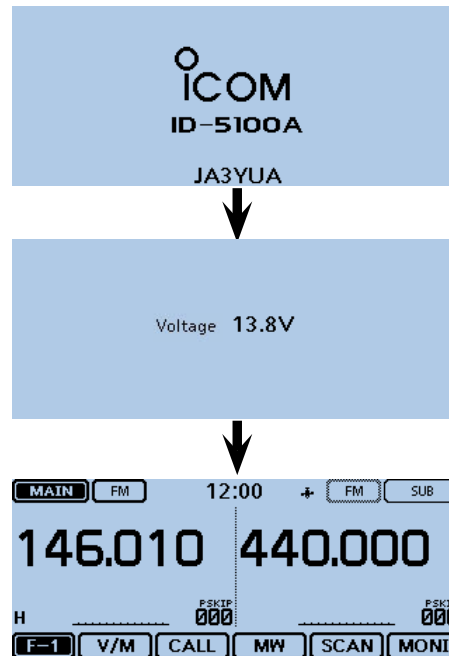

◇ Setting audio volume and squelch level

- ① Rotate [VOL] to adjust the audio level.
 - The beep level is adjusted in the “Beep Level” item of the Menu screen. (p. 12-61)
 Sounds > **Beep Level**
- ② Rotate [SQL] until the noise and the “BUSY” icon just disappear.
 - Rotating [SQL] clockwise makes the squelch tight. The tight squelch is for strong signals.
 - When rotating [SQL] clockwise beyond the center position, [SQL] can be used as ‘S-meter Squelch’ or ‘Attenuator.’ Select the [SQL] option in the Menu screen. (p. 12-52)

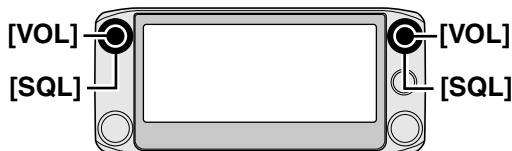

- To mute the audio, touch [QUICK] for 1 second.
 - Releases mute when rotating [DIAL], [VOL] or [SQL], or operating a key, touch screen or microphone.

Selecting the watch mode

The transceiver has two independent watch modes; Dualwatch mode and Single watch mode.

Dualwatch mode

The Dualwatch mode uses the MAIN and SUB bands, and you can simultaneously monitor both bands. In the Dualwatch mode, both MAIN and SUB bands are displayed side by side.

Touching [MAIN] or [SUB] for 1 second selects the Single watch mode.

Single watch mode

The Single watch mode uses the A and B bands, instead of the MAIN and SUB bands, and you can monitor one of them at a time.

In the Single watch mode, only one of the A or B bands is displayed.

Touching [A] or [B] for 1 second selects the Dualwatch mode.

NOTE: The Dualwatch left side band becomes the A band in the Single watch mode. The Dualwatch right side band becomes the B band in the Single watch mode.

◇ Selecting the MAIN or SUB band

- Touch [SUB] to toggle the displayed band between the MAIN band and the SUB band.
 - [MAIN] will be highlighted to indicate the MAIN band.

Dualwatch mode

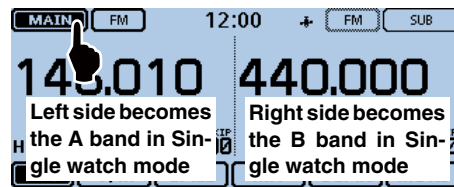

Single watch mode

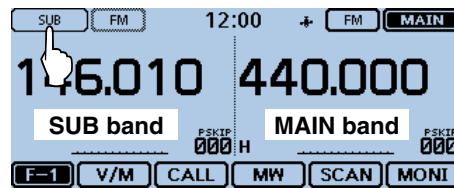
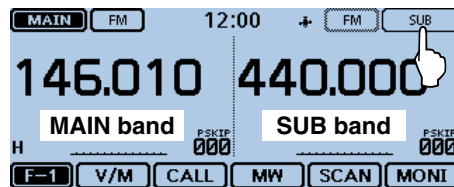
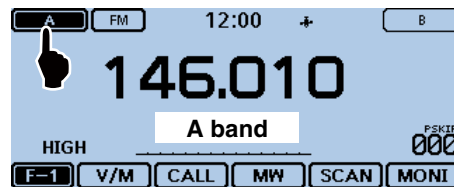

◇ Selecting the A or B bands

- Touch [A] or [B] to toggle the displayed band between the A band and the B band.
 - Either A or B will be highlighted to indicate which band is now displayed.

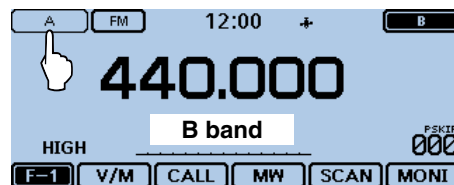
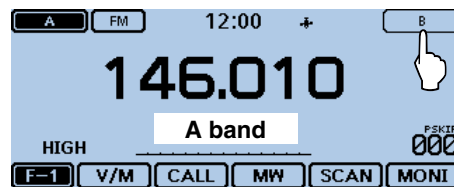

Selecting the operating band

The transceiver can receive the AIR, 144 MHz or 430 MHz bands.

The frequency range on each operating band is shown to the right.

You can transmit on only the 144 MHz and 430 MHz bands.

Operating band	Frequency range
AIR	118.000 MHz to 136.99166 MHz
144 MHz	137.000 MHz to 174.000 MHz
430 MHz	375.000 MHz to 550.000 MHz

The ranges may differ, depending on the transceiver version.

◇ Operating band setting

① Touch the Memory channel number.

- Opens the Mode setting window.

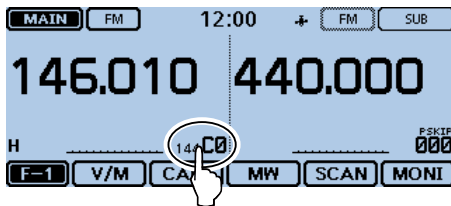

② Touch [VFO].

- Selects the VFO mode.

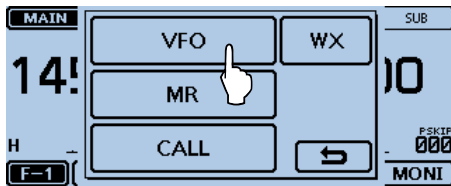

③ Touch the MHz digits.

- Opens the operating band setting window.

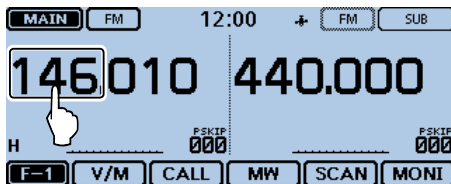

④ Touch the desired operating band.

- The operating band setting window disappears.
- Touch [F-INP] to open the frequency entry window. You can directly enter a frequency.

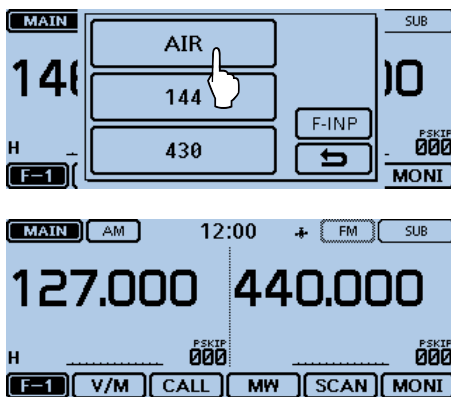

You can select the operating band by touching "Band Select" in the Quick Menu window.

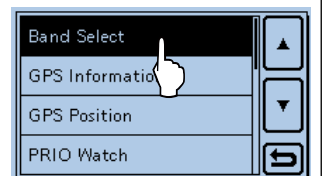

Direct frequency entry

You can directly enter a frequency in the frequency entry window.

- ① Touch the Memory channel number.
 - Opens the Mode setting window.

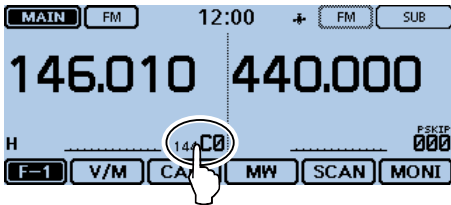

- ② Touch [VFO].
 - Selects the VFO mode.

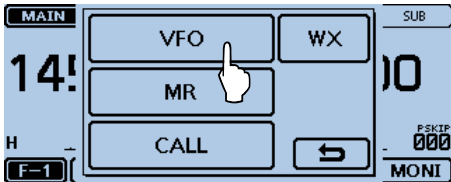

- ③ Touch the MHz digits.
 - Opens the operating band setting window.

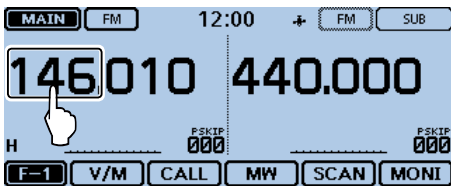

- ④ Touch [F-INP].
 - Opens the frequency entry window.

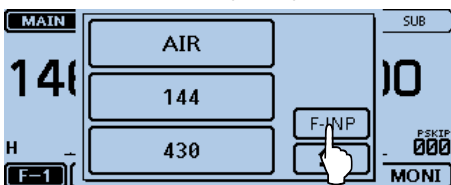

- ⑤ Touch the numbers to enter the desired frequency.
 - The first entered digit is displayed to the left. Then the next entered digit is displayed to the right of the previously entered digit.
 - If desired, touch "CE" to delete the entry.

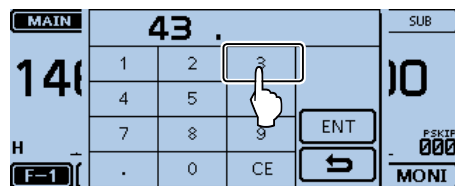
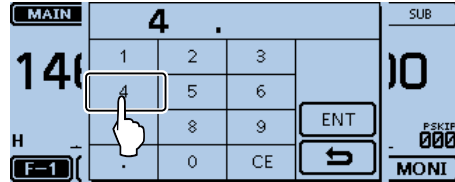

- ⑥ Touch [ENT] to set the frequency.
 - Closes the frequency entry window.
 - If you touch [ENT] without entering a digit below 100 kHz, all unentered digits are set to "0."

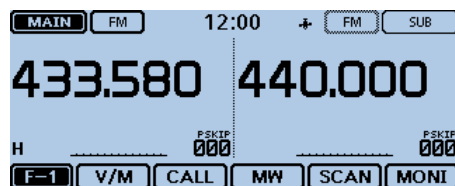
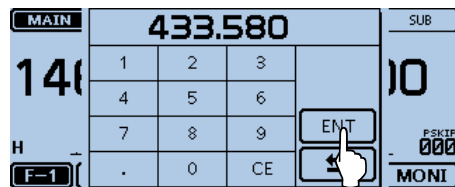

The entered frequency is displayed.

Selecting a tuning step

Rotating [DIAL] changes the frequency in the selected tuning steps.

The VFO scan uses this step to search for a signal.

Tuning steps (kHz)

5	6.25	8.33*	10	12.5	15
20	25	30	50	Auto*	

*Appears only when the AIR band is selected.

/// In the AIR band, you can select only “8.33k”, “25k” and “Auto.”

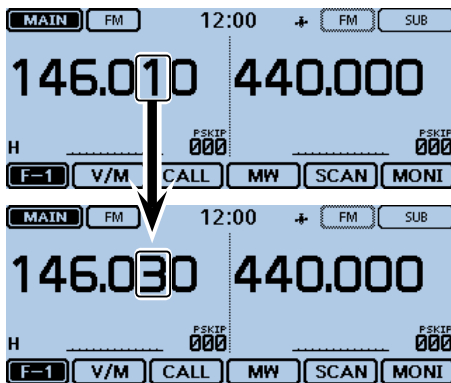

When you select 20 kHz tuning steps, the frequency changes in 20 kHz steps.

◇ Tuning step selection

- ① Touch the kHz digits for 1 second.
 - Opens the Tuning step setting window.

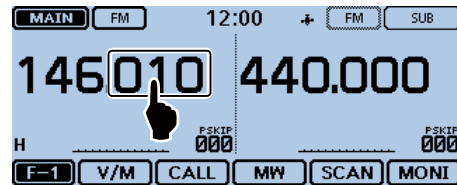

- ② Touch the desired tuning step.
 - Sets the tuning step, and then returns to the previous screen.
 - You can set the tuning step for both the VFO and Memory mode.
 - You can set the tuning step for each band.
 - In the Tuning step setting window, rotating [DIAL] also selects the tuning step.

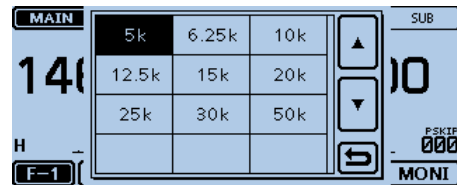

Quick Tuning function

You can change the operating frequency in 'MHz' steps for quick tuning.

- ① Touch the MHz digits for 1 second.
 - Displays the 1 MHz Quick Tuning icon.
 - "▼" appears above the 1 MHz digit.

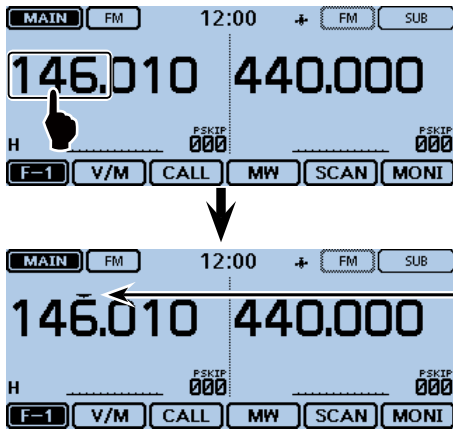

1 MHz Quick Tuning icon

- ② Rotate [DIAL] to change the frequency in 1 MHz steps.
- ③ Touch the kHz digits to cancel the 1 MHz Quick Tuning.

Selecting a Squelch delay

You can select a squelch delay in the Menu screen to prevent repeated opening and closing of the squelch while receiving the same signal.

- ① Touch [MENU].
- ② Touch "Squelch Delay."
 - (Function > **Squelch Delay**)
 - If the item is not displayed, touch [▲] or [▼] one or more times to select another page.

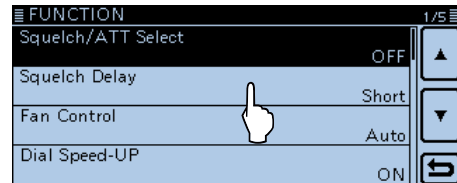

- ③ Touch the desired option.
 - Short: Short squelch delay.
 - Long: Long squelch delay.

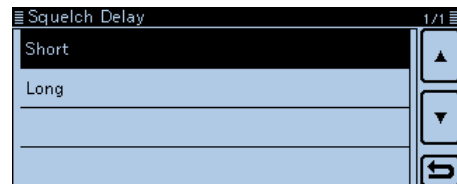

- ④ Touch [MENU]
 - Closes the Menu screen.

Selecting the operating mode

Operating modes are determined by the modulation of the radio signals. The transceiver has a total of five operating modes; AM, AM-N, FM, FM-N and DV. The FM mode is set as a default.

- ① Touch the Mode icon.
 - Opens the operating mode setting window.

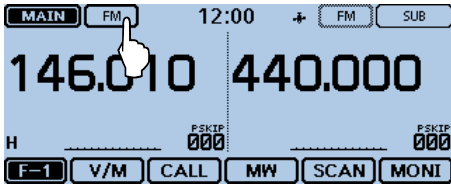

- ② Touch a desired operating mode.
 - You can select the AM or AM-N mode for only the AIR band (118.000 MHz to 136.99166 MHz).
 - You can select the FM, FM-N or DV mode for only the 144 and 430 MHz bands.
 - While in the FM-N mode, the TX modulation is automatically set to narrow (approximately ± 2.5 kHz)
 - While in the DV mode, [GPS] appears in the operating mode setting window, and you can select the GPS TX mode. When the GPS TX mode is set, "DV" is displayed. (p. 8-14)

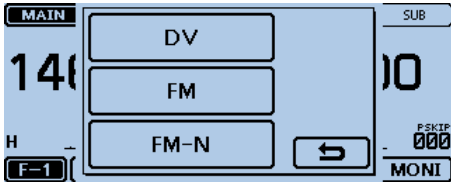

Operating mode setting window

Monitor function

You can use this function to listen to weak signals without disturbing the squelch setting, or having to manually open the squelch, even when mute functions as the tone squelch or digital squelch are in use.

- ① Touch the Function group icon one or more times.
 - Selects the F-1 menu.
- ② Touch [MONI].
 - Touching [MONI] turns the Monitor function ON or OFF.
 - When the Monitor function is ON, "BUSY" blinks and the squelch opens to receive signals.
 - The Monitor function has no effect when the Attenuator is ON. Even if you turn ON the Monitor function, the Attenuator is still ON.

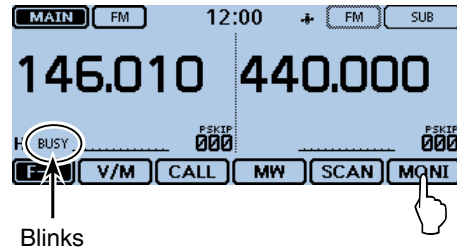

/// You can turn the Monitor function ON or OFF by touching the S-meter area.

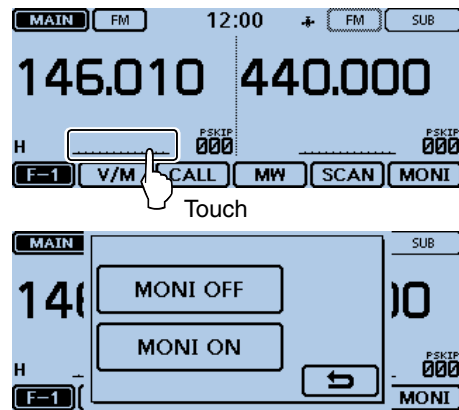

Selecting the Mode and the DR function

◇ VFO/Memory/Call channel/Weather channel* mode

VFO mode

The VFO mode is used to set the operating frequency.

Memory mode

The Memory mode is used to operate on Memory channels.

Call channel mode

The Call channel mode is used to operate on the most-often used frequencies.

Weather channel mode*

The Weather channel mode is used to monitor weather channels from the NOAA (National Oceanographic and Atmospheric Administration) broadcasts.

*Selectable in only the U.S.A. version transceivers.

- ① Touch the Memory channel number.
 - Opens the Mode setting window.

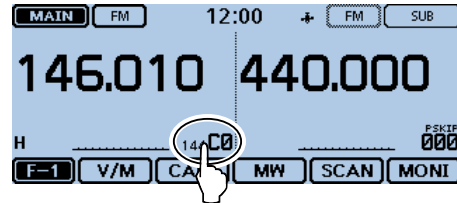

- ② Select the desired Mode.
 - Touch [VFO] to select the VFO mode.
 - Touch [MR] to select the Memory mode.
 - "MR" and the selected Memory channel number are displayed.
 - Touch [CALL] to select the Call channel mode.
 - A selected Call channel number ("144 C0," "144 C1," "430 C0" or "430 C1") is displayed.
 - Touch [WX] to select the Weather channel mode.*
 - The selected weather channel number ("WX-01" to "WX-10") is displayed.
- ③ Rotate [DIAL] to select the operating frequency or a channel.

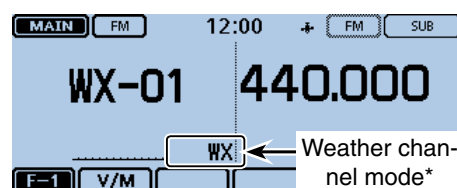
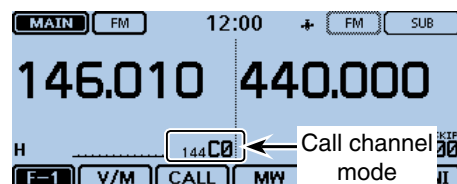
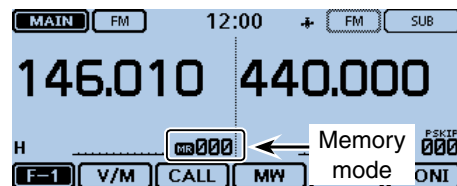
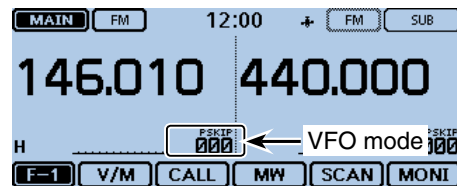

Selecting the Mode and the DR function (Continued)

◇ DR (D-STAR Repeater) function selection

The DR (D-STAR Repeater) function is for D-STAR repeater operation. In this mode, you can easily select the preprogrammed repeaters and UR call signs by rotating [DIAL].

See page 6-4 for the DR function details.

- ① Touch [DR].
 - Displays the DR screen.

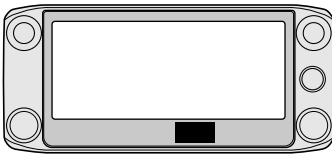

[DR]

- ② Rotate [DIAL] to select a desired access repeater.

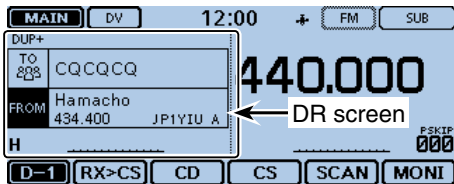

- ③ Touch [DR].
 - Closes the DR screen.

Receiving

Example: Receiving on 146.010 MHz

- ① Touch the Memory channel number.
 - Opens the Mode setting window.
- ② Touch [VFO].
 - Selects the VFO mode.
- ③ Touch the MHz digits.
 - Opens the operating band setting window.

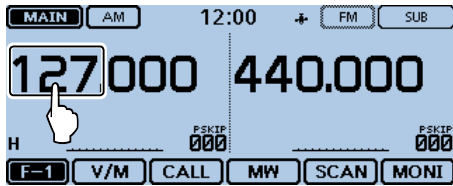

- ④ Touch [144].

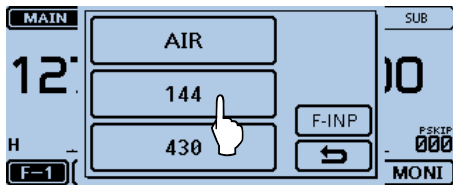

- ⑤ Touch the Mode icon.
 - Opens the operating mode setting window.

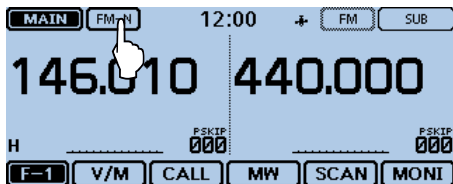

- ⑥ Touch a desired operating mode.

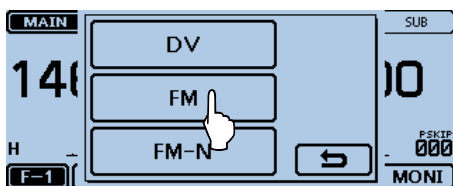

- ⑦ Rotate [DIAL] to select "146.010 MHz."
 - When a signal is received, "BUSY" appears and the S-meter displays the relative signal strength level.

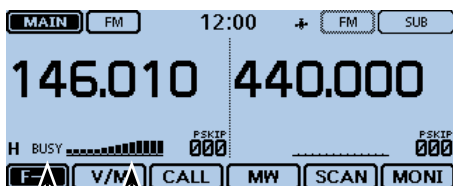

BUSY S-meter

Transmitting

◇ Transmitting on an Amateur band

Before transmitting, monitor the operating frequency to make sure transmitting won't cause interference to other stations on the same frequency.

CAUTION: Transmitting without an antenna may damage the transceiver.

You can transmit on only the 144 MHz and 430 MHz bands.

NOTE:

If the MAIN band frequency is a multiple of the SUB band frequency, you might receive a very small signal on the SUB band when you transmit. This is not a defect, but can occur naturally with the inter-relationship between the fundamental and multiple frequencies.

Example:

MAIN band frequency: 144.200 MHz
 SUB band frequency: 432.600 MHz

The readability of your transmitted signal maybe reduced because audio from the SUB band may be picked up by your microphone when you transmit. If this occurs, reduce the AF volume level on the SUB band.

◇ Settings for the transmission

- ① Set the operating frequency. (p. 2-11)
- ② Touch the Power icon.
 Opens the output power level setting window.
- ③ Touch the transmit output power level.
 Select a level to suit your operating requirements.
 In the Dualwatch mode, "H" indicates high power, "M" indicates mid power and "L" indicates low power.
- ④ Hold down [PTT] to transmit, and speak at your normal voice level.
 - The transmit LED lights red while transmitting.
 - The S/RF meter displays the output power level.
- ⑤ Release [PTT] to receive.

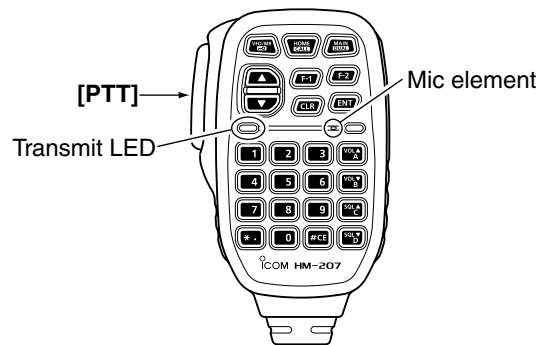

DO NOT hold the microphone too close to your mouth or speak loudly. This may distort your speech.

◇ About transmit power levels and RF meter

The transmit power level and the RF meter displays are shown below.

	RF meter (TX display)	Power level (at TX)
LOW	L TX [meter bars]	5 W
MID	M TX [meter bars]	15 W
HIGH	H TX [meter bars]	25/50 W*

*Depending on the transceiver's version.

Lock function

You can use the Lock function to prevent accidental frequency changes and unnecessary function access.

- ① Touch [QUICK].
- ② Touch "<<Lock>>".
 - If the item is not displayed, touch [▲] or [▼] one or more times to select another page.
 - When the Lock function is turned ON and the locked key is pushed, the touch screen is touched, or [DIAL] is rotated, the "LOCK" dialog box appears.
 - To turn OFF the Lock function, touch [OFF] in the "LOCK" dialog box.
 - You can still use [D], [PTT], [SQL] and [VOL], and [MAIN DIAL], [F-2](Monitor) on the supplied microphone while the Lock function is ON.

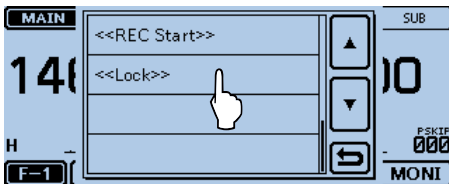

Quick Menu window

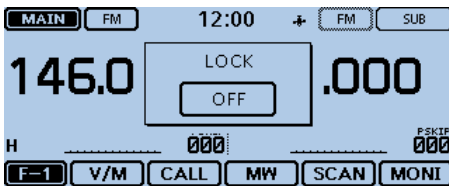

When the touch screen is touched while the Lock function is activated.

Attenuator function

The transceiver has an RF attenuator related to the squelch control setting. You can add up to approximately 20 dB of attenuation at it's maximum setting. You can set the Attenuator to [SQL] in the Menu screen.

- ① Touch [MENU].
- ② Touch "Squelch/ATT Select."
 - (Function > **Squelch/ATT Select**)
 - If the item is not displayed, touch [▲] or [▼] one or more times to select another page.

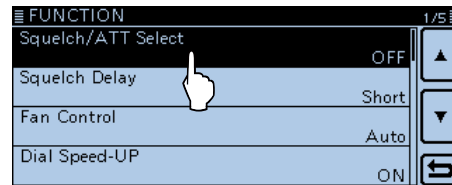

- ③ Touch "ATT."

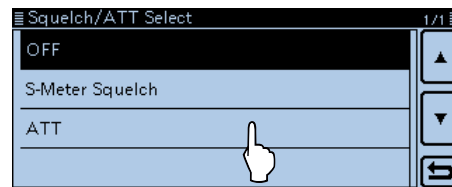

- ④ Touch [MENU]
 - Closes the Menu screen.

◇ Operating the Attenuator function

Rotate [SQL] clockwise past the 12 o'clock position to turn ON the Attenuator and adjust the attenuation level up to approximately 20 dB.

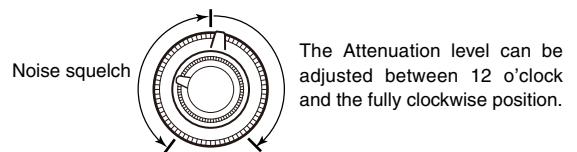

- Displays "ATT."

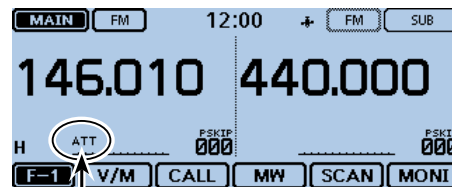

Displayed

Band Scope function

Use the Band Scope function to visually search a specified frequency range around the displayed frequency. You can use this function to search for a signal, and see the received signal strength level.

The Band Scope function has two sweep types, Single sweep and Continuous sweep:

- A Single sweep searches the specified frequency range only once.
- A Continuous sweep repeatedly searches the specified frequency range.

The transceiver sweeps in the following ranges centered on the displayed frequency.

- The sweep steps may differ, depending on the tuning step.
 - Single watch mode: $\pm 38 \times \text{Tuning step}$
 - Dualwatch mode: $\pm 18 \times \text{Tuning step}$ ($\pm 38'$ and $\pm 18'$ are fixed.)

For example in the Dualwatch mode, if the display frequency is 146.010 MHz and its tuning step is 20 kHz, the sweep range is between 145.650 MHz (lower frequency) and 146.370 MHz (higher frequency). (146.010 MHz \pm 0.36 MHz) See the calculation below.

$$\begin{aligned}
 &+18 \times 20 \text{ kHz} = +360 \text{ kHz} (0.36 \text{ MHz}) \\
 &-18 \times 20 \text{ kHz} = -360 \text{ kHz} (-0.36 \text{ MHz}) \\
 &\text{Upper frequency: } 146.370 \text{ MHz} \\
 &\quad (146.010 \text{ MHz} + 0.36 \text{ MHz}) \\
 &\text{Lower frequency: } 145.650 \text{ MHz} \\
 &\quad (146.010 \text{ MHz} - 0.36 \text{ MHz})
 \end{aligned}$$

Example: A strong signal is received on 146.030 MHz.

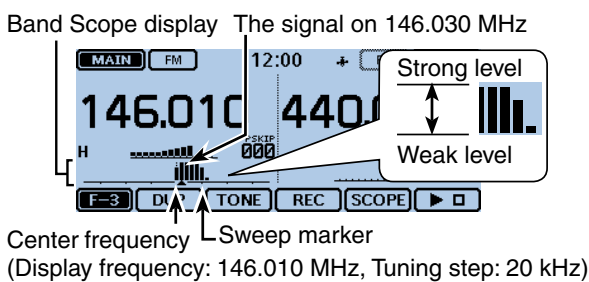

About the sweep steps:

The specified tuning step is used during a sweep. If the tuning step is set too wide, the signals in the sweep range may not be displayed (they may be skipped), even if they are strong signals. Thus we recommend that you set the tuning step to 20 kHz or less to use the Band Scope function. See page 2-6 for tuning step selection details.

- For Single watch operation, you can hear the displayed frequency's audio during a sweep.
- The audio output during a sweep can be turned OFF in the MENU screen.
 - Sounds > **Scope AF Output** (p. 12-61)

◇ Sweep operation

Example: Continuous sweeps centered on 146.010 MHz

- ① Rotate [DIAL] to set 146.010 MHz.
- ② Touch the Function group icon one or more times.
 - Selects the F-3 menu.
- ③ Touch [SCOPE].
 - Opens the Band scope setting window.
- ④ Touch "Continuous Sweep."
 - Returns to the frequency display and starts continuous sweeping.
 - While sweeping, touch [▶□] to stop the sweeping. Touch again to start single sweep.
 - When the sweeping stops, touch [▶□] for 1 second to restart continuous sweeping.

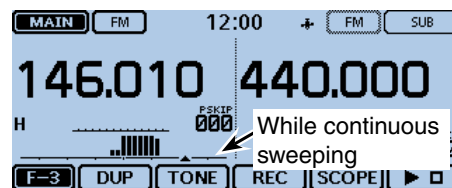

- ⑤ When the sweeping stops, rotate [DIAL] to move the sweep marker to a detected signal.
 - You can hear the signal audio.

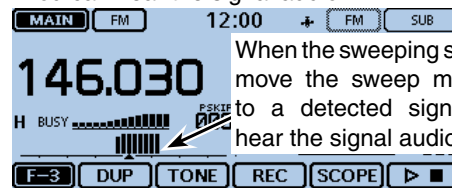

- ⑥ To turn OFF the Band Scope function, touch [SCOPE].
 - Opens the Band scope setting window.

- ⑦ Touch "Scope OFF"

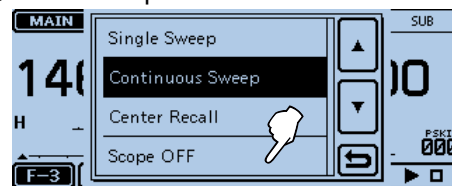

In the Band scope setting window, touch "Center Recall" to set the sweep marker to the center frequency.

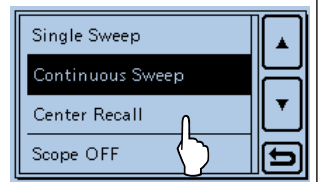

Dualwatch operation

Dualwatch operation simultaneously monitors frequencies in the MAIN and SUB bands. In the Dualwatch mode, the audio output may be interrupted when the frequency is changed while scanning, or by other factors.

Example:
 MAIN band is in the FM mode.
 SUB band is in the DV mode.

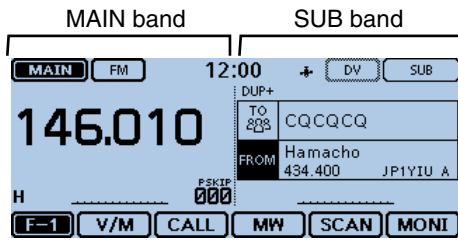

◆ MAIN band selection

- ➔ Touch [SUB] to change the SUB band to the MAIN band.
 - “MAIN” is displayed on the MAIN band, and “SUB” is displayed on the SUB band.
 - The settable items on the SUB band are differ, depending on the “Touch Operation (Sub)” setting in the Menu screen. (Function > Touch Operation (Sub))

The MAIN band is on the left side of the LCD.

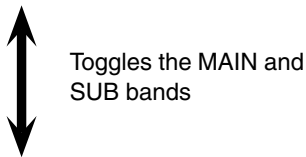
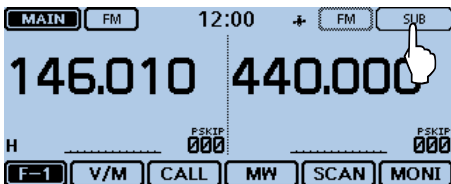

The MAIN band is on the right side of the LCD.

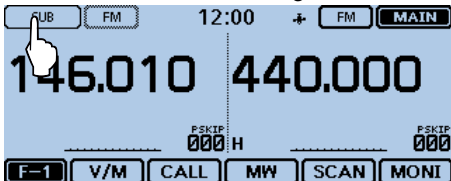

Microphone gain level setting

Set the microphone gain level in the Menu screen.

- ① Touch [MENU].
- ② Touch “MIC Gain.” (Function > MIC Gain)
 - If the item is not displayed, touch [▲] or [▼] one or more times to select the page.

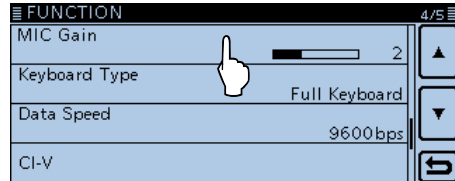

- ③ Touch [+] or [-] to adjust the microphone gain level.
 - Set higher values to make the microphone more sensitive to your voice.

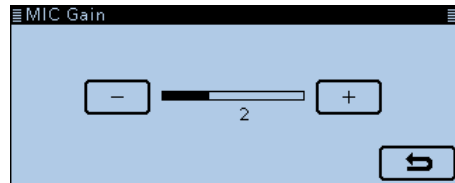

- ④ Touch [MENU]
 - Closes the Menu screen.

Home channel function

Home channels are often-used frequencies you can preset in the transceiver's VFO mode, Memory mode and DR function. Select the Home channel function by just touching [HOME] in each mode.

◇ Home channel setting

- ① Select the desired mode or the DR screen to set the Home channel.
- ② Select a frequency to be set as the Home channel.
 - While in the DR screen, select "FROM."

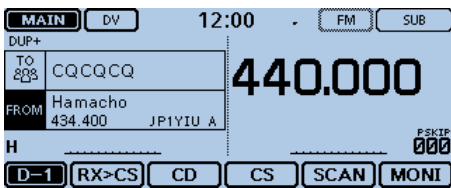

- ③ Touch [HOME] for 1 second.



[HOME]

- ④ Touch the displayed item to set the Home channel.
 - While in the VFO mode, touch "Set Frequency," while in the Memory mode, touch "Set Channel." or while in the DR screen, touch "Set Repeater."

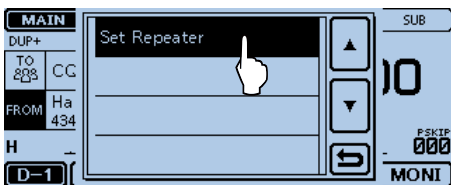

◇ Home channel operation

- ① Select the desired mode or the DR screen in which you want to select the Home channel.
- ② Touch [HOME].
 - Selects the Home channel of the selected mode or DR screen

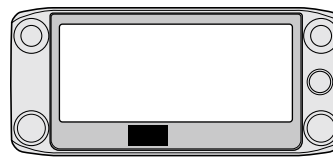

[HOME]

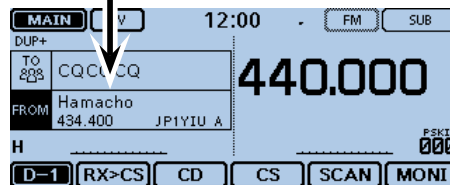
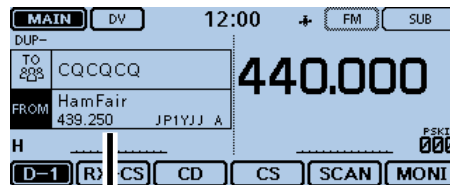

Touching "Clear" in step ④ described above clears the Home channel.



Speech function

When you push [SPEECH], the Speech function audibly announces the displayed frequency and operating mode in the VFO, Memory or Call channel modes, or the call sign of the DR function.

Also, you can use other speech functions, such as the [DIAL] speech function and Mode speech function.

NOTE: When you push [SPEECH] while recording the received audio in the DV mode, the received audio will be muted, and no audio is recorded onto the SD card.

In modes other than the DV mode, the received audio will be recorded.

You set the detail settings of the Speech function in the "SPEECH" item of the Menu screen. (p. 12-46)

Example: When "Hamacho" (JP1YIU A) is selected in "FROM," push [SPEECH].

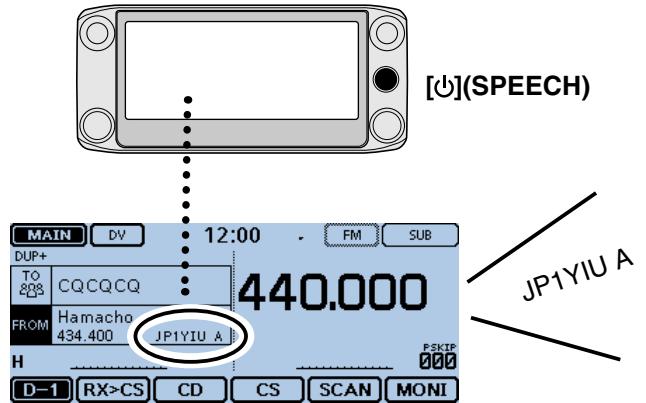

General description.....	3-2
◇ The number of the Memory channel	3-2
◇ Memory channel content.....	3-2
Manage Memory screen description	3-3
◇ Tree view of the Manage Memory screen	3-3
◇ Entering the Manage Memory screen	3-3
Selecting a Memory channel	3-4
Selecting a Call channel	3-5
Writing into a Memory channel	3-6
◇ Writing into the selected channel	3-6
◇ Writing into a blank channel.....	3-6
◇ Overwriting into the selected channel	3-7
◇ Copying Memory content to the VFO	3-8
◇ Copying Memory content to another Memory or Call channel	3-9
Memory bank setting.....	3-10
◇ Assigning a memory channel to a memory bank	3-10
◇ Directly entering into a memory bank.....	3-11
◇ Selecting the Memory bank mode.....	3-12
Entering a Memory or Bank name	3-13
◇ Entering a Memory name	3-13
◇ Entering a Bank name.....	3-14
Selecting a Memory name display	3-15
Clearing a Memory channel.....	3-16

General description

The transceiver has a total of 1000 Memory channels (100 channels in each of 26 memory banks, A to Z) and two Call channels (C0/C1) each for the 144 and 430 MHz bands.

The Memory mode is useful to quickly select often-used frequencies.

◇ The number of the Memory channel

Memory Channels	Descriptions
000–999 (Total of 1000)	Regular Memory channels.
C0/C1	Two Call channels (C0/C1) each for the 144 and 430 MHz bands. Instantly recalls a specified frequency.

◇ Memory channel content

The following information can be entered into the Memory channels:

- Operating frequency
- Duplex direction (DUP+ or DUP–) and frequency offset
- Memory name
- Scan skip setting
- Tuning step
- Operating mode
- Subaudible tone encoder, tone squelch or DTCS squelch ON/OFF
- Subaudible tone frequency, tone squelch frequency or DTCS code with polarity
- UR station call sign
- R1/R2 call signs
- Digital Call sign squelch or Digital code squelch ON/OFF
- Digital code
- Memory bank

NOTE:

Memory content may be accidentally erased by static electricity, electric transients, and other causes. In addition, it may be erased by a malfunction, or during repairs. Therefore, we recommend that you backup the memory content or save it to an SD card or to a PC.

- The SD card is not available from Icom. Purchase an SD card to meet your needs.
- The CS-5100 CLONING SOFTWARE can also be used to backup your memory data.

Manage Memory screen description

The “MANAGE MEMORY” screen enables you to easily edit the Memory or Call channel content.

- View the Memory or Call channel content on a list.
- Easy to assign to a bank, and view the bank content on a list.
- Easy to add, edit, copy or delete the Memory channels.

◇ Tree view of the Manage Memory screen

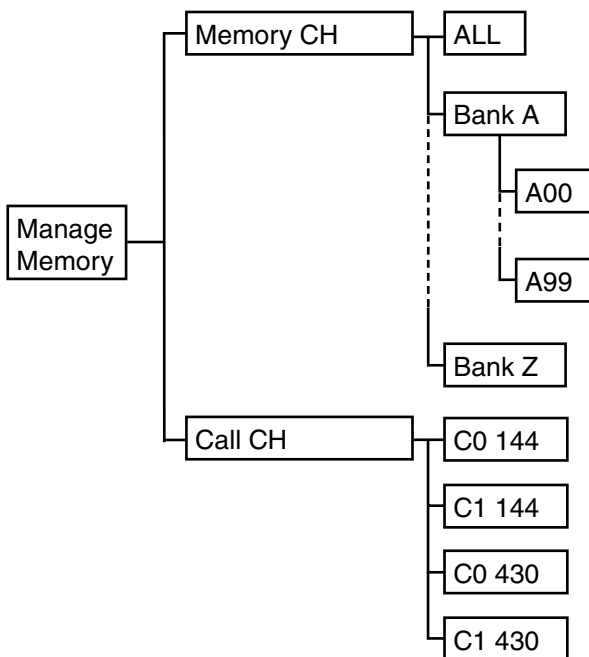

◇ Entering the Manage Memory screen

- ① Touch [MENU].
- ② Touch “Manage Memory.”

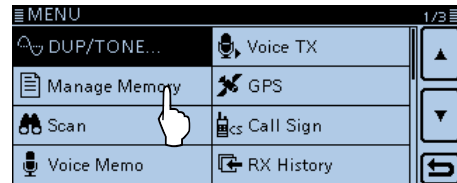

- ③ Touch “Memory CH.”

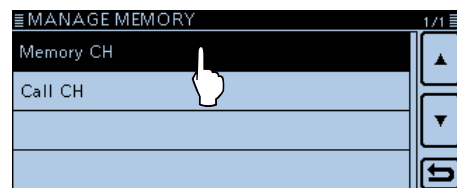

- ④ Touch “ALL.”
 - Displays the “MEMORY CH ALL” screen.

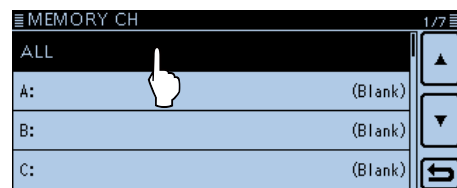

- ⑤ Touch the channel to view the content.

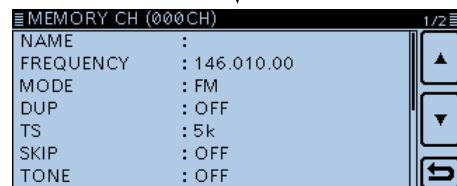
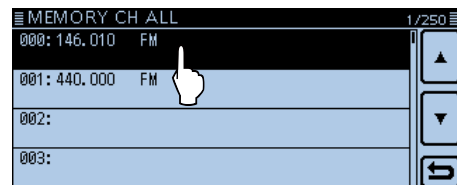

About the Memory channel edit menu:

Touch a channel for 1 second to open the edit menu window.

You can edit, copy or clear the memory content.

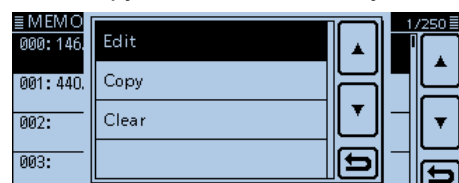

Selecting a Memory channel

- ① Touch the Memory channel number.
 - Opens the Mode setting window.

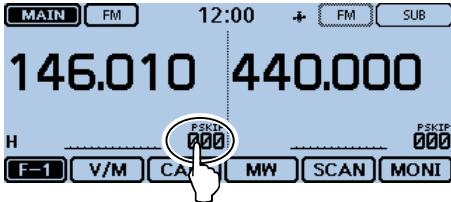

- ② Touch [MR].
 - Selects the Memory mode.
 - Displays "MR" and the selected Memory channel number.

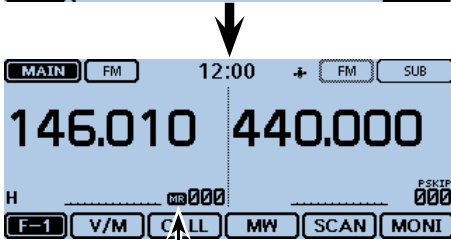
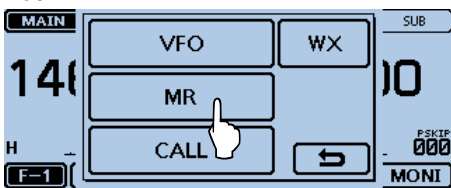

Appears

- ③ Rotate [DIAL] to select a Memory channel.
 - Blank channels cannot be selected.

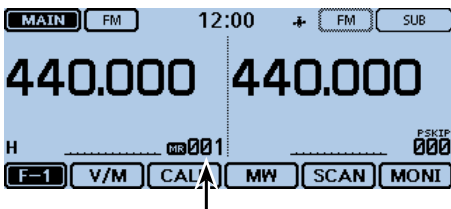

Rotating [DIAL] selects a Memory channel.

For your reference:

- ① Select the Memory mode, and touch the Memory channel number.
- ② Touch [CH-INP].

- ③ Enter the Memory channel number, and then touch [ENT].

Selecting a Call channel

Two Call channels (C0/C1) are selectable in each of the 144 and 430 MHz bands.

Factory default frequencies and operating modes are entered into the Call channels. Change these to suit your operating needs.

- ① Touch the Memory channel number.
 - Opens the Mode setting window.

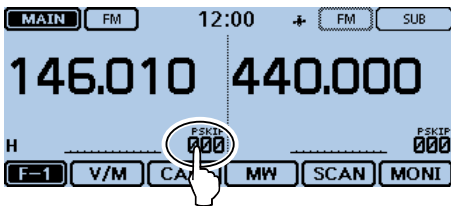

- ② Touch [CALL] to select the Call channel mode.
 - A selected Call channel number ("144 C0," "144 C1," "430 C0" or "430 C1") is displayed.

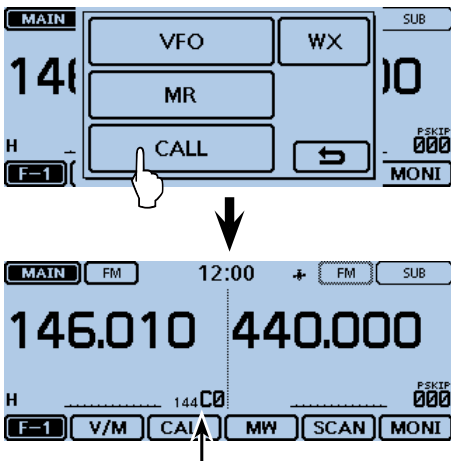

Display the Call channel number

- ③ Rotate [DIAL] to select a Call channel.

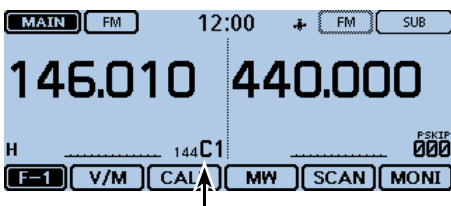

Rotating [DIAL] selects a Call channel.

Writing into a Memory channel

After setting a frequency in the VFO mode, you can write it into a Memory channel.

When writing into a channel, you can select the destination channel between your desired channel or the lowest blank channel.

Memory channels 002 to 999 are blank as the default.

◇ Writing into the selected channel

Example: Writing 146.030 MHz into Memory channel 18.

- ① Touch the Memory channel number.
 - Opens the Mode setting window.
- ② Touch [VFO].
 - Selects the VFO mode.
- ③ Rotate [DIAL] to set 146.030 MHz.
- ④ Touch the Function group icon one or more times.
 - Selects the F-1 menu.
- ⑤ Touch [MW].

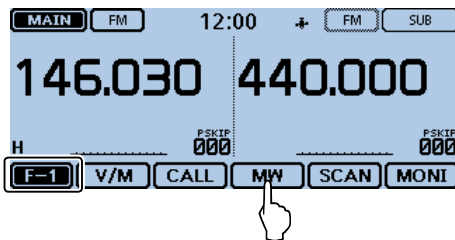

- ⑥ Touch [Write to New CH].
 - Opens the "WRITE" screen.

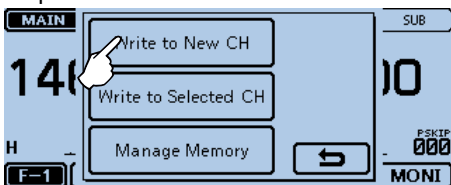

- ⑦ Touch [CH SEL].

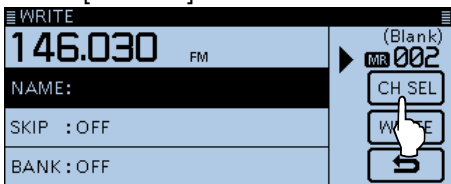

- ⑧ Touch "018."

NOTE: If you select a pre-entered channel, the previous channel content will be overwritten.

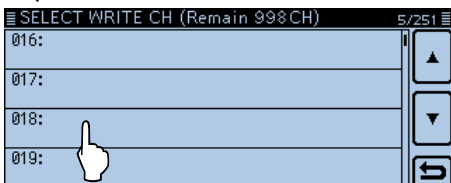

- Call channels are also selectable.

- ⑨ Touch [WRITE].

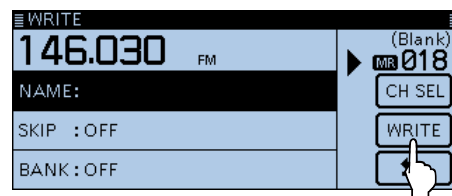

- ⑩ Touch [YES].

- Beeps sound.
- Writes into the selected Memory channel, and returns to the VFO mode.

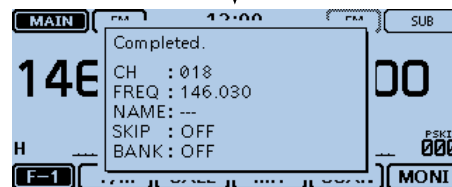
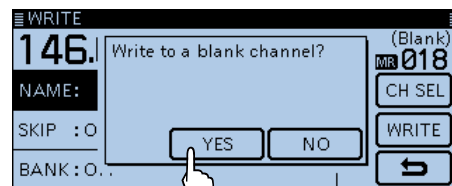

◇ Writing into a blank channel

Example: Writing 146.030 MHz into a blank channel.

- ① Touch the Memory channel number.
 - Opens the Mode setting window.
- ② Touch [VFO] to select the VFO mode.
- ③ Rotate [DIAL] to set 146.030 MHz.
- ④ Touch the Function group icon one or more times.
 - Selects the F-1 menu.
- ⑤ Touch [MW] for 1 second.
 - Writes into the smallest blank, and returns to the VFO mode.

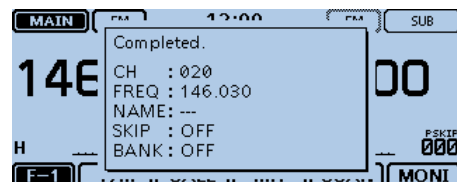

3 MEMORY OPERATION

Writing into a Memory channel (Continued)

◇ Overwriting into the selected channel

You can write a frequency into a pre-entered channel.

Example: Writing 147.010 MHz into Memory channel 18.

- ① Touch the Memory channel number.
 - Opens the Mode setting window.
- ② Touch [MR].
 - Selects the Memory mode.
- ③ Rotate [DIAL] to select the channel 18.

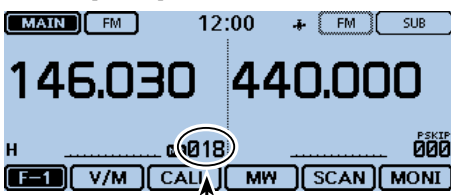

Destination channel

- ④ Selects the VFO mode.
- ⑤ Rotate [DIAL] to set 147.010 MHz.
- ⑥ Touch the Function group icon one or more times.
 - Selects the F-1 menu.
- ⑦ Touch [MW].

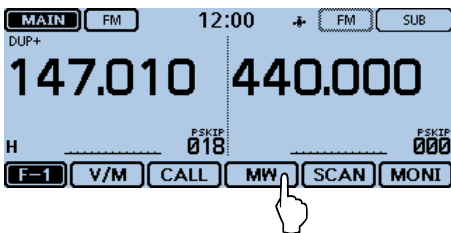

- ⑧ Touch [Write to Selected CH].
 - Opens the "WRITE" screen.

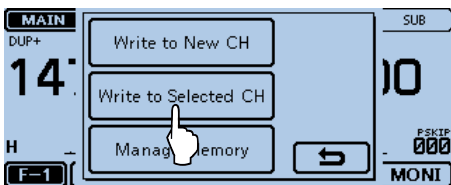

- ⑨ Touch [WRITE].

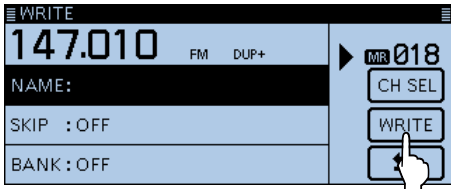

- ⑩ Touch [YES].
 - Beeps sound.
 - Writes into the selected Memory channel, and returns to the VFO mode.

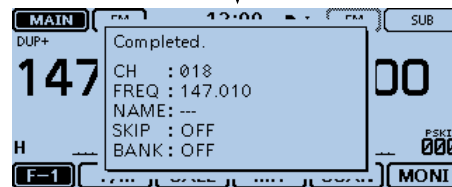
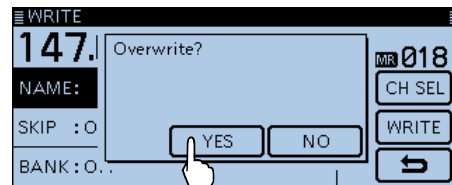

Writing into a Memory channel (Continued)

◇ Copying Memory content to the VFO

It is convenient when you want to operate on the frequency around the Memory or Call channel.

- ① Touch the Memory channel number.
 - Opens the Mode setting window.

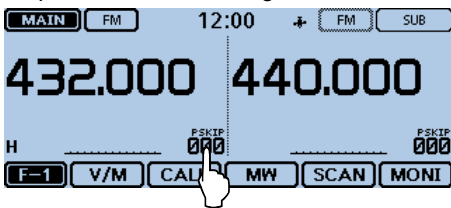

- ② Touch [MR].
 - Selects the Memory mode.

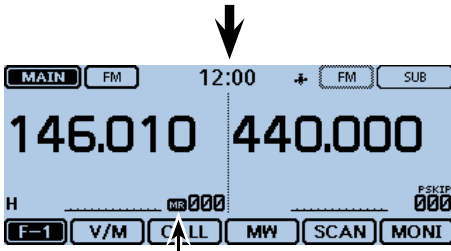
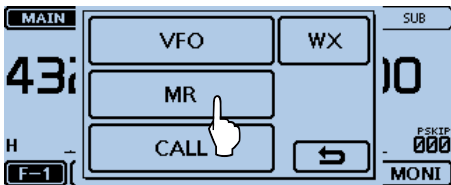

Appears

- ③ Rotate [DIAL] to select the desired channel to be copied.
- ④ Touch the Function group icon one or more times.
 - Selects the F-1 menu.
- ⑤ Touch [MW].
- ⑥ Touch [Copy to VFO].

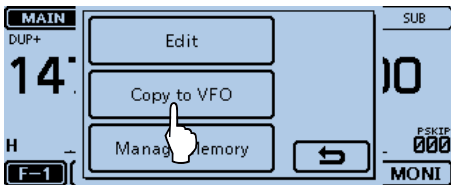

- ⑦ Touch [YES].
 - Beeps sound.
 - Writes the selected Memory content to the VFO, and returns to the VFO mode.

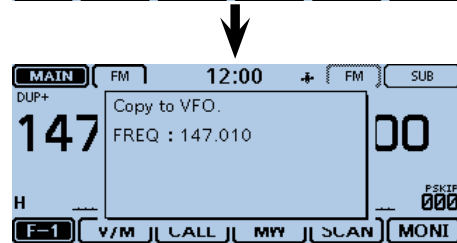
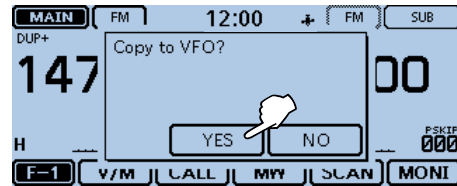

Writing into a Memory channel (Continued)

◇ Copying Memory content to another Memory channel

You can copy the memory content to another Memory channel.

- ① Touch the Function group icon one or more times.
 - Selects the F-1 menu.
- ② Touch [MW].

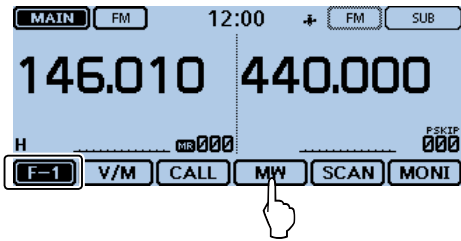

- ③ Touch [Manage Memory].
 - Open the “MANAGE MEMORY” screen.

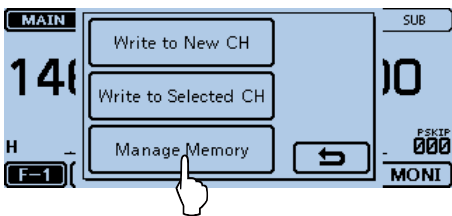

- ④ Touch “Memory CH.”

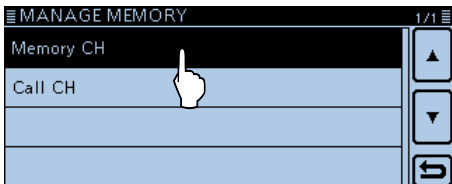

- ⑤ Touch “ALL.”
 - Displays the “MEMORY CH ALL” screen.

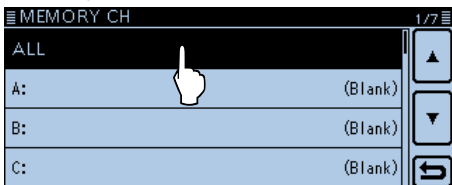

- ⑥ Touch the Memory channel to be copied, for 1 second.

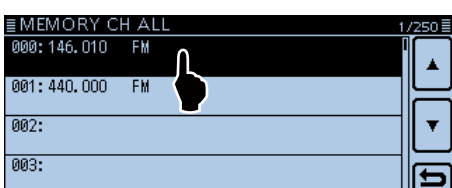

- ⑦ Touch “Copy.”
 - “DESTINATION” blinks at the top left of the screen.

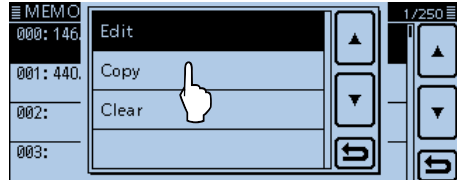

- ⑧ Touch the target channel.
 - Beeps sound.
 - Copies to the destination channel.

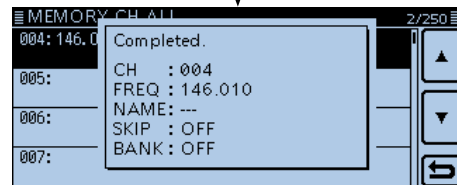
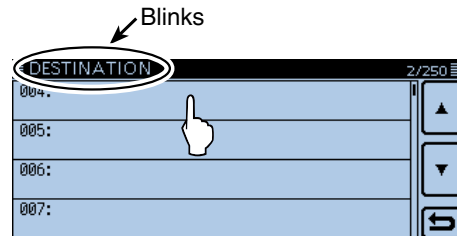

NOTE: If you select a pre-entered channel, the previous channel content will be overwritten.

Memory bank setting

The transceiver has a total of 26 banks (A to Z). Regular memory channels 0 to 999 are assignable to any desired bank for easy memory management. Up to 100 channels can be assigned to a bank.

NOTE: The memory banks are only used to hold memory channels. Thus if the original memory channel content have been changed, the memory bank content are also changed at the same time.

◇ Assigning a memory channel to a memory bank

- ① Touch the Function group icon one or more times.
 - Selects the F-1 menu.
- ② Touch [MW].
- ③ Touch [Manage Memory].
 - Open the “MANAGE MEMORY” screen.

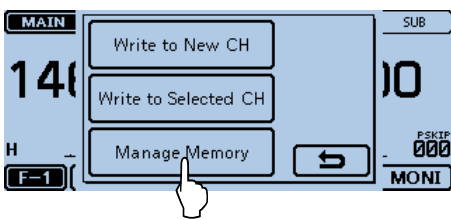

- ④ Touch “Memory CH.”

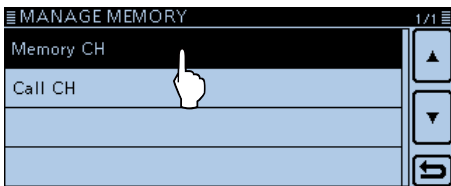

- ⑤ Touch “ALL.”
 - Displays the “MEMORY CH ALL” screen.

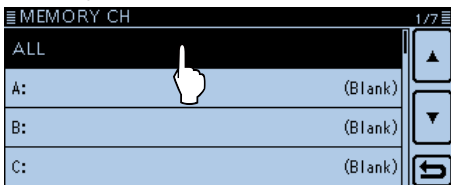

- ⑥ Touch the Memory channel to be assigned to a bank, for 1 second.

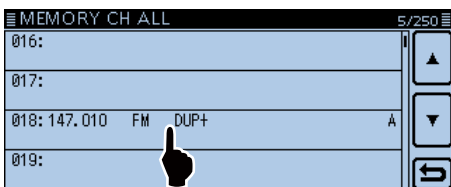

- ⑦ Touch “Edit.”
 - Displays the “MEMORY CH EDIT” screen.

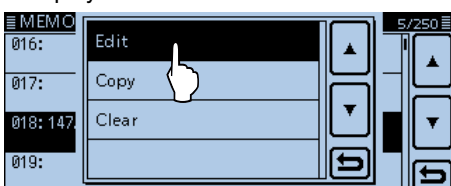

- ⑧ Touch “BANK.”

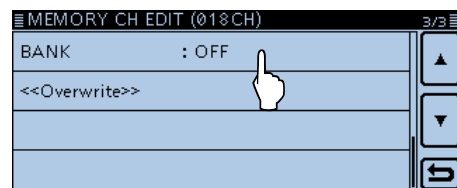

- ⑨ Touch a desired bank group, “A” to “Z.”

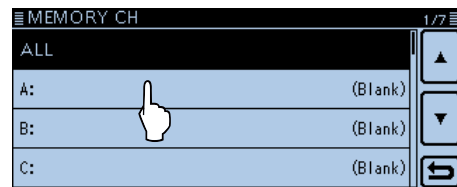

- ⑩ Touch “<<Overwrite>>.”

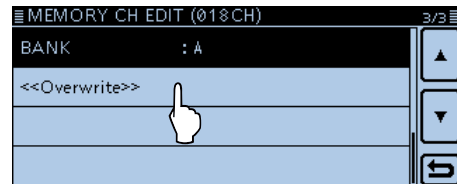

- ⑪ Touch [YES].
 - Assigns the selected memory channel to the bank.

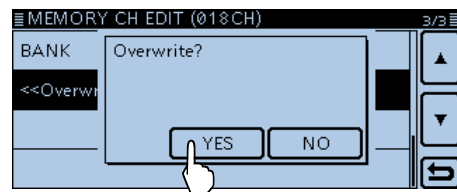

NOTE: If you select a pre-entered channel, the previous channel content will be overwritten.

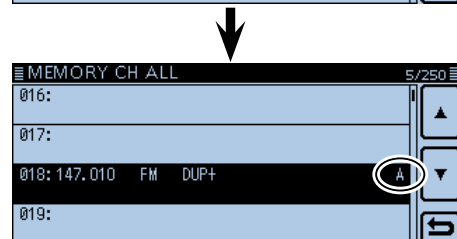
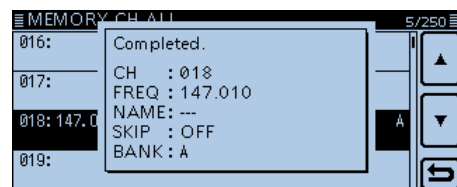

Memory bank setting (Continued)

◇ Directly entering into a memory bank

You can also enter the memory content directly into a memory bank channel. This way is a short cut to creating a memory channel, and then assigning it to a bank. In that case, the transceiver automatically selects the lowest blank memory channel, to program.

Example: Writing 146.030 MHz into Bank A.

- ① Touch the Memory channel number.
 - Opens the Mode setting window.
- ② Touch [VFO].
 - Selects the VFO mode.
- ③ Rotate [DIAL] to set 146.030 MHz.
- ④ Touch the Function group icon one or more times.
 - Selects the F-1 menu.
- ⑤ Touch [MW].
- ⑥ Touch [Write to New CH].
 - Opens the "WRITE" screen.

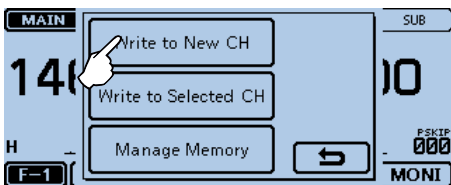

- ⑩ Touch [YES].
 - Writes the memory content to the bank channel.

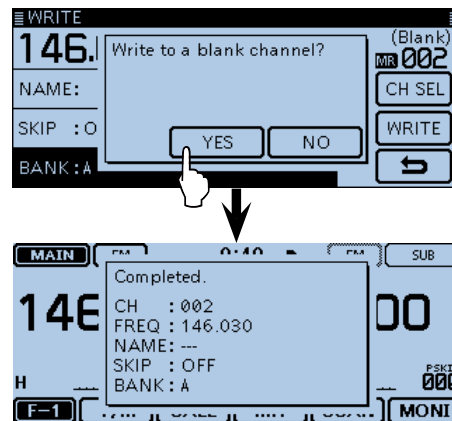

- ⑦ Touch [BANK].

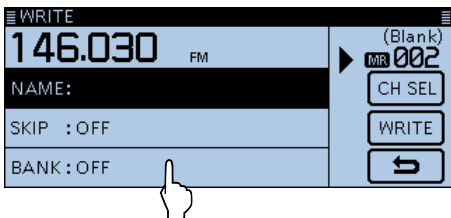

- ⑧ Touch the bank group "A."

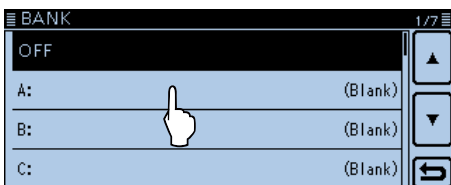

- ⑨ Touch [WRITE].

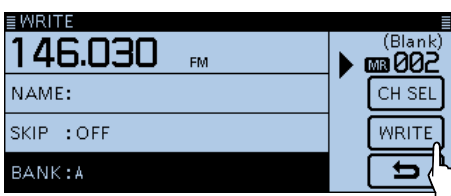

For your reference:

When you touch [CH SEL] in step ⑨, you can select a desired Memory channel. If you select a pre-entered channel, the previous channel content will be overwritten.

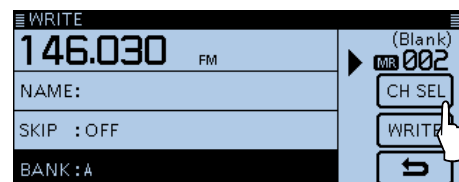

Memory bank setting (Continued)

◇ Selecting the Memory bank mode

When you select the Memory bank mode, rotating [DIAL] selects only the entered bank channels in the selected bank.

- ① Touch the Memory channel number.
- Opens the Mode setting window.

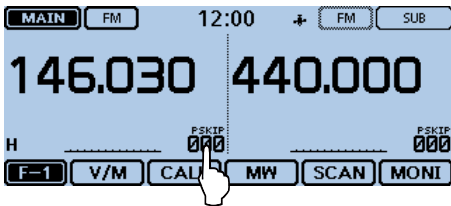

- ② Touch [MR].
- Selects the Memory mode.

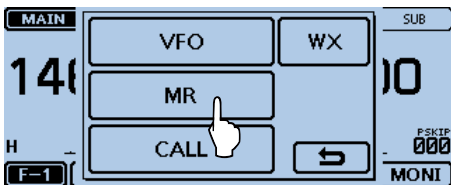

- ③ Touch the Memory channel number.
- Opens the Mode setting window.
- ④ Touch [BANK].
- Only Bank groups that a memory channel is assigned to are displayed.

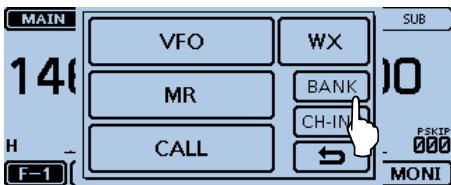

- ⑤ Touch the desired bank.
- Touching "OFF" cancels the memory bank mode.

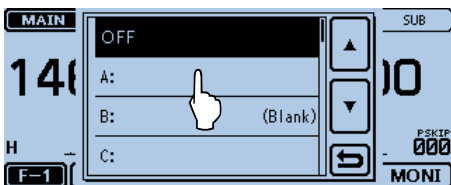

- ⑥ Rotate [DIAL] to select a desired bank channel.
- Only assigned bank channels are displayed.
- To return to the Memory channels display, select "OFF" in step ⑤.

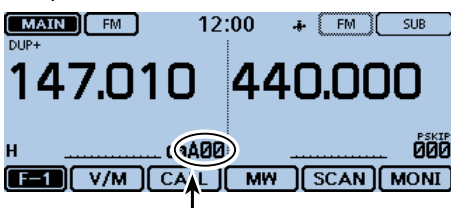

Selected bank channel

Entering a Memory or Bank name

You can enter an alphanumeric name for each Memory, including Call channels, and Banks. Names can be a maximum of 16 characters.

◇ Entering a Memory name

- ① Touch the Function group icon one or more times.
 - Selects the F-1 menu.
- ② Touch [MW].
- ③ Touch [Manage Memory].
 - Open the “MANAGE MEMORY” screen.

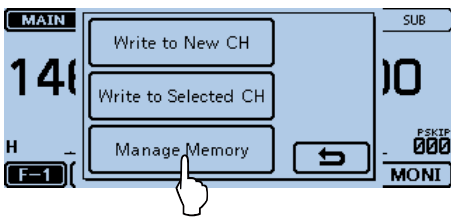

- ④ Touch “Memory CH.”

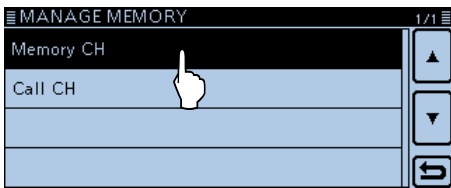

- ⑤ Touch “ALL.”

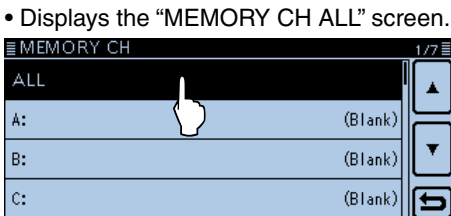

- ⑥ Touch the Memory channel to enter a name, for 1 second.

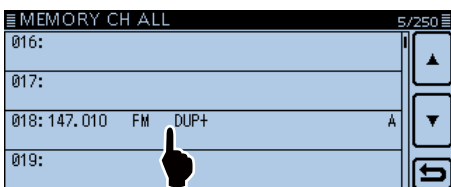

- ⑦ Touch “Edit.”

• Displays the “MEMORY CH EDIT” screen.

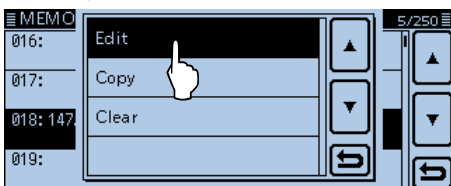

- ⑧ Touch “NAME.”

• Enters the name edit mode.

- ⑨ Touch the keypad.

- Enters the desired character or symbol.
- In the Alphabet entry mode, touch “↑” to enter an upper case letter once, or touch “▲” to continuously enter upper case letters. Touch “▶” to enter lower case letters.
- Touch [[ab]] or [[12]], and then touch [ab], [12] or [(!#)] to select the desired entry mode.

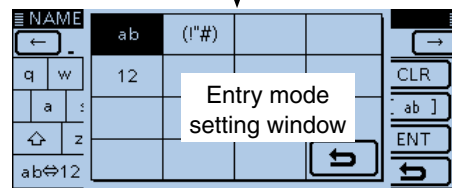
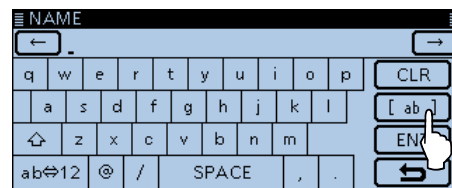

- Touch “ab↔12” to toggle between the Alphabet entry and Number entry modes.
- Touch “SPACE” to enter a space.
- Touch [CLR] to delete the selected character, symbol or number.
- Touch [QUICK], and then touch “Switch to Tenkey” to switch the keyboard type.

Selectable characters and symbols
A to Z, a to z, 0 to 9, ! " # \$ % & ' () * + , - . / : ; < = > ? @ [\] ^ _ ` { } ~ (space)

- ⑩ Touch [←] to move the cursor backwards, or touch [→] to move the cursor forwards.
- ⑪ Repeat steps ⑨ and ⑩ to enter a name of up to 16 characters, including spaces.
- ⑫ After entering, touch [ENT].
- ⑬ Touch “<<Overwrite>>,” and then touch [YES].

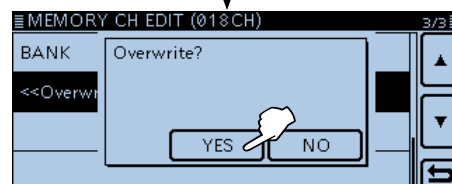
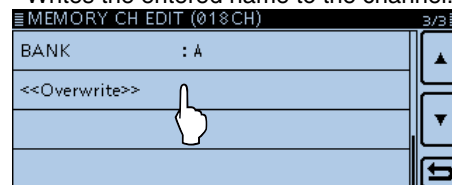

3 MEMORY OPERATION

Entering a Memory or Bank name (Continued)

◇ Entering a Bank name

- ① Touch the Function group icon one or more times.
 - Selects the F-1 menu.
- ② Touch [MW].
- ③ Touch [Manage Memory].
 - Open the “MANAGE MEMORY” screen.

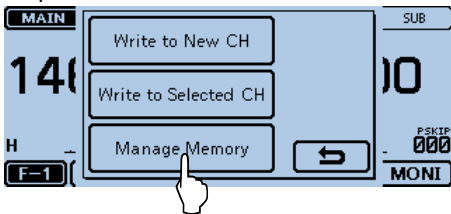

- ④ Touch “Memory CH.”

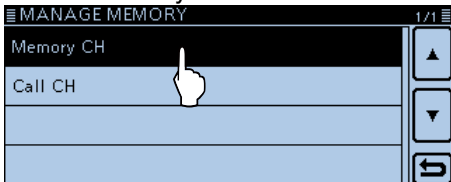

- ⑤ Touch a desired bank group, “A” to “Z,” for 1 second to enter a name.

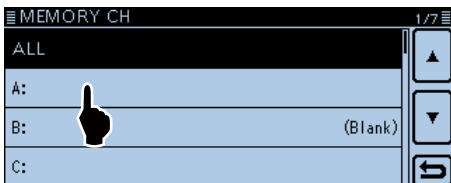

- ⑥ Touch “Edit Name.”

- Enters the bank name edit mode.

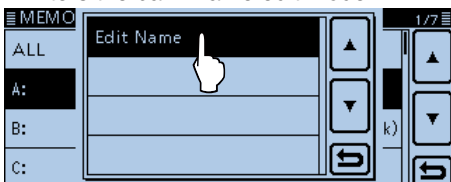

- ⑦ Enter a bank name of up to 16 characters, including spaces. See page 3-13 for entry details.

- ⑧ After entering, touch [ENT].

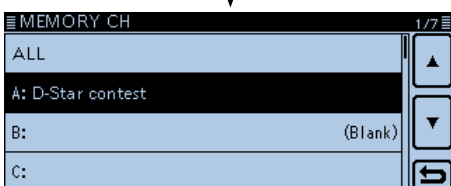
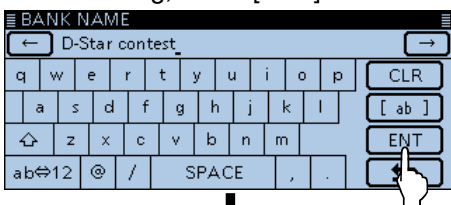

Selecting a Memory name display

The transceiver has three Memory name display types.

- ① Selects the Memory mode.
- ② Touch [QUICK].
- ③ Touch "Display Type."

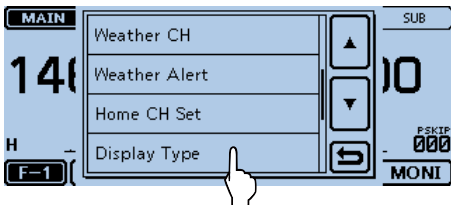

- ④ Touch the desired display type.

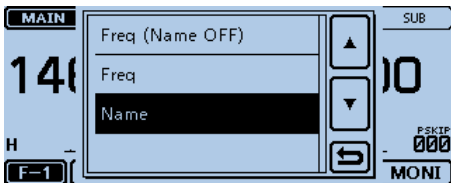

<Display type>

- **Freq (Name OFF)**

Displays only the frequency.

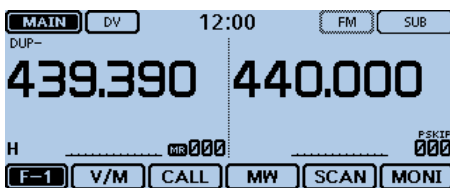

- **Freq**

Displays the large font sized frequency and small font sized memory name.

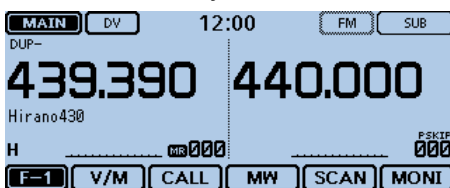

- **Name**

Displays large font sized memory name and a small font sized frequency.

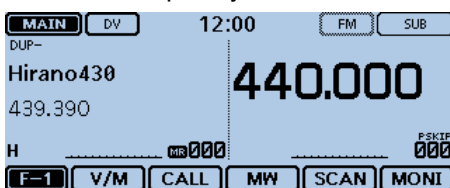

Clearing a Memory channel

Entered memory content can be cleared (erased), if desired.

- ① Touch the Function group icon one or more times.
 - Selects the F-1 menu.
- ② Touch [MW].
- ③ Touch [Manage Memory].
 - Open the “MANAGE MEMORY” screen.

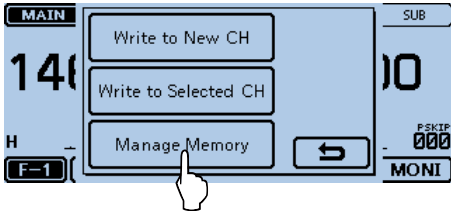

- ④ Touch the desired channel type.
- ⑤ Touch a desired channel to be cleared, for 1 second.

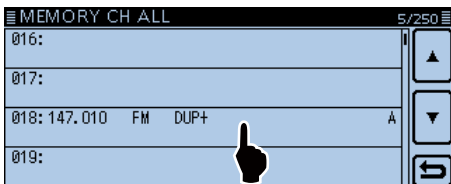

- ⑥ Touch “Clear.”

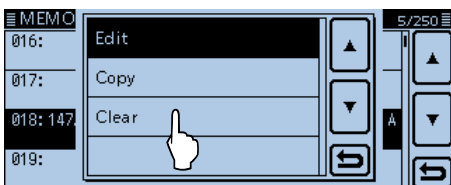

- ⑦ Touch [YES].
 - Beeps sound, and then the memory content is cleared.

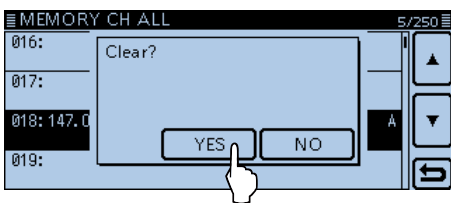

Scan	4-2
◇ About the scan function.....	4-2
◇ VFO scan	4-2
◇ Memory scan.....	4-2
◇ Memory bank scan.....	4-2
◇ [DIAL] operation during a scan.....	4-3
◇ Squelch setting for a scan	4-3
◇ Tuning step for a VFO scan	4-3
◇ Skip function.....	4-3
◇ Temporary Skip timer	4-3
◇ Receive mode during a scan.....	4-3
◇ When a signal is received	4-4
◇ Scan name	4-4
◇ Scan Stop Beep function.....	4-4
◇ Scan function during Dualwatch mode.....	4-4
VFO mode scan	4-5
◇ VFO mode scan	4-5
Setting and clearing the skip frequencies	4-7
◇ Setting the skip frequencies	4-7
◇ Clearing the skip frequencies.....	4-7
Memory scan	4-8
◇ Memory (skip) scan.....	4-8
◇ Memory bank scan.....	4-9
Setting and clearing the skip channel	4-10
Setting the temporary skip function	4-11
Entering scan edges	4-12

Scan

Scanning is a versatile function that can automatically search for signals. A scan makes it easier to locate stations to contact or listen to, or to skip unwanted channels or frequencies.

◇ About the scan function

• In the VFO mode

The frequencies that are set as “PSKIP” are skipped during a scan. (p. 4-7)

/// **NOTE:** At least one program scan edge range must be programmed to start a program scan. (p. 4-12)

• In the memory mode

Repeatedly scans all programmed Memory channels. The frequencies that are set as skip channels “PSKIP” and “SKIP” are not scanned. (p. 4-7)

/// **NOTE:** Two or more memory channels must be programmed to start a memory scan.

[Duplex (DUP) scan]

The Duplex scan searches for both TX and RX frequencies which are used in duplex operation. (p. 11-4)

- The “DUP-” or “DUP+” icon is displayed in the duplex mode.
- A duplex scan will not start when the frequency offset is set to “0.000 MHz.”

[Tone scan]

The tone scan searches for tone frequencies or DTCS codes that are used by stations using the Tone Squelch function.

- A tone scan can be made in any mode: VFO, memory or Call channel.
- During a tone scan, rotate [DIAL] to switch scan direction. Refer to “Tone Squelch function” or “DTCS code Squelch function” for details. (p. 13-8, p. 13-9)

◇ VFO scan

• ALL (Full scan) p. 4-5

Repeatedly scans the entire band.

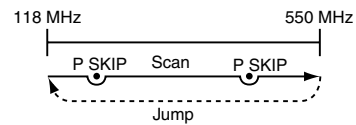

• BAND (Selected band scan) p. 4-5

Scans all frequencies over the entire selected band.

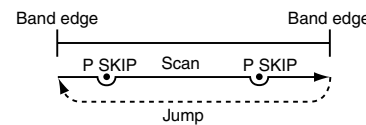

• PROG 0–24 (Program scan) p. 4-5

Scans the program scan edge ranges. (Scan > **Program Scan Edge**)

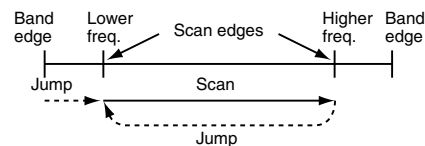

• P-LINK0–9 (Program link scan) p. 4-5

Sequentially scans the program scan edge ranges which are set to link in the “PROGRAM LINK” item in the Menu screen. (p. 12-15) (Scan > **Program Link**)

◇ Memory scan

• ALL (Memory full scan) p. 4-8

Scans all memory channels.

• BAND (Selected band memory scan) p. 4-8

Scans all Memory channels on the same frequency band as the selected channel.

• MODE (Mode memory scan) p. 4-8

Scans memory channels which are programmed with the same receiving mode as the currently selected mode.

◇ Memory bank scan

• ALL (Full bank scan) p. 4-9

Scans all banks.

• BANK-LINK (Bank link scan) p. 4-9

Sequentially scans the banks which are set to link in the “BANK LINK” item in the Menu screen. (Scan > **Bank Link**)

• BANK-A–Z (Bank scan) p. 4-9

Scans the memory channels in the selected bank.

Scan (Continued)

◇ [DIAL] operation during a scan

- If desired, rotate [DIAL] to switch the scanning direction during a scan.
- When the scan is paused, rotate [DIAL] to resume the scan.

◇ Squelch setting for a scan

The squelch level can be changed to suit your operating needs. Set the squelch level to open the squelch, according to the received signal strength.

- During a scan, rotate [SQL] to adjust the squelch level.

◇ Tuning step for a VFO scan

The selected tuning step is applied to the scan. For a program scan or program link scan, set the tuning step in the program scan edge ranges.

◇ Skip function

The skip function speeds up scanning by not scanning those frequencies set as skip channels. (p. 4-9, p. 4-10)

When the “Program Skip” item is set to OFF, the Scan Skip function cannot be used. (p. 12-14)
(Scan > Program skip)

◇ Temporary Skip timer

The Temporary Skip function temporarily skips unwanted frequencies during a scan, for the set time period.

- These settings can be changed in the Menu screen. (p. 4-11)
(Scan > Temporary Skip Timer)

◇ Receive mode during a scan

- The selected mode is used by the scan.
- During a memory or bank scan, the mode programmed into the channel is used by the scan.

Scanning in the FM mode

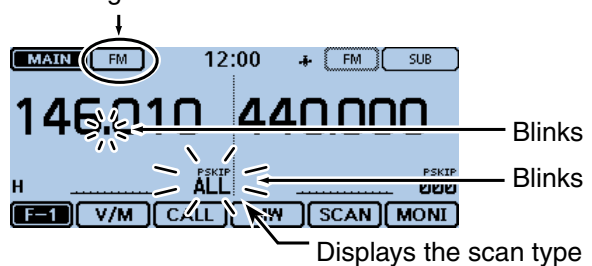

Scan (Continued)

◇ When a signal is received

When a signal is received, the scan pauses for approximately 10 seconds (default), then resumes. The scan resumes approximately 2 seconds (default) after the signal disappears.

- To manually resume the scan, rotate [DIAL].
- These settings can be changed in the Menu screen. (p. 12-14)
- (Scan > **Pause Timer**)
- (Scan > **Resume Timer**)

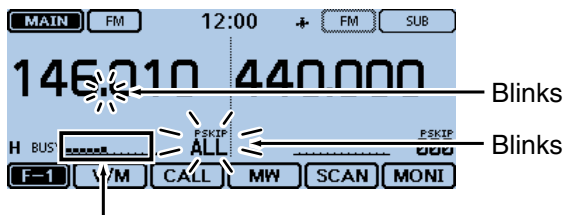

The S-meter shows the received signal strength.

◇ Scan name

A desired name can be assigned to each Program scan edge or Program scan link channel. (p. 4-12) By selecting the scan name, the scanning frequency range will be set.

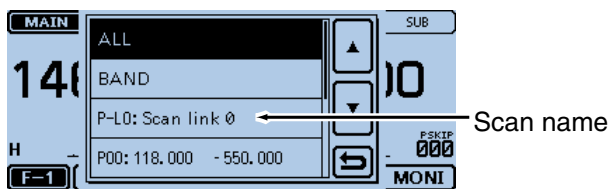

The scan type setting window

◇ Scan Stop Beep function

The Scan Stop Beep function sounds a beep when a signal is received. The function can be turned ON or OFF in the Menu screen. (p. 12-61) (Sounds > **Scan Stop Beep**)

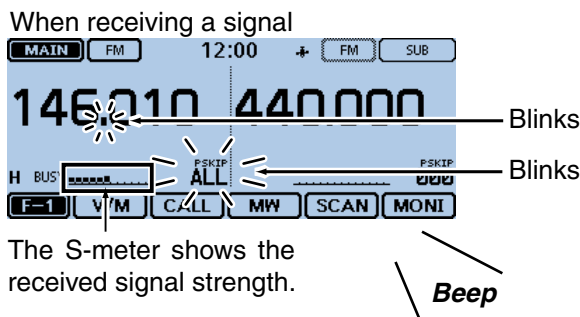

The S-meter shows the received signal strength.

◇ Scan function during Dualwatch mode

When the DV signal is simultaneously received on both MAIN and SUB bands, the SUB band audio signal is muted.

Example: While receiving a DV signal on the MAIN band, the transceiver receives other DV signal on the SUB band.

You can hear only the MAIN band audio.

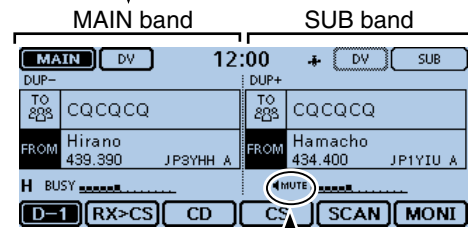

The SUB band audio signal is muted.

Example: While waiting for a DV signal on the MAIN band, the transceiver receives another signal from a DV repeater on the SUB band.

You can hear the SUB band audio.

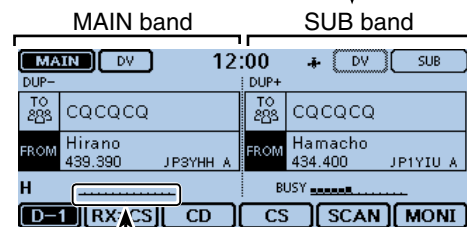

Signal is not received.

VFO mode scan

There are 6 scan types: Full scan, Band scan, Program scan, Program link scan, Duplex scan and Tone scan.

NOTE:
 The frequencies that are set as skip channels "PSKIP" are skipped during a scan.
 When the "Program Skip" item in the Menu screen is set to OFF, the frequencies that are set as skip channels "PSKIP", are not skipped during a scan.
 (Scan > Program Skip)

◇ VFO mode scan

- ① Touch the Memory channel number.
 - Opens the Mode setting window.
- ② Touch [VFO].
 - Selects the VFO mode.
- ③ Touch the MHz digits.
 - Opens the operating band setting window.
- ④ Touch the desired operating band.
- ⑤ Touch the Mode icon.
 - Opens the operating mode setting window.
- ⑥ Touch a desired operating mode.
- ⑦ Touch the Function group icon one or more times.
 - Selects the F-1 menu.
- ⑧ Touch [SCAN].
 - Opens the scan type setting window.

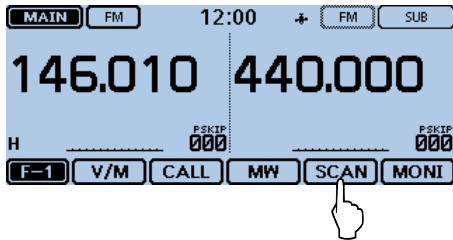

- ⑨ Touch the desired scan type.
 - ALL: Full scan
 - BAND: Band scan
 - P-LINK0-9: Program link scan
 - P00-24: Program scan
 - DUP: Duplex scan (p. 4-2)
(Appears only when duplex is set.)
 - TONE: Tone scan
(For tone squelch scanning)

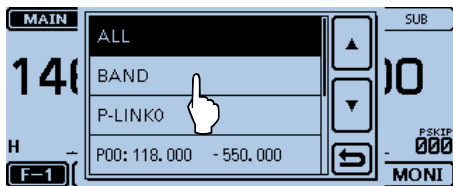

- ⑩ The scan starts.
 - If desired, rotate [DIAL] during a scan to switch the scanning direction.
 - If desired, touch the Mode icon during a scan to change the operating mode.
 - The scan runs even while the Menu or Quick Menu screen is displayed.

During a Band scan

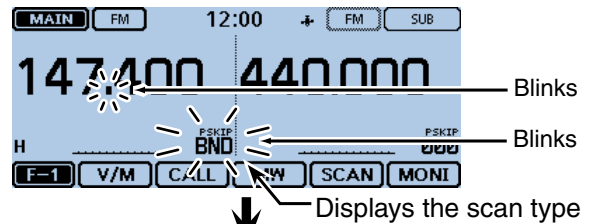

When receiving a signal

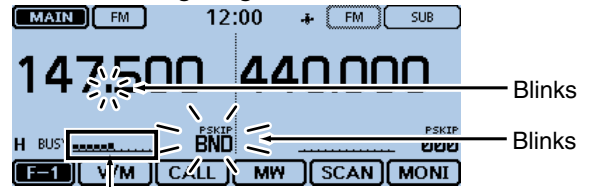

The S-meter shows the received signal strength.

- ⑪ To cancel the scan, touch [SCAN].
 - Touching the frequency readout also cancels the scan.

About Program scan

You can set the tuning step and the operating mode used for a program scan or program link scan. See page 4-12 for details.

VFO mode scan (Continued)

When a scan name is assigned.

When a scan name is assigned, the scan name is displayed on the scan type setting window. (Step ④ on page 4-5)

See page 4-12 to enter the scan name.

NOTE: The scan name is not displayed during a scan.

• When the scan name is assigned

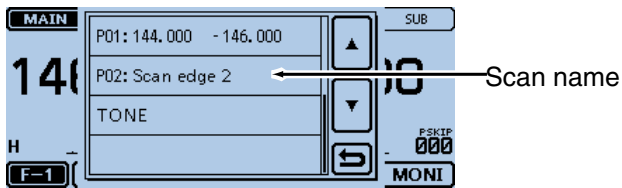

• When the scan name is not assigned

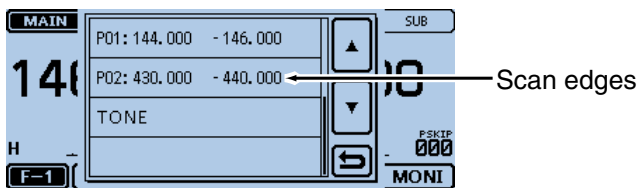

When a program link name is assigned.

When a program link name is assigned, the program link name is displayed on the scan type setting window. (Step ④ on page 4-5)

See page 12-16 to enter the program link name.

NOTE: The program link name is not displayed during a scan.

• When the program link name is assigned

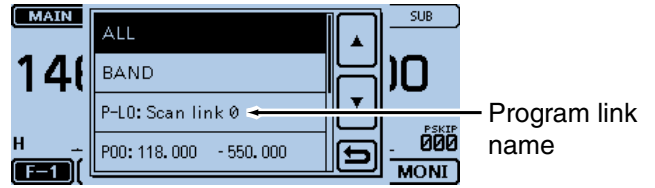

• When the program link name is not assigned

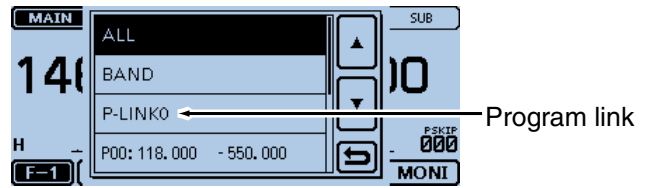

Setting and clearing the skip frequencies

◇ Setting the skip frequencies

The frequencies set as “PSKIP” skip channels are not scanned.

- Start the VFO scan. (p. 4-5)
 - When a signal is received, the scan pauses.

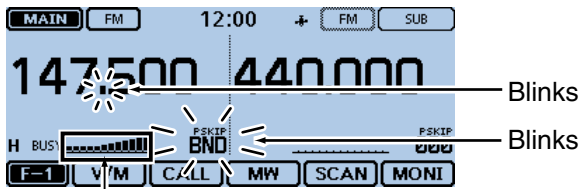

The S-meter shows the received signal strength.

- Touch the Function group icon one or more times.
 - Selects the F-2 menu.
- While the scan is paused, and if you want to skip the frequency, touch [SKIP] for 1 second (until 3 beeps sound).
 - When a signal is received during the scan, the transceiver attempts to enter the frequency as a skip channel into empty memory channel 999.
 - The entered memory channel number blinks.
 - If channel 999 already has content, the transceiver automatically searches for another blank channel to use. If no blank memory channel is found, a beep sounds, and no skip channel is set.

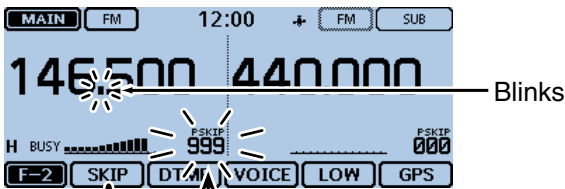

A skip frequency is entered into channel 999.

- After the skip channel is set, the scan resumes.

◇ Clearing the skip frequencies

- Touch the Memory channel number.
 - Opens the Mode setting window.
- Touch [MR].
 - Selects the Memory mode.
- Rotate [DIAL] to select the memory channel you want to clear as the skip channel.

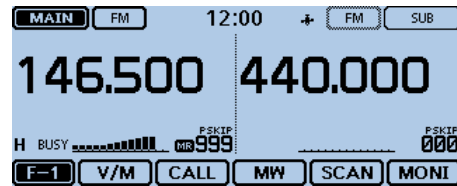

- Touch the Function group icon one or more times.
 - Selects the F-2 menu.
- Touch [SKIP].
 - Open the skip setting window.

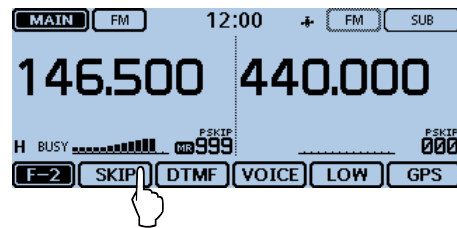

- Touch “OFF.”

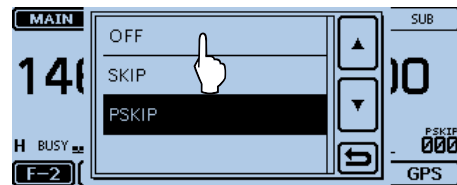

- The skip setting is canceled.

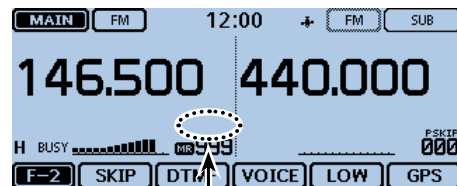

For your reference:
 The skip setting is also cancelled when the memory channel set as skip channel is deleted.
 See page 3-16 for details.

Memory scan

Repeatedly scans all programmed Memory channels. There are two types of scans in the memory mode; Memory scan and memory bank scan.

- Channels set as “PSKIP” or “SKIP” are skipped during a scan.
- Two or more memory channels, which are not set as skip channels, must be programmed into start a memory scan.

◇ Memory (skip) scan

The memory channels set as “PSKIP” or “SKIP” skip channels are not scanned.

- ① Touch the Memory channel number.
 - Opens the Mode setting window.
- ② Touch [MR].
 - Selects the Memory mode.
- ③ Touch the Function group icon one or more times.
 - Selects the F-1 menu.
- ④ Touch [SCAN].
 - Opens the scan type setting window.

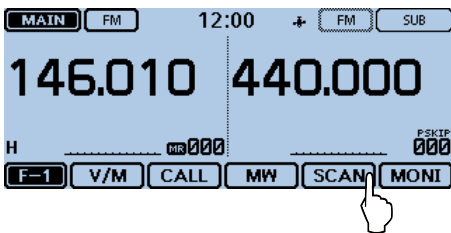

- ⑤ Touch the desired scan type.
 - ALL: Full scan
 - BAND: Band memory scan
 - MODE: Mode memory scan
 - DUP: Duplex scan (p. 4-2)
(Appears only when duplex is set.)
 - TONE: Tone scan
(For tone squelch scanning)

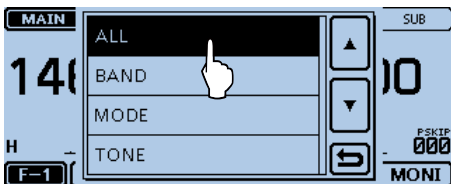

- ⑥ The scan starts.
 - If desired, rotate [DIAL] during a scan to switch the scanning direction.
 - The scan runs even while the Menu or Quick Menu screen is displayed.

During a Memory scan

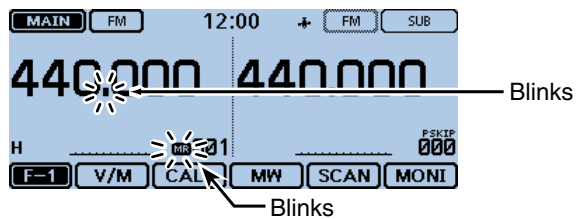

When receiving a signal

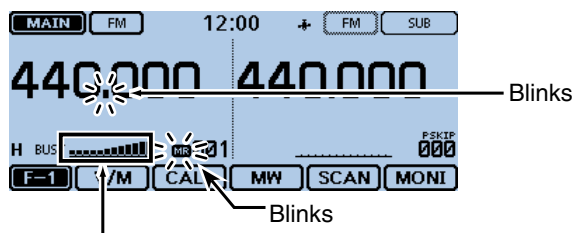

The S-meter shows the received signal strength.

- ⑦ To cancel the scan, touch [SCAN].
 - Touching the frequency readout also cancels the scan.

Memory scan (Continued)

◇ Memory bank scan

A memory bank scan searches through the memory channels in the selected bank.

- Two or more memory channels, which are not set as skip channels, must be programmed to start a memory bank scan.
- When the “Bank Select” item in the Quick Menu screen is set to “OFF,” a bank scan is not started.

- ① Touch the Memory channel number.
 - Opens the Mode setting window.
- ② Touch [MR].
 - Selects the Memory mode.
- ③ Touch the Function group icon one or more times.
 - Selects the F-1 menu.
- ④ Touch [SCAN].
 - Opens the scan type setting window.

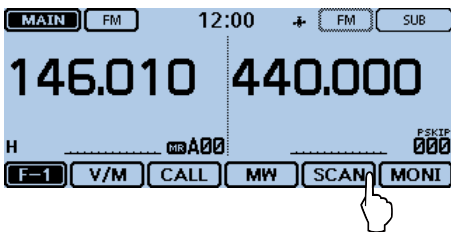

- ⑤ Touch the desired scan type.
 - ALL: Full bank scan
 - BANK-LINK: Bank link scan
 - BANK-A to Z: Bank scan
(Only banks which contain a memory channel are displayed.)
 - DUP: Duplex scan (p. 4-2)
(Appears only when duplex is set on the channel.)
 - TONE: Tone scan (For tone scanning)

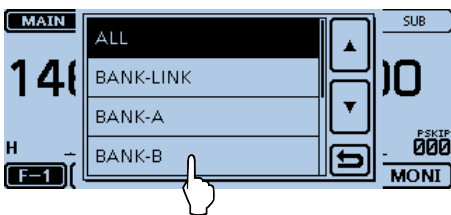

- ⑥ The scan starts.
 - If desired, during a scan, rotate [DIAL] to switch the scanning direction.
 - The scan runs even while the Menu or Quick Menu screen is displayed.

During a Memory bank scan

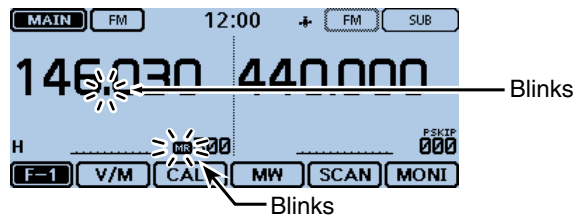

When receiving a signal

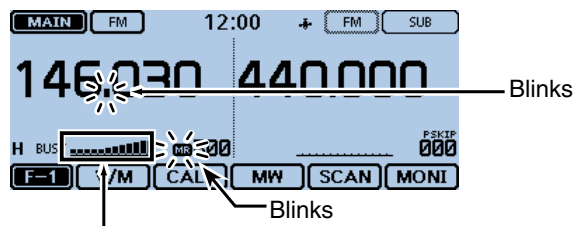

The S-meter shows the received signal strength.

- ⑦ To cancel the scan, touch [SCAN].
 - Touching the frequency readout also cancels the scan.

When a bank name is assigned.

When a bank name is assigned, the bank name is displayed on the scan type setting window.

NOTE: The scan name is not displayed during a scan.

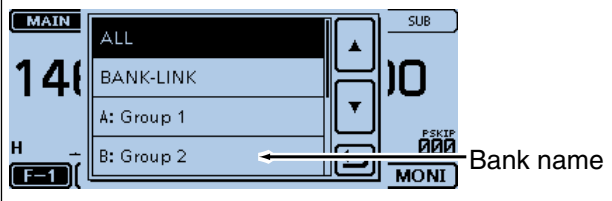

NOTE:

- When all channels are set as “SKIP” or “PSKIP,” the bank will be skipped during a bank link scan.
- When all channels in the selected bank are set as “SKIP” or “PSKIP,” the scan does not start during a bank scan.

Setting and clearing the skip channel

The channels set as “SKIP” or “PSKIP” skip channels are skipped (not scanned).

See page 4-7 for details of clearing the skip setting.

Example: Set “SKIP” to Memory channel “000.”

- ① Touch the Memory channel number.
 - Opens the Mode setting window.
- ② Touch [MR].
 - Selects the Memory mode.
- ③ Rotate [DIAL] to select the memory channel 000.

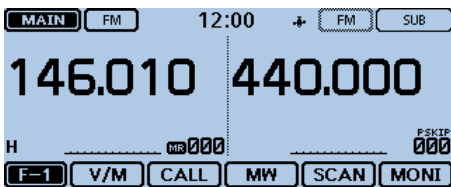

- ④ Touch the Function group icon one or more times.
 - Selects the F-2 menu.
- ⑤ Touch [SKIP].
 - Open the skip setting window.

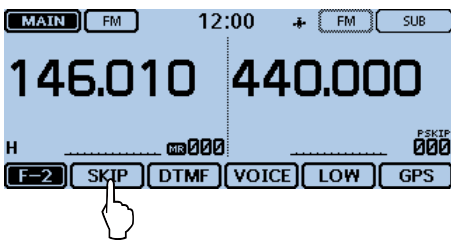

- ⑥ Touch “SKIP.”
 - OFF : Cancel the skip setting.
 - SKIP : Skipped during a memory scan.
 - PSKIP : Skipped during both VFO and memory scans.

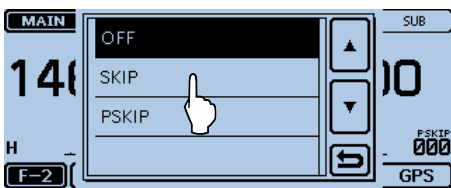

The skip setting is set.

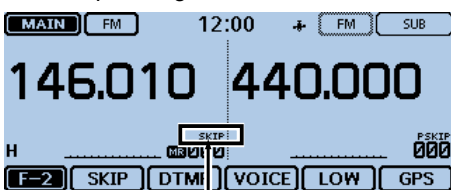

“SKIP” appears

To clear the skip setting, select “OFF” in step ⑥.

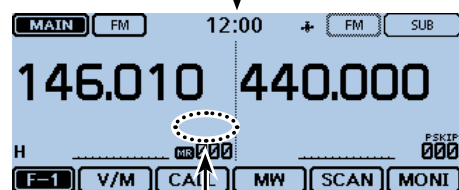
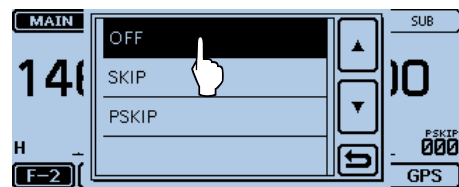

“SKIP” or “PSKIP” disappears.

Setting the temporary skip function

This function temporarily skips up to five unwanted frequencies during a scan, for the set time period.

This function enables you to temporarily skip the unwanted frequencies without the skip frequency setting.

- ① Start the scan. (p. 4-5)
 - When a signal is received, the scan pauses.
- ② While the scan is paused, and if you want to skip the frequency, touch [QUICK].
- ③ Touch “Temporary Skip.”

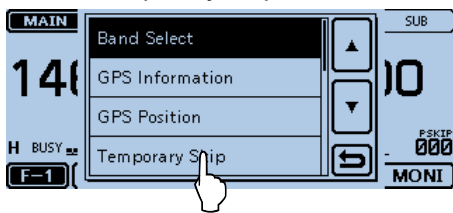

- The Temporary skip function is set.

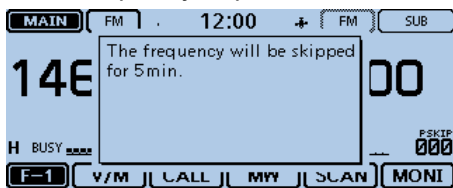

- ④ After setting the temporary skip function, the scan resumes.
 - The frequency will be skipped for the Temporary Skip time period.
 - After the Temporary Skip time period passes, or the scan is cancelled, the Temporary Skip is also cancelled.

- ▨ The Temporary Skip time period is set to “5 minutes” by default.
- ▨ You can change the setting in the Menu screen. (Scan > **Temporary Skip Timer**)

For your reference:

- Up to five Temporary Skip frequencies or memories can be set. When the 6th frequency or memory is set, the message window appears, and the oldest frequency or memory is automatically deleted.

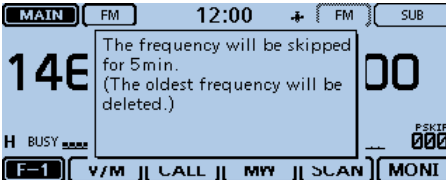

- During Memory or DR scanning, follow steps ② and ③ to skip the channel for the set time period (Default: 5 minutes).
- The Temporary Skip time period is set to “5 minutes” by default. You can change the setting in the Menu screen. (Scan > **Temporary Skip Timer**)

Entering scan edges

You can enter the upper and lower frequency edges to the program scan edge ranges for programmed scans. Each program scan edge range has its own tuning step and the receive mode.

The default setting is differ, depending on the transceiver's version.

You can enter a total of up to 25 program scan edge ranges.

- ① Touch [MENU].
- ② Touch "Program Scan Edge."
(Scan > Program Scan Edge)
 - If the item is not displayed, touch [▲] or [▼] one or more times to select another page.

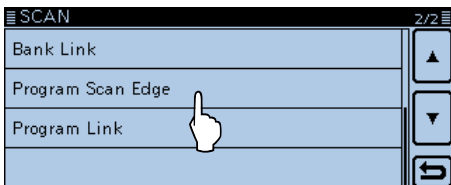

- ③ Touch [▲] or [▼] one or more times.
 - Selects a desired scan edge channel.
- ④ Touch the scan edge channel for 1 second.

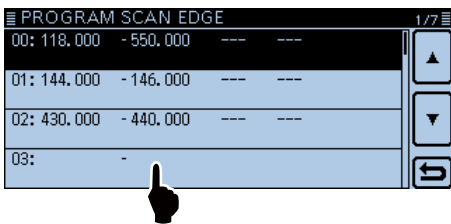

- ⑤ Touch [Edit].
 - Opens the "PROGRAM SCAN EDGE" screen.

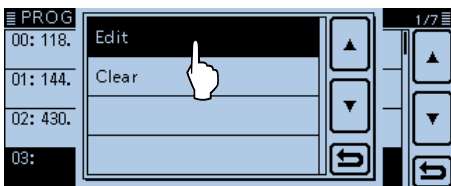

- ⑥ Touch [NAME].

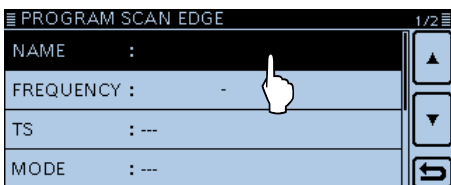

- ⑦ Touch the keypad.
 - Enters the desired character or symbol.
 - In the Alphabet entry mode, touch "↑" to enter an upper case letter once, or touch "↑" to continuously enter upper case letters. Touch "↕" to enter lower case letters.
 - Touch [[ab]] or [[12]], and then touch [ab], [12] or [(!#)] to select the desired entry mode.

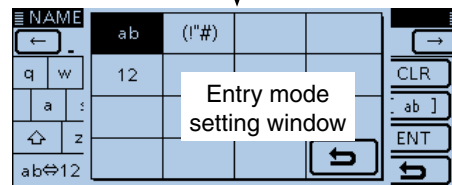
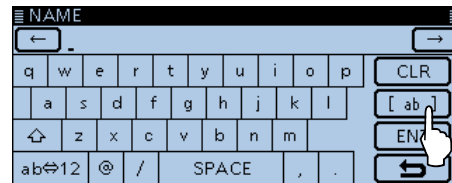

- Touch "ab↔12" to toggle between the Alphabet entry and Number entry modes.
- Touch "SPACE" to enter a space.
- Touch [CLR] to delete the selected character, symbol or number.
- Touch [QUICK], and then touch "Switch to Tenkey" to switch the keyboard type.

Selectable characters and symbols
A to Z, a to z, 0 to 9, ! " # \$ % & ' () * + , - . / : ; < = > ? @ [\] ^ _ ` { } ~ (space)

- ⑧ Touch [←] to move the cursor backwards, or touch [→] to move the cursor forwards.
- ⑨ Repeat steps ⑨ and ⑩ to enter a name of up to 16 characters, including spaces.
- ⑩ After entering, touch [ENT].

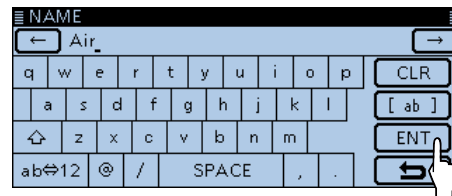

- ⑪ Touch [FREQUENCY].

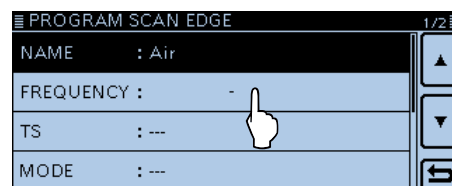

Entering scan edges (Continued)

- ⑫ Enter a lower frequency. (Example: 118000)
- Touch [←] to move the cursor backwards, or touch [→] to move the cursor forwards.
 - Touch [CE] to clear the entered number.
 - After entering a MHz digit, touch [◀ ▶] to automatically enter '000.'
 - Some frequencies cannot be entered.

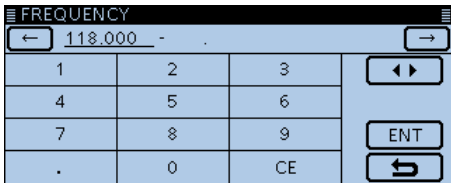

- ⑬ After entering a lower frequency, touch [◀ ▶].
- The cursor moves to a MHz digit of the higher frequency.

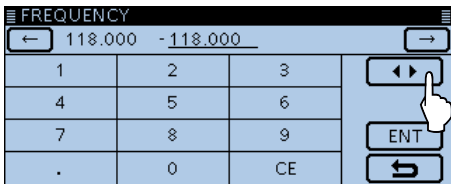

- ⑭ Enter a higher frequency, and then touch [ENT]. (Example: 136000)

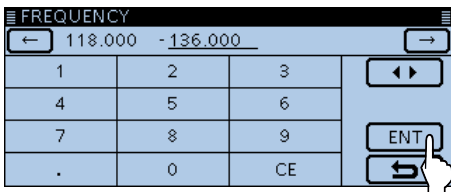

- ⑮ Touch "TS."

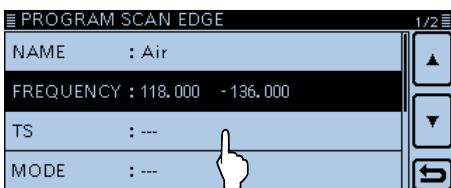

- ⑯ Touch the desired tuning step to be used while program scanning.

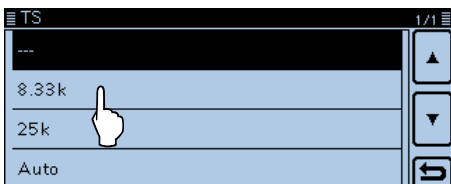

- ⑰ Touch "MODE."
- Displays the selectable mode.

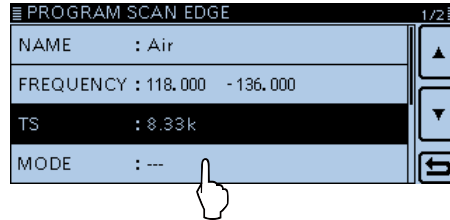

- ⑱ Touch the desired receive mode to be used while program scanning.
- When you select "---," the receive mode set in the VFO mode is used during a scan.

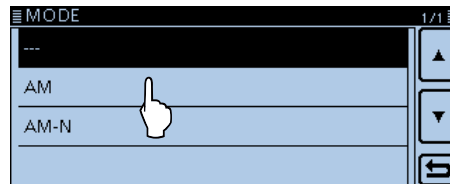

- ⑲ Touch [▼].
- ⑳ Touch "<<Write>>."

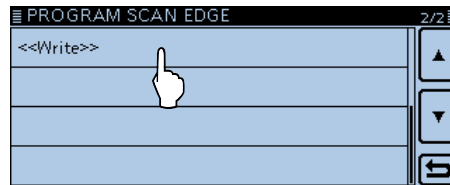

- ㉑ Touch [YES].
- Displays the entered content in the "???" screen.

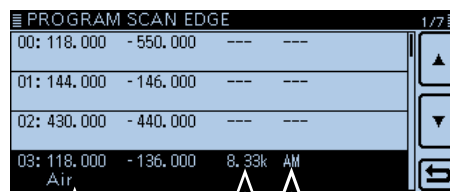
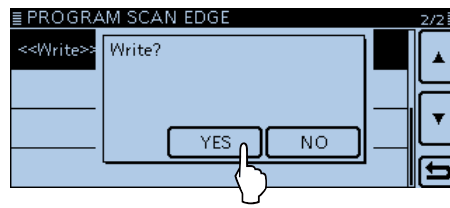

Scan name Tuning step Receive mode

Priority watch.....	5-2
◇ VFO frequency and a priority channel.....	5-2
◇ VFO frequency and a Memory/Bank scan	5-2
◇ VFO scan and a priority channel.....	5-2
◇ VFO scan and a Memory/Bank scan.....	5-2
◇ A frequency in “FROM” on the DR screen and a priority channel.....	5-3
◇ DR scan and a priority channel.....	5-3
VFO frequency and a priority channel.....	5-4
VFO frequency and a Memory/Bank scan.....	5-6
VFO scan and a priority channel.....	5-8
VFO scan and a Memory/Bank scan.....	5-10
A frequency in “FROM” on the DR screen and a priority channel.....	5-12
DR scan and a priority channel.....	5-16

Priority watch

While operating on a VFO frequency, DR function or while scanning, Priority watch checks for signals on a selected frequency every 5 seconds.

While in the Dualwatch mode, Priority watch can be activated on both the MAIN and SUB band.

When the DV signal is simultaneously received on both MAIN and SUB band, the SUB band audio signal is muted.

◇ VFO frequency and a priority channel

(p. 5-4)

Checks the selected priority channel every 5 seconds, while receiving on a VFO frequency.

A Memory channel, Bank channel or Call channel can be selected as the priority channel

• VFO frequency and a Memory channel

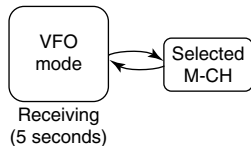

• VFO frequency and a Bank channel

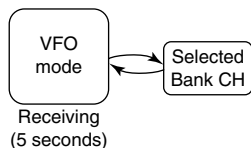

• VFO frequency and a Call channel

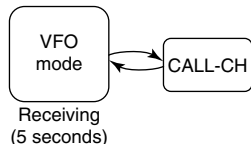

◇ VFO scan and a priority channel

(p. 5-8)

Checks the selected priority channel every 5 seconds, during a VFO mode scan.

A Memory channel, Bank channel or Call channel can be selected as the priority channel

• VFO scan and a Memory channel

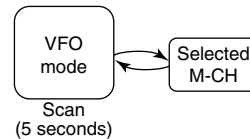

• VFO scan and a Bank channel

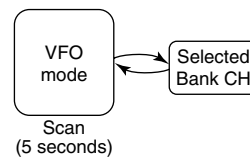

• VFO scan and a Call channel

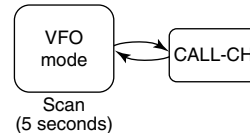

◇ VFO frequency and a Memory/Bank scan

(p. 5-6)

Sequentially checks the Memory or Bank channels every 5 seconds, while receiving on a VFO frequency.

A Memory scan or Bank scan can be selected.

• VFO frequency and a Memory scan

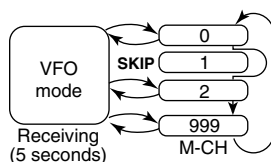

• VFO frequency and a Bank scan

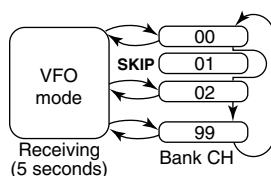

◇ VFO scan and a Memory/Bank scan

(p. 5-10)

Sequentially checks the Memory or Bank channels every 5 seconds during a VFO mode scan.

A Memory scan or Bank scan can be selected.

• VFO scan and a Memory scan

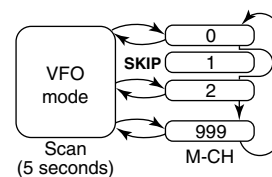

• VFO scan and a Bank scan

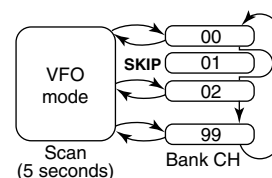

Priority watch (Continued)

◇ A frequency in “FROM” on the DR screen and a priority channel

(p. 5-12)

Checks a priority channel every 5 seconds while receiving on a repeater or simplex frequency set in “FROM” on the DR screen.

A VFO frequency, Memory channel, Bank channel or Call channel can be selected as the priority channel

• “FROM” on the DR screen and a VFO frequency

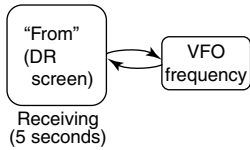

• “FROM” on the DR screen and a Memory channel

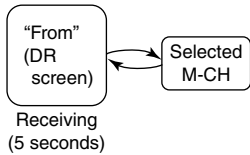

• “FROM” on the DR screen and a Bank channel

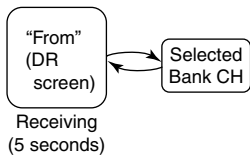

• “FROM” on the DR screen and a Call channel

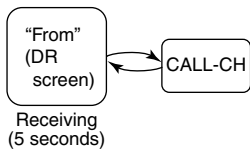

◇ DR scan and a priority channel

(p. 5-16)

Checks a priority channel every 5 seconds, during a DR scan.

A VFO frequency, Memory channel, Bank channel or Call channel can be selected as the priority channel

• DR scan and a VFO frequency

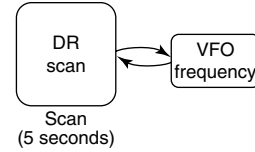

• DR scan and a Memory channel

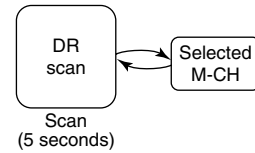

• DR scan and a Bank channel

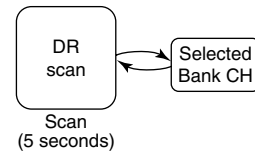

• DR scan and a Call channel

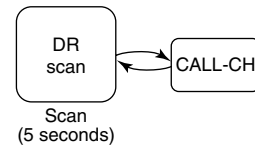

VFO frequency and a priority channel

Checks the selected priority channel every 5 seconds, while receiving on a VFO frequency.

1. Set the VFO frequency

- 1 Touch the Memory channel number.
 - Opens the Mode setting window.
- 2 Touch [VFO].
- 3 Set the receive frequency and mode.

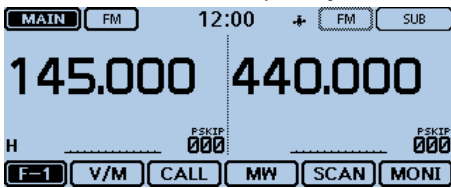

2. Set the priority channel

• To select a Memory channel

- 1 Touch the Memory channel number.
 - Opens the Mode setting window.
- 2 Touch [MR].
- 3 Rotate [DIAL] to select the Memory channel you want to watch.

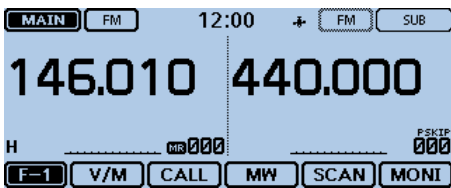

• To select a Bank channel

- 1 In the Memory channel mode, touch the Memory channel number.
 - Opens the Mode setting window.
- 2 Touch [BANK].
- 3 Rotate [DIAL] to select the Bank channel you want to watch.

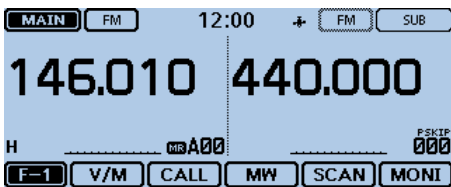

How to select the Memory and Bank:

- 1 In the Memory mode, touch [QUICK].
- 2 Touch "Bank Select."
 - The Bank list is displayed.
- 3 Touch a desired bank.
 - If "OFF" is selected, cancel the bank selection.

• To select a Call channel

- 1 Touch the Memory channel number.
 - Opens the Mode setting window.
- 2 Touch [CALL].
- 3 Rotate [DIAL] to select the Call channel you want to watch.

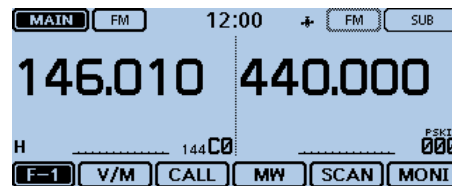

3. Start the Priority watch

- 1 Touch [QUICK].
- 2 Touch "PRIO Watch."

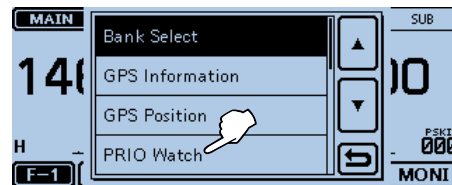

- 3 Touch "ON" or "Bell."
 - ON: When a signal is received on the priority channel, the channel is automatically selected.
 - Bell: When a signal is received on the priority channel, the "(•)" icon is displayed in the VFO screen.
- 4 The Priority watch starts.
 - The "PRIO" icon appears.

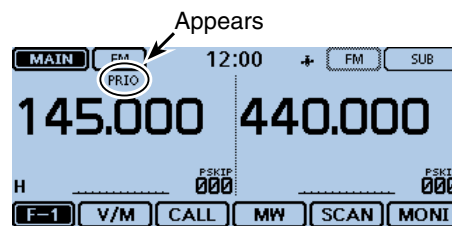

To cancel the Priority watch:

Touch [QUICK], and then touch "PRIO Watch OFF."

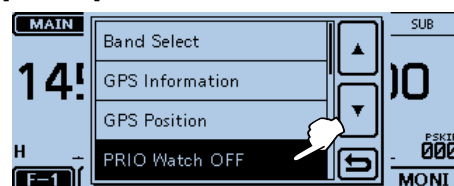

Continued on the next page.

VFO frequency and a priority channel (Continued)

4. During a Priority watch

Checks the selected priority channel every 5 seconds, while receiving on a VFO frequency.

Example: Checks Memory channel "000" while receiving on 145.000 MHz.

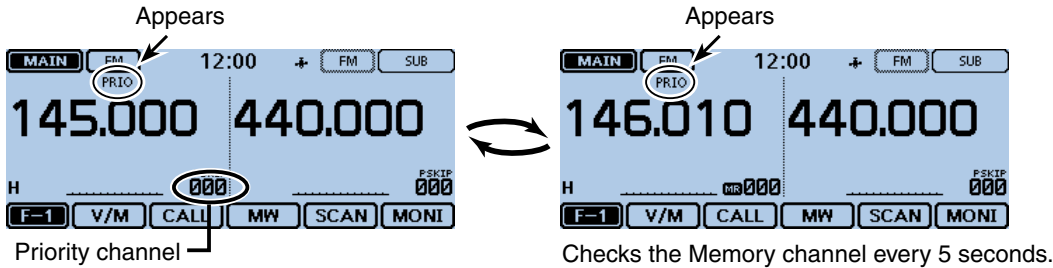

Example: Checks Bank channel "A00" while receiving on 145.000 MHz.

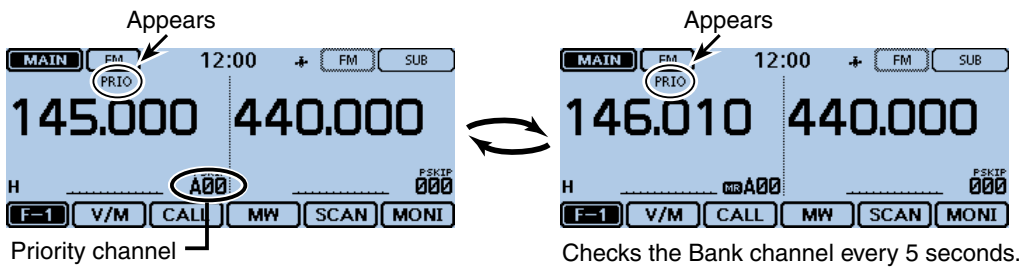

Example: Checks Call channel "C0 (144)" while receiving on 145.000 MHz.

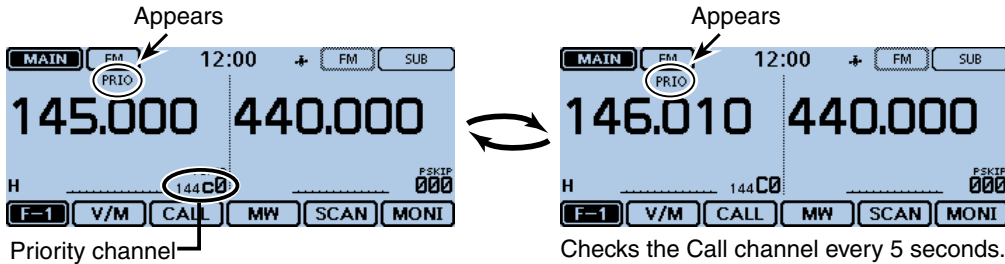

5. When a signal is received

• When "ON" is selected.

When a signal is received on the priority channel, the channel is automatically selected. The "PRIO" icon blinks on the screen.
 - The scan pause timer and resume settings are the same as for a normal scan. (p. 12-14)

• When "Bell" is selected.

When a signal is received on the priority channel, a beep sounds and the "(•)" icon blinks on the screen.

Example: For a Memory channel

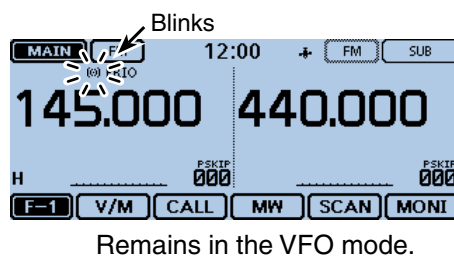
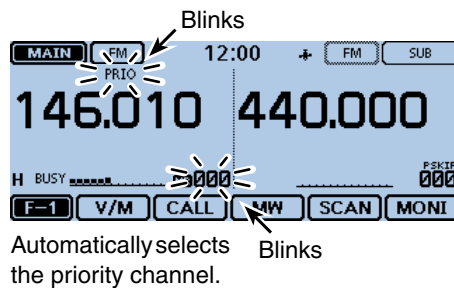

VFO frequency and a Memory/Bank scan

Sequentially checks the Memory or Bank channels every 5 seconds, while receiving on a VFO frequency.

1. Set the VFO frequency

- 1 Touch the Memory channel number.
 - Opens the Mode setting window.
- 2 Touch [VFO].
- 3 Set the receive frequency and mode.

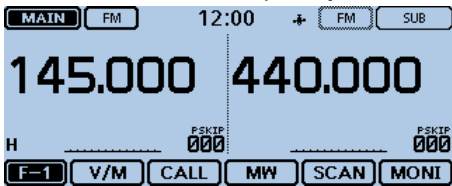

2. Start a Memory or Bank scan

•To start a Memory scan

- 1 Touch the Memory channel number.
 - Opens the Mode setting window.
- 2 Touch [MR].
- 3 Touch the Function group icon one or more times.
 - Selects the F-1 menu.
- 4 Touch [SCAN].
 - Open the scan type setting window.
- 5 Touch the desired scan type.
 - The Memory scan starts.

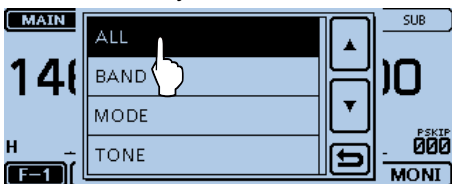

•To start a Bank scan

- 1 Touch the Memory channel number.
 - Opens the Mode setting window.
- 2 Touch [MR].
- 3 Touch the Function group icon one or more times.
 - Selects the F-1 menu.
- 4 Touch [SCAN].
 - Open the scan type setting window.
- 5 Touch the desired scan type.
 - The Bank scan starts.

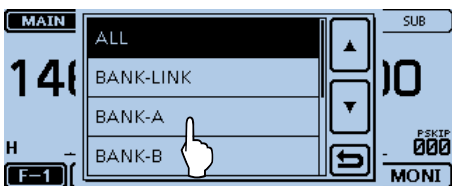

How to select the Memory and Bank:

- 1 In the Memory mode, touch [QUICK].
- 2 Touch "Bank Select."
 - The Bank list is displayed.
- 3 Touch a desired bank.
 - If "OFF" is selected, cancel the bank selection.

3. Start the Priority watch

- 1 Touch [QUICK].
- 2 Touch "PRIO Watch."

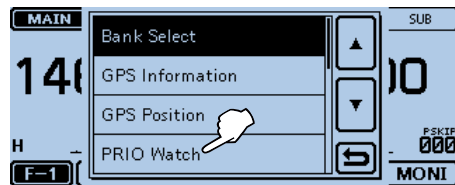

- 3 Touch "ON" or "Bell."
 - ON: When a signal is received on the priority channel, the channel is automatically selected.
 - Bell: When a signal is received on the priority channel, the "(•)" icon is displayed in the VFO screen.
- 4 The Priority watch starts.
 - The "PRIO" icon appears.

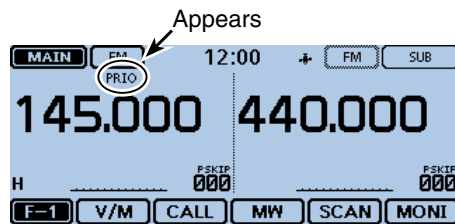

To cancel the Priority watch:

- Touch [QUICK], and then touch "PRIO Watch OFF".
- The Memory or Bank scan is also cancelled.

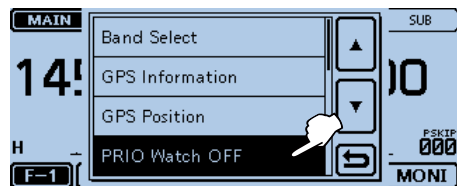

Continued on the next page.

VFO frequency and a Memory/Bank scan (Continued)

4. During a Priority watch

Sequentially checks the Memory or Bank channels every 5 seconds, while receiving on a VFO frequency.

Example: Sequentially checks the Memory channels while receiving on 145.000 MHz.

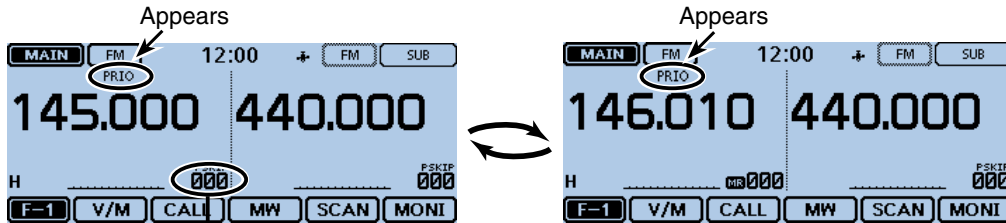

The Memory channels are sequentially checked.

Checks the Memory channels every 5 seconds.

Example: Sequentially checks Bank channels while receiving on 145.000 MHz.

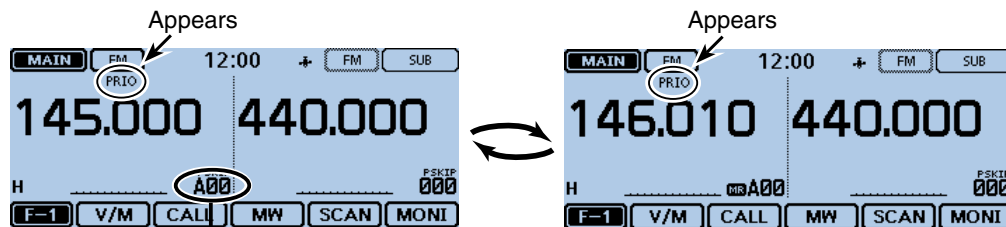

The bank channels are sequentially selected.

Checks the Bank channels every 5 seconds.

5. When a signal is received

• When "ON" is selected.

When a signal is received on the priority channel, the channel is automatically selected.

The "PRIO" icon blinks on the screen.

- The scan pause timer and resume settings are the same as for a normal scan. (p. 12-14)

Example: For a Memory scan

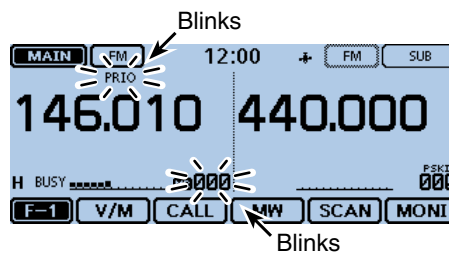

Automatically selects the Memory channel.

• When "Bell" is selected.

When a signal is received on the priority channel, a beep sounds and the "(•)" icon blinks on the screen.

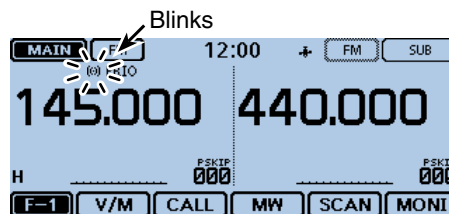

Remains in the VFO mode.

VFO scan and a priority channel

Checks the selected priority channel every 5 seconds, during a VFO mode scan.

1. Set the priority channel

• To select a Memory channel

- 1 Touch the Memory channel number.
 - Opens the Mode setting window.
- 2 Touch [MR].
- 3 Rotate [DIAL] to select the Memory channel you want to watch.

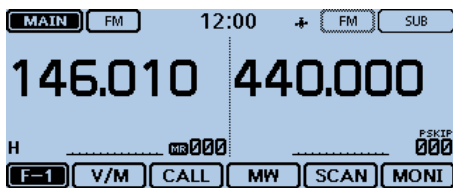

• To select a Bank channel

- 1 Touch the Memory channel number.
 - Opens the Mode setting window.
- 2 Touch [MR].
- 3 Rotate [DIAL] to select the Bank channel you want to watch.

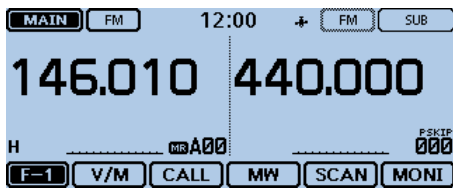

How to select the Memory and Bank:

- 1 In the Memory mode, touch [QUICK].
- 2 Touch "Bank Select."
 - The Bank list is displayed.
- 3 Touch a desired bank.
 - If "OFF" is selected, cancel the bank selection.

• To select a Call channel

- 1 Touch the Memory channel number.
 - Opens the Mode setting window.
- 2 Touch [CALL].
- 3 Rotate [DIAL] to select the Call channel you want to watch.

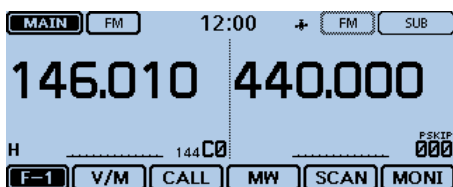

2. Start the Priority watch

- 1 Touch [QUICK].
- 2 Touch "PRIO Watch."
 - Touch "ON" or "Bell."
 - ON: When a signal is received on the priority channel, the channel is automatically selected.
 - Bell: When a signal is received on the priority channel, the "(•)" icon is displayed in the VFO screen.
- 3 Touch "ON" or "Bell."
 - The Priority watch starts.
 - The "PRIO" icon appears.

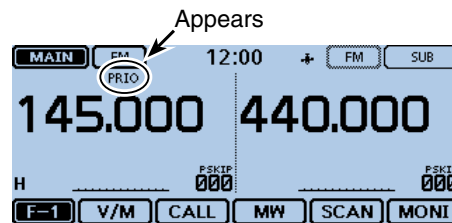
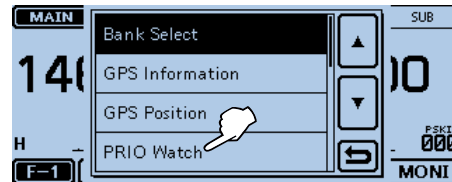

3. Start the VFO scan

- 1 Touch the Function group icon one or more times.
 - Selects the F-1 menu.
- 2 Touch [SCAN].
 - Open the scan type setting window.
- 3 Touch the desired scan type.
 - The VFO scan starts.

To cancel the Priority watch:

Touch [QUICK], and then touch "PRIO Watch OFF."

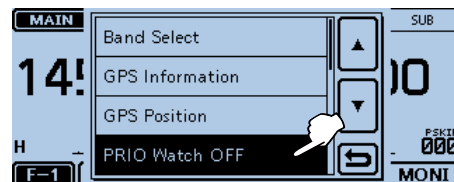

- In this case, the VFO scan is not cancelled. To cancel the VFO scan, touch [SCAN].

VFO scan and a priority channel (Continued)

4. During a Priority watch

Checks the selected priority channel every 5 seconds, while VFO scanning.

Example: Checks Memory channel "000" while VFO scanning

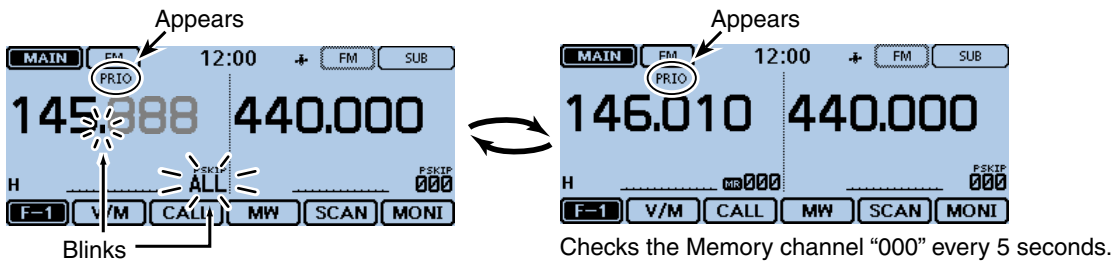

Example: Checks Bank channel "A00" while VFO scanning

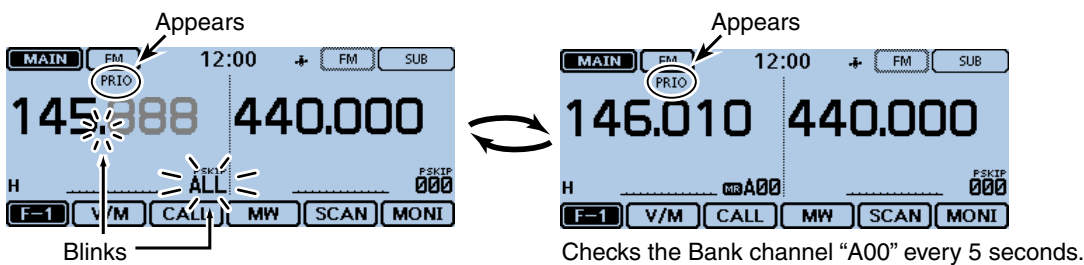

Example: Checks Call channel "C0 (144)" while VFO scanning

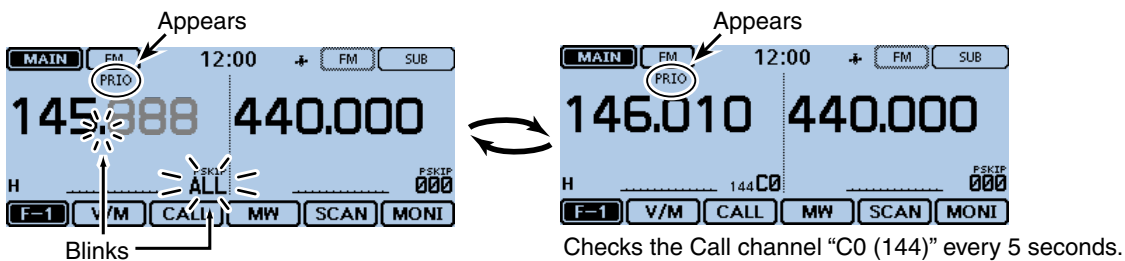

5. When a signal is received.

• When "ON" is selected.

When a signal is received on the priority channel, the channel is automatically selected. The "PRIO" icon blinks.
 * The scan pause timer and resume settings are the same as for a normal scan. (p. 12-14)

Example: For a Memory channel

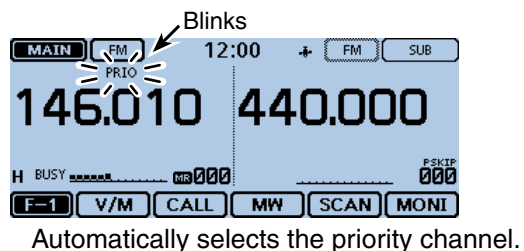

• When "Bell" is selected.

When a signal is received on the priority channel, a beep sounds and the "((•))" icon blinks. The VFO scan resumes.

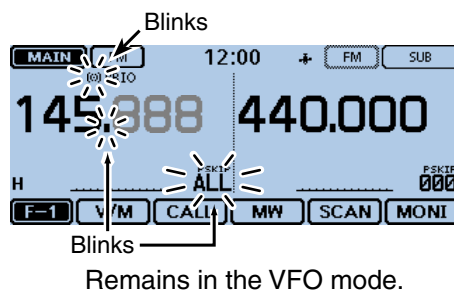

VFO scan and a Memory/Bank scan

Sequentially checks the Memory or Bank channels every 5 seconds during a VFO scan.

1. Start the Memory or Bank scan

• To start a Memory scan

- 1 Touch the Memory channel number.
 - Opens the Mode setting window.
- 2 Touch [MR].
- 3 Touch the Function group icon one or more times.
 - Selects the F-1 menu.
- 4 Touch [SCAN].
 - Open the scan type setting window.
- 5 Touch the desired scan type.
 - The Memory scan starts.

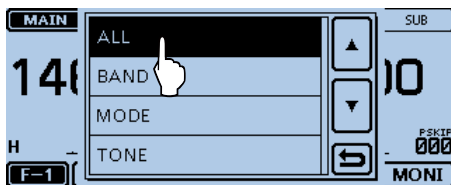

• To start a Bank scan

- 1 Touch the Memory channel number.
 - Opens the Mode setting window.
- 2 Touch [MR].
- 3 Touch the Function group icon one or more times.
 - Selects the F-1 menu.
- 4 Touch [SCAN].
 - Open the scan type setting window.
- 5 Touch the desired scan type.
 - The Memory bank scan starts.

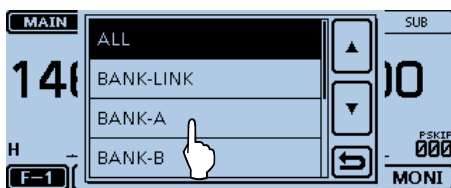

How to select the Memory and Bank:

- 1 In the Memory mode, touch [QUICK].
- 2 Touch "Bank Select."
 - The Bank list is displayed.
- 3 Touch a desired bank.
 - If "OFF" is selected, cancel the bank selection.

2. Start the Priority watch

- 1 Touch [QUICK].
- 2 Touch "PRIO Watch."
 - ON: When a signal is received on the priority channel, the channel is automatically selected.
 - Bell: When a signal is received on the priority channel, the "(•)" icon is displayed in the VFO screen.
- 3 Touch "ON" or "Bell."
 - ON: When a signal is received on the priority channel, the channel is automatically selected.
 - Bell: When a signal is received on the priority channel, the "(•)" icon is displayed in the VFO screen.
- 4 The Priority watch starts.
 - The "PRIO" icon appears.

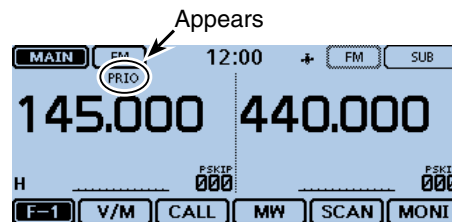
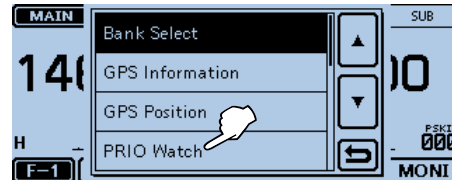

3. Start the VFO scan

- 1 Touch the Function group icon one or more times.
 - Selects the F-1 menu.
- 2 Touch [SCAN].
 - Open the scan type setting window.
- 3 Touch the desired scan type.
 - The VFO scan starts.

To cancel the Priority watch:

Touch [QUICK], and then touch "PRIO Watch OFF."

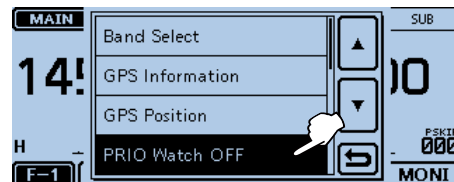

- In this case, the VFO scan is not cancelled. To cancel the VFO scan, touch [SCAN].

VFO scan and a Memory/Bank scan (Continued)

4. During a Priority watch

Checks the selected priority channel every 5 seconds, while VFO scanning.

Example: Checks the Memory channels every 5 seconds while VFO scanning

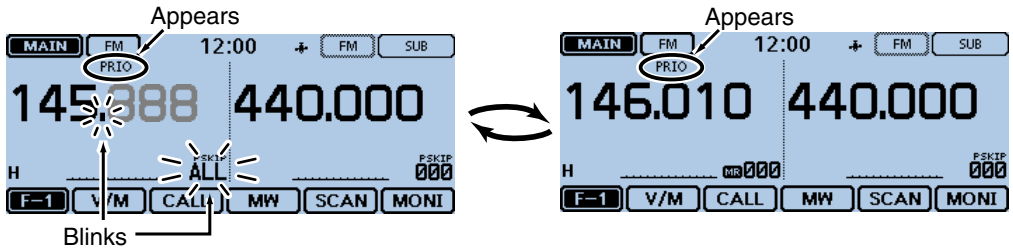

Example: Checks the Bank channels every 5 seconds while VFO scanning

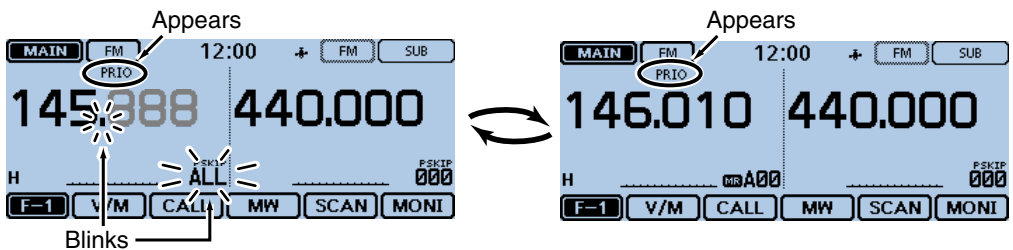

5. When a signal is received.

• When "ON" is selected.

When a signal is received on the priority channel, the channel is automatically selected. The "PRIO" icon blinks.
 * The scan pause timer and resume settings are the same as for a normal scan. (p. 12-14)

Example: For a Memory scan

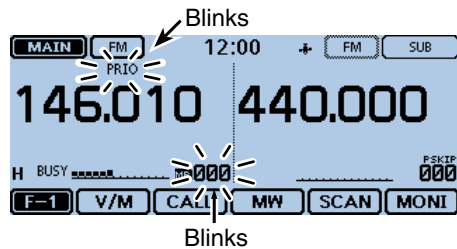

Automatically selects the Memory channel.

• When "BELL" is selected.

When a signal is received on the priority channel, a beep sounds and the "(•)" icon blinks. The VFO scan resumes.

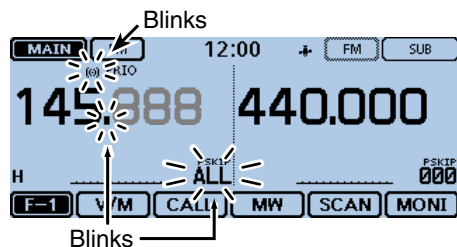

Remains in the VFO mode.

A frequency in "FROM" on the DR screen and a priority channel

Checks the selected priority channel every 5 seconds, while receiving a repeater or simplex frequency in "FROM" of the DR screen.

1. Set the priority channel

• To select a VFO frequency

- 1 Touch the Memory channel number.
 - Opens the Mode setting window.
- 2 Touch [VFO].
- 3 Set the receive frequency and mode.

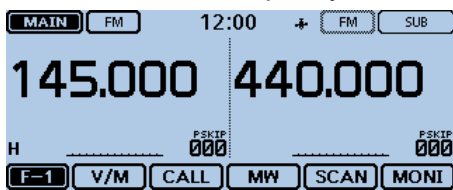

• To select a Memory channel

- 1 Touch the Memory channel number.
 - Opens the Mode setting window.
- 2 Touch [MR].
- 3 Rotate [DIAL] to select the Memory channel you want to watch.

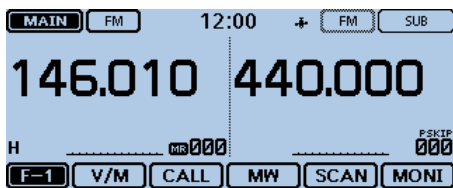

• To select a Bank channel

- 1 Touch the Memory channel number.
 - Opens the Mode setting window.
- 2 Touch [MR].
- 3 Rotate [DIAL] to select the Bank channel you want to watch.

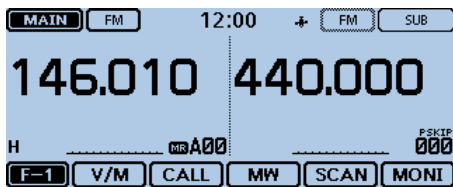

How to select the Memory and Bank:

- 1 In the Memory mode, touch [QUICK].
- 2 Touch "Bank Select."
 - The Bank list is displayed.
- 3 Touch a desired bank.
 - If "OFF" is selected, cancel the bank selection.

• To select a Call channel

- 1 Touch the Memory channel number.
 - Opens the Mode setting window.
- 2 Touch [CALL].
- 3 Rotate [DIAL] to select the Call channel you want to watch.

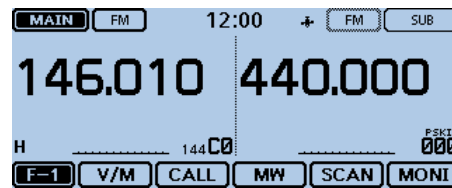

2. Select the repeater or simplex frequency in the DR screen

- 1 Touch [DR].
 - Turns ON the DR function.
- 2 Touch the "FROM" field.
- 3 Rotate [DIAL] to select the desired repeater or a simplex frequency.

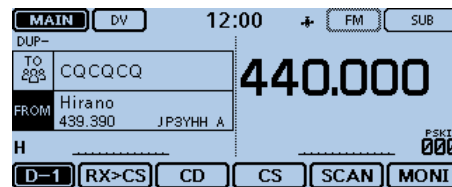

A frequency in "FROM" on the DR screen and a priority channel (Continued)

3. Start a Priority watch

- 1 Touch [QUICK].
- 2 Touch "PRIO Watch."

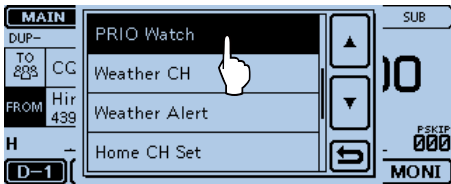

- 3 Touch "ON" or "Bell."
 - ON: When a signal is received on the priority channel, the channel is automatically selected.
 - Bell: When a signal is received on the priority channel, the "((·))" icon is displayed in the VFO mode.
- 4 The Priority watch starts.
 - The "PRIO" icon appears.

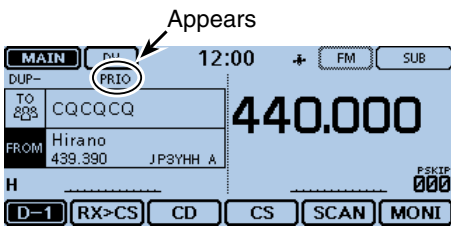

To cancel the Priority watch:
 Touch [QUICK], and then touch "PRIO Watch OFF."

A frequency in "FROM" on the DR screen and a priority channel (Continued)

4. During a Priority watch

Checks the selected priority channel every 5 seconds, while receiving on a repeater or a simplex frequency in the DR screen.

Example: Checks the VFO frequency every 5 seconds while receiving on a repeater or a simplex frequency.

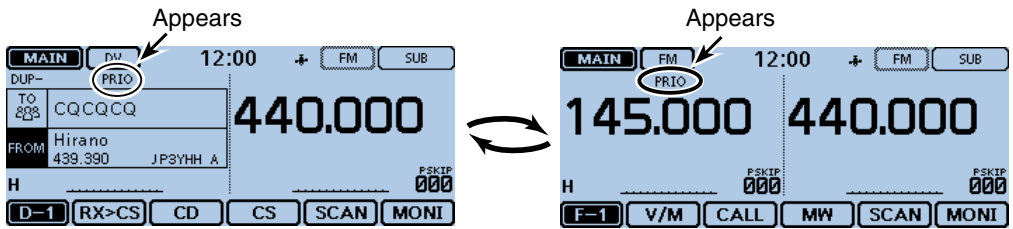

Example: Checks the Memory channel "000" every 5 seconds while receiving on a repeater or a simplex frequency.

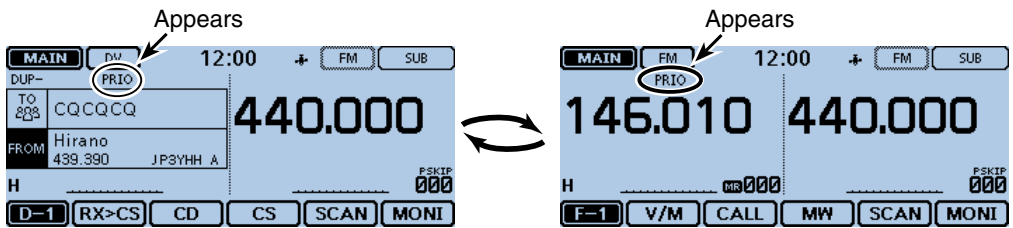

Example: Checks the Bank channel "A00" every 5 seconds while receiving on a repeater or a simplex frequency.

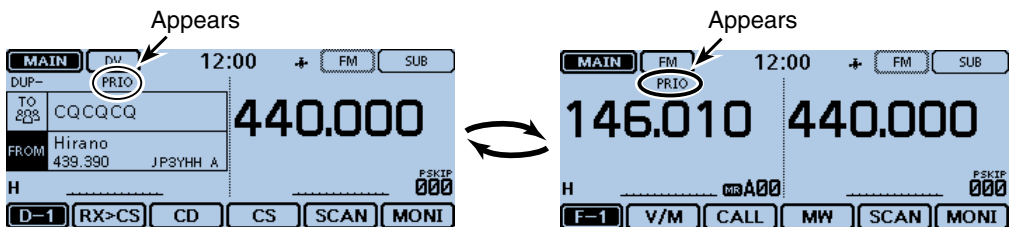

Example: Checks the Call channel "C0 (144)" every 5 seconds while receiving on a repeater or a simplex frequency.

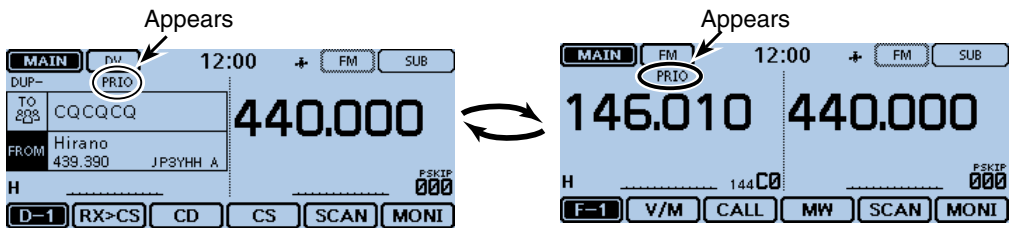

A frequency in "FROM" on the DR screen and a priority channel (Continued)

5. When a signal is received.

• When "ON" is selected.

When a signal is received on the priority channel, the channel is automatically selected.

The "PRIO" icon blinks.

* The scan pause timer and resume settings are the same as for a normal scan. (p. 12-14)

Example: For a Memory channel

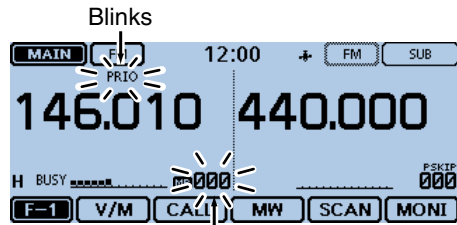

Blinks
Automatically selects the priority channel.

• When "Bell" is selected.

When a signal is received on the priority channel, a beep sounds and the "(•)" icon blinks on the screen.

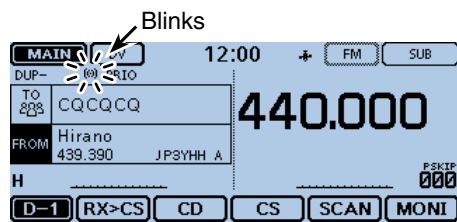

Blinks
Remains in the DR screen.

DR scan and a priority channel

Checks the selected priority channel every 5 seconds, during a DR scan.

1. Set the priority channel

•To select a VFO frequency

- 1 Touch the Memory channel number.
 - Opens the Mode setting window.
- 2 Touch [VFO].
- 3 Set the receive frequency and mode.

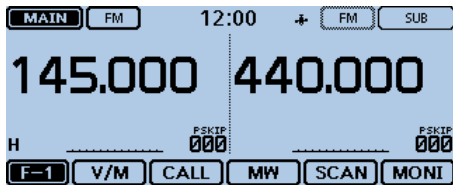

•To select a Memory channel

- 1 Touch the Memory channel number.
 - Opens the Mode setting window.
- 2 Touch [MR].
- 3 Rotate [DIAL] to select the Memory channel you want to watch.

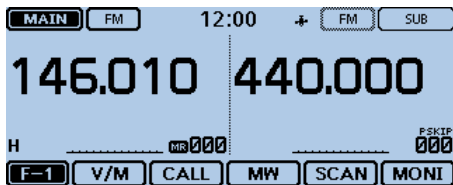

•To select a Bank channel

- 1 Touch the Memory channel number.
 - Opens the Mode setting window.
- 2 Touch [MR].
- 3 Rotate [DIAL] to select the Bank channel you want to watch.

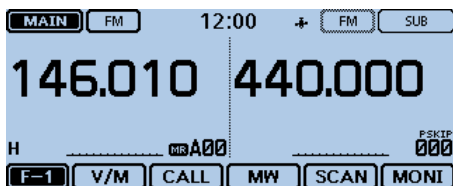

How to select the Memory and Bank:

- 1 In the Memory mode, touch [QUICK].
- 2 Touch "Bank Select."
 - The Bank list is displayed.
- 3 Touch a desired bank.
 - If "OFF" is selected, cancel the bank selection.

•To select a Call channel

- 1 Touch the Memory channel number.
 - Opens the Mode setting window.
- 2 Touch [CALL].
- 3 Rotate [DIAL] to select the Call channel you want to watch.

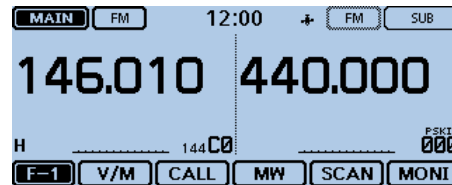

2. Start the DR scan

- 1 Touch [DR].
 - Turns ON the DR function.
- 2 Touch [SCAN].
 - Open the scan type setting window.
- 3 Touch the desired scan type.
 - The DR scan starts.

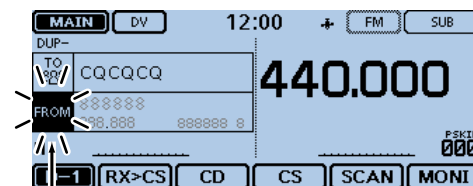

Blinks

DR scan and a priority channel (Continued)

3. Start the Priority watch

- 1 Touch [QUICK].
- 2 Touch "PRIO Watch."

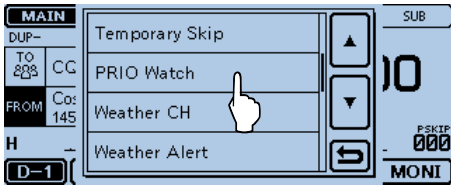

- 3 Touch "ON" or "Bell."
 - ON: When a signal is received on the priority channel, the channel is automatically selected.
 - Bell: When a signal is received on the priority channel, the "(•)" icon is displayed in the screen.
- 4 The Priority watch starts.
 - The "PRIO" icon appears.

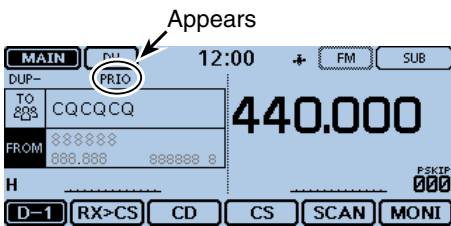

To cancel the Priority watch:
Touch [QUICK], and then touch "PRIO Watch OFF."

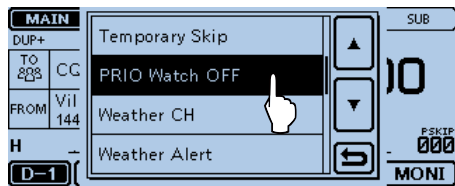

DR scan and a priority channel (Continued)

4. During a Priority watch

Checks the selected priority channel every 5 seconds, during a DR scan.

Example: Checks the VFO frequency during the DR scan.

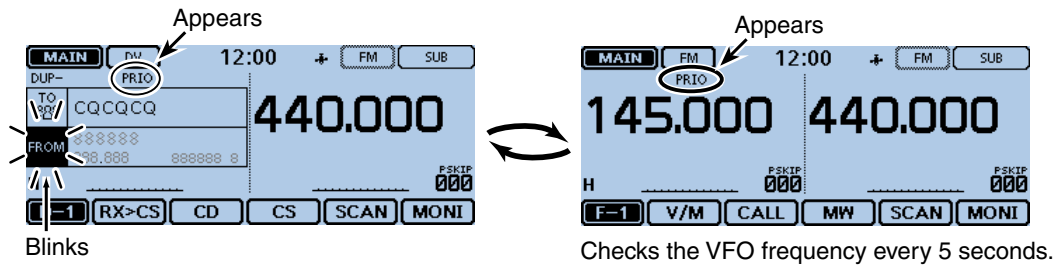

Example: Checks the Memory channel "000" during the DR scan.

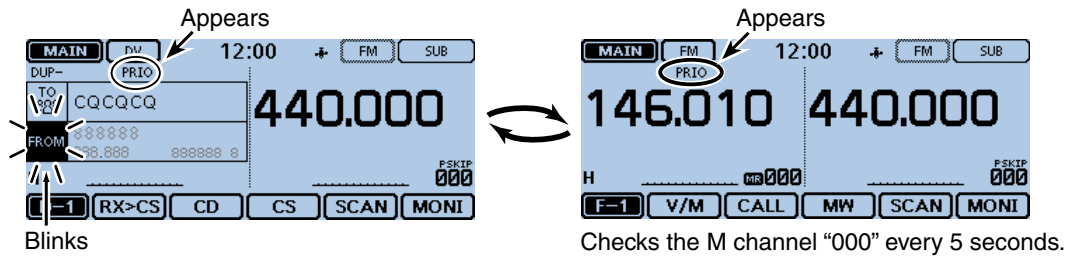

Example: Checks the Bank channel "A00" during the DR scan.

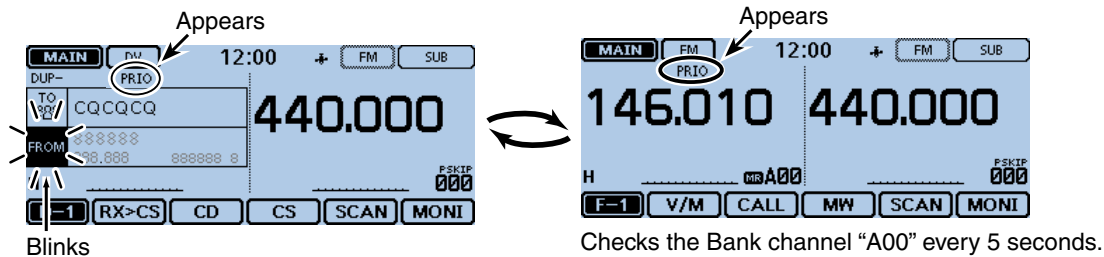

Example: Checks the Call channel "C0 (144)" during the DR scan.

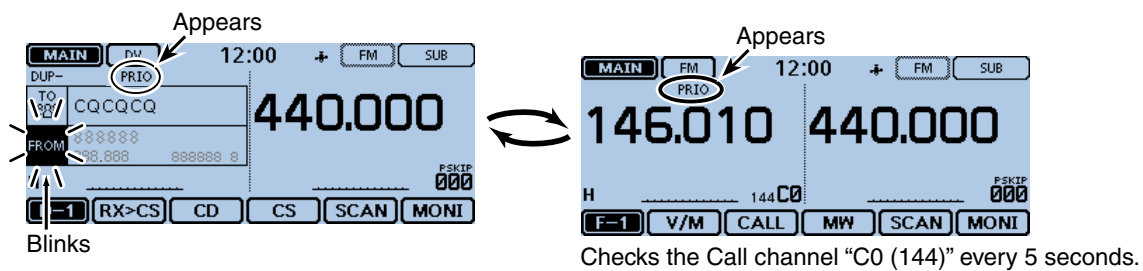

DR scan and a priority channel (Continued)

5. When a signal is received.

• When “ON” is selected.

When a signal is received on the priority channel, the channel is automatically selected. The “PRIO” icon blinks.

* The scan pause timer and resume settings are the same as for a normal scan. (p. 12-14)

• When “Bell” is selected.

When a signal is received on the priority channel, a beep sounds and the “((•))” icon blinks. The DR scan resumes.

Example: For a Memory channel

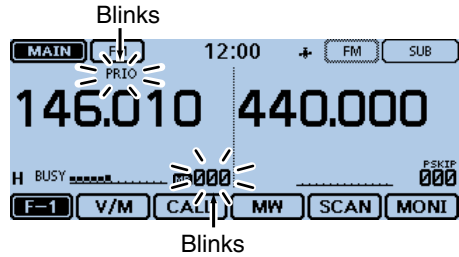

Automatically selects the priority channel.

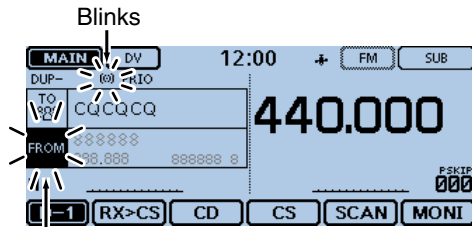

Remains in the DR scan screen.

Unique features of D-STAR.....	6-2
D-STAR Introduction	6-3
About the DR (D-STAR Repeater) function	6-3
Communication Form with the DR function	6-4
Enter your call sign into the transceiver	6-5
Register your call sign at a gateway repeater.....	6-7
Making a Simplex call	6-8
Accessing repeaters	6-9
Using the RX history	6-11
Capturing a call sign	6-12
Making a Local area call	6-13
Making a Gateway Repeater call	6-14
Calling an individual station.....	6-15
Troubleshooting.....	6-16
“FROM” (Access repeater) setting.....	6-18
◇ Using your transceiver’s repeater list.....	6-19
◇ Using the DR scan	6-20
◇ Using the Near Repeater Search function.....	6-21
◇ Using the TX History	6-22
“TO” (Destination) setting.....	6-23
◇ Using the “Local CQ” (Local Area call)	6-24
◇ Using the “Gateway CQ” (Gateway call).....	6-24
◇ Using “Your Call Sign”	6-25
◇ Using the RX History.....	6-26
◇ Using the TX History	6-27
◇ Directly inputting (UR)	6-28
◇ Directly inputting (RPT)	6-29
Reflector operation.....	6-30
◇ What is the reflector?	6-30
◇ Linking to a reflector.....	6-31
◇ Using a reflector	6-32
◇ Unlinking a reflector.....	6-33
◇ Reflector Echo Testing.....	6-33
◇ Requesting repeater information.....	6-34
Updating the repeater list	6-35
Saving settings	6-37

IMPORTANT!

- The repeater list, described in this manual, may differ from your transceiver’s preloaded contents.
- Although Japanese repeaters are used in the setting examples, the Japanese repeater node (port) letters are different from other country’s.

Be sure to add the repeater node letter in the 8th digit of the call sign, according to the frequency band shown below.

1200 MHz : A (B in Japan)

430 MHz : B (A in Japan)

144 MHz : C (no D-STAR repeaters in Japan)

To begin digital mode communication in other than the DR function

To begin the digital mode communication in other than the DR function, you can use the VFO mode, Memory mode and Call channel mode.

This manual description focuses on the DR function operation which can be set up easily. If you want to use in other than the DR function, see the procedures as described to the right.

For a Local area call or Gateway call:

- ① Set the access repeater’s frequency. (p. 11-2)
- ② Set the frequency offset. (p. 11-4)
- ③ Set the Duplex direction. (p. 11-4)
- ④ Set the call signs. (p. 12-37)

For a Simplex call:

- ① Set the operating frequency.
- ② Set the call sign. (p. 12-37)

Unique features of D-STAR

- Easy Cross band operation through the repeater

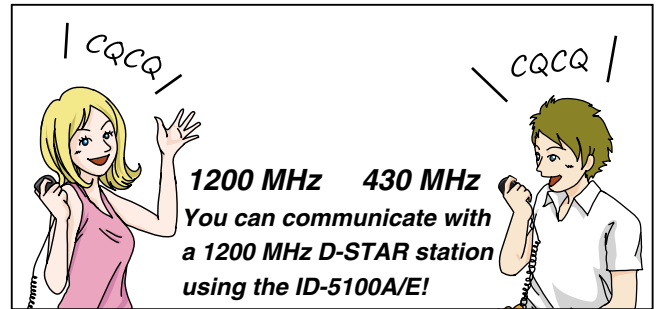

- Easy call sign entry with the Repeater list or TX/RX History

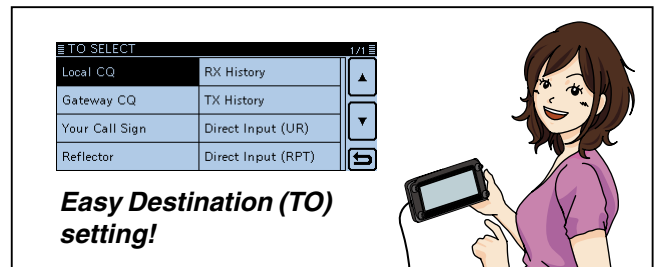

- Call Sign Capture key [RX>CS] makes call sign capture easy.

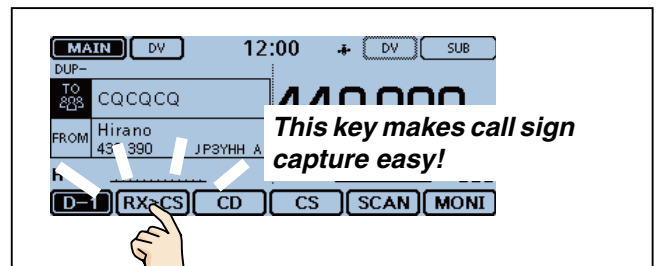

Before starting D-STAR, the following steps are needed.

STEP 1 Entering your call sign (MY) into the transceiver.

STEP 2 Registering your call sign (MY) to a gateway repeater.

IMPORTANT! **STEP 3** Entering your D-STAR equipment into your registration form.

→ You have completed the steps!!

See pages 6-5 to 6-7 for details.

D-STAR Introduction

- In the original D-STAR (Digital Smart Technologies for Amateur Radio) plan, JARL envisioned a system of repeaters grouped together into Zones.
- The D-STAR repeater enables you to call a HAM station near you, or around the world.
- You can transmit and receive digital voice, including low-speed data, at the same time. You can transmit and receive position data from the built-in GPS receiver.

About the DR (D-STAR Repeater) function

You can easily use the D-STAR repeaters with the DR (D-STAR Repeater) function. With this function, you can select the preprogrammed repeater or frequency in "FROM" (the access repeater or simplex), and UR call sign in "TO" (destination), as shown to the right.

NOTE: If the repeater set in "FROM" (Access Repeater) has no Gateway call sign, you cannot make a gateway call.

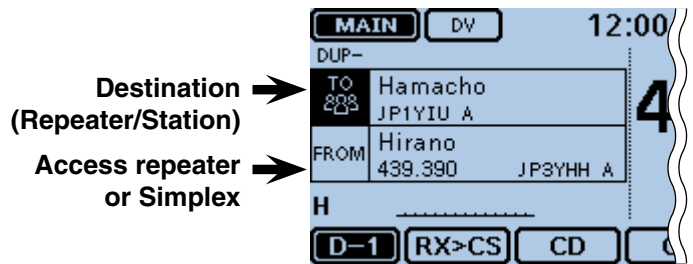

In the DR screen

Communication Form with the DR function

With the DR function, the transceiver has three communication forms, as shown below.

- Local area call: To call through your local area (access) repeater.
- Gateway call: To call through your local area (access) repeater, repeater gateway and the internet to your destination repeater or individual station's last used repeater, using call sign routing.
- Simplex call: To call another station not using a repeater.

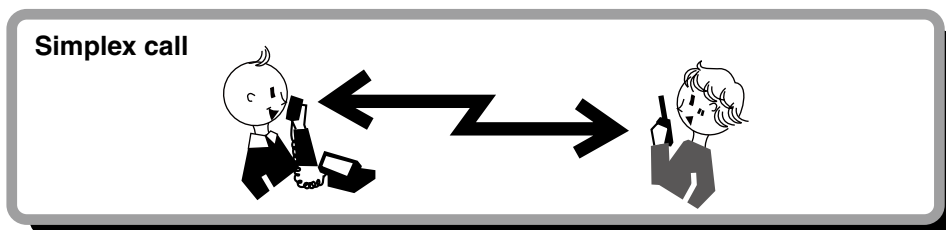
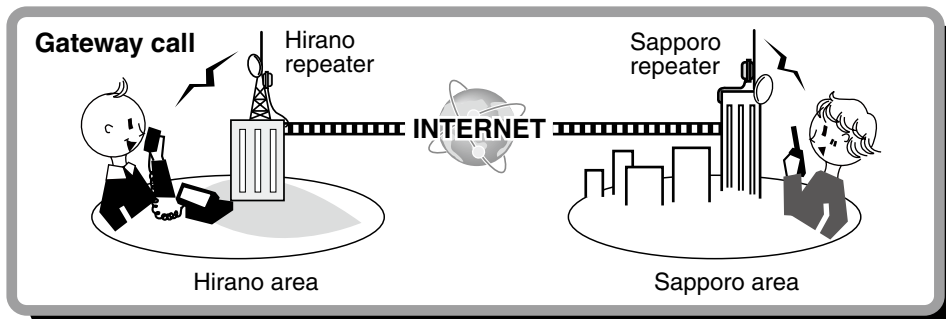
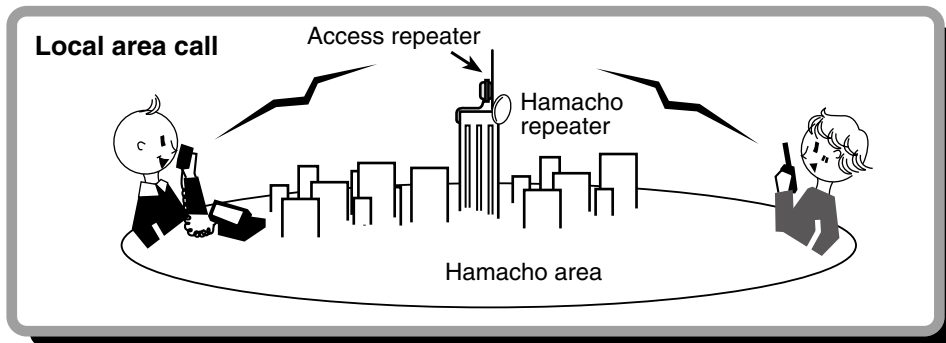

NOTE:

- Using the repeater list is required to use the DR function. (pp. 7-22 to 7-24)
- Before operating in the duplex mode, be sure to check whether the repeater is busy, or not. If the repeater is busy, wait until it is clear, or ask for a “break” using a method acceptable to your local procedures.
- The transceiver has a Time-Out Timer function for DV operation. The timer limits a continuous transmission. Warning beeps will sound approximately 30 seconds before time-out and then again immediately before time-out.

Enter your call sign into the transceiver

IMPORTANT! Before starting D-STAR, registering your call sign (MY) and entering your D-STAR equipment into your registration form are needed.
See page 6-7 for details.

You can enter up to six MY call signs, in [MY1] through [MY6].

Example: Enter “JA3YUA” as your own call sign into the MY call sign memory [MY1].

1. Displays the MY Call Sign edit screen

- ① Touch [MENU].
- ② Touch [My Call Sign].
(My Station > My Call Sign)
 - If the item is not displayed, touch [▲] or [▼] one or more times to select the page.

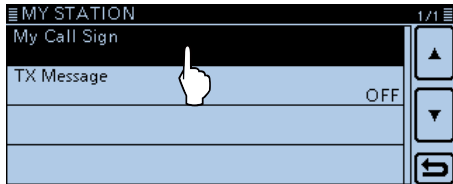
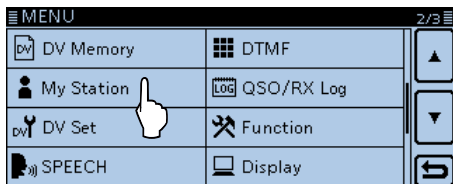

- ③ Touch the MY call sign memory channel “1” ([MY1]) for 1 second.

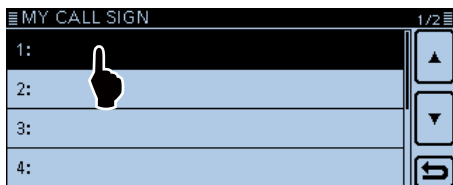

- ④ Touch “Edit.”
 - Opens the “MY CALL SIGN (MY*)” edit screen.
 - The channel number selected in step ③ is displayed on ‘*.’
 - A cursor appears and blinks.

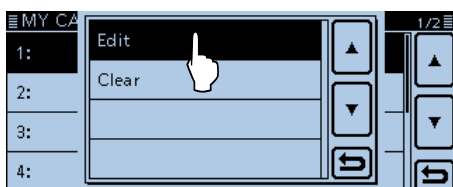

2. Enter the call sign

- ⑤ Touch the desired keypad to select the first digit.
(Example: J).
 - A to Z, 0 to 9, / and (Space) are selectable.
 - Touch “ab↔12” to toggle between the Alphabet entry and Number entry modes.
 - Touch [CLR] to delete the selected character, symbol or number.
 - Touch “SPACE” to enter a space.
 - Touch [QUICK], and then touch “Switch to Tenkey” to switch the keyboard type.



- ⑥ Touch [←] to move the cursor backwards, or touch [→] to move the cursor forwards.
- ⑦ Repeat steps ⑤ and ⑥ to enter your call sign of up to 8 characters, including spaces.
(Example: First J, then A, then 3, then Y, then U, then A)



NOTE: Your call sign must match the call sign you registered. (p. 6-7)

Keys used for entry

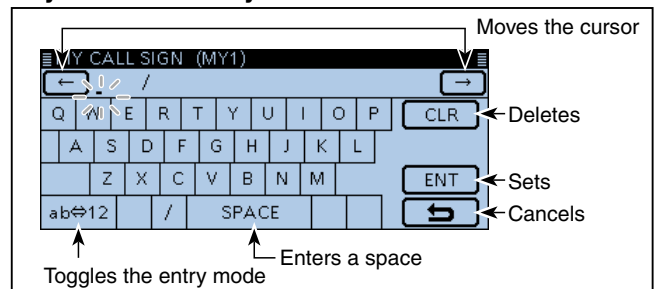

Continued on the next page

Enter your call sign into the transceiver (Continued)

3. Save the call sign

- ⑧ Touch [ENT].
 - Saves the entered call sign and returns to the “MY CALL SIGN” screen.
 - See “Convenient” below if you want to enter a note.

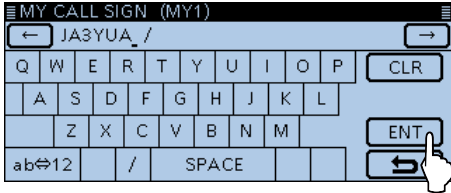

- ⑨ Touch the entered call sign.
 - Sets the call sign to be used as MY call sign.

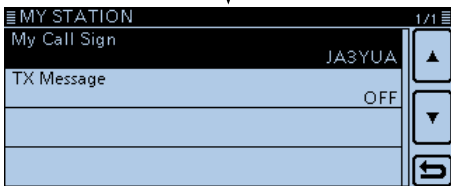

- ⑩ Touch [MENU].
 - Closes the “MY CALL SIGN” screen.

✓ **Convenient!**

If desired, enter a note of up to 4 characters, such as the model of the transceiver, name, area name, and so on, after your call sign.

- ① Touch [→] one or more times until the cursor moves to the right of the “/”.

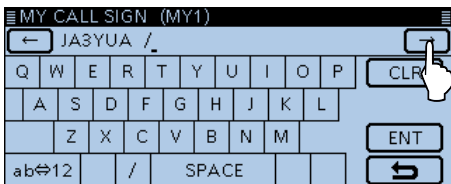

- ② Repeat steps ⑤ and ⑥ on the page 6-5 to enter a 4 character note.
(Example: 5100)

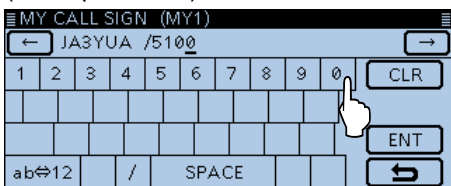

Register your call sign at a gateway repeater

To use the Internet, you must register your call sign with a repeater that has a gateway, usually one near your home location.

About the registration process described:
 This section describes the call sign registration process at a repeater that is connected to the US Trust server.
 There are other systems as well, and they have their own registration process. For information on how to register on one of them, contact the administrator of a repeater that uses the alternate system.

If needed, ask the gateway repeater administrator for call sign registration instructions.

1. Access the call sign registration screen

- ① Access the following URL to find the gateway repeater closest to you.
<http://www.dstarusers.org/repeaters.php>
- ② Click the call sign of the repeater that you want to register to.
- ③ Click the “Gateway Registration URL:” link address.
- ④ The “D-STAR Gateway System” screen appears. Click [Register] to start the New User registration.



2. Register your call sign

- ⑤ Follow the registration instructions found there.
- ⑥ When you receive a notification from the administrator, your call sign registration has been approved.

3. Register your personal information

- ⑦ After your registration is approved, log in your personal account with your registered call sign and password.

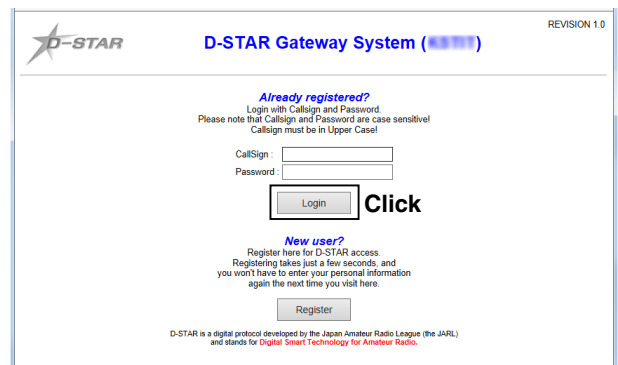

4. Register your D-Star equipment

- ⑧ Register your D-STAR equipment information. Ask the gateway repeater administrator for details.
- ⑨ When your registration is complete, log out of your personal account, and start using the D-STAR network.

NOTE: You must register your D-STAR equipment **BEFORE** you can make calls through the gateway.

Making a Simplex call

You can make a transceiver to transceiver call (through no repeater) in the DR screen.

NOTE: Depending on the transceiver's version, the frequencies may be different. Check for acceptable frequencies for your operating area.

✓ What is a Simplex Call??

A simplex call is a direct call to another station, not using a repeater.

Example: Making a simplex call on 433.450 MHz.

1. "FROM" (Simplex channel) setting

- ① Touch [DR].
 - ② Check whether or not "FROM" is selected.
 - If "FROM" is not selected, touch the "FROM" field.
 - ③ Touch the "FROM" field.
 - Opens the "FROM SELECT" screen.
- "FROM" is selected.

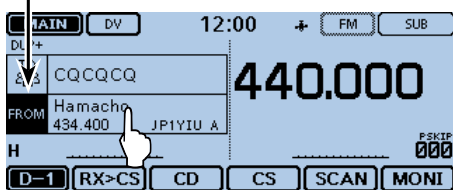

- ④ Touch "Repeater List."
 - Opens the "REPEATER GROUP" screen.

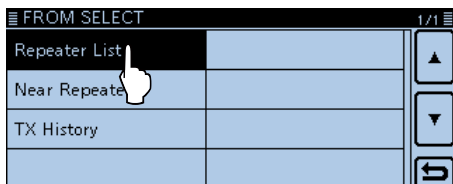

- ⑤ Touch "Simplex."

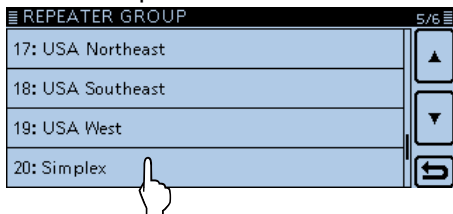

- ⑥ Touch a desired frequency. (Example: 433.450)
 - Returns to the DR screen, and the selected frequency is displayed in "FROM."
 - "CQ CQ CQ" is displayed in "TO."
 - If a station call sign is set in "TO," select "Local CQ" in the "TO SELECT" screen to set "CQ CQ CQ" in "TO."

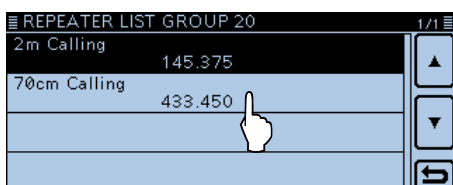

2. Hold down [PTT] to transmit

- The LED1 on the microphone lights red.

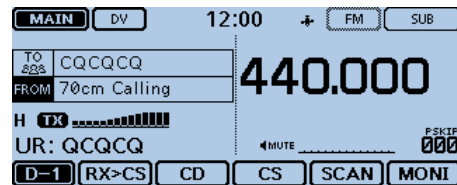

For your reference:

The simplex frequencies can be changed in the MENU screen.
 (DV memory > Repeater List > Repeater group > Simplex)

When you make a simplex call in the VFO mode, the LCD changes, as shown below.

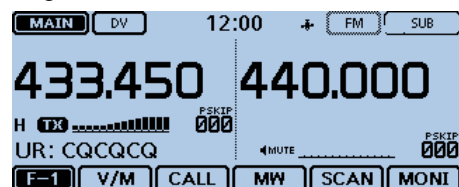

While transmitting in the DV mode

Accessing repeaters

This section describes how to check whether or not you can access your local area repeater (Access repeater), and if your signal is successfully sent to a destination repeater.

▨ If your call sign (MY) has not been set, or your call sign and equipment have not been registered at a D-STAR repeater, see page 6-5 to 6-7.

1. Select your Access repeater (“FROM”)

- ① Touch [DR].
- ② Check whether or not “FROM” is selected.
 - If “FROM” is not selected, touch the “FROM” field.
- ③ Touch the “FROM” field.
 - Opens the “FROM SELECT” screen.

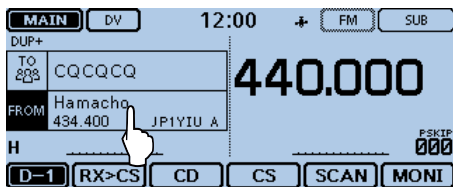

- ④ Touch “Repeater List.”
 - Opens the “REPEATER GROUP” screen.

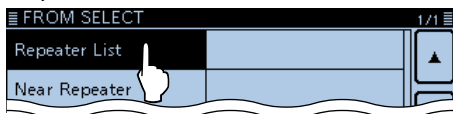

- ⑤ Touch the repeater group where your access repeater is listed. (Example: “11: Japan”)

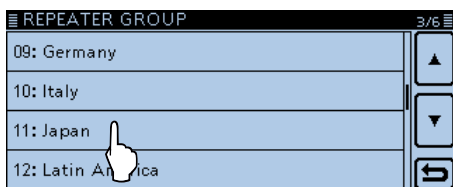

- ⑥ Touch your access repeater. (Example: “Hirano”)

 - Returns to the DR screen, and the selected repeater name is displayed in “FROM.”

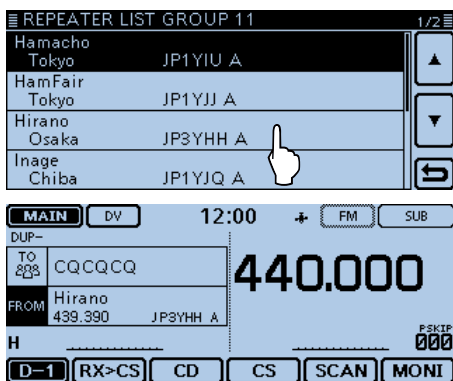

▨ Even if you select just the repeater name, the repeater call sign, its frequency, duplex setting, frequency offset and Gateway call sign are automatically set.

2. Select the Destination repeater (“TO”)

- ⑦ Touch the “TO” field.
 - Check whether “TO” is selected.
- ⑧ Touch the “TO” field again.
 - Opens the “TO SELECT” screen.

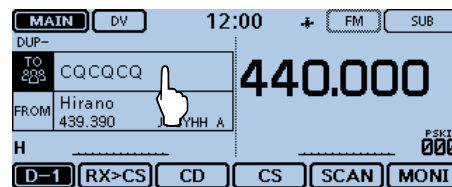

- ⑨ Touch “Gateway CQ.”
 - Opens the “REPEATER GROUP” screen.
- ⑩ Touch the repeater group where your destination repeater is listed. (Example: “11: Japan”)
- ⑪ Touch your destination repeater. (Example: “Hamacho”)

 - Returns to the DR screen, and the selected repeater name is displayed in “TO.”

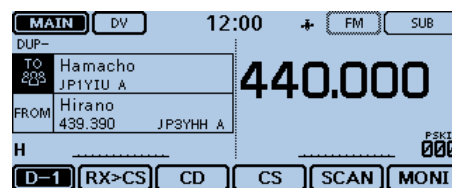
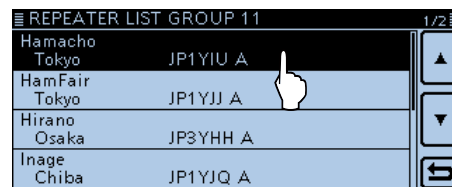

☞ Continued on the next page.

Accessing repeaters (Continued)

3. Check whether you can access the repeater

⑫ Hold down [PTT] for approximately 1 second to access the repeater.

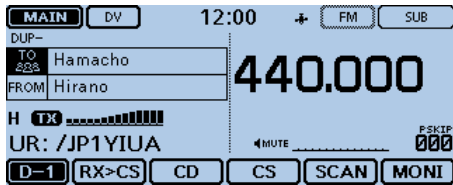

⑬ If you get a reply call, or "UR?" appears on the LCD within 3 seconds, your signal reached your access repeater and your call was successfully sent from your destination repeater.

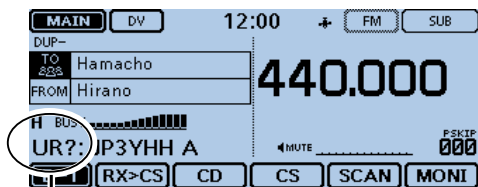

Successfully sent!

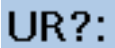

/// **NOTE:** See page 6-16 for status indications after a repeater system reply is received.

Using the RX history

When a DV call is received, the call signs of the caller, the called station and the called station's access repeater are stored in the RX history file. Up to 50 calls can be stored.

This section describes how to view the RX history screen and how to save the call sign to memory.

1. To display a received call sign

- ① Touch the Function group icon one or more times.
 - Selects the D-1 menu.
- ② Touch [CD].
 - Opens the “RX HISTORY” screen.
 - Touch [▲] or [▼] one or more times to select other RX history memories.
 - The first page of the “RX HISTORY” screen displays the latest RX record of the MAIN band. The second page or later displays the record according to the received date and time, regardless of the band it was received on.

RX HISTORY screen (LAST (MAIN))

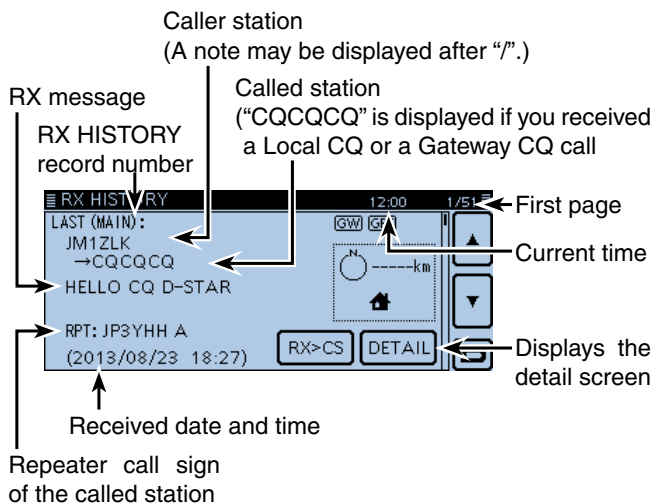

Keys used for entry

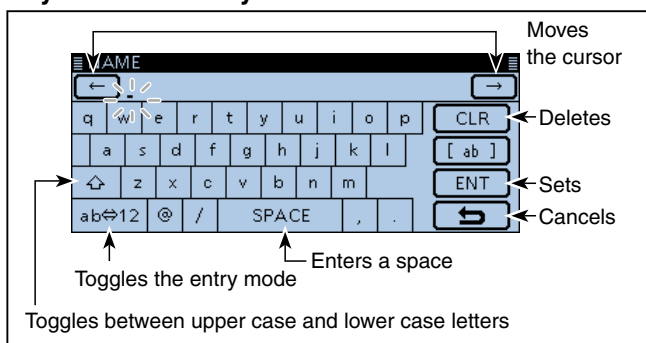

When receiving a call from “JM1ZLK.”

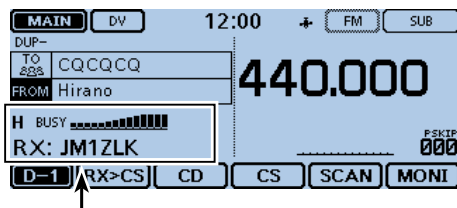

The S-meter appears and the caller's call sign is displayed.

2. Save the destination call sign into your call sign memory from RX History

- ③ Touch [▲] or [▼] one or more times to select the RX HISTORY record with the call sign that you want to save to memory.
- ④ Touch [DETAIL].

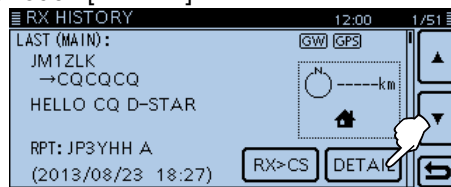

- ⑤ Touch [QUICK].
- ⑥ Touch “Add To Your Memory.”

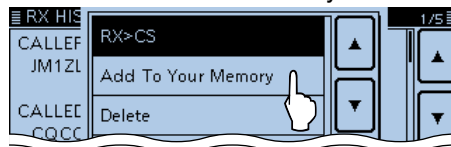

- ⑦ Touch the call sign that you want to save. (Example: “JM1ZLK”)
- /// The display opens the “YOUR CALL SIGN EDIT” screen, and the call sign is automatically set.

- ⑧ Touch “NAME.”
 - Opens the “NAME” screen.
 - Enter a name of up to 16 characters, including spaces. (Example: TOM)



- ⑨ Touch [ENT].
 - Returns to the “YOUR CALL SIGN EDIT” screen.
- ⑩ Touch “<<Add Write>>.”
 - Opens the “Add write?” window.



- ⑪ Touch [YES].
 - Returns to the “RX HISTORY” screen.

Capturing a call sign

After you receive a repeater's signal, the calling station's call sign can be captured by touching the Call Sign Capture key ([RX>CS]) for 1 second. Then you can quickly and easily reply to the call.

✓ What is the Call Sign Capture key??

Touching the Call Sign Capture key for 1 second sets the last received station call sign as a temporary destination, and makes replying quick and easy.

While receiving

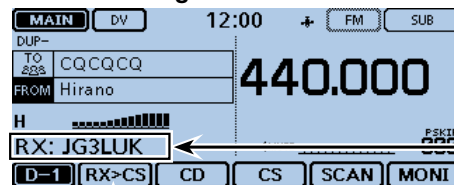

When receiving a call from "JG3LUK."

Call Sign Capture key

1. Set the received call sign to the destination

- Touch the Function group icon one or more times.
 - Selects the D-1 menu.

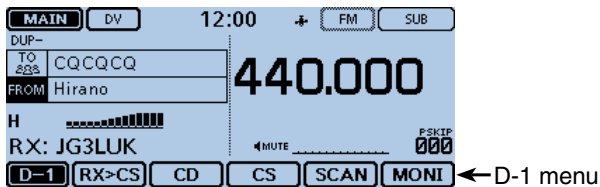

- Touch [RX>CS] for 1 second.
 - Beep sounds when touched.
 - After 1 second, two beeps sound, and the station call sign is announced.

When you touch [RX>CS].

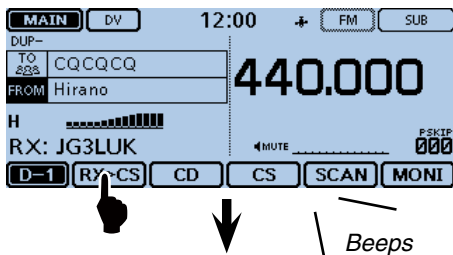

After 1 second

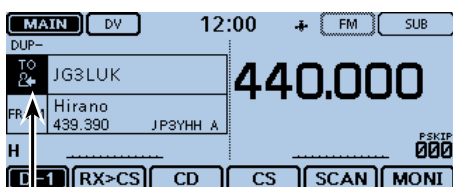

Blinks after selecting a call sign.

Beeps
JG3LUK

2. Hold down [PTT] to transmit

- The LED1 on the microphone lights red.

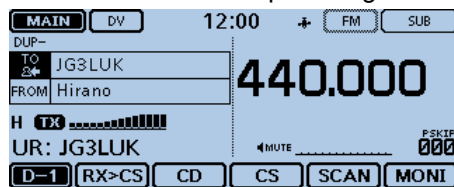

- Touch [RX>CS].

- Returns to the previous call sign setting.

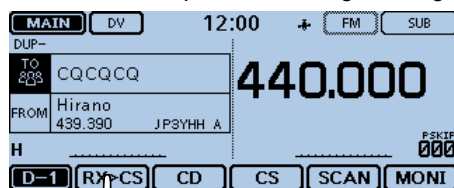

Returns to the previous screen

When a received signal is weak or during DR scanning, the call sign may not be correctly received. In that case, you cannot capture a call sign.

For your reference:

After touching [RX>CS], you can select another call sign in the RX history.

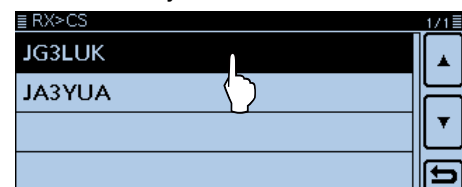

Making a Local area call

A Local area call can be made when “Local CQ” is used to set “CQCQCQ” in “TO” (Destination).

✓ What is a Local Area Call??

To call through your local area (access) repeater.

1. Set “FROM” (Access repeater)

- ① Touch [DR].
- ② Check whether or not “FROM” is selected.
 - If “FROM” is not selected, touch the “FROM” field.
- ③ Touch the “FROM” field.
 - Opens the “FROM SELECT” screen.

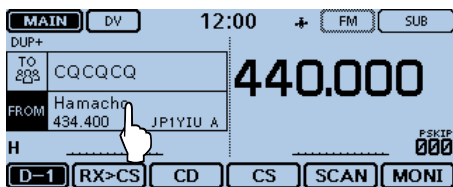

- ④ Touch “Repeater List.”
 - Opens the “REPEATER GROUP” screen.

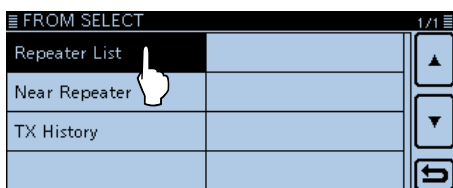

- ⑤ Touch the repeater group where your access repeater is listed. (Example: “11: Japan”)

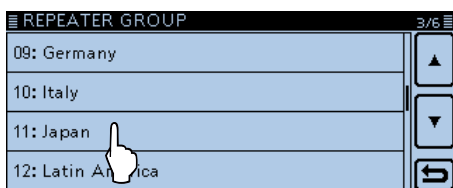

- ⑥ Touch your access repeater. (Example: “Hirano”)

 - Returns to the DR screen, and the selected repeater name is displayed in “FROM.”

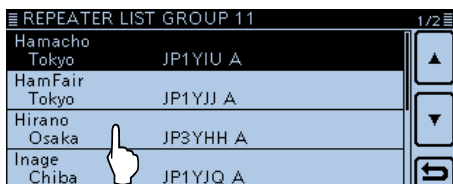

2. Set “TO” (Destination)

- ⑦ Touch the “TO” field.
 - Check whether “TO” is selected.
- ⑧ Touch the “TO” field again.
 - Opens the “TO SELECT” screen.

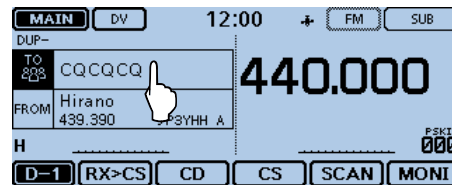

- ⑨ Touch “Local CQ.”
 - Returns to the DR screen, and “CQCQCQ” is displayed in “TO.”

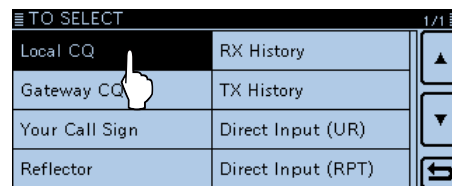

3. Hold down [PTT] to transmit

- The LED1 on the microphone lights red.

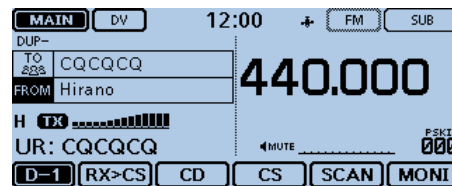

For your reference:
The Local CQ call is used to call anyone, but you can call a specific station by simply saying their call sign.

Making a Gateway Repeater call

A Gateway call can be made when a destination repeater is selected in "TO" (Destination).

- "XGWI" appears when the repeater does not connect to the gateway.

✓ What is a Gateway Repeater Call??

To call through your local area (access) repeater, repeater gateway, and the Internet to your desired destination repeater.

1. Set "FROM" (Access repeater)

- ① Touch [DR].
- ② Check whether or not "FROM" is selected.
 - If "FROM" is not selected, touch the "FROM" field.
- ③ Touch the "FROM" field.
 - Opens the "FROM SELECT" screen.

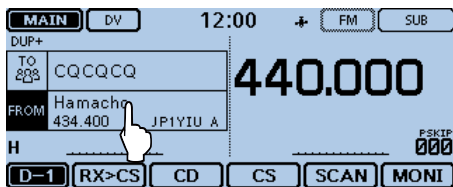

- ④ Touch "Repeater List."
 - Opens the "REPEATER GROUP" screen.

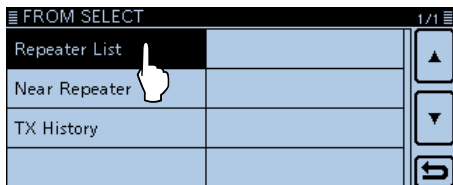

- ⑤ Touch the repeater group where your access repeater is listed. (Example: "11: Japan")

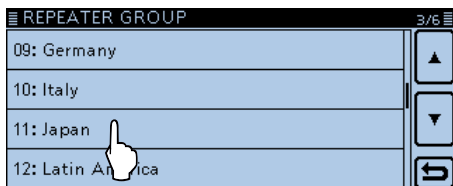

- ⑥ Touch your access repeater. (Example: "Hirano")
 - Returns to the DR screen, and the selected repeater name is displayed in "FROM."

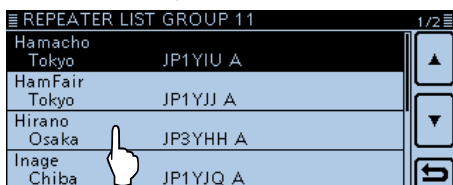

2. Set "TO" (Destination)

- ⑦ Touch the "TO" field.
 - Check whether "TO" is selected.
- ⑧ Touch the "TO" field again.
 - Opens the "TO SELECT" screen.

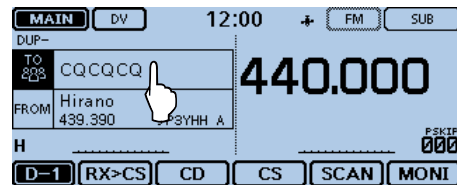

- ⑨ Touch "Gateway CQ."
 - Opens the "REPEATER GROUP" screen.

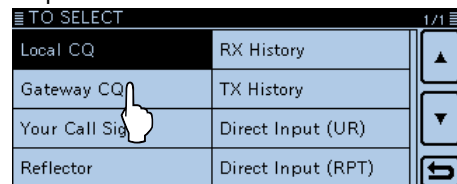

- ⑩ Touch the repeater group where your desired destination repeater is listed. (Example: "11: Japan")

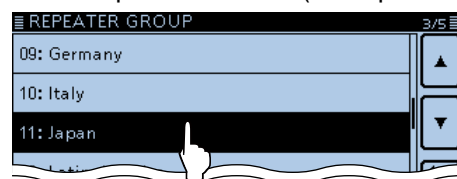

- ⑪ Touch your destination repeater. (Example: "Hamacho")
 - Returns to the DR screen, and the selected repeater name is displayed in "TO."



3. Hold down [PTT] to transmit

- The LED1 on the microphone lights red.

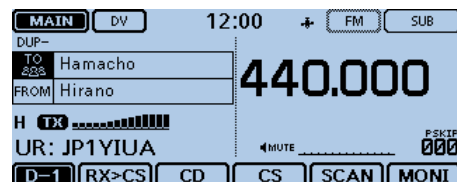

For your reference:

The Gateway CQ call is used to call any repeater, but you can call a specific station by simply saying their call sign.

Calling an individual station

You can make a call to an individual station when the station call sign is selected in "TO" (Destination). When you call an individual station call sign through a gateway, your call is automatically sent to the last repeater that the station accessed. So, even if you don't know where the station is, you can make a call using call sign routing.

1. Set "FROM" (Access repeater)

- ① Touch [DR].
- ② Check whether or not "FROM" is selected.
 - If "FROM" is not selected, touch the "FROM" field.
- ③ Touch the "FROM" field.
 - Opens the "FROM SELECT" screen.

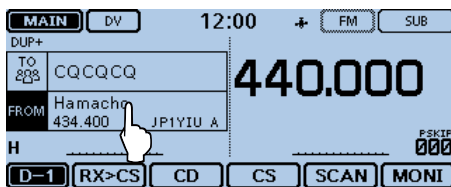

- ④ Touch "Repeater List."
 - Opens the "REPEATER GROUP" screen.

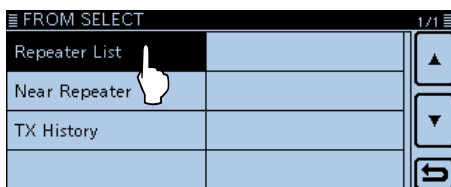

- ⑤ Touch the repeater group where your access repeater is listed. (Example: "11: Japan")

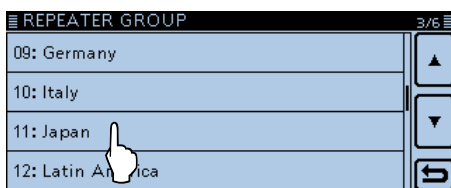

- ⑥ Touch your access repeater. (Example: "Hirano")
 - Returns to the DR screen, and the selected repeater name is displayed in "FROM."

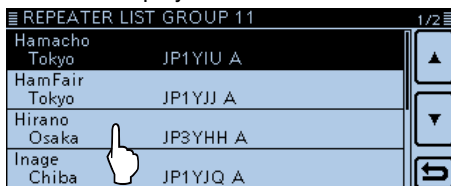

2. Set "TO" (Destination)

- ⑦ Touch the "TO" field.
 - Check whether "TO" is selected.
- ⑧ Touch the "TO" field again.
 - Opens the "TO SELECT" screen.

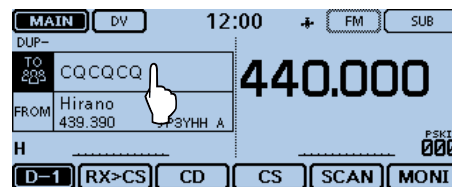

- ⑨ Touch "Your Call Sign."
 - Opens the "YOUR CALL SIGN" screen.

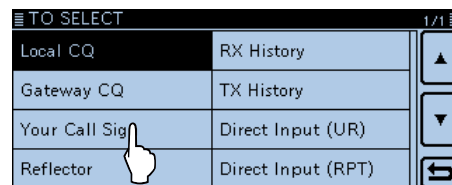

- ⑩ Touch the destination station. (Example: "TOM")
 - Returns to the DR screen, and the selected station name is displayed in "TO."

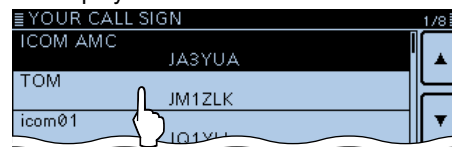

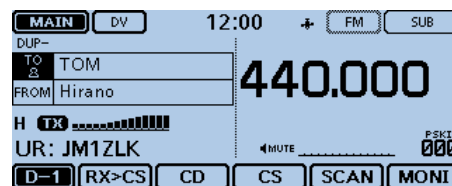

3. Hold down [PTT] to transmit

- The LED1 on the microphone lights red.

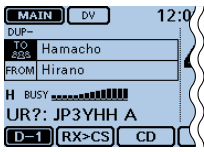
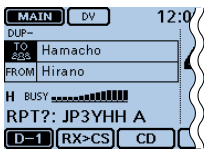

Troubleshooting

To communicate through the repeater, your signal must access to the repeater. When your signal accesses your local repeater, but it is not sent to the destination repeater, the repeater replies with a status message.

PROBLEM	POSSIBLE CAUSE	SOLUTION	REF.
After you transmit, no signal is returned from the repeater. (No S-meter indication)	<ul style="list-style-type: none"> The repeater setting is wrong. Your transmission did not reach the repeater. 	<ul style="list-style-type: none"> Select the correct repeater. Correct the repeater frequency, frequency offset, or duplex setting. Wait until you are closer to the repeater and try it again. Try to access another repeater. 	<p>p. 6-18</p> <p>—</p> <p>—</p> <p>—</p>
After you transmit, the repeater replies 'UR?' and its call sign. 	<ul style="list-style-type: none"> The call was successfully sent, but no station immediately replied. 	<ul style="list-style-type: none"> Wait for a while, and try it again. 	<p>—</p>
After you transmit, the repeater replies 'RX' or 'RPT?' and the access repeater's call sign. 	<ul style="list-style-type: none"> Your call sign has not been correctly set into your transceiver. Your call sign has not been registered on a trust sever. Your call sign is not recognized at the repeater. 	<ul style="list-style-type: none"> Make sure that your call sign is correctly set into your transceiver. Register your call sign on a trust sever through a D-STAR repeater, or confirm the registration of the call sign. 	<p>p. 6-5</p> <p>p. 6-7</p>
After you transmit, the access repeater replies 'RPT?' and its call sign.	<ul style="list-style-type: none"> The call sign of the destination repeater is wrong. 	<ul style="list-style-type: none"> Correctly set the destination repeater call sign. 	<p>—</p>
After you transmit, the repeater replies 'RPT?' and call sign of the destination repeater.	<ul style="list-style-type: none"> The repeater cannot connect to the destination repeater. The repeater is busy. 	<ul style="list-style-type: none"> Check the repeater setting. Wait for a while, and try it again. 	<p>—</p> <p>—</p>
Even holding down [DR], the DR screen does not appear.	<ul style="list-style-type: none"> There is no repeater list in your transceiver. 	<ul style="list-style-type: none"> Reload the repeater list using the SD card. Enter the Repeater list data directly into the transceiver. 	<p>p. 6-35</p> <p>p. 7-22 to p. 7-24</p>
Even holding down [RX>CS], the received call sign does not set to the destination call sign to make a call back.	<ul style="list-style-type: none"> The transceiver did not correctly receive the call sign data. When a received signal is weak, or a signal is received during scanning, the call sign may not be received correctly. In that case, "-----" appears and error beeps sound, and a reply call cannot be made. 	<ul style="list-style-type: none"> Try it again, after the transceiver has correctly received the call sign. 	<p>—</p>
A Local area call can be made, but the Gateway call or destination station call cannot be made.	<ul style="list-style-type: none"> Your call sign (MY) has not been registered on a D-STAR repeater. 	<ul style="list-style-type: none"> Register your call sign (MY) on a D-STAR repeater, or confirm the registration of the call sign. 	<p>p. 6-7</p>
"L" appears on the LCD. 	<ul style="list-style-type: none"> While receiving data through the Internet, some packets may be lost due to a network error. 	<ul style="list-style-type: none"> Wait a while, and try it again. When the transceiver receives corrupted data, and misidentifies it as packet loss, "L" appears, even if it is a Local area call. 	<p>—</p>
"DV" and "FM" icons alternately blink.	<ul style="list-style-type: none"> While in the DV mode, an FM signal is received. 	<ul style="list-style-type: none"> Wait a while, and try it again. 	<p>p. 7-11</p>

6 D-STAR OPERATION <BASIC>

Troubleshooting (Continued)

PROBLEM	POSSIBLE CAUSE	SOLUTION	REF.
The simplex operation cannot be made in the DR screen.	• A repeater frequency is programmed.	• Set a simplex frequency.	p. 6-8
The digital code squelch (CSQL) is impossible.	• The wrong digital code is set.	• Set the correct digital code.	p. 7-17
You don't know how to update the repeater list.	—	• See "Updating the repeater list" to check.	p. 6-35

“FROM” (Access repeater) setting

Your access repeater must be set in “FROM” when you make a call in the DR screen.

You have five ways to set the access repeater.

Setting by [DIAL]

Select the preset repeater by rotating [DIAL] while displaying the DR screen.

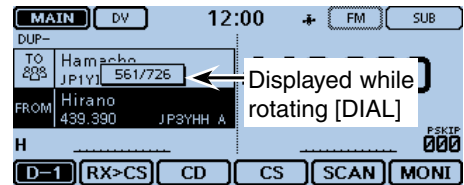

• When you know your access repeater

From the repeater list (p. 6-20)

When your access repeater is in your transceiver’s repeater list, you can select it by selecting the repeater area and name, if entered, or call sign.

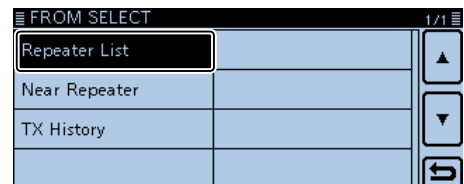

• When you don't know which repeater you can access.

Search for a repeater using the DR scan function (p. 6-21)

The Normal scan searches for, and stops on, input and output repeater frequencies, when a signal is detected.

- The scan will also stop on simplex signals.

The Near Repeater scan searches for up to 20 nearby repeaters by using your location and the repeater’s location, and then lists them. You can find only FM repeaters using the Near Repeater (FM) scan.

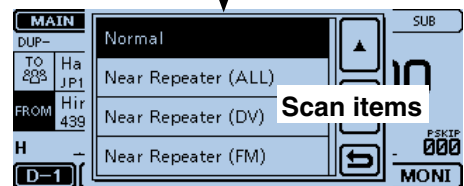
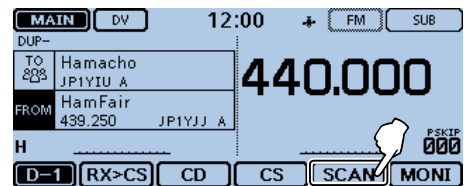

Search for the nearest repeater (p. 6-21)

Searches for the nearest repeater by using your location and the repeater’s location.

The nearest repeaters in your transceiver’s repeater list are displayed as the selectable choices.

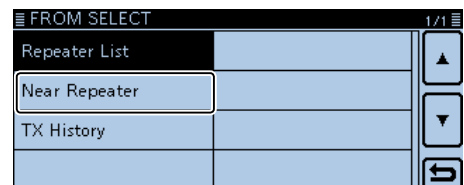

• When the “FROM” data is stored in the TX History.

Setting from the TX History (p. 6-22)

Select a repeater that you have accessed before, from the TX History record.

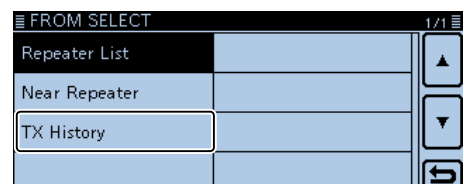

“FROM” (Access repeater) setting (Continued)

◇ Using your transceiver’s repeater list

When your desired access repeater is in your transceiver’s repeater list, you can select it from the list. By only selecting the repeater from the list, the call sign, frequency, duplex and offset frequency settings are automatically set for easy operation.

Example: Select the “Hirano” repeater in Japan from the repeater list.

- ① Touch [DR].
 - Opens the DR screen.
- ② Check whether or not “FROM” is selected.
 - If “FROM” is not selected, touch the “FROM” field.
- ③ Touch the “FROM” field.
 - Opens the “FROM SELECT” screen.

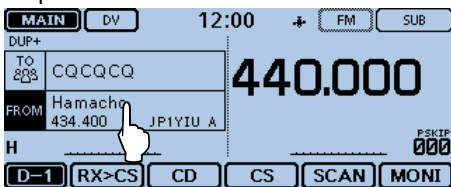

- ④ Touch “Repeater List.”
 - Opens the “REPEATER GROUP” screen.

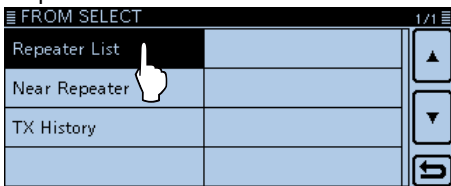

- ⑤ Touch the repeater group where your access repeater is listed. (Example: “11: Japan”)

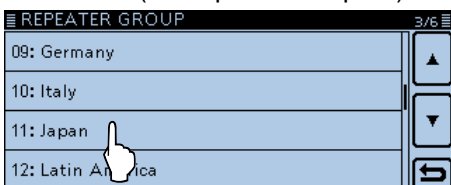

- ⑥ Touch your access repeater to select the repeater name or sub name, if entered, or call sign. (Example: “Hirano”)

• The transceiver returns to the DR screen, and the selected repeater is set in “FROM.”

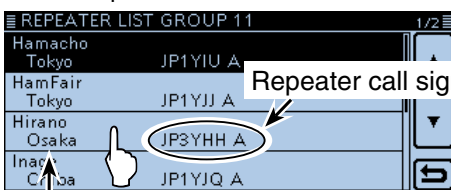

Sub name (repeater area)

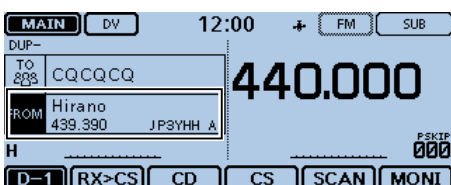

IMPORTANT!

The repeater list, described in this manual, may differ from your transceiver’s preloaded contents.

When you select an FM repeater:

When an FM repeater is in your transceiver’s repeater list, you can select it from the list.

When selecting an FM repeater, the “TO” setting is not necessary and the “---” is displayed in “TO.”

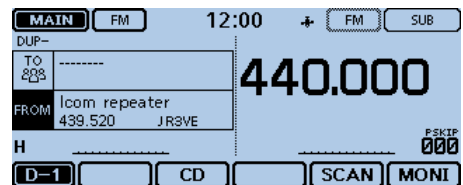

(Sample)

When selecting an FM repeater.

How to switch the repeater group:

► To switch the repeater group in the DR screen, touch [QUICK], and then touch “Group Select.”

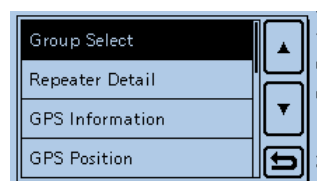

“FROM” (Access repeater) setting (Continued)

◇ Using the DR scan

The DR scan scans frequencies to find a signal on a repeater or a simplex frequency. You can use two kinds of DR scans, Normal scan and Near Repeater scan.

Normal scan

To quickly find a repeater, the Normal scan skips repeaters that are not specified as an access repeater. (The “USE (FROM)” setting is set to “NO” (SKIP is set) on the repeater list.)

Near Repeater scan

The Near Repeater scan searches for up to 20 nearby repeaters by using your location and the repeater’s location, and then lists the repeaters.

NOTE:

Even if your transceiver receives a signal from a repeater, the repeater may not receive your signal, because the repeater’s output power is higher than your transceiver’s.

For your reference:

- Touching [SCAN] for 1 second starts the last used scan.
- The DR scan scans the simplex frequencies in the repeater list, in addition to a D-STAR repeaters.

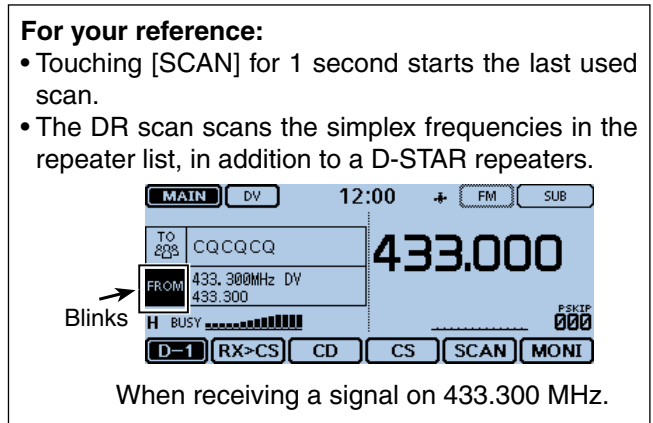

Example: Select the “Hirano” repeater in Japan using the DR scan.

- ① Touch [DR].
 - Opens the DR screen.
- ② Touch the Function group icon one or more times.
 - Selects the D-1 menu.
- ③ Touch [SCAN].
 - Opens the DR scan setting window.

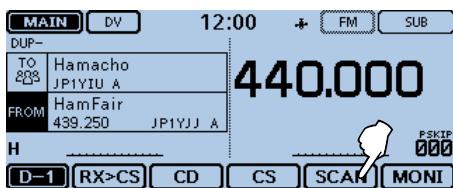

- ④ Touch the desired scan.
 - **Normal:** Searches for repeaters whose “USE (FROM)” setting is set to “YES.”
 - **Near Repeater (ALL):** Searches for up to 20 nearby DV or FM repeaters. (Total 40 repeaters)
 - **Near Repeater (DV):** Searches for up to 20 nearby DV repeaters.
 - **Near Repeater (FM):** Searches for up to 20 nearby FM repeaters.

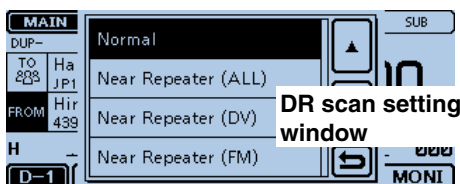

- The selected scan starts.
- The frequency decimal point and “FROM” blink while scanning.
- The scan pauses when a signal is received. The scan resumes the same as other scans. (p. 12-14)

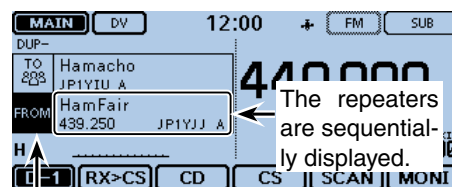

Blinks While DR scanning

- ⑤ When the transceiver receives a signal from a repeater, the scan stops, then touch [SCAN].
 - The DR scan is cancelled.

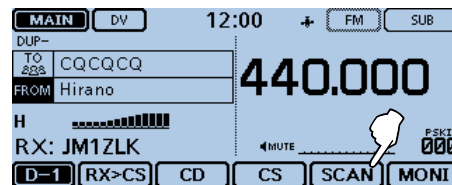

While receiving a signal from a repeater

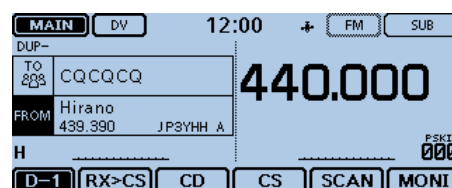

“Hirano” repeater is selected in “FROM.”

“FROM” (Access repeater) setting (Continued)

◇ Using the Near Repeater Search function

The transceiver searches for the nearest repeater by using your location and the repeater’s position. The nearest repeater in your transceiver’s repeater list is displayed as the available choices.

Example: Select the “Hirano” repeater in Japan from the Near Repeater list.

1. Receiving your own position from the GPS receiver

When it is difficult to receive signals indoors, even if you are near a window, try going outdoors for better reception.

① Check whether or not the GPS receiver is receiving your position.

- The GPS icon blinks when searching for satellites.



- The GPS icon stops blinking when the minimum number of satellites needed is found.



- It may take only a few seconds to receive. But depending on the environment, it may take a few minutes. If you have difficulties receiving, we recommend that you try a different location.

2. Selecting the access repeater from the Near Repeater list

② Touch [DR].

- Opens the DR screen.

③ Check whether or not “FROM” is selected.

- If “FROM” is not selected, touch the “FROM” field.

④ Touch the “FROM” field.

- Opens the “FROM SELECT” screen.

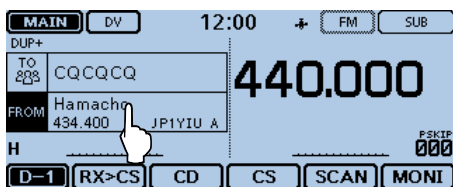

⑤ Touch “Near Repeater.”

- The “NEAR REPEATER” screen appears.

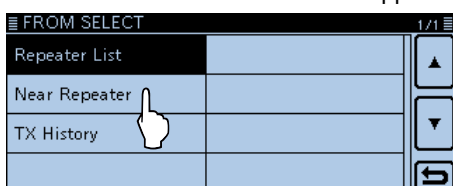

NOTE:

When using the Repeater Search function, be sure to first receive your own position data, or manually enter your position data.

- If no repeater is found in a 160 kilometer range, “GPS is invalid. Search by last valid position” will be displayed.
- If the last received position can be used, “No Repeater Found” will be displayed.

⑥ Touch the desired type of nearby repeater to display.

- **Near Repeater (ALL):** Displays up to 20 nearby DV or FM repeaters. (Total 40 repeaters)
- **Near Repeater (DV):** Displays up to 20 nearby DV repeaters.
- **Near Repeater (FM):** Displays up to 20 nearby FM repeaters.

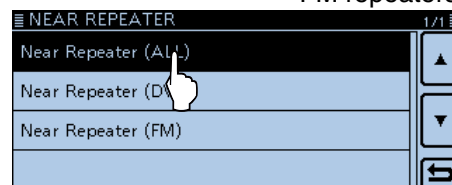

⑦ Touch the repeater to select it as your access repeater, considering the distance from your position to the repeater. (Example: “Hirano”)

- The transceiver returns to the DR screen, and the selected repeater is set in “FROM.”

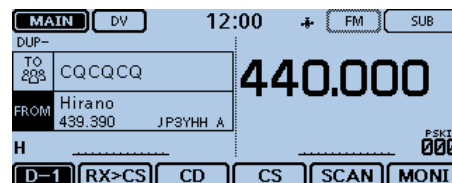
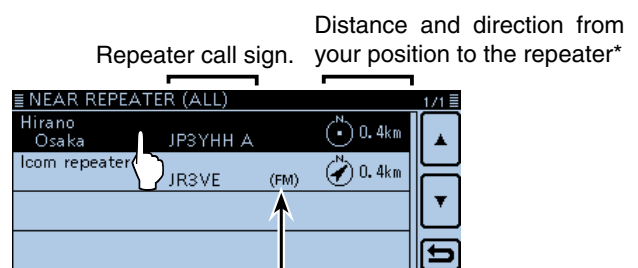

The “Hirano” repeater is selected in “FROM.”

*When the position data accuracy level is set to “Approximate,” the direction data is not displayed if the distance to the repeater is under 5 kilometers. (p. 7-24)

“FROM” (Access repeater) setting (Continued)

◇ Using the TX History

Repeaters you transmitted on before are stored in the TX History. You can select a repeater from the TX History as your access repeater.

The TX History stores up to 10 of the latest “FROM” (Access) repeaters.

Example: Select the “Hirano” repeater in Japan from the TX History.

- ① Touch [DR].
 - Opens the DR screen.
- ② Check whether or not “FROM” is selected.
 - If “FROM” is not selected, touch the “FROM” field.
- ③ Touch the “FROM” field.
 - Opens the “FROM SELECT” screen.

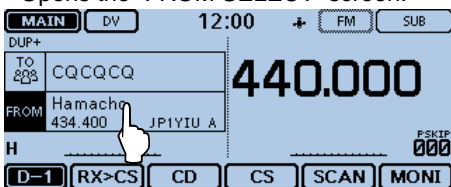

- ④ Touch “TX History.”
 - Opens the “TX HISTORY” screen.

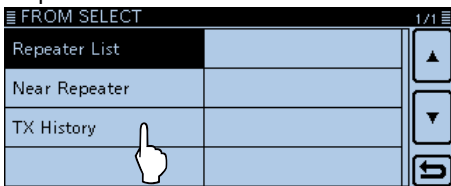

- ⑤ Touch the desired TX history.
 - **TX History (DV):** Displays the TX history of the DV repeaters.
 - **TX History (FM):** Displays the TX history of the FM repeaters.

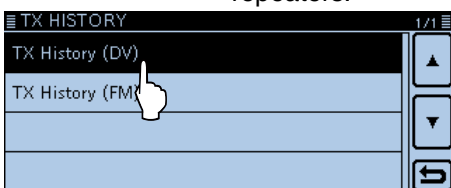

- ⑥ Touch the repeater to use as your access repeater. (Example: “Hirano”)
 - The transceiver returns to the DR screen, and the selected repeater is set in “FROM.”

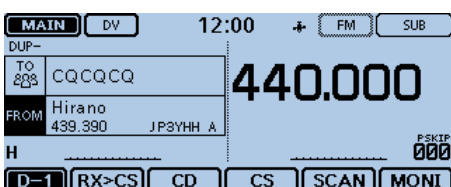
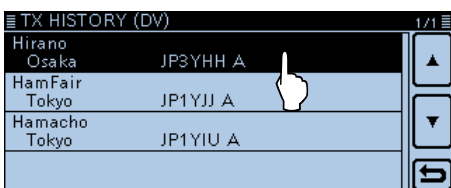

For your reference:
 When you touch [QUICK] in the step ⑥, you can display detailed repeater information on the TX HISTORY screen, or delete it from there.

“TO” (Destination) setting

The destination repeater or station must be set in “TO” when you make a call in the DV mode. You have eight ways to set the destination.

For your reference:

After you receive the individual station or repeater’s signal, the call sign can be captured by holding down the Call Sign Capture key ([RX>CS]), and you can quickly and easily reply to a call.

Setting by rotating [DIAL]

Rotate [DIAL] to select the repeater or Your Call Sign that is displayed on the DR screen. (This operation is disabled when “CQCQCQ” is set.)

To make a Local Area CQ call

“Local CQ” setting (p. 6-13)
Set “CQCQCQ” in “TO” (Destination).

To make a Gateway CQ call

“Gateway CQ” setting (p. 6-14)
Select a repeater from the repeater list, if you want to make a Gateway call.

To select from RX History

Setting from RX History (p. 6-26)
When you receive a call, the repeater or caller station data is stored in RX History. You can select the destination from the record.

To select from TX History

Setting from TX History (p. 6-27)
When you make a call, the destination repeater or called station data is stored in TX History. You can select the destination from the record.

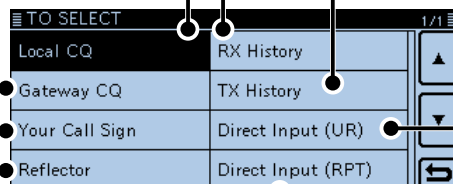

[TO SELECT] screen

To make a call through a reflector

“Reflector” setting (p. 6-31)
Select a reflector you want to call through.

To directly enter the destination station call sign

Direct Input (UR) (p. 6-28)
Directly enter the destination station’s call sign.

To make a call to a specific station

“Your Call Sign” setting (p. 6-25)
Select the station call sign in the Your Call Sign memory.

To directly enter the destination repeater call sign

Direct Input (RPT) (p. 6-29)
Directly enter the destination repeater’s call sign.

How to change the repeater group:

When “Local CQ” or “Gateway CQ” is selected, you can change the repeater group.

➔ While in the DR screen, touch [QUICK], and then touch “Group Select.”

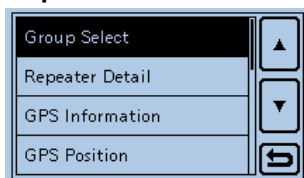

“TO” (Destination) setting (Continued)

◇ Using the “Local CQ” (Local Area call)

When “Local CQ” is selected in the “TO SELECT” screen, “CQCQCQ” is set in “TO.”

Example: Making a Local area call by accessing the “Hirano” repeater.

- ① Touch [DR].
- ② Check whether or not “TO” is selected.
 - If “TO” is not selected, touch the “TO” field.
- ③ Touch the “TO” field.
 - Opens the “TO SELECT” screen.

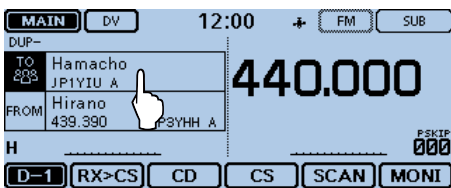

- ④ Touch “Local CQ.”
 - The transceiver returns to the DR screen, and “CQCQCQ” is displayed in “TO.”

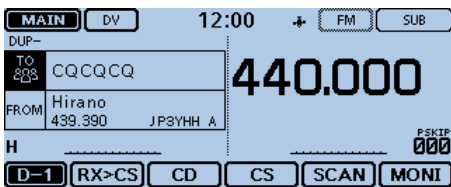
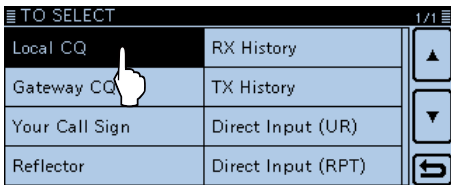

◇ Using the “Gateway CQ” (Gateway call)

When “Gateway CQ” is selected in the “TO SELECT” screen, you can select the repeater to make a gateway call on the repeater list.

Example: Making a gateway CQ call to the “Hamacho” (Japan) repeater from the “Hirano” repeater.

- ① Touch [DR].
- ② Check whether or not “TO” is selected.
 - If “TO” is not selected, touch the “TO” field.
- ③ Touch the “TO” field.
 - Opens the “TO SELECT” screen.

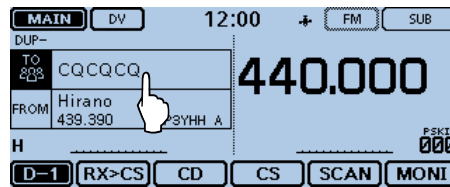

- ④ Touch “Gateway CQ.”
 - Opens the “REPEATER GROUP” screen.

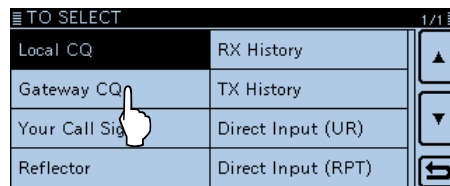

- ⑤ Touch the repeater group where your destination repeater is listed. (Example: “11: Japan”)

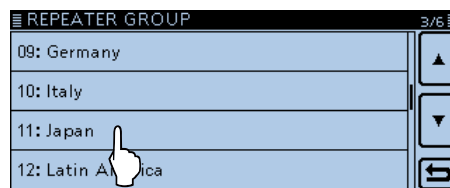

- ⑥ Touch the destination repeater. (Example: “Hamacho”)
 - The transceiver returns to the DR screen, and “Hamacho” is displayed in “TO.”

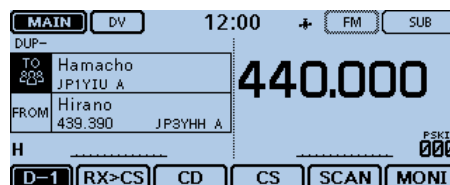
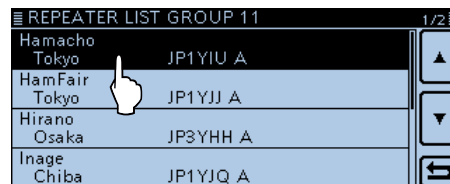

“TO” (Destination) setting (Continued)

◇ Using “Your Call Sign”

The “Your Call Sign” memory stores programmed “UR” (destination) call signs.

When you select an individual station call sign for the “TO” (Destination) setting using “Your Call Sign,” you can make a gateway call.

When you call the destination through a gateway, the signal is automatically sent to the last repeater that the station accessed.

So, even if you don't know where the station is, you can make a call.

NOTE: If the repeater, set in “FROM” (Access Repeater) has no Gateway call sign, you cannot make a gateway call.

Example: Select “TOM” from the “Your Call Sign.”

- ① Touch [DR].
- ② Check whether or not “TO” is selected.
 - If “TO” is not selected, touch the “TO” field.
- ③ Touch the “TO” field.
 - Opens the “TO SELECT” screen.

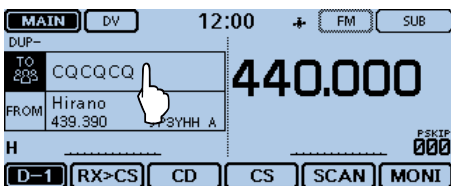

- ④ Touch “Your Call Sign.”
 - Opens the “YOUR CALL SIGN” screen.

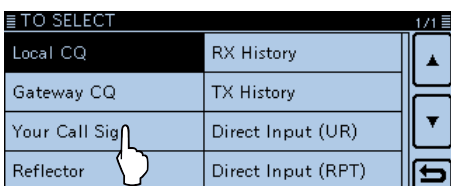

- ⑤ Touch the destination name or call sign. (Example: “TOM”)
 - The transceiver returns to the DR screen, and “TOM” is displayed in “TO.”

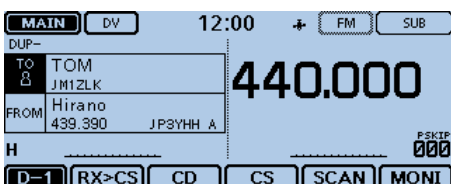
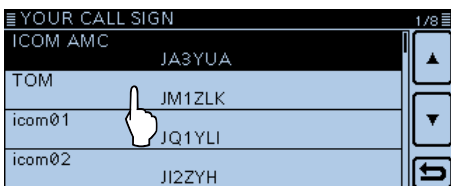

For your reference:
 After selecting a destination, you can select another station preset in your transceiver by rotating [DIAL].

The small screenshot shows the DR screen with the following details:

- Top bar: MAIN DV 12:00
- TO field: TOM JM1ZLK
- FROM field: Hirano 439.390 JP3YHH A
- Buttons: D-1, RX>CS, CD

“TO” (Destination) setting (Continued)

◇ Using the RX History

When a call is received in the DV mode, the call data is stored in the RX History.

Up to 50 Callers, and only the last Called call signs can be stored.

Example: Select “TOM” from RX History.

- ① Touch [DR].
- ② Check whether or not “TO” is selected.
 - If “TO” is not selected, touch the “TO” field.
- ③ Touch the “TO” field.
 - Opens the “TO SELECT” screen.

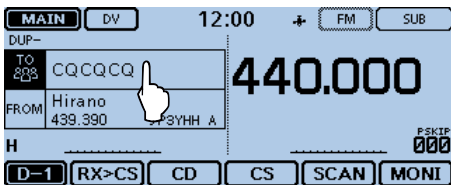

- ④ Touch “RX History.”
 - Opens the “RX HISTORY” screen.

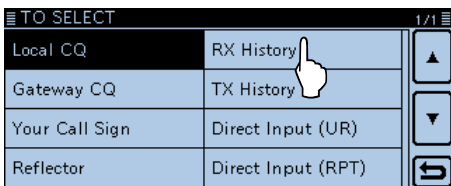

- ⑤ Touch the destination name or call sign.

(Example: “TOM”)

 - If more than 4 entries are stored, touch [▲] or [▼] one or more times to select another page.
 - The transceiver returns to the DR screen, and “TOM” is displayed in “TO.”

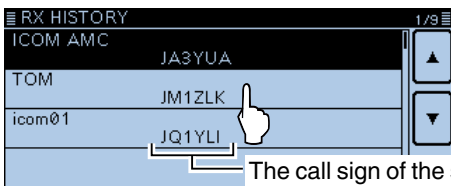

The call sign of the selected station is displayed.

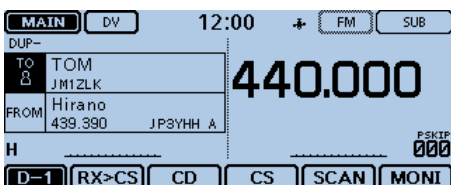

For your reference:
 To add the RX HISTORY data to memory, touch the data for 1 second, and then touch “Add To your Memory.”

“TO” (Destination) setting (Continued)

◇ Using the TX History

The TX History stores the name and/or call sign of up to 20 “TO” (Destination) settings that were used when you made the calls.

NOTE: Until you make a call in the DV mode, you cannot select “TO” (destination) from the TX History.

Example: Select the “Hamacho” repeater in the TX History.

- ① Touch [DR].
- ② Check whether or not “TO” is selected.
 - If “TO” is not selected, touch the “TO” field.
- ③ Touch the “TO” field.
 - Opens the “TO SELECT” screen.

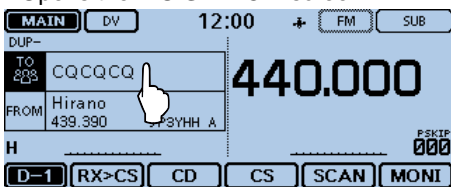

- ④ Touch “TX History.”

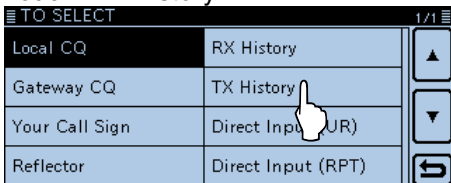

- ⑤ Touch the destination name or call sign. (Example: “Hamacho”)
 - The transceiver returns to the DR screen, and “Hamacho” is displayed in “TO.”

The Sub name is displayed when a repeater is selected.

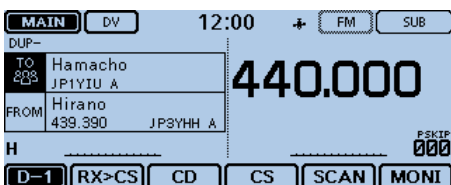
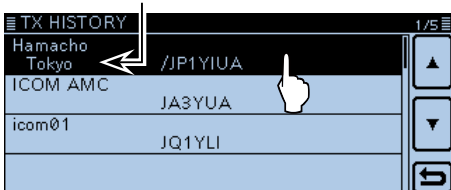

For your reference:

If you touch [QUICK] on the TX HISTORY screen, you can add the selected TX HISTORY data to memory, or delete it from there.

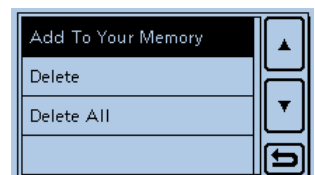

“TO” (Destination) setting (Continued)

◇ Directly inputting (UR)

The destination station call sign can be directly entered.

Example: Directly enter the call sign “JM1ZLK.”

- ① Touch [DR].
- ② Check whether or not “TO” is selected.
 - If “TO” is not selected, touch the “TO” field.
- ③ Touch the “TO” field.
 - Opens the “TO SELECT” screen.

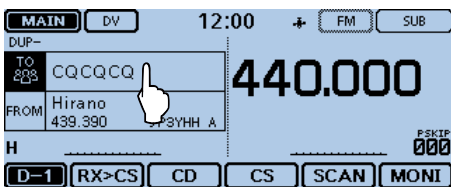

- ④ Touch “Direct Input (UR).”
 - Opens the “DIRECT INPUT (UR)” screen.

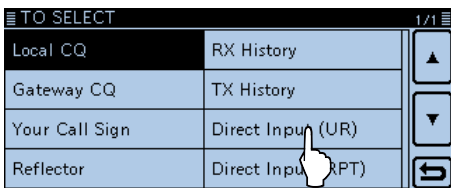

- ⑤ Touch the desired keypad to select the desired character or symbol. (Example: J)
 - A to Z, 0 to 9, / and (Space) are selectable.
 - Touch “ab⇄12” to toggle between the Alphabet entry and Number entry modes.
 - Touch [CLR] to delete the selected character, symbol or number.
 - Touch “SPACE” to enter a space.
 - Touch [QUICK], and then touch “Switch to Tenkey” to switch the keyboard type.
- ⑥ Touch [←] to move the cursor backwards, or touch [→] to move the cursor forwards.

- ⑦ Repeat steps ⑤ and ⑥ to program a call sign of up to 8 characters, including spaces, and then touch [ENT].

(Example: First, J, then M, then 1, then Z, then L, then K.)

- The transceiver returns to the DR screen, and “JM1ZLK” is displayed in “TO.”
- After programming, you can correct the call sign in the “DIRECT INPUT (UR)” screen.
- The programmed call sign remains on the “DIRECT INPUT (UR)” screen, until you enter a new call sign.

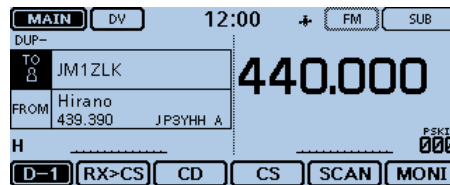
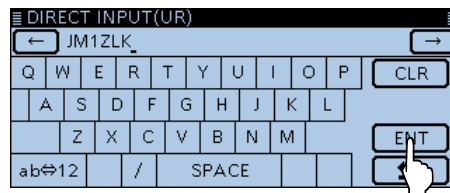

For your reference:

If the programmed call sign is duplicated in “Your Call Sign” memory, the name is displayed. (Only when the name has been programmed.)

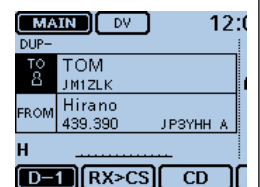

“TO” (Destination) setting (Continued)

◇ Directly inputting (RPT)

The destination repeater call sign can be directly entered.

Example: Directly input the call sign “JP1YIU”

- ① Touch [DR].
- ② Check whether or not “TO” is selected.
 - If “TO” is not selected, touch the “TO” field.
- ③ Touch the “TO” field.
 - Opens the “TO SELECT” screen.

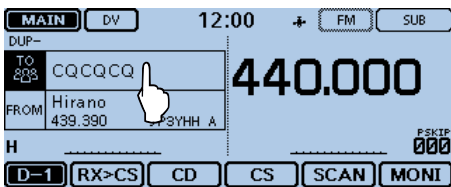

- ④ Touch “Direct Input (RPT).”
 - Opens the “DIRECT INPUT (RPT)” screen.

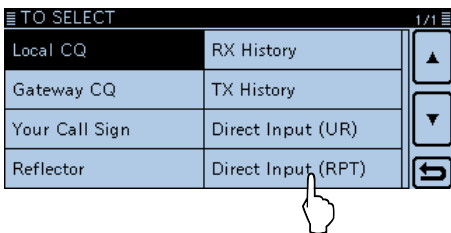

- ⑤ Touch the desired keypad to select the desired character or symbol. (Example: J)
 - A to Z, 0 to 9, / and (Space) are selectable.
 - Touch “ab⇄12” to toggle between the Alphabet entry and Number entry modes.
 - Touch [CLR] to delete the selected character, symbol or number.
 - Touch “SPACE” to enter a space.
 - Touch [QUICK], and then touch “Switch to Tenkey” to switch the keyboard type.
- ⑥ Touch [←] to move the cursor backwards, or touch [→] to move the cursor forwards.

- ⑦ Repeat steps ⑤ and ⑥ to program a call sign of up to 8 characters, including spaces, and then touch [ENT].

(Example: First, J, then P, then 1, then Y, then I, then U, then space, then A.)

- The transceiver returns to the DR screen, and “JP1YIU” is displayed in “TO.”
- After programming, you can correct the call sign in the “DIRECT INPUT (RPT)” screen.
- The programmed call sign remains on the “DIRECT INPUT (RPT)” screen, until inputting a new call sign.

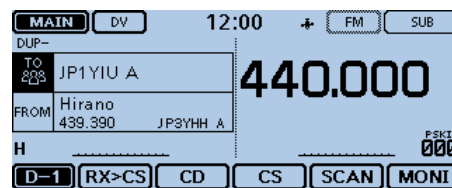
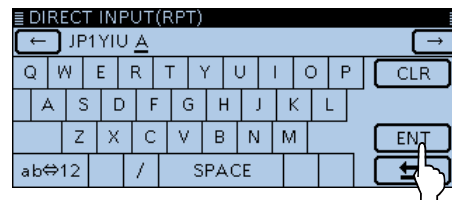

For your reference:

If the programmed call sign is duplicated to the repeater list, the name is displayed. (Only when the name has been programmed.)

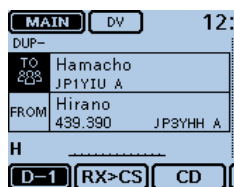

The following setting is also correct.

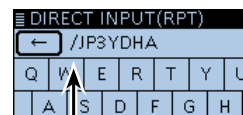

“r” is entered.

In this case, the call sign is of a repeater for a Gateway call.

Reflector operation

◇ What is the reflector?

A reflector is a special server connected to the internet and running a version of dplus software. If the dplus software is installed on your access repeater, it provides various functions including gateway and reflector linking capabilities (It is known as the D-STAR reflector system). The D-STAR reflector system enables a number of D-STAR repeaters around the world to link to a reflector. This means that when you transmit through a D-STAR repeater linked to a reflector, your voice can be heard on other repeaters linked to the reflector, and you can hear other stations that are connected to the reflector.

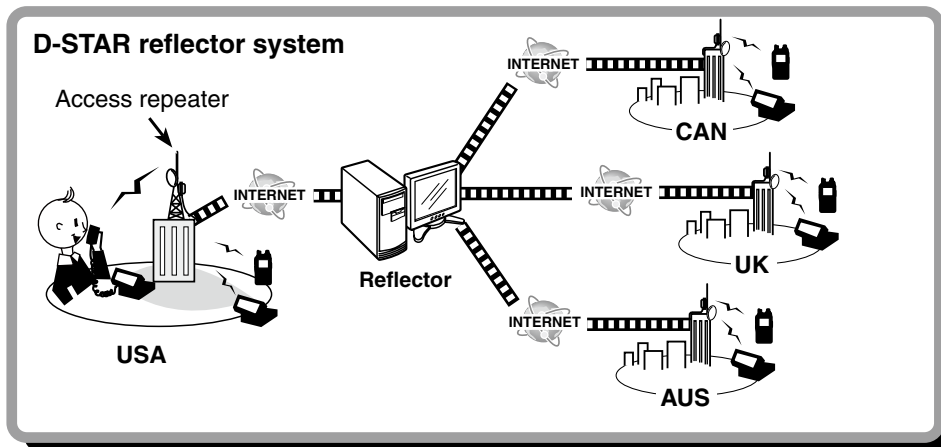

Reflector operation (Continued)

◇ **Linking to a reflector**

If your repeater is not currently linked to a reflector, or you want to change to another reflector, you can do so following the steps below. Before linking to another reflector, be sure to unlink the current reflector.

Direct inputting

Example: Directly enter “REF010BL.”

- ① Touch [DR].
- ② Check whether or not “TO” is selected.
 - If “TO” is not selected, touch the “TO” field.
- ③ Touch the “TO” field.
 - Opens the “TO SELECT” screen.

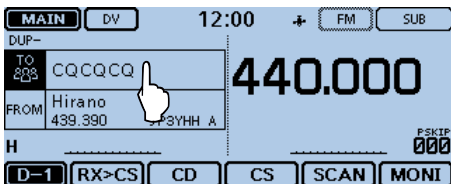

- ④ Touch “Reflector.”
 - Opens the “REFLECTOR” screen.

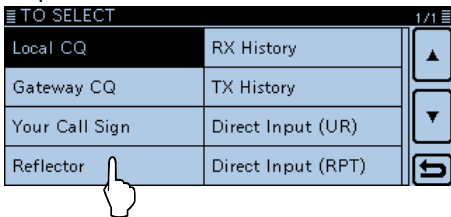

- ⑤ Touch “Link to Reflector.”

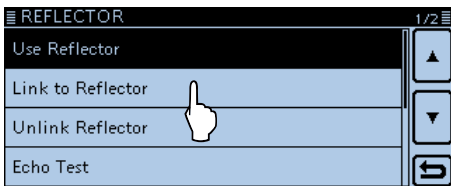

- ⑥ Touch “Direct Input.”

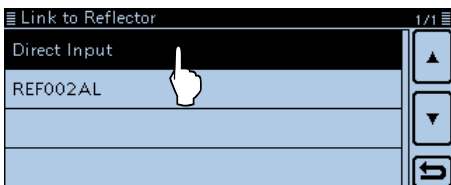

- ⑦ Touch [+] or [-] one or more times to select the reflector number. (Example: 010)
 - Touch [↵] to cancel, and then return to the previous screen.

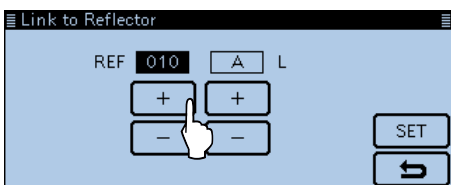

- ⑧ Touch [+] or [-] one or more times on the right-end box to select the module letter. (Example: B)

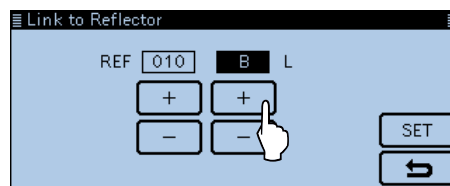

- ⑨ Touch [SET].
 - The transceiver returns to the DR screen.
 - “Link to Reflector” and “REF010BL” are displayed in “TO.”

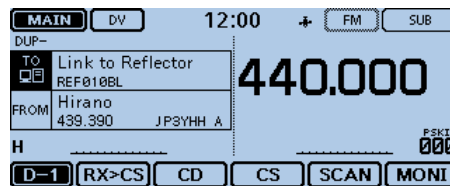

- ⑩ Hold down [PTT] to link to the reflector.
 - The LED1 on the microphone lights red.

Reflector operation

◇ Linking to a reflector (Continued)

Using the TX History

The TX History stores the up to 5 reflectors that your access repeater linked before.

Example: Select the “REF002AL” in the TX History.

- ① Touch [DR].
- ② Check whether or not “TO” is selected.
 - If “TO” is not selected, touch the “TO” field.
- ③ Touch the “TO” field.
 - Opens the “TO SELECT” screen.

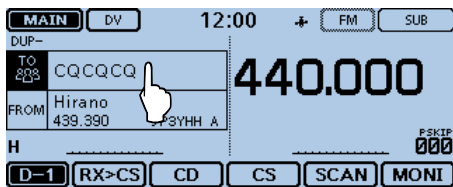

- ④ Touch “Reflector.”
 - Opens the “REFLECTOR” screen.

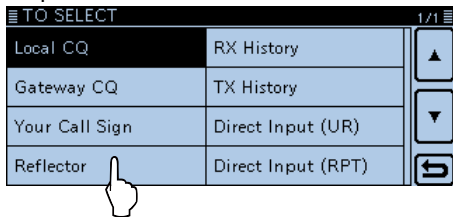

- ⑤ Touch “Link to Reflector.”

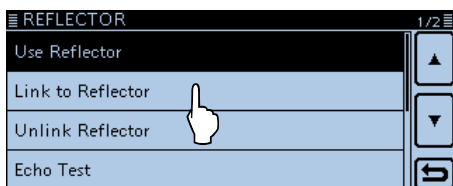

- ⑥ Touch the reflector that you want to link to. (Example: “REF002AL”)
 - The transceiver returns to the DR screen.
 - “Link to Reflector” and “REF002AL” are displayed in “TO.”

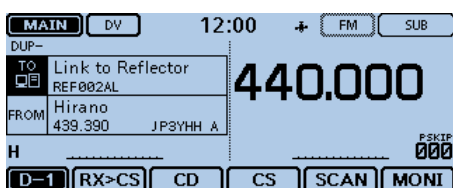
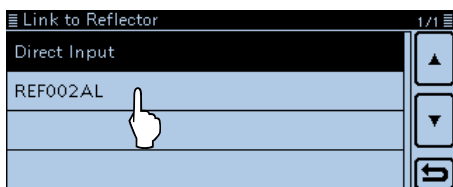

- ⑦ Hold down [PTT] to link to the reflector.
 - The LED1 on the microphone lights red.

Using a reflector

Before using a reflector, be sure to your repeater links to a reflector.

- ① Touch [DR].
- ② Check whether or not “TO” is selected.
 - If “TO” is not selected, touch the “TO” field.
- ③ Touch the “TO” field.
 - Opens the “TO SELECT” screen.

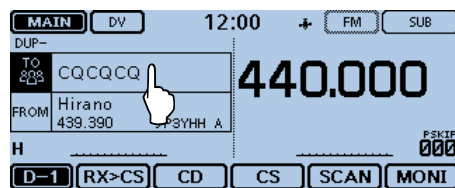

- ④ Touch “Reflector.”
 - Opens the “REFLECTOR” screen.

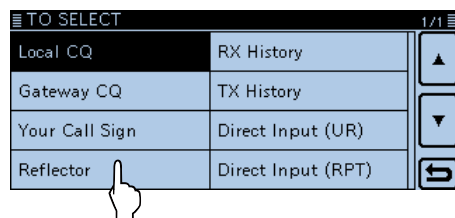

- ⑤ Touch “Use Reflector.”
 - The transceiver returns to the DR screen.
 - “Use Reflector” and “CQCQCQ” are displayed in “TO.”

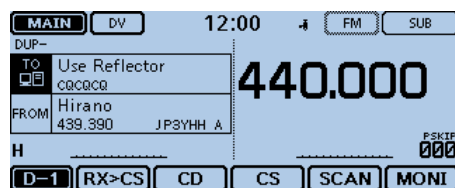
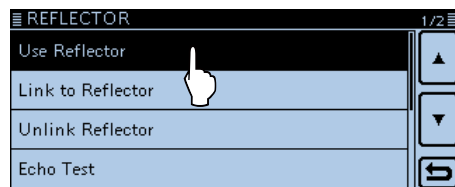

- ⑥ Hold down [PTT] to transmit.
 - The LED1 on the microphone lights red.

Reflector operation (Continued)

◇ Unlinking a reflector

Before linking to another reflector, be sure to unlink the current reflector.

- ① Touch [DR].
- ② Check whether or not “TO” is selected.
 - If “TO” is not selected, touch the “TO” field.
- ③ Touch the “TO” field.
 - Opens the “TO SELECT” screen.

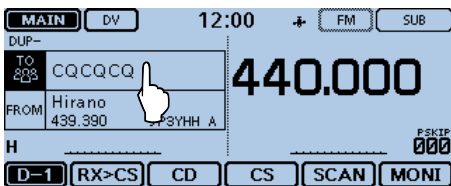

- ④ Touch “Reflector.”
 - Opens the “REFLECTOR” screen.

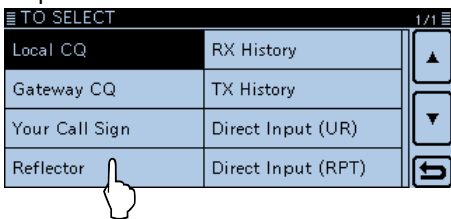

- ⑤ Touch “Unlink Reflector.”
 - The transceiver returns to the DR screen.
 - “Unlink Reflector” and “U” are displayed in “TO.”

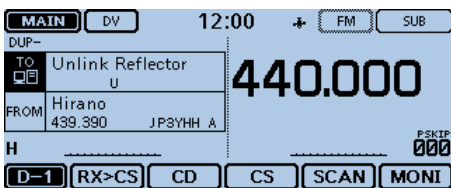
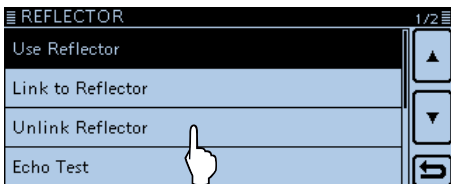

- ⑥ Hold down [PTT] to unlink the reflector.
 - The LED1 on the microphone lights red.

◇ Reflector Echo Testing

This function is a useful check of how well your signal is getting into the repeater, and you can use it to verify that your repeater is operating normally.

- ① Touch [DR].
- ② Check whether or not “TO” is selected.
 - If “TO” is not selected, touch the “TO” field.
- ③ Touch the “TO” field.
 - Opens the “TO SELECT” screen.

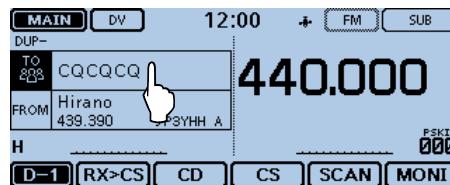

- ④ Touch “Reflector.”
 - Opens the “REFLECTOR” screen.

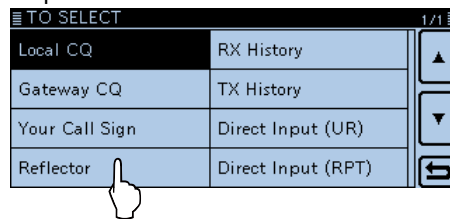

- ⑤ Touch “Echo Test.”
 - The transceiver returns to the DR screen.
 - “Echo Test” and “E” are displayed in “TO.”

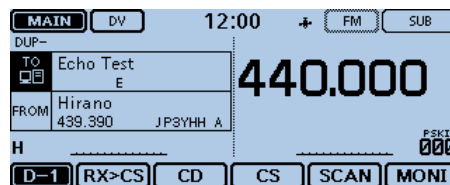
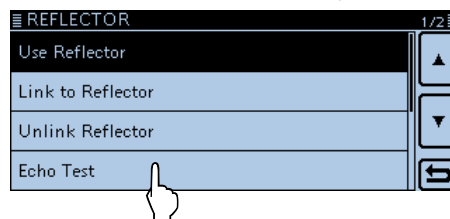

- ⑥ Hold down [PTT] and speak into the microphone.
 - The LED1 on the microphone lights red.
- ⑦ Release [PTT] to hear your message.

Reflector operation (Continued)

◆ Requesting repeater information

When you send the repeater information command, an ID message is sent back.

- ① Touch [DR].
- ② Check whether or not “TO” is selected.
 - If “TO” is not selected, touch the “TO” field.
- ③ Touch the “TO” field.
 - Opens the “TO SELECT” screen.

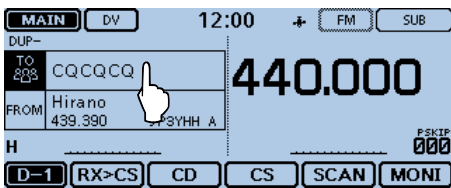

- ④ Touch “Reflector.”
 - Opens the “REFLECTOR” screen.

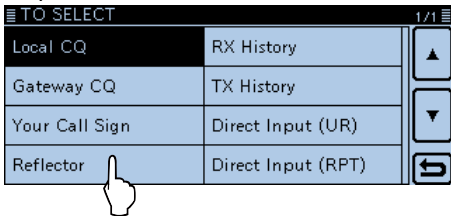

- ⑤ Touch [▼] to select the next page.
- ⑥ Touch “Repeater Information.”
 - The transceiver returns to the DR screen.
 - “Repeater Information” and “I” are displayed in “TO.”

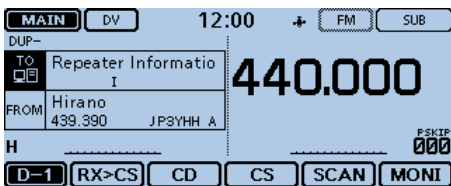
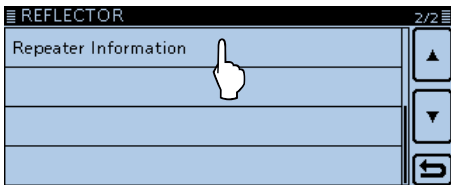

- ⑦ Hold down [PTT] to send the repeater information command.
 - The LED1 on the microphone lights red.
- ⑧ Release [PTT] to hear the repeater ID message.

Updating the repeater list

For easy operation, the repeater list is preloaded into your transceiver.

This section describes how to manually update the repeater list using an SD card.

You can download the latest repeater list from the Icom website.

1. Downloading the latest repeater list

1 Access the following URL to download the latest data.

<http://www.icom.co.jp/world/support/download/firm/index.html>

- The latest repeater list (CSV; Comma Separated Values file) and settings file (ICF file) are contained in the downloaded ZIP file.

File Name: 5100_USA_140401.zip (Example)

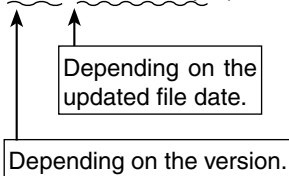

ID-5100A/E's latest repeater list and setting file are uploaded to "Cloning software(Rev. ** *) and manuals" on the Icom website screen.

- The displayed contents may differ.

Model name	Version	last update
ID-5100A	Cloning software(Rev. ** *) and manuals	20**/**/**
ID-5100E	Cloning software(Rev. ** *) and manuals	20**/**/**

This instruction manual description uses the file name "5100_USA_140401.zip," for example.

2 Unzip the ZIP file that you downloaded from the Icom website.

The "5100_USA_140401" (Example) folder will be created.

2. Inserting the SD card into a PC

3 Insert the SD card into the SD card drive on your PC.

- Icom recommends that you format all SD cards to be used with the transceiver, even preformatted SD cards for PCs or other uses. (p. 9-4)

See page 9-4 for details on inserting and removing the SD card.

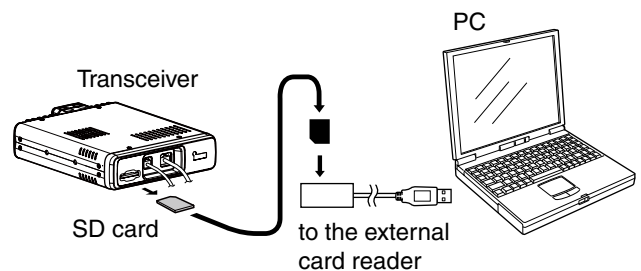

3. Copying the latest repeater list to the SD card

4 Double-click the "5100_USA_140401" (Example) folder created in the same place where the downloaded file is saved.

5 Copy the CSV file (Example: "5100_USA_Rpt_140401.csv") in the folder to [RptList] of the SD card. [ID-5100] > [CSV] > [RptList]

The copied CSV file is placed here.

Continued on the next page

Updating the repeater list (Continued)

4. Inserting the SD card

- 6 Remove the SD card from your PC, and insert it into the transceiver's slot.

See page 9-4 for details on inserting the SD card into the transceiver.

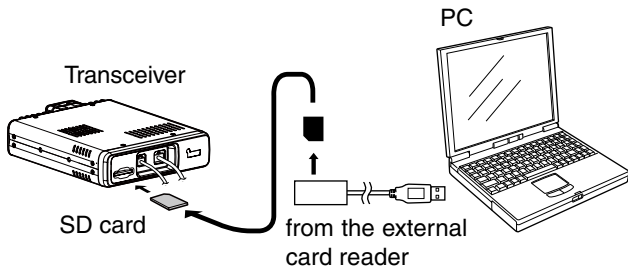

/// Icom recommends that you save the current data before loading other data into the transceiver.

5. Updating the repeater list

- 7 Touch [MENU].
- 8 Touch [Repeater list].
(SD Card > Import/Export > Import > **Repeater list**)
 - If the item is not displayed, touch [▲] or [▼] one or more times to select another page.

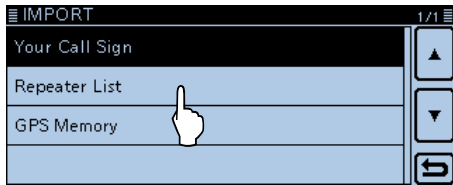

- 9 Touch the CSV file to be loaded.
(Example: "5100_USA_Rpt_140401.csv")
 - The "Keep 'SKIP' settings in Repeater List?" window appears.

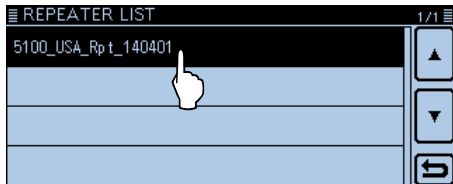

- 10 Touch [YES] or [NO].
 - When you touch [YES], the skip settings of the repeater list are retained.
 - When you touch [CANCEL], returns to the "REPEATER LIST" screen.



- 11 When the "Import file?" appears, Touch [YES].
 - Starts to import.
 - While importing, "IMPORTING" and a progress bar are displayed.

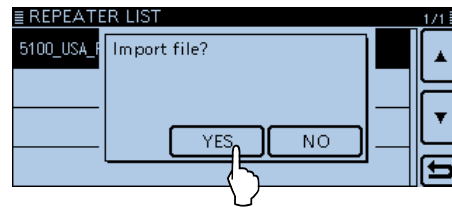

- 12 After importing ends, "COMPLETED!" appears.
To complete the importing, reboot the transceiver.

For your reference:
If you copy the ICF file to [Setting] of the SD card, the repeater list can be updated with the same procedures. In this case, touch "Load Setting."
(SD Card > **Load Setting**)
In the LOAD FILE screen, touch "Repeater List Only."

The screenshot shows the 'LOAD FILE' menu with three options: 'ALL', 'Except My Station', and 'Repeater List Only'. A hand icon is pointing to the 'Repeater List Only' option.

Saving settings

When “FROM” (Access repeater) and “TO” (Destination) settings are saved, the settings can be selected by rotating [DIAL].

1. Saving settings into memory

- ① In the DR screen, select the settings to be saved into memory.

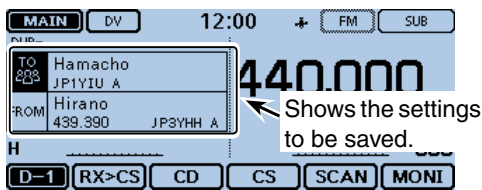

- ② Touch the Function group icon one or more times.
• Selects the D-3 menu.
- ③ Touch [MW] for 1 second.
• The memory contents are briefly displayed, and then the settings are saved into a blank channel.
• “FROM” and “TO” names are automatically programmed as the Memory name.
Up to 16 alphanumeric characters can be programmed for the memory name.

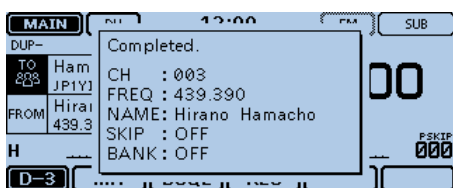
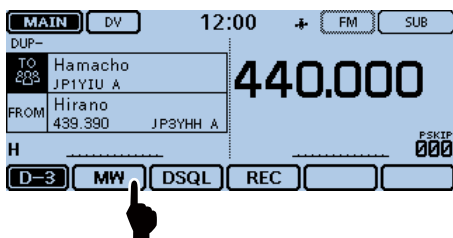

The window automatically closes and the DR screen is displayed again.

2. View the saved contents

- ④ Touch [DR].
• Closes the DR screen.
- ⑤ Touch the Memory channel number.
• Opens the Mode setting window.

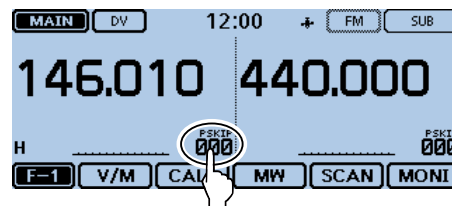

- ⑥ Touch [MR].
• Selects the Memory mode.

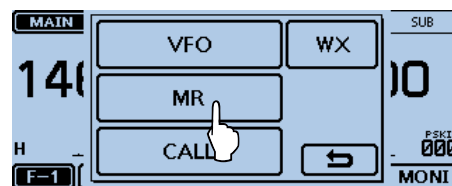

- ⑦ Rotate [DIAL] to select the stored channel.
• Displays the stored channel. (Example: “003”)

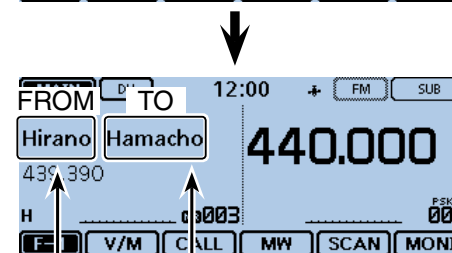
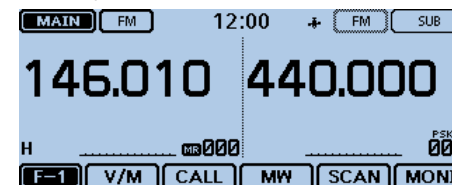

“FROM” and “TO” names are automatically programmed as the Memory name.

Message operation	7-2
◇ Entering a TX message	7-2
◇ Transmitting a message	7-4
◇ TX message deleting.....	7-5
Viewing the received call signs	7-6
◇ View in the RX History screen.....	7-6
BK mode communication	7-8
EMR communication	7-9
◇ Adjusting the EMR AF level.....	7-9
Display type setting	7-10
Automatic DV detection	7-11
Automatic Reply function	7-12
◇ Recording an Auto Reply voice announcement	7-13
◇ Auto Position Reply function.....	7-14
Low-speed data communication	7-15
◇ Connection	7-15
◇ Low-speed data communication application setting.....	7-15
◇ Low-speed data communication.....	7-15
Digital squelch functions	7-16
◇ The digital call sign squelch setting.....	7-16
◇ Digital call sign squelch function with a Pocket beep	7-16
◇ The digital code squelch setting.....	7-17
◇ Digital code squelch function with a Pocket beep	7-17
Viewing the call signs	7-18
Two band monitoring in the DV mode	7-19
Repeater list	7-20
◇ Repeater list contents.....	7-20
Entering new information into the Repeater List	7-21
◇ Required items for the communication cases	7-21
◇ Entering new information into the repeater list.....	7-22
Editing a repeater list	7-25
Deleting a repeater list	7-26
Rearranging the display order of the repeater	7-27
Adding the Repeater information using the RX History	7-28
Skip setting for the DR scan	7-29
◇ Individual skip setting	7-29
Repeater group name programming	7-30
Repeater detail screen	7-31
Entering Your (destination) call sign	7-32
Deleting Your (destination) call sign	7-34
Rearranging the display order of Your (destination) call signs	7-35
Your setting is correct?	7-36
About the repeater list default values	7-37
◇ Opening the default repeater list	7-37

IMPORTANT!

- The repeater list, described in this manual, may differ from your transceiver's preloaded contents.
- Although Japanese repeaters are used in the setting examples, the Japanese repeater node (port) letters are different from other country's.

Be sure to add the repeater node letter in the 8th digit of the call sign, according to the frequency band shown below.

1200 MHz: A (B in Japan)

430 MHz: B (A in Japan)

144 MHz: C (no D-STAR repeaters in Japan)

Message operation

You can store up to 5 short messages in memory, to transmit in the DV mode.

Each message can be up to 20 characters long.

◇ Entering a TX message

Example: To enter “JAPAN >TOM” into message memory number 1.

1. Display the TX Message Edit screen

- ① Touch [MENU].
- ② Touch “TX Message.”
(My Station > TX Message)
 - If the item is not displayed, touch [▲] or [▼] one or more times to select another page.

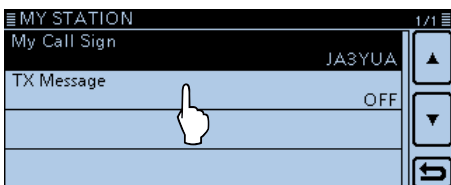

- ③ Touch the desired message memory number field for 1 second. (Example: 1:)

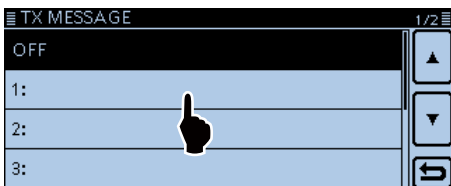

- ④ Touch “Edit.”
 - The “TX MESSAGE” screen appears.

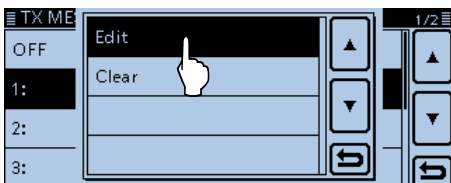

2. Enter the TX message

- ⑤ Touch the keypad.
 - Enters the desired character or symbol.
 - In the Alphabet entry mode, touch “↑” to enter an upper case letter once, or touch “↑↑” to continuously enter upper case letters. Touch “⇩” to enter lower case letters.
 - Touch [[ab]] or [[12]], and then touch [ab], [12] or [(!#)] (symbol) to select the desired entry mode.

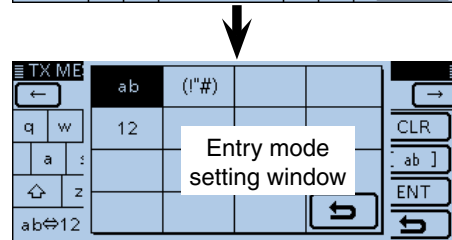
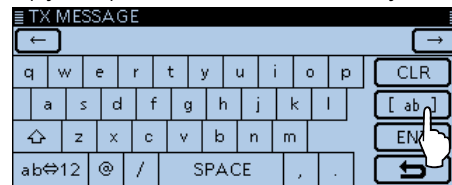

- Touch “ab⇄12” to toggle between the Alphabet entry and Number entry modes.
- Touch “SPACE” to enter a space.
- Touch [CLR] to delete the selected character, symbol or number.
- Touch [QUICK], and then touch “Switch to Tenkey” to switch the keyboard type.

Selectable characters and symbols
A to Z, a to z, 0 to 9, ! " # \$ % & ' () * + , - . / : ; < = > ? @ [\] ^ _ ` { } ~ (space)

Keys used for entry

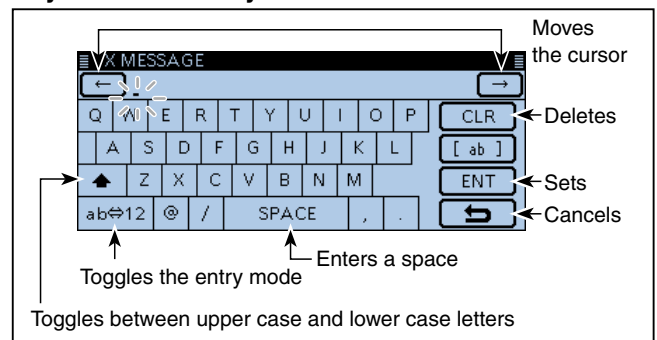

☞ Continued on the next page

Message operation (Continued)

2. Enter the TX message (Continued)

- ⑥ Touch [←] to move the cursor backwards, or touch [→] to move the cursor forwards.
- ⑦ Repeat steps ⑤ and ⑥ to enter a name of up to 20 characters, including spaces.
(Example: First, J, then A, then P, then A, then N, then (space), then >, then T, then O, then M.)
- ⑧ Touch [ENT].
 - Returns to the “TX Message” screen.

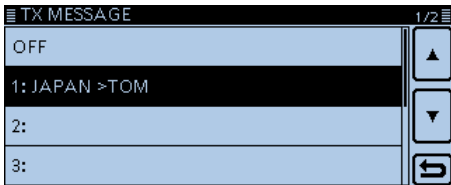
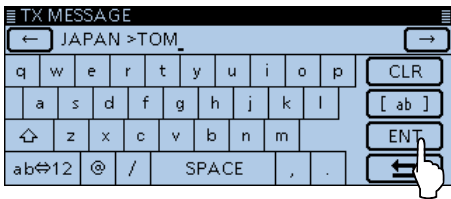

- ⑨ Touch [MENU]
 - Closes the Menu screen.

Message operation (Continued)

◆ Transmitting a message

You can transmit a pre-entered text message by pushing [PTT]. First, select a TX message which also turns ON the message transmission function.

① Touch [MENU].

② Touch "TX Message."

(My Station > TX Message)

- If the item is not displayed, touch [▲] or [▼] one or more times to select another page.

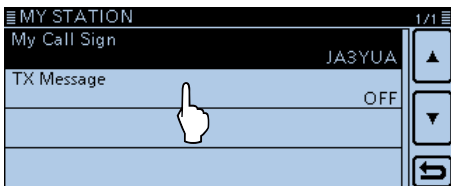

③ Touch the number to select message memory number 1 to 5. (Example: 1: JAPAN >TOM)

- To turn OFF the message transmission function, select "OFF."

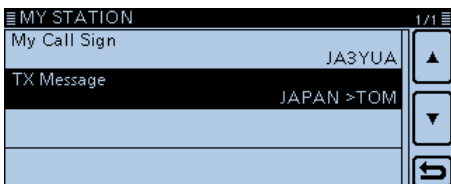
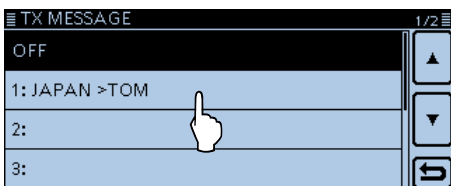

④ Touch [MENU].

- Closes the Menu screen.
- The message is transmitted along with your voice signal.
- The message is transmitted each time you push [PTT].
- The message is automatically transmitted every 30 seconds during continuous transmission.

RX call sign and message display

As the default, the received call sign and message are automatically displayed and scrolled on the LCD. To not display and scroll them, set the "RX Call Sign" item to "OFF" in the Menu screen.

(Display > RX Call Sign)

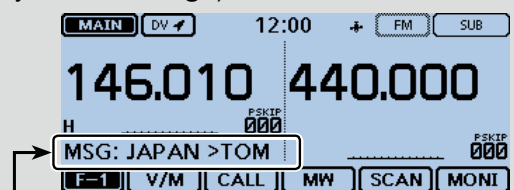

The received call sign and message are displayed and scrolled.

Message operation (Continued)

◇ TX message deleting

The programmed TX message can be deleted, as described below.

Example: To delete the programmed TX message “JAPAN >TOM” from message memory number 1.

- ① Touch [MENU].
- ② Touch “TX Message.”
(My Station > TX Message)
• If the item is not displayed, touch [▲] or [▼] one or more times to select another page.

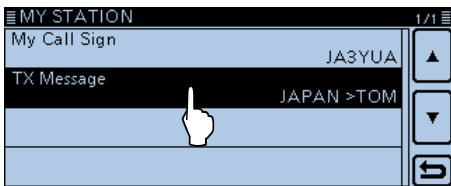

- ③ Touch the desired message memory number for 1 second. (Example: 1: JAPAN >TOM)

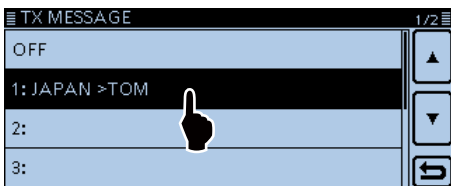

- ④ Touch “Clear.”
• The confirmation window “Clear?” appears.

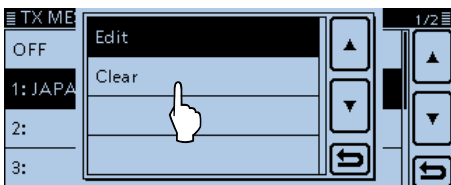

- ⑤ Touch [YES].

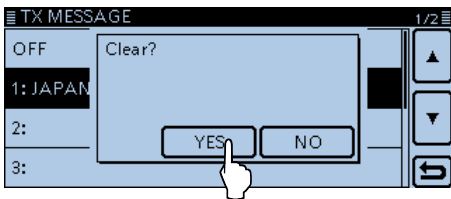

- ⑥ Touch [MENU].
• Closes the Menu screen.

Viewing the received call signs

When you receive a DV call, the calling station and the repeater's call signs are stored in the RX HISTORY screen.

Up to 50 calls can be stored.

When you receive the 51th call, the oldest history will be deleted.

Even if the transceiver is turned OFF, the RX record will not be deleted.

The stored call signs can be displayed in the following manner.

◆ View in the RX History screen

- ① Touch the Function group icon one or more times.
 - Selects the D-1 menu.
- ② Touch [CD]
 - Opens the "RX HISTORY" screen.
- ③ Touch [▲] or [▼].
 - Selects an RX history memory between "RX01" and "RX50."
 - The first page of the "RX HISTORY" screen displays the latest RX record of the MAIN band. The second page or later displays the record according to the received date and time, regardless of the band it was received on.
 - In addition to the RX history number, the call signs of the caller and called station, RX message, Repeater call sign of the called station, received date and time, GW, GPS, GPS information, [RX>CS] and [DETAIL] are displayed on the screen.
 - "GW" appears when the gateway call is received.
 - "GPS" and GPS information appear when the received call includes GPS position.
 - "UP" appears when the repeater uplink signal is received.
 - Touch [RX>CS] to temporary set the received call sign to "TO" field (destination).
- ④ Touch [DETAIL]
 - Displays the contents of the RX history.

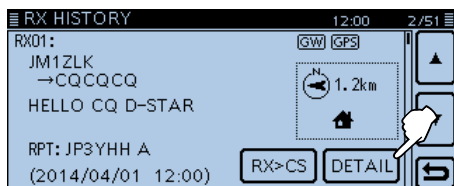

RX HISTORY screen (RX01)

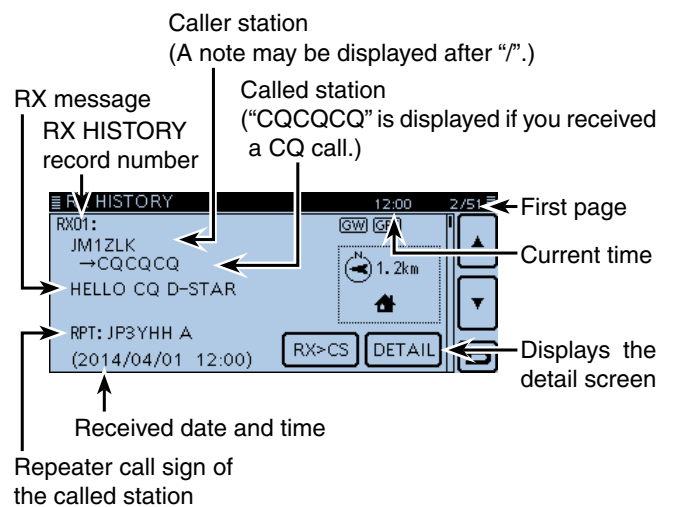

D-PRS TX format icon

- GPS: Displayed when a D-PRS TX format is 'Position.'
- OBJ: Displayed when a D-PRS TX format is 'Object.'
- ITEM: Displayed when a D-PRS TX format is 'Item.'
- WX: Displayed when a D-PRS TX format is 'Weather.'

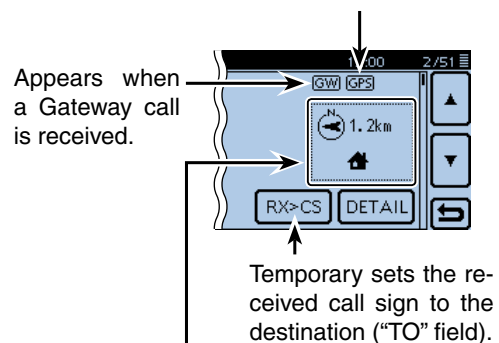

D-PRS information

- Direction (compass)
- Distance from the called station
- D-PRS symbol

Viewing the received call signs (Continued)

⑤ Touch [▲] or [▼].

- Selects another page.

[First page]

- **CALLER:** Displays the call sign of the caller station and any note programmed after the call sign.
- **CALLED:** Displays the call sign of the called station.



[Second page]

- **RXRPT1:** Displays the call sign of the repeater that was accessed by the caller station. If it was a call through a gateway and the internet, this item displays the gateway call sign of the repeater you received the call from.
- **Rx RPT2:** Displays the call sign of the repeater you received the call from.

⚡ "FREQUENCY" appears instead of these items when the call was not through a repeater (Simplex call), to show the frequency that was used.

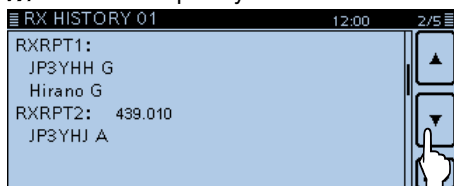

[Third page]

- **MESSAGE:** Displays any message included in the received call, if programmed.
- **RX TIME:** Displays the date and time the call was received.

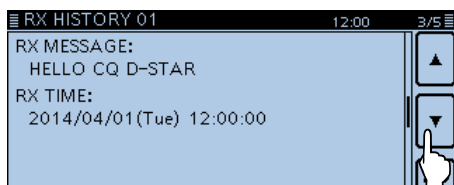

[Fourth page], [Fifth page]

Displays the position of the caller station. If a received signal has no data, then no position is displayed.

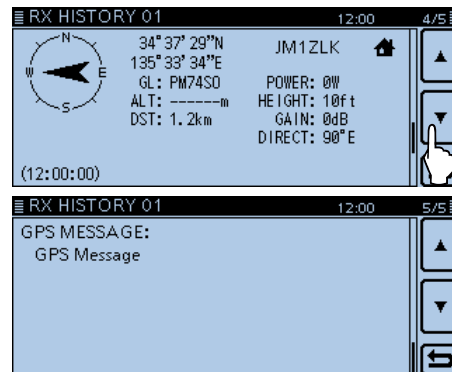

⑥ Touch [MENU].

- Closes the Menu screen.

You can delete the RX HISTORY data.

➔ Touch the RX HISTORY or the contents screen for 1 second, or touch [QUICK], then select "Delete."

For your information

"RX RPT1" setting may differ, depending on the way the call was made.

Example: When a Local area call is received.

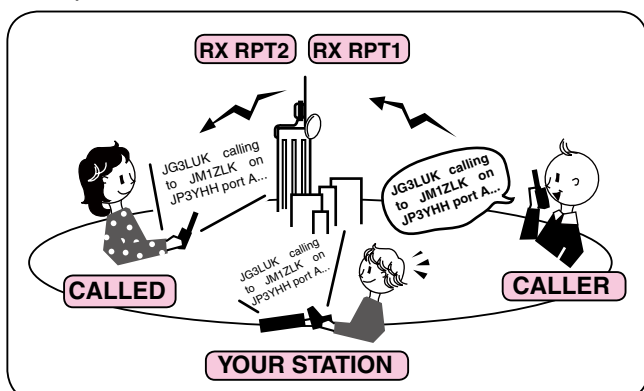

Example: When a Gateway call is received.

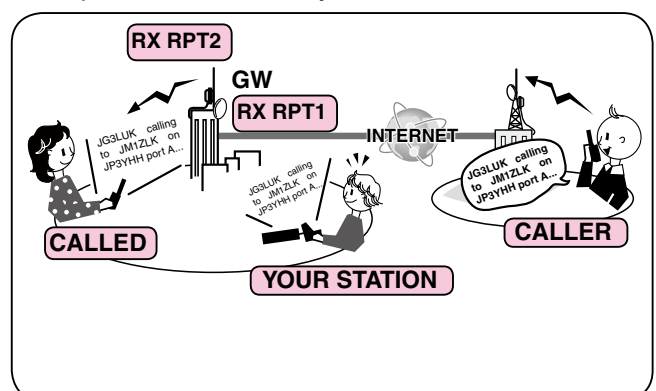

BK mode communication

The BK (Break-in) function allows you to break into a conversation, where the two other stations are communicating with call sign squelch enabled. (Default: OFF)

NOTE: The BK function is automatically turned OFF when transceiver is turned OFF.

- ① While two other stations are communicating in the DV mode, touch [RX>CS] for 1 second.
 - After releasing, beeps sound and the calling station call sign is announced. (RX>CS Speech function)
 - The calling station or call sign of the repeater used is automatically set.
 - When a call sign is not received correctly, error beeps sound, and no call sign is set.

② Touch [MENU].

③ Touch "BK."

(DV Set > BK)

- If the item is not displayed, touch [▲] or [▼] one or more times to select another page.

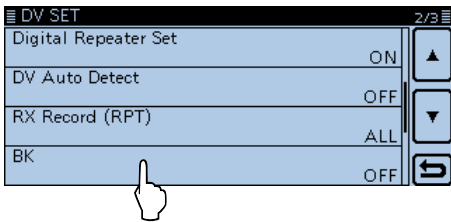

④ Touch "ON."

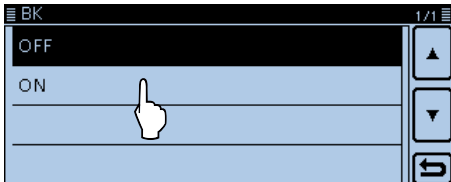

⑤ Touch [MENU].

- Closes the Menu screen.
- "BK" appears.

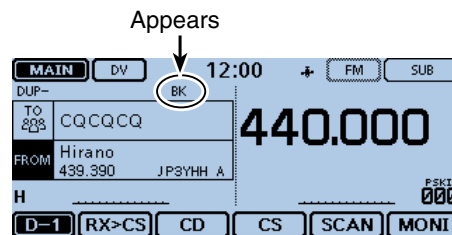

⑥ When both stations are in standby, push [PTT] to transmit.

- The LED1 on the microphone lights red.
- "BK" blinks on the station that receives the break-in call.

⑦ Release [PTT] to receive.

Wait for a reply call from the station.

⑧ After receiving the reply call, communicate normally.

⑨ To cancel the BK mode, select "OFF" in the "BK" item as step ④, or turn OFF the power.

How to use Break-in?

While using digital call sign squelch, the squelch never opens (no audio is heard) even if a call is received, unless your own call sign is specified.

However, when a call including the "BK ON" signal (break-in call) is received, the squelch will open and audio is heard even if the call is specified for another station.

• Station C calling to Station A with "BK OFF"

Station A and B are communicating using digital call sign squelch.

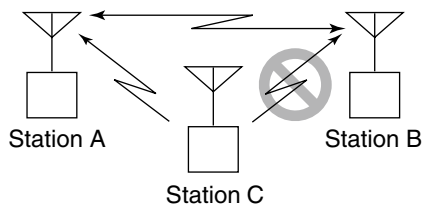

Station B never hears that Station C is calling Station A.

• Station C calling to Station A with "BK ON"

Station A and B are communicating using digital call sign squelch.

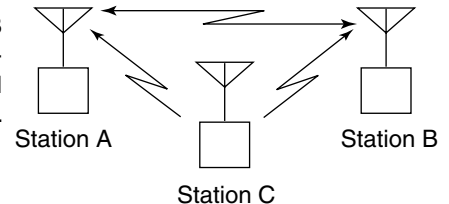

Station B also hears that Station C is calling Station A.

EMR communication

The EMR (Enhanced Monitor Request) communication function can be used in only the DV mode. Using the EMR function, no call sign setting is necessary. All transceivers that receive an EMR signal automatically open their squelch to receive the signal. When an EMR signal is received, the audio (voice) will be heard at the specified level, even if the volume setting level is set to the minimum level, or the digital call sign/digital code squelch is in use. (Default: OFF)

NOTE: The EMR communication function is automatically turned OFF when the transceiver is turned OFF.

Example: To transmit from the “Hirano” repeater using the EMR function.

- ① Touch [MENU].
- ② Touch “EMR.”
(DV Set > **EMR**)
 - If the item is not displayed, touch [▲] or [▼] one or more times to select another page.

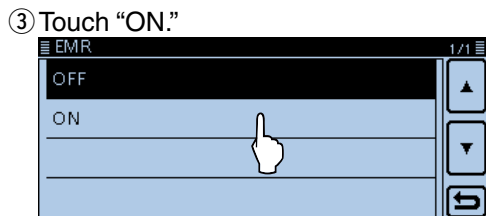
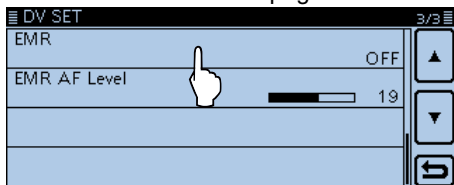

- ④ Touch [MENU].
 - Closes the Menu screen.
 - “EMR” appears.

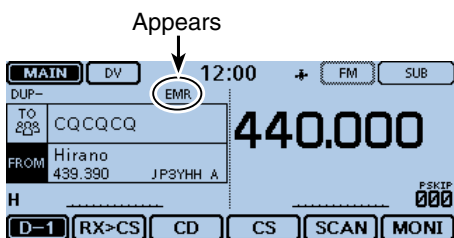

- ⑤ Push [PTT] to transmit.
 - The LED1 on the microphone lights red.
 - “EMR” blinks on a station that receives the EMR signal. The audio (voice) will be heard at the specified level, or the [VOL] control level, whichever is higher.
- ⑥ Release [PTT] to receive.
- ⑦ To cancel the EMR function, select “OFF” in step ③, as described above, or turn OFF the power.

◇ Adjusting the EMR AF level

The audio output level when an EMR signal is received is adjustable between 0 and 32. When an EMR signal is received, the audio will be heard at the preset level, or the [VOL] control level, whichever is higher. To disable the setting, set it to “0.”

- ① Touch [MENU].
- ② Touch “EMR AF Level.”
(DV Set > **EMR AF Level**)
 - If the item is not displayed, touch [▲] or [▼] one or more times to select another page.

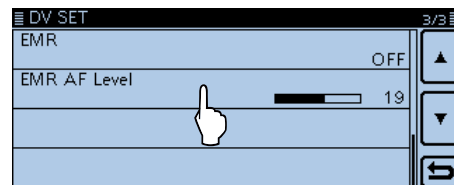

- ③ Touch [+] or [-] one or more times to adjust the EMR audio output level between 0 (minimum) and 32 (maximum) in single digit steps. (Default: 19)

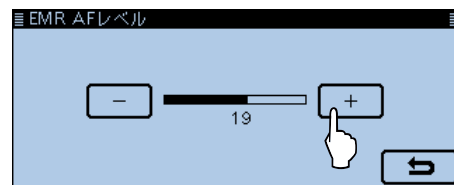

- ④ Touch [MENU].
 - Closes the Menu screen.

Display type setting

You can change the letter size in the DR screen, such as a repeater name, call sign, and so on to see the letters better. (Default: Normal)

- ① Touch [QUICK].

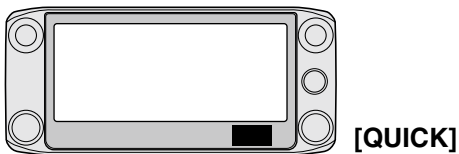

- ② Touch "Display Type."

- If the specified item is not displayed, touch [▲] or [▼] one or more times to select the page.

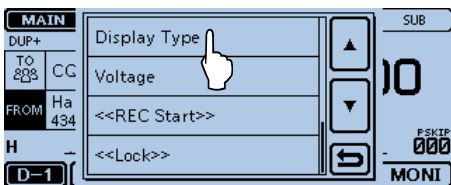

- ③ Touch "Large."

- The display size changes to the same size as the repeater name set in "TO" and "FROM."

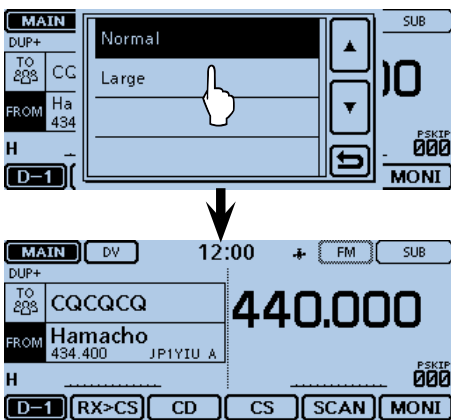

Automatic DV detection

If you receive an FM signal while in the DV mode, the “DV” and “FM” icons alternately blink to indicate the received signal is FM.

When the DV Auto Detect function is turned ON, the transceiver automatically selects the FM mode to temporarily monitor the signal. (Default: OFF)

- Regardless of this setting, the “DV” and “FM” icons alternately blink if you receive an FM signal while in the DV mode.

For your reference:

When digital call sign squelch (DSQL) or digital code squelch (CSQL) is selected, the transceiver does not receive FM signals, even if this function is ON. You can silently wait for calls from others.

- ① Touch [MENU].
- ② Touch “DV Auto Detect.”
(DV Set > DV Auto Detect)
• If the item is not displayed, touch [▲] or [▼] one or more times to select another page.

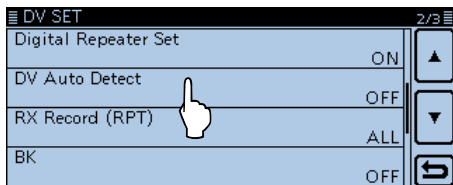

- ③ Touch “ON.”

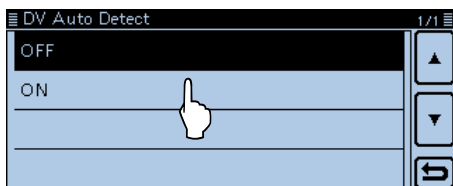

- ④ Touch [MENU].
• Closes the Menu screen.
• When an FM signal is received while in the DV mode, the “DV” and “FM” icons sequentially blink, and the transceiver receives the signal in the FM mode.

<When an FM signal is received while in the DV mode>

- DV Auto Detect function: OFF

The “DV” and “FM” icons alternately blink, but the audio cannot be heard.

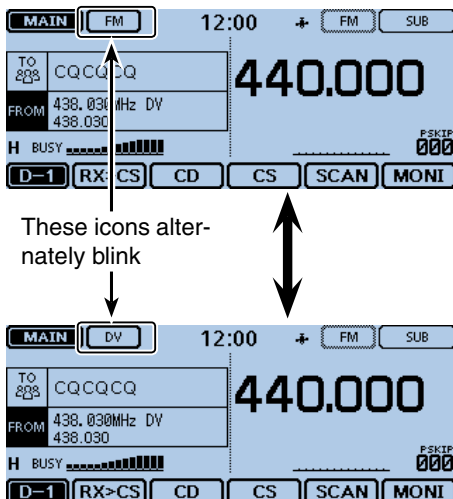

These icons alternately blink

The audio cannot be heard.

- DV Auto Detect function: ON

The “DV” and “FM” icons alternately blink, and the audio can be heard.

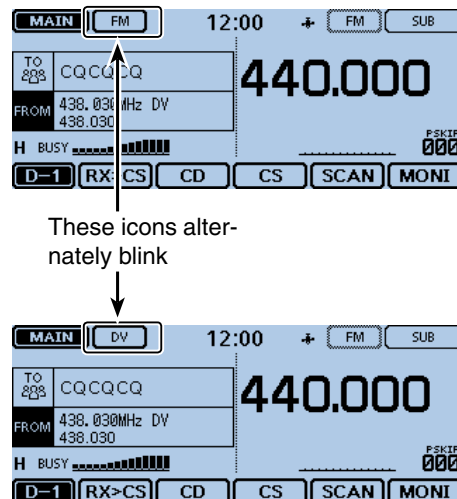

These icons alternately blink

Thanks for the nice QSO...

The audio can be heard.

Automatic Reply function

When a call addressed to your own call sign is received, the Automatic Reply function automatically replies with your call sign. (Default: OFF)

Depending on the setting, a recorded message may be transmitted with the call sign.

① Touch [MENU].

② Touch "Auto Reply."

(DV Set > **Auto Reply**)

- If the item is not displayed, touch [▲] or [▼] one or more times to select another page.

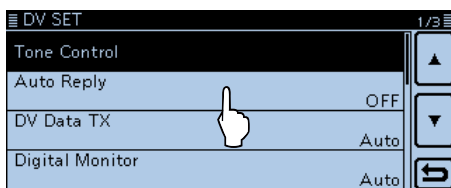

③ Touch the desired option.

- **ON:** Replies with your own call sign. (No audio reply is sent)
- **Voice:** Replies with your call sign and any Auto Reply message recorded on the SD (up to 10 seconds).

If no SD card is inserted, or no message is recorded, replies with your own call sign. (No audio reply is sent)

• **Position (Main Only):**

Replies with your own call sign and transmits your position using the internal GPS receiver.

While in the Dualwatch mode, automatically replies only when the signal is received in the MAIN band.

- When the "GPS Select" item is set to "OFF" or "Manual," the internal GPS receiver is temporarily turned ON.

• **Position (Main/Sub):**

Replies with your own call sign and transmits your position using the internal GPS receiver.

While in the Dualwatch mode, automatically replies when the signal is received in either the Main or Sub band.

- When the "GPS Select" item is set to "OFF" or "Manual," the internal GPS receiver is temporarily turned ON.

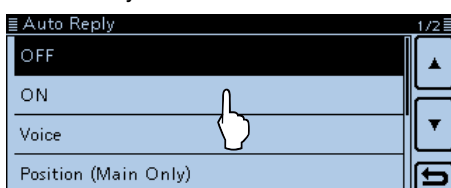

④ Touch [MENU].

- Closes the Menu screen.
- "440.000" appears.

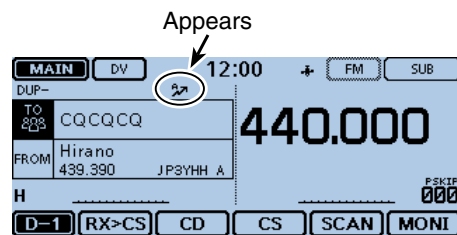

When "ON" or "Voice" is selected, the Automatic Reply function is automatically turned OFF, when you push [PTT]. When "Position (Main Only)" or "Position (Main/Sub)" is selected, the Automatic Reply function remains ON, when you push [PTT].

After receiving a call from "JM1ZLK," the transceiver automatically sends a reply call.

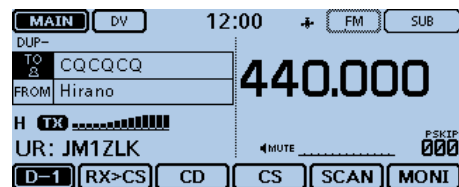

The "TO" setting does not change, but "UR: JM1ZLK (Caller's call sign)" is displayed.

NOTE: The Automatic Reply function temporary sets the received call sign to the destination call sign.

To record the voice signal

You can record a voice announcement for the Auto Reply function in "DV Auto Reply" on the Set mode. (p. 12-18)

(Voice Memo > **DV Auto Reply**)

Automatic Reply function (Continued)

◇ Recording an Auto Reply voice announcement

The Auto Reply voice announcement can be recorded and saved on an SD card to reply to the call with your voice.

NOTE: Be sure to insert an SD card to the [SD] slot of the transceiver before starting to record a voice announcement.

- ① Touch [MENU].
- ② Touch “DV Auto Reply.”
(Voice Memo > DV Auto Reply)
• If the item is not displayed, touch [▲] or [▼] one or more times to select another page.

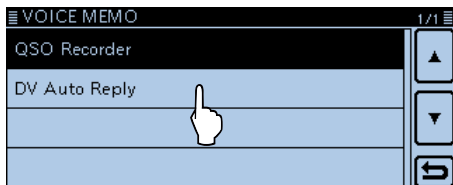

- Touch [MIC GAIN] to open the “MIC GAIN” setting window.

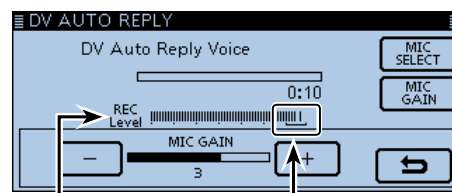

Audio level is displayed
Adjust the Mic gain so that the REC Level does not reach to this range

- ③ Touch [●].
• Starts recording.

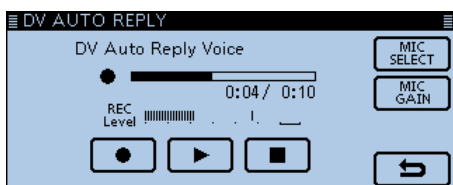
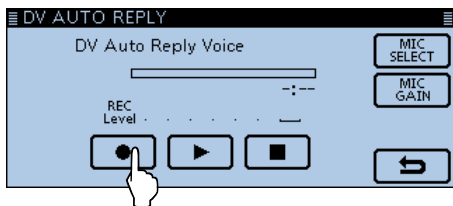

Recording

- Touch [■] to stop recording.
- Touch [▶] to start the playback.

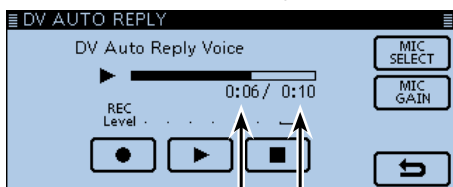

While playing Playing time Recording time

- Maximum record time is 10 second
- Hold the microphone 5 to 10 cm (2 to 4 inches) from your mouth, then speak at a normal voice level.
- Only one announcement can be recorded. The current contents will be overwritten if you record again.

- ④ Touch [MENU].
• Closes the Menu screen.

You can delete the recorded audio.
➔ On the “DV AUTO REPLY” screen, touch [QUICK], and then touch “Clear.”

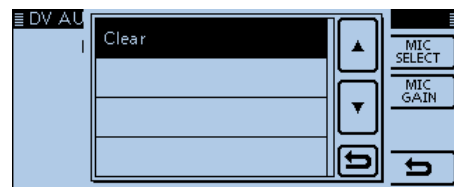

You can record your voice with the optional VS-3 Bluetooth® HEADSET.

- ➔ On the “DV AUTO REPLY” screen, touch [MIC SELECT], and then touch “Bluetooth MIC.”

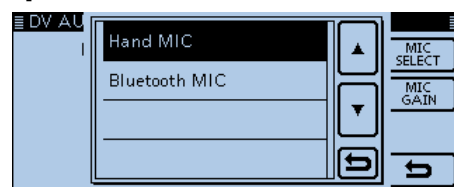

Automatic Reply function (Continued)

◇ Auto Position Reply function

When you receive a call addressed to your own call sign, but are in a situation that makes it difficult to operate the transceiver, this function automatically replies with your own call sign and transmits your position.

After receiving the Auto Position Reply call, your position is displayed on the screen of the called station.

- Icom transceivers prior to the ID-5100A/E do not show the position after receiving a call. (ID-31A/E, IC-9100, ID-880H/E880, IC-80AD/E80D, IC-92AD/E92D, IC-2820H/E2820, ID-800H, IC-91AD/E91, IC-V82, IC-U82)
- The called station's position window can be turned OFF in the Menu screen. (Display > **RX Position Display**) (p. 12-58)

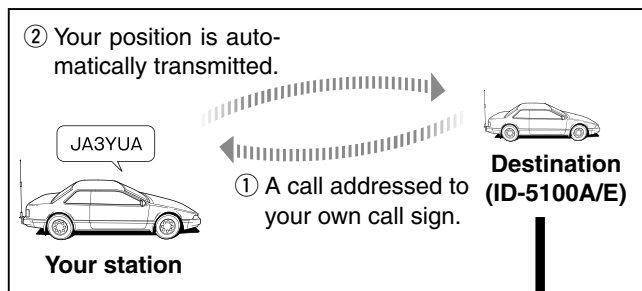

③ After receiving, the screen shows the position.

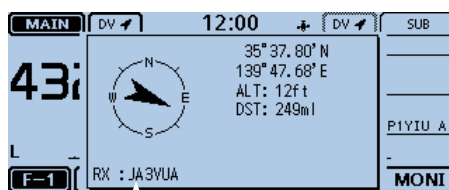

- Scrolls your call sign or the TX message.
- Your status message may be displayed.

After receiving the Auto Position Reply call, the destination screen shows your position.

• When no valid position data is received

After receiving a call addressed to your own call sign, even if the “GPS Select” item is set to “OFF” or “Manual,” the internal GPS receiver is temporarily turned ON for approximately 5 minutes to receive your position. Then, the transceiver automatically replies with a message, as described below.

When the internal GPS receiver is temporarily turned ON, and valid data is received, the transceiver automatically replies if a call addressed to your own call sign is received again.

• Reply message list when no valid position data is received

Message	Status
No Position	When no position is received.
Old Position	2 minutes or more has passed since receiving position data.
No Posi & GPS Start	The internal GPS receiver is temporarily turned ON, but has not received your position data yet.
Old Posi & GPS Start	The internal GPS receiver is temporarily turned ON, and 2 minutes or more has passed since receiving the position data.

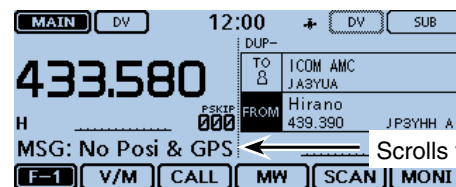

Scrolls your message

After receiving the Auto Position Reply call, the destination screen shows your message.

NOTE:

- The position data is transmitted according to the GPS TX mode. (p. 12-20)
- When the GPS TX mode settings are incorrect for the Automatic Reply function, the transceiver automatically corrects them to reply to a call.
- When the GPS transmission mode is OFF, “D-PRS” is automatically selected.

Low-speed data communication

In addition to digital voice communication, low-speed data communication can be made.

Use the optional data communication cable and a serial data communication software (third-party's).

◇ Connection

Connect the transceiver to your PC using the data communication cable, as shown below.

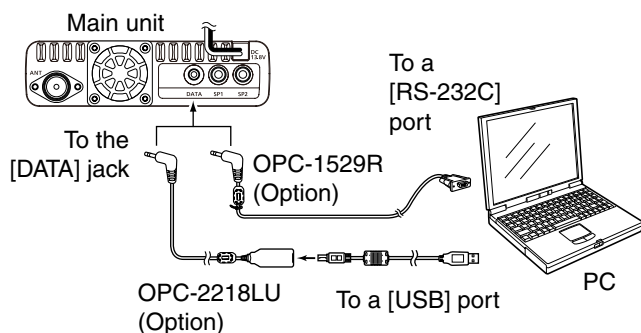

Terminal information

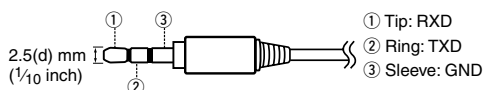

◇ Low-speed data communication application setting

Configure the communication software as follows.

- Port: The COM port number that is used by the ID-5100A/E.*1
- Baud rate: 4800/9600 bps*2
- Data: 8 bit
- Parity: none
- Stop: 1 bit
- Flow control: Xon/Xoff

*1 Depending on the PC environment, the COM port number used by the ID-5100A/E may be higher than 5. In such case, use an application that can set it to higher than 5.

*2 Set the baud rate in the "Data Speed" item. (p. 12-56)
(Function > **Data Speed**)

◇ Low-speed data communication

- ① Set your own call sign, UR call sign and the repeater call sign you want to use.
- ② Follow the instructions of the communication software.
- ③ When you enter text data into your communication software, the transceiver automatically transmits it.
 - Push [PTT] to transmit the data and a voice signal when the "DV Data TX" item is set to "PTT" in the Menu screen. (p. 12-44)
(DV Set > **DV Data TX**)
 - Before transmission, the carrier sense function activate to check signals.

Before starting low-speed data communication:

The "DV Data TX" item is set to "Auto" by default. So, depending on your communication software, the transceiver may automatically transmit the data only when you unintentionally enter text on the software screen.

NOTE: Before starting, set the "GPS Out" item to "OFF." (p. 12-20)
(GPS > GPS Set > **GPS Out (To DATA Jack)**)

NOTE:

- Only the ASCII code can be used for the low-speed data communication.
- A message of up to 20 characters can be transmitted with a DV voice signal. (p. 7-2, p. 7-3)
- Depending on the combination of your PC and your communication software, some data may be lost.
- While receiving voice communication or low-speed data communication through the internet, some packets may be lost due to network error (poor data throughput performance). In such a case, an "L" appears on the screen to indicate the Packet Loss has occurred.

Digital squelch functions

The digital squelch opens only when you receive a signal addressed to your own call sign, or a signal that includes a matching digital code.

You can silently wait for calls from others.

You can independently set the Digital squelch function in the VFO mode, Memory mode, CALL channel mode, or DR function.

◆ The digital call sign squelch setting

- ① Touch [DR].
 - Opens the DR screen.
- ② Touch the Function group icon one or more times.
 - Selects the D-3 menu.
- ③ Touch [DSQL].

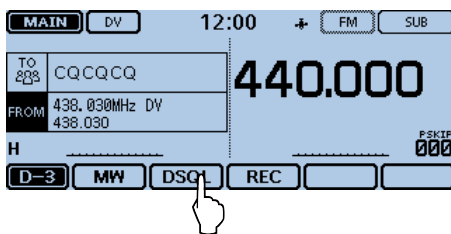

- ④ Touch “DSQL ((·))” or “DSQL”.
 - DSQL ((·)): Turns ON the digital call sign squelch function with the Pocket beep.
 - “DSQL ((·))” appears.
 - DSQL: Turns ON the digital call sign squelch function.
 - “DSQL” appears.

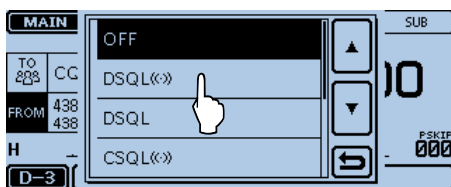

Appears

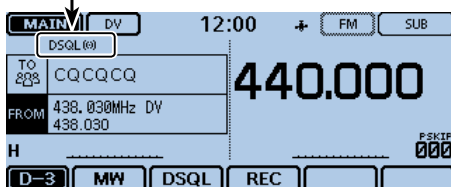

When the received signal includes a matching call sign, the squelch opens and you can hear the audio.

- When the received signal does not include a matching call sign, the digital call sign squelch does not open. However, the S/Rf meter displays the received signal level.

◆ Digital call sign squelch function with a Pocket beep

When a received signal is addressed to your own call sign, the beeps sound for 30 seconds and an “((·))” blinks.

Within 30 seconds, push [PTT] to answer, or touch the screen to stop the beeps and turn OFF the Pocket beep function.

- “((·))” disappears.

If you make no operation for 30 seconds, the beeps automatically stop, but “((·))” continues to blink to indicate that you received a call.

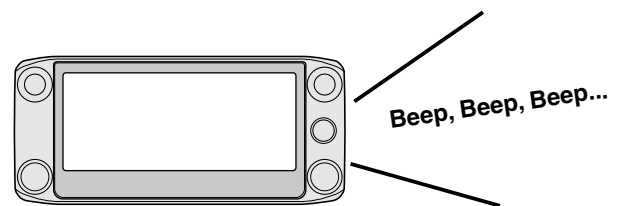

NOTE:

- **DO NOT** use the digital call sign squelch function when communicating with two or more stations, because the digital call sign squelch function opens only when receiving a signal addressed to your own call sign. Thus the digital call sign squelch function can be used when communicating with only one station.
- Even if the squelch closes by the digital call sign squelch function, you can receive the low-speed data.

Digital squelch functions (Continued)

◇ **The digital code squelch setting**

- ① Touch [DR].
 - Opens the DR screen.
- ② Touch the Function group icon one or more times.
 - Selects the D-3 menu.
- ③ Touch [DSQL].

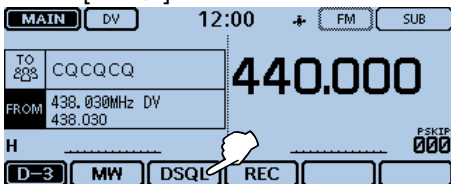

- ④ Touch “CSQL ((·))” or “CSQL”.
 - CSQL ((·)) : Turns ON the digital code squelch function with the Pocket beep.
 - “CSQL ((·))” appears.
 - CSQL: Turns ON the digital code squelch function.
 - “CSQL” appears.

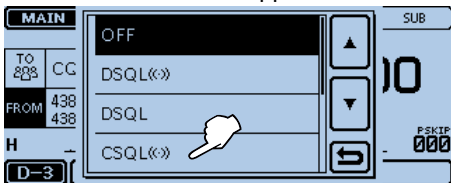

Appears

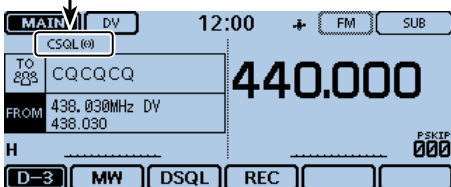

- ⑤ Touch [MENU].
- ⑥ Touch “Digital Code.” (DUP/TONE... > Digital Code)



- ⑦ Touch [+] or [-] one or more times to select the digital code.

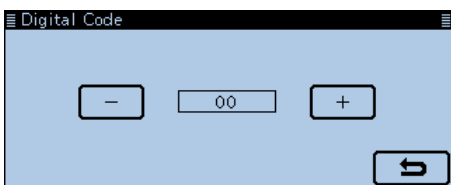

- ⑧ Touch [MENU].
 - Closes the Menu screen.

When the received signal includes a matching code, the squelch opens and you can hear the audio.

- When the received signal does not include a matching code, the digital code squelch does not open. However, the S/Rf meter displays the signal level.

◇ **Digital code squelch function with a Pocket beep**

When a received signal matches your digital code, beeps sound for 30 seconds and an “((·))” blinks. Within 30 seconds, push [PTT] to answer, or touch the screen to stop the beeps and turn OFF the Pocket beep function.

- “((·))” disappears.
- If you make no operation for 30 seconds, the beeps automatically stop, but “((·))” continues to blink to indicate that you received a call.

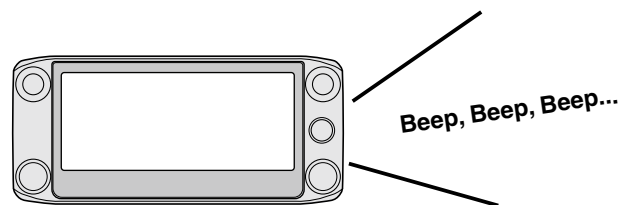

NOTE:
Even if the squelch closes by the digital code squelch function, you can receive the low-speed data.

Viewing the call signs

While in the DV mode, displays the “CALL SIGN” screen in the F-4 menu.

- ① Touch the Mode icon.
 - Opens the operating mode setting window.
- ② Touch [DV].
 - Selects the DV mode.
- ③ Touch the Function group icon one or more times.
 - Selects the F-4 menu.
 - When the DR screen is displayed, select the D-1 menu.
- ④ Touch [CS].
 - Displays the “CALL SIGN” screen.
- ⑤ Touch [↵].
 - Exits the “CALL SIGN” screen.

While operating D-STAR in the Memory mode.

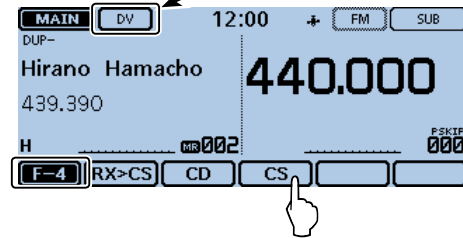

	CALL SIGN	
Destination call sign	UR: /JP1YIUA	Hamacho
Access repeater call sign	R1: JP3YHH A	Hirano
Gateway repeater call sign	R2: JP3YHH G	Hirano G
Your own call sign	MY: JA3YUA	

Two band monitoring in the DV mode

The transceiver can simultaneously monitor two different frequencies in the DV mode.

For example, while operating in the Simplex mode on the MAIN band, you can also monitor a D-STAR repeater on the SUB band.

- While receiving or transmitting a DV signal on the MAIN band, DV mode audio from the SUB band will be muted.

- When no signal is received on the MAIN band, you can receive a signal on the SUB band.
- While receiving a DV signal on both the MAIN and SUB bands at the same time, you can hear only the MAIN band audio.
(The SUB band audio will be muted. In this case, "MUTE" is displayed, but the S-meter and the received call sign will be displayed.)

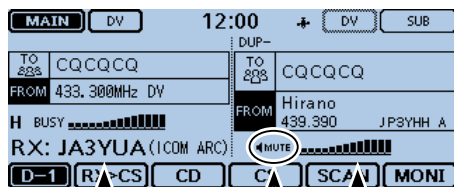

MAIN band
(You can hear the received audio)

Appears
SUB band
(The received audio is muted.)

The received DV call data is stored in the RX history file, regardless of the band it was received on.

When a signal is received on the MAIN band, while receiving on the SUB band:

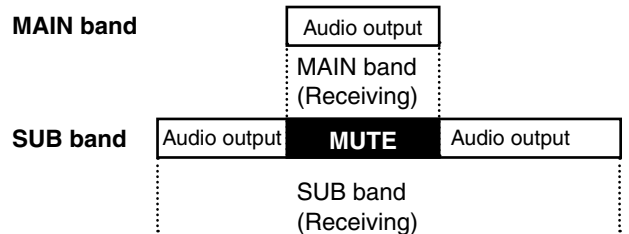

When a signal is received on the MAIN band, while receiving on the SUB band, you can hear only the MAIN band audio.

After disappearing the signal on the MAIN band, you can hear the SUB band audio.

When a signal is received on the SUB band, while receiving on the MAIN band:

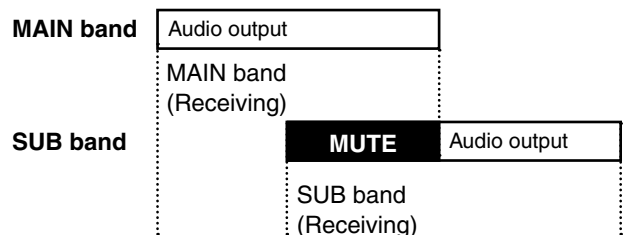

Even if a signal is received on the SUB band, while receiving on the MAIN band, you cannot hear the SUB band audio.

After the signal on the MAIN band disappears, you can hear the SUB band audio.

Repeater list

You can store repeater information for quick and simple communication in up to 1200 repeater memory channels (Repeater list) in up to 30 Groups.

Entering data into the repeater list is required to use the DR function.

You can enter four types of frequencies into the repeater list, as shown below:

- DV repeater
- DV simplex
- FM repeater
- FM simplex

◇ Repeater list contents

The following contents are included in the repeater list:

- TYPE (Frequency type) (p. 7-22)
- NAME (Repeater name) (p. 7-22)
- SUB NAME (Repeater sub name) (p. 7-22)
- CALL SIGN (Repeater call sign and port letter) (p. 7-22)
- GW CALL SIGN (Gateway repeater's call sign and port "G") (p. 7-23)
- GROUP (Repeater group) (p. 7-23)
- USE(FROM) (Access repeater use) (p. 7-23)
- FREQUENCY (Access repeater's input frequency) (p. 7-23)
- DUP (Duplex direction) (p. 7-23)
- OFFSET FREQ (Frequency offset) (p. 7-23)
- MODE (p. 7-23)
- TONE (p. 7-24)
- Repeater Tone (p. 7-24)
- POSITION (Position data accuracy level) (p. 7-24)
- LATITUDE (Latitude of the repeater) (p. 7-24)
- LONGITUDE (Longitude of the repeater) (p. 7-24)
- UTC OFFSET (UTC Offset) (p. 7-24)

NOTE: For easy operation, the repeater list is pre-loaded into your transceiver. However, if you do an All Reset, the CPU clears all the setting data, the memory channels and the repeater list.

We recommend that you back up the memory data to a SD card or save it to a PC using the CS-5100 CLONING SOFTWARE.

About the repeater list:

The repeater list can be downloaded from the Icom website.

<http://www.icom.co.jp/world/support/download/firm/index.html>

Example: "Hirano" repeater information

REPEATER LIST (DV Repeater)		1/2
Type	: DV Repeater	▲ ▼ ↺
NAME	: Hirano	
SUB NAME	: Osaka	
CALL SIGN	: JP3YHH A	
GW CALL SIGN	: JP3YHH G	
GROUP	: 11 Japan	
USE(FROM)	: YES	

REPEATER LIST (DV Repeater)		2/2
FREQUENCY	: 439.390.00	▲ ▼ ↺
DUP	: DUP-	
OFFSET FREQ	: 5.000.00	
POSITION	: Approximate	
LATITUDE	: 34°37.55'N	
LONGITUDE	: 135°34.09'E	
UTC OFFSET	: +9:00	

Entering new information into the Repeater List

This section describes how to manually enter new repeater information into the repeater list.

The required setting items differ, depending on your communication usage. Be sure to confirm the required items, as shown below.

NOTE: To enter repeater information into the repeater list, the repeater's call sign **MUST** be entered first.

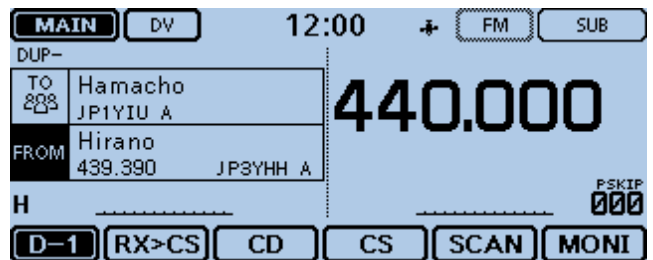

◇ Required items for the communication cases

Repeater list contents	Used as an access repeater	Used as a destination repeater	Used for DV simplex	Used as an FM repeater	Used for FM simplex
TYPE	DV Repeater	DV Repeater	DV Simplex	FM Repeater	FM Simplex
NAME	○	○	○	○	○
SUB NAME	○	○	○	○	○
CALL SIGN	●	●	N/A	○	N/A
GW CALL SIGN (For a Gateway call)	●	●	N/A	N/A	N/A
GROUP	○	○	○	○	○
USE(FROM)	●	○	●	○	○
FREQUENCY	●	○	●	●	●
DUP	●	○	N/A	○	N/A
OFFSET FREQ	●	○	N/A	○	N/A
MODE	N/A	N/A	N/A	○	○
TONE	N/A	N/A	N/A	○	○
RPT TONE	N/A	N/A	N/A	○	○
POSITION	○	○	○	○	○
LATITUDE	○	○	○	○	○
LONGITUDE	○	○	○	○	○
UTC OFFSET	○	○	○	○	○

●: Must be entered
 ○: Possible to enter
 N/A: Not Available

Entering new information into the Repeater List (Continued)

◇ Entering new information into the repeater list

1. Selecting the repeater group

- ① Touch [MENU].
- ② Touch "Repeater List."
(DV Memory > **Repeater List**)
 - If the item is not displayed, touch [▲] or [▼] one or more times to select another page.
 - Displays the repeater groups.
- ③ Touch a desired repeater group to add a repeater to.
 - Displays the repeater list of the selected repeater group.
- ④ Touch a repeater for 1 second.
 - A new repeater will be added below the selected repeater.
- ⑤ Touch [Add].
 - The "REPEATER LIST EDIT (DV Repeater)" screen is displayed.

2. Selecting the communication type

- ⑥ Touch [TYPE].
- ⑦ Touch the desired type.
 - DV Repeater: Repeater operation in the DV mode.
 - DV Simplex: Simplex operation in the DV mode.
 - FM Repeater: Repeater operation in the FM mode.
 - FM Simplex: Simplex operation in the FM mode.

3. Entering the repeater name

- ⑧ Touch "NAME."
• Enters the repeater name edit mode.
- ⑨ Touch the keypad.
 - Enters the desired character or symbol.
 - In the Alphabet entry mode, touch "↑" to enter an upper case letter once, or touch "▲" to continuously enter upper case letters. Touch "▼" to enter lower case letters.
 - Touch [[ab]] or [[12]], and then touch [ab], [12] or [(!"#)] to select the desired entry mode.

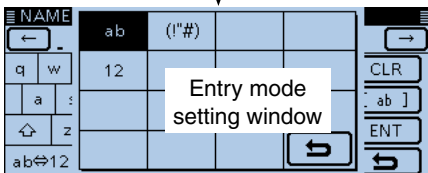
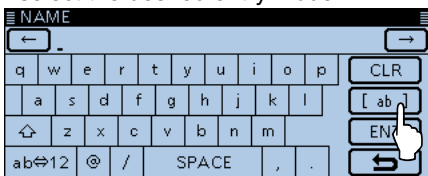

- Touch "ab⇄12" to toggle between the Alphabet entry and Number entry modes.
- Touch "SPACE" to enter a space.
- Touch [CLR] to delete the selected character, symbol or number.
- Touch [QUICK], and then touch "Switch to Tenkey" to switch the keyboard type.

Selectable characters and symbols
A to Z, a to z, 0 to 9, ! " # \$ % & ' () * + , - . / : ; < = > ? @ [\] ^ _ ` { } ~ (space)

- ⑩ Touch [←] to move the cursor backwards, or touch [→] to move the cursor forwards.
- ⑪ Repeat steps ⑨ and ⑩ to enter a name of up to 16 characters, including spaces.
- ⑫ After entering, Touch [ENT].

4. Entering the repeater sub name

- ⑬ Touch "SUB NAME."
 - Enters the repeater sub name edit mode.
 - Enter a sub name of up to 8 characters, including spaces. See '3. Entering the repeater name' for entry details.
- ⑭ After entering, touch [ENT].

5. Entering the repeater call sign

When used for simplex communication, go to '8. Setting "USE(FROM)" to be used as an Access repeater.'

- ⑮ Touch "CALL SIGN."
 - Enters the repeater call sign edit mode.
- ⑯ Touch the desired keypad to select the first digit.
 - A to Z, 0 to 9, / and (Space) are selectable.
 - Touch "ab⇄12" to toggle between the Alphabet entry and Number entry modes.
 - Touch [CLR] to delete the selected character, symbol or number.
 - Touch "SPACE" to enter a space.
 - Touch [QUICK], and then touch "Switch to Tenkey" to switch the keyboard type.

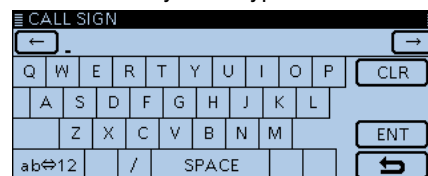

- ⑰ Touch [←] to move the cursor backwards, or touch [→] to move the cursor forwards.
- ⑱ Repeat steps ⑯ and ⑰ to enter your call sign of up to 8 characters, including spaces.
- ⑲ After entering, touch [ENT].
- ⑳ Touch [▼].

✓ Information

Be sure to add the repeater node letter in the 8th digit of the call sign, according to the frequency band shown below. Note that there are different node letters between Japanese D-STAR repeaters and repeaters in other countries.

- 1200 MHz: A (B in Japan)
- 430 MHz: B (A in Japan)
- 144 MHz: C (no D-STAR repeaters in Japan)

Cross band operation between different nodes at the same repeater site can be made.

Continued on the next page.

Entering new information into the Repeater List

◇ Entering new information into the repeater list (Continued)

6. Entering the gateway repeater call sign

- This item appears when '2. Selecting the communication type' is set to "DV Repeater."
- The 8th digit in the call sign, entered in '5. Entering the repeater call sign' as described on page 7-22, is automatically set to "G" as the gateway port, so you can skip this setting and go to the next item. If you need to change it, follow the steps, described below.

- ⑳ Touch "GW CALL SIGN."
- Enters the gateway repeater call sign edit mode.
 - A cursor appears and blinks.
 - Enter a gateway repeater call sign of up to 8 characters, including spaces. See '5. Entering the repeater call sign' for details.

To enter a space and "G" in the 8th digit, touch [GW].

- ㉑ After entering, touch [ENT].

7. Changing the repeater group

- You can view the repeater group that is selected in '1. Selecting the repeater group,' or you can skip this setting and go to the next item.
- You can change the repeater group, if necessary.

- ㉒ Touch "GROUP."
- Enters the repeater group selection mode.
- ㉓ Touch the desired repeater group, 01 to 30.

8. Setting "USE(FROM)" to be used as an Access repeater

- You can use the programmed repeaters as an access repeater when using the DR function.
- When not using as an access repeater, select "NO," and go to '15. Selecting the position data accuracy level.'
- In this case, the entered repeater does not appear in the "FROM" field.

- ㉔ Touch "USE(FROM)."
- ㉕ Touch "YES" to use the repeater as an access repeater.

9. Entering the access repeater frequency

- ㉖ Touch "FREQUENCY."
- Enters the frequency edit mode.
- ㉗ Touch the desired number to enter the repeater frequency.
- Touch [CE] to delete the selected number.
 - Touch [←] to move the cursor backwards, or touch [→] to move the cursor forwards.
 - Touch the frequency entry field for 1 second to open the window, and then touch "Frequency Clear" to clear the frequency.

㉘ After entering, touch [ENT].

- ㉙ Touch [▼].

10. Selecting the duplex direction

- When '2. Selecting the communication type' is set to "DV Simplex" or "FM Simplex," this item does not appear.
- "DUP-" is automatically set when the access repeater frequency is entered in '9. Entering the access repeater frequency.'
- If necessary, you can change the duplex direction.

- ㉚ Touch "DUP."
- ㉛ Touch a desired duplex direction.
- OFF: Turn the duplex function OFF.
 - DUP-: The transmit frequency shifts down from the receive frequency by the offset amount.
 - DUP+: The transmit frequency shifts up from the receive frequency by the offset amount.

11. Entering the frequency offset

- When '2. Selecting the communication type' is set to "DV Simplex" or "FM Simplex," this item does not appear.
- The offset value* is automatically set when the access repeater frequency is programmed in '9. Entering the access repeater frequency.'
- *The default value differs, depending on the transceiver version.
- If necessary, you can change the frequency offset.

- ㉜ Touch "OFFSET FREQ."
- Enters the frequency offset edit mode.
- ㉝ Touch the desired number to enter the frequency offset.
- Touch [CE] to delete the selected number.
 - Touch [←] to move the cursor backwards, or touch [→] to move the cursor forwards.
 - Touch the frequency entry field for 1 second to open the window, and then touch "Frequency Clear" to clear the frequency.
- ㉞ After entering, touch [ENT].

12. Setting the FM mode

- When '2. Selecting the communication type' is set to "DV Repeater" or "DV Simplex," this item does not appear.

- ㉟ Touch "MODE."
- Enters the operating mode setting mode.
- ㊱ Touch "FM" or "FM-N."

☞ Continued on the next page.

Entering new information into the Repeater List

◇ Entering new information into the repeater list (Continued)

13. Setting the tone

When '2. Selecting the communication type' is set to "DV Repeater" or "DV Simplex," this item does not appear.

- ③⑧ Touch "TONE."
 - Enters the tone setting mode.
- ③⑨ Touch "TONE."

14. Selecting the repeater tone

When '2. Selecting the communication type' is set to "DV Repeater" or "DV Simplex," this item does not appear.
 This setting is required when '13. Setting the tone' is set to "TONE."

- ④① Touch "Repeater Tone."
 - Enters the repeater tone setting mode.
- ④② Touch [+] or [-] to select the repeater tone.
- ④③ Touch [↵].

15. Selecting the position data accuracy level

When the Near Repeater Search function is not used, or the distance between your position and a repeater is not displayed, select "OFF," and go to '18. Setting the UTC offset.'

- ④④ Touch "POSITION."
- ④⑤ Touch the position data accuracy level.
 - None: Select when the repeater has no position data.
 - Approximate: Select when the programmed position data is approximate.
 - Exact: Select when the programmed position data is exactly correct.

16. Entering the latitude

This item appears only when '15. Selecting the position data accuracy level' is set to "Approximate" or "Exact."

- ④⑥ Touch "LATITUDE."
 - Enters the latitude data edit mode.
- ④⑦ Touch the desired number to enter the latitude.
 - Touch [CE] to delete the selected number.
 - Touch [←] to move the cursor backwards, or touch [→] to move the cursor forwards.
 - Touch [N/S] to toggle between N (North latitude) and S (South latitude).
- ④⑧ After entering, touch [ENT].
- ④⑨ Touch [▼].

17. Entering the longitude

This item appears only when '15. Selecting the position data accuracy level' is set to "Approximate" or "Exact."

- ④⑩ Touch "LONGITUDE."
 - Enters the longitude data edit mode.
- ④⑪ Touch the desired number to enter the longitude.
 - Touch [CE] to delete the selected number.
 - Touch [←] to move the cursor backwards, or touch [→] to move the cursor forwards.
 - Touch [E/W] to toggle between E (East longitude) and W (West longitude).
- ④⑫ After entering, touch [ENT].

18. Setting the UTC offset

UTC (Universal Time Coordinated) offset is the time difference between UTC and repeater local time. This is a useful function to know the local time of the destination repeater before you make a call. (p. 12-62)

- ④⑬ Touch "UTC OFFSET."
 - Enters the UTC offset edit mode.
- ④⑭ Touch [+] or [-] one or more times to set the time difference between UTC and the local time.
 - If desired, touch the UTC offset entry field for 1 second to open the window, and then touch "Clear" to clear the UTC offset.
- ④⑮ After entering, touch [↵].

19. Saving the repeater list

- ④⑯ Touch "<<Add Write>>."
- ④⑰ Touch [YES].
 - The entered contents are saved to the repeater list, and the display returns to the RPT LIST screen.

To cancel the entered data:
 Touch [↵] to display "Cancel edit?" window.
 Touch [YES] to cancel entry and return to the "RPT LIST" screen.

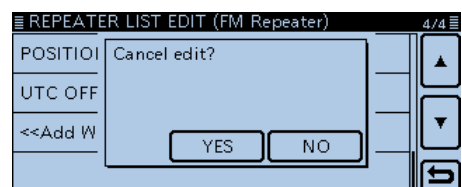

Editing a repeater list

This function edits a repeater's data. This is useful when already-entered data is incorrect, has changed, or some data needs to be added to the list.

- ① Touch [MENU].
- ② Touch "Repeater List."
(DV Memory > **Repeater List**)
 - The repeater groups are displayed.
- ③ Touch the repeater group for 1 second where the repeater you want to edit is listed.

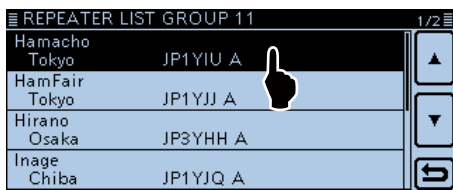

- ④ Touch "Edit."

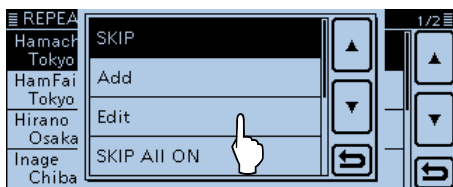

- ⑤ Edit the desired item.
 - See pages 7-22 to 7-24 for entry details.
- ⑥ After entering, touch "<<Overwrite>>."

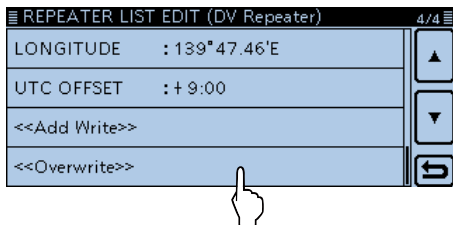

- ⑦ Touch "YES."
 - The edited contents are stored to the repeater list, and the display returns to the "RPT LIST" screen.

Deleting a repeater list

The programmed repeater contents can be deleted from the repeater list.

- ① Touch [MENU].
- ② Touch "Repeater List."
(DV Memory > **Repeater List**)
 - The repeater groups are displayed.
- ③ Touch the repeater group where the repeater you want to delete is listed, for 1 second.
- ④ Touch the repeater to be deleted, for 1 second.

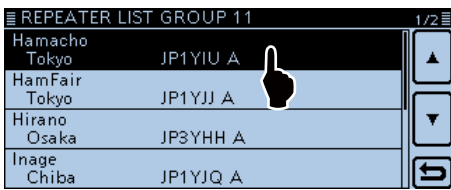

- ⑤ Touch "Delete."

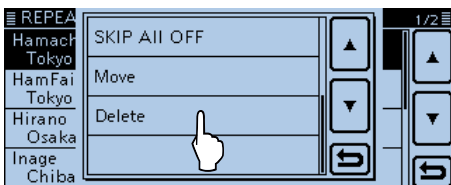

- ⑥ Touch [YES].
 - The programmed repeater contents are deleted from the repeater list, and the display returns to the "RPT LIST" screen.

Rearranging the display order of the repeater

You can move the programmed repeaters to rearrange their display order in the selected repeater group. The programmed repeater cannot be moved out of their assigned repeater group.

- ① Touch [MENU].
- ② Touch "Repeater List."
(DV Memory > **Repeater List**)
 - The repeater groups are displayed.
- ③ Touch the repeater group where the repeater you want to move is listed, for 1 second
- ④ Touch the repeater to be moved, for 1 second.

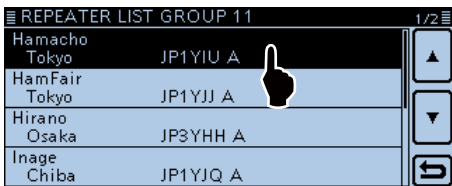

- ⑤ Touch "Move."
• "DESTINATION" blinks at the top left of the screen.

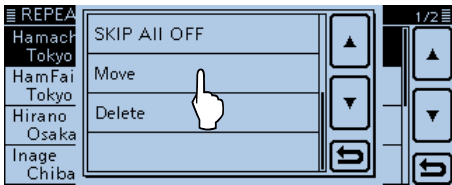

- ⑥ Touch the location to insert the repeater you want to move.
 - The selected repeater is inserted above the destination repeater name.
 - When "<<Move End>>" is selected, the selected repeater is moved to the bottom of the repeater group.

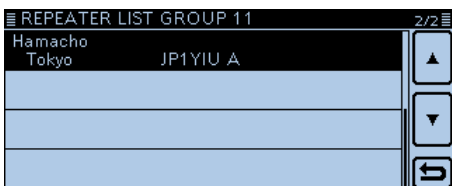
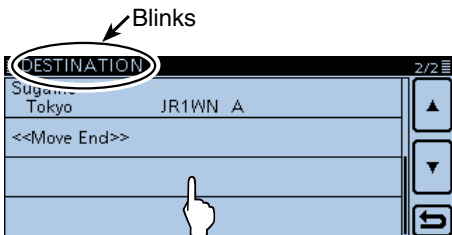

The selected repeater is moved to the bottom of the list

Adding the Repeater information using the RX History

This section describes how to add new repeater information to the repeater list using the RX history.

- ① Touch [MENU].
- ② Touch "RX History."

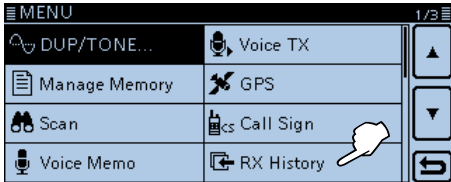

- ③ Touch [▲] or [▼] to display the desired repeater you want to add to the repeater list.
- ④ Touch [DETAIL]

• The RX history detail screen is displayed.

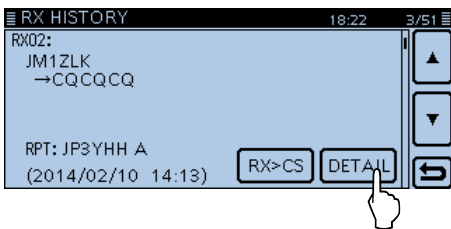

- ⑤ Touch [▼] to display "RXRPT1" and "RXRPT2."
- ⑥ Touch the screen for 1 second.

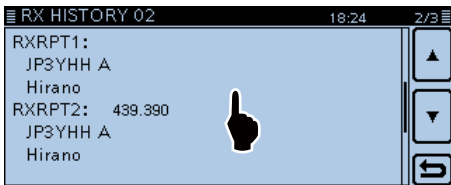

- ⑦ Touch "Add To RPT List".

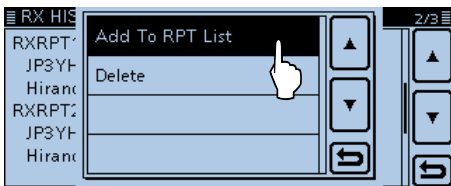

- ⑧ Touch the repeater call sign that you want to add to the repeater list.
 - Opens the "REPEATER LIST EDIT" screen. The selected repeater call sign is automatically programmed.
 - If necessary, edit the contents. (pp. 7-22 to 7-24)

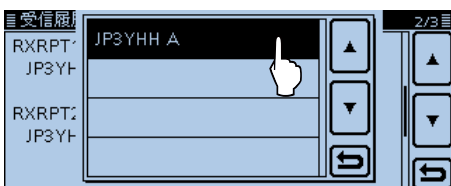

- ⑨ Touch "<<Add Write>>."
- ⑩ Touch "YES."
 - The programmed contents are added to the repeater list, and the display returns to the "RX HISTORY" screen.

How to switch the Name Display:
 When the call sign is displayed on the RX HISTORY screen, you can switch the display type to "Name Display."
 When the repeater name is not programmed in the repeater list, the display does not switch to the name display. It is convenient to find a repeater that is not included in the repeater list.

➔ When the "RX HISTORY" screen is displayed, touch [QUICK] to display the Quick menu. Then touch "Name Display."

The screenshot shows the 'RX HIS' screen with the 'Name Display' option highlighted in the Quick menu. A hand icon is shown touching the 'Name Display' option.

Skip setting for the DR scan

You can set repeaters as scan skip repeaters. The selected repeaters are then skipped for faster scanning. You can set the skip setting to all repeaters in the selected repeater group, or to individual repeaters.

When a repeater is specified as a skip repeater, its "USE (FROM)" setting is automatically set to "NO." In this case, the repeater cannot be selected in "FROM" (Access repeater).

◆ Individual skip setting

- ① Touch [MENU].
- ② Touch "Repeater List."
 - (DV Memory > Repeater List)
 - The repeater groups are displayed.
- ③ Touch the repeater group for 1 second where the repeater you set the skip setting is listed.
- ④ Touch the repeater for 1 second to be skipped.

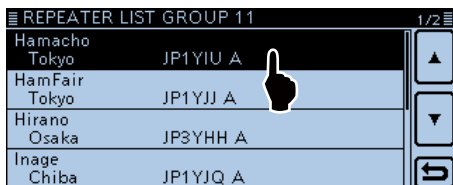

- ⑤ Touch "SKIP."
 - Displays "SKIP" on the selected repeater.
 - Touch the repeater for 1 second again to cancel the skip setting.
 - Touching "SKIP All ON" sets the skip setting to all repeaters in the group.

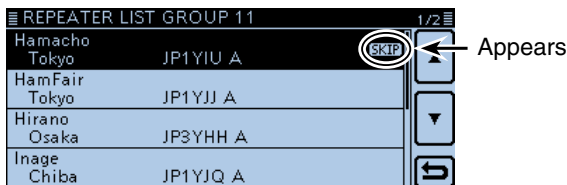
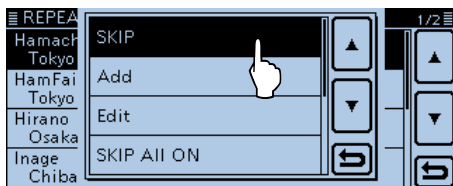

Group skip setting

Touch the repeater group for 1 second, and then touch "SKIP All ON" to skip the repeaters in the group during the DR scan.

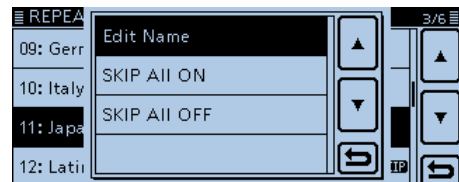

For your reference

When you select "Repeater List" in the "FROM SELECT" screen, you can set the skip setting as described to the left.

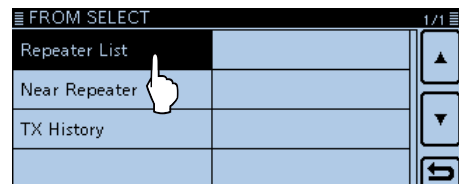

For your reference

When "FROM" is selected, touch [SKIP] in the F-2 menu for 1 second to set the skip setting. Touch [SKIP] again to clear the skip setting. Rotate [DIAL] to select another repeater, and you can set the skip setting.

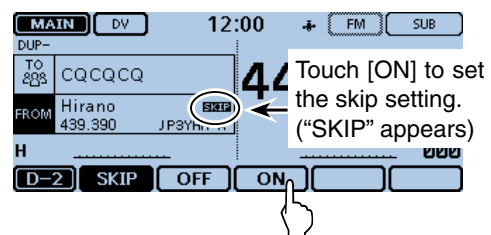
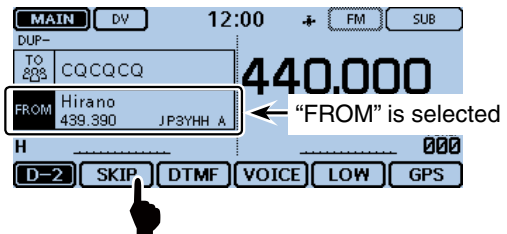

Repeater group name programming

- ① Touch [MENU].
- ② Touch "Repeater List."
(DV Memory > **Repeater List**)
 - If the item is not displayed, touch [▲] or [▼] one or more times to select another page.
 - The repeater groups are displayed.
- ③ Touch the repeater group where the repeater you edit the name is listed, for 1 second.

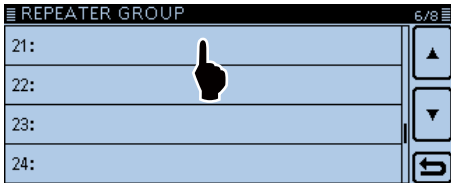

- ④ Touch "Edit Name."
 - Enters the group name edit mode.
 - Enter the group name of up to 8 characters, including spaces. See page 7-22 '3. Repeater name programming' for programming details.

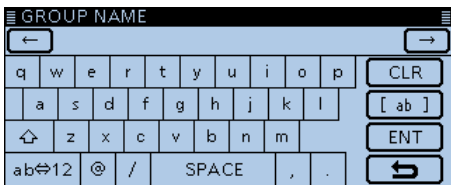
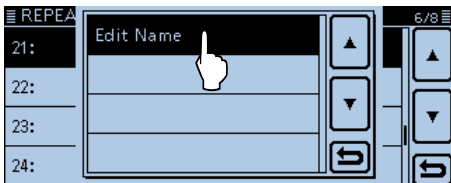

- ⑤ After entering, touch [ENT].

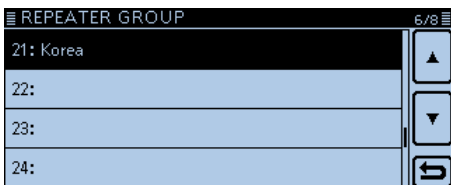

Example:

"Korea" is assigned to the repeater group 21.

Repeater detail screen

According to content, such as position data, UTC offset, and so on, the distance between your position and the repeater or the repeater time can be displayed on the REPEATER DETAIL screen.

The Detail screen can also be entered from the “FROM SELECT” screen.

Example: View the “Hamacho” repeater detail screen

- ① Touch [DR].
 - Displays the DR screen.
- ② Touch the “TO” field.
- ③ Touch “Gateway CQ.”
- ④ Touch “11: Japan.”
- ⑤ Touch “Hirano” for 1 second.

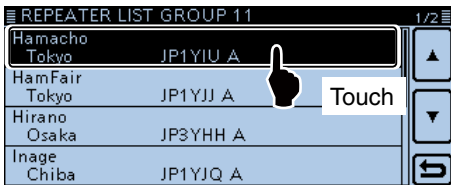

- ⑥ Touch “Detail.”
 - Displays the “REPEATER DETAIL” screen.

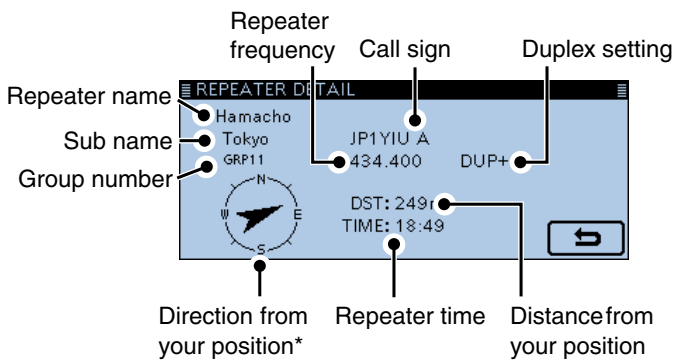
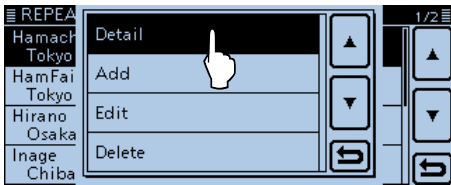

* When the position data accuracy level is set to “Approximate,” direction data is not displayed if the distance to the repeater is under 5 kilometers.

- ⑦ Touch [↶] to return to the repeater setting screen.

If you have no position data, the distance and direction from your position are not displayed.

To view the repeater details screen when the DR screen is displayed:

- ▶ When you set the repeater as shown below, touch [QUICK], and then, touch “Repeater Detail.”
 - Displays the “REPEATER DETAIL” screen.

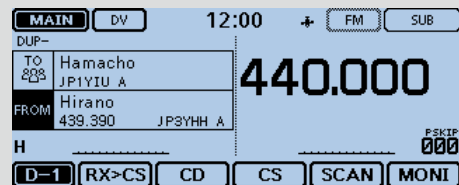

Repeater is set in “FROM”

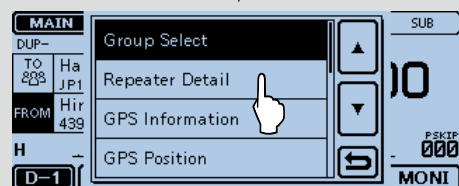

“Repeater Detail” is selected

Entering Your (destination) call sign

A Your (destination) call sign can be manually entered. When a Your (destination) call sign is set to "TO," you can make a call to a station, even if you don't know where the station is currently located. Up to 200 Your call signs can be entered.

Example: Program "TOM/JM1ZLK" to the Your Call Sign memory.

- ① Touch [MENU].
- ② Touch "Your Call Sign."
(DV Memory > **Your Call Sign**)
 - If the item is not displayed, touch [▲] or [▼] one or more times to select another page.
- ③ Touch the list for 1 second.

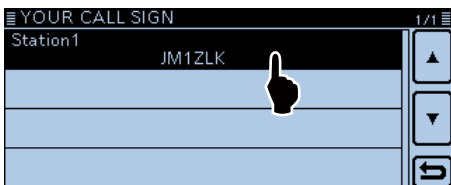

- ④ Touch "Add."
• Displays the "YOUR CALL SIGN EDIT" screen.

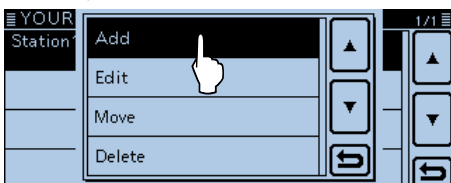

If you touch "Edit," you can edit the selected station information.

- ⑤ Touch "NAME."
• Enters the name edit mode.

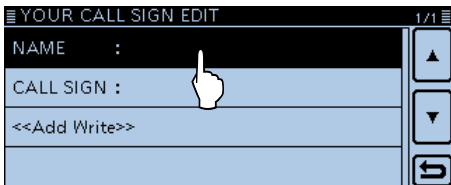

- ⑥ Touch the keypad.
 - Enters the desired character or symbol.
 - In the Alphabet entry mode, touch "↑" to enter an upper case letter once, or touch "↑↑" to continuously enter upper case letters. Touch "↕" to enter lower case letters.
 - Touch [[ab]] or [[12]], and then touch [ab], [12] or [(!#)] to select the desired entry mode.

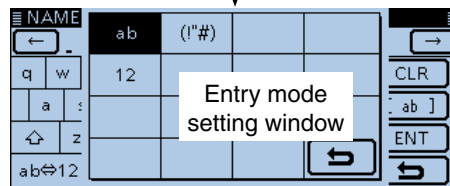
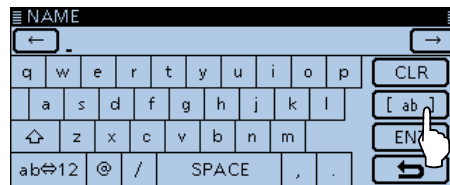

- Touch "ab↔12" to toggle between the Alphabet entry and Number entry modes.
- Touch "SPACE" to enter a space.
- Touch [CLR] to delete the selected character, symbol or number.
- Touch [QUICK], and then touch "Switch to Tenkey" to switch the keyboard type.

Selectable characters and symbols
A to Z, a to z, 0 to 9, !"#\$%&'()*+,-./:;<=>?@[\\]^_`{ }~(space)

- ⑦ Touch [←] to move the cursor backwards, or touch [→] to move the cursor forwards.
- ⑧ Repeat steps ⑦ and ⑧ to enter a name of up to 16 characters, including spaces.
(Example: First, S, then t, then a, then t, then i, then o, then n, then 2.)



- ⑨ After entering, touch [ENT].

☞ Continued on the next page

Entering Your (destination) call sign (Continued)

- ⑩ Touch "CALL SIGN."
- Enters Your call sign edit mode.

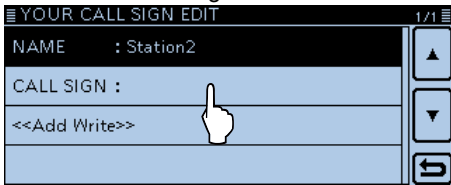

- ⑪ Touch the desired keypad to select the first digit.
- A to Z, 0 to 9, / and (Space) are selectable.
- Touch "ab↔12" to toggle between the Alphabet entry and Number entry modes.
- Touch [CLR] to delete the selected character, symbol or number.
- Touch "SPACE" to enter a space.

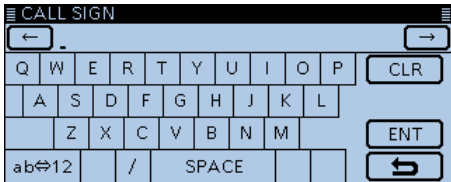

- ⑫ Touch [←] to move the cursor backwards, or touch [→] to move the cursor forwards.
- ⑬ Repeat steps ⑪ and ⑫ to enter Your call sign of up to 8 characters, including spaces.
- ⑭ After entering, touch [ENT].
- ⑮ Touch "<<Add Write>>."

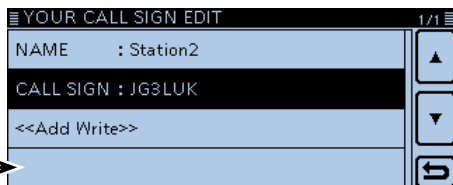

When you select "Edit" in step ④, "Overwrite" is displayed here.

- ⑯ Touch [YES].

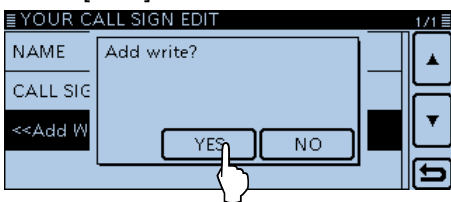

- ⑰ Touch [MENU].
- Closes the Menu screen.

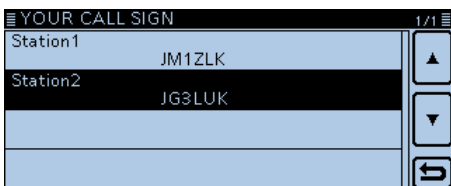

"Station2 JG3LUK" is entered into the Your Call Sign memory.

To cancel the entered data:
To cancel the entered data, push [↵] to display "Cancel edit?." Touch "YES" to cancel the entry and the display returns the "YOUR CALL SIGN" screen.

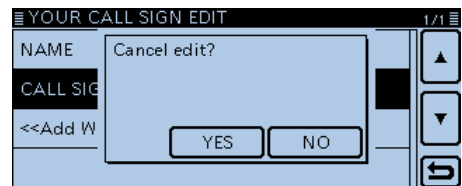

To edit the entered data:
To reprogram a Your (destination) call sign's data, touch "Edit" in step ①. This is useful when already-entered data is incorrect, has changed or some data needs to be added to the list.

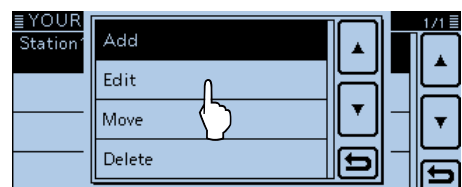

Deleting Your (destination) call sign

The Your (destination) call signs can be deleted from the Your Call Sign memory.

- ① Touch [MENU].
- ② Touch "Your Call Sign."
(DV Memory > **Your Call Sign**)
 - If the item is not displayed, touch [▲] or [▼] one or more times to select another page.
- ③ Touch the call sign you want to delete for 1 second.



- ④ Touch "Delete."

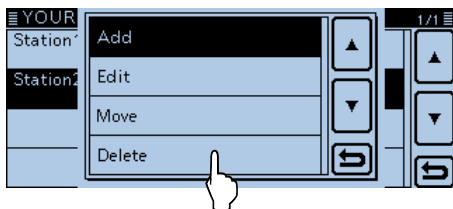

- ⑤ Touch "YES."
 - The programmed call sign contents are deleted from the Your call sign list, and the display returns to the YOUR CALL SIGN screen.

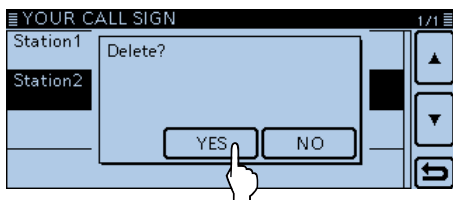

Rearranging the display order of Your (destination) call signs

You can move Your call signs to rearrange their display order.

It is easy to find stations that you often communicate with if the stations are moved to the top of the list.

- ① Touch [MENU].
- ② Touch "Your Call Sign."
(DV Memory > **Your Call Sign**)
 - If the item is not displayed, touch [▲] or [▼] one or more times to select another page.
- ③ Touch the call sign you want to move for 1 second.

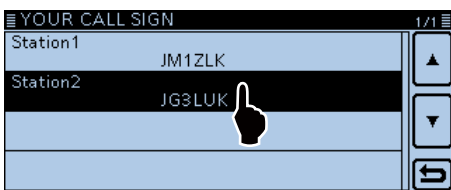

- ④ Touch "Move."
• "DESTINATION" blinks in the top left of the LCD.

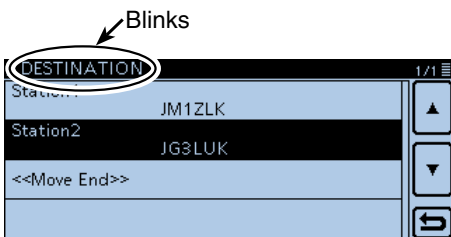
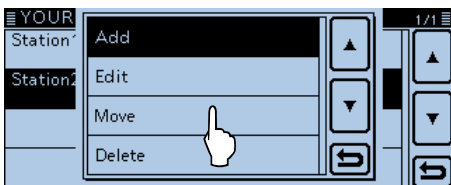

- ⑤ Touch the location to insert the call sign you want to move,.
 - The selected call sign is inserted to above the destination.
 - When "<<Move End>>" is selected, the selected call sign is moved to the bottom of the "YOUR CALL SIGN" list.

Your setting is correct?

If you make a local area call with a gateway setting still selected in "TO," the destination repeater will be busy while you transmit.

So the stations that use that repeater as their Access repeater cannot access it, as shown below.

BE SURE to set CQCQCQ in "TO" when you intend to make a local call, or after you finish a Gateway call.

Example: JM1ZLK wants to make a Local area call.

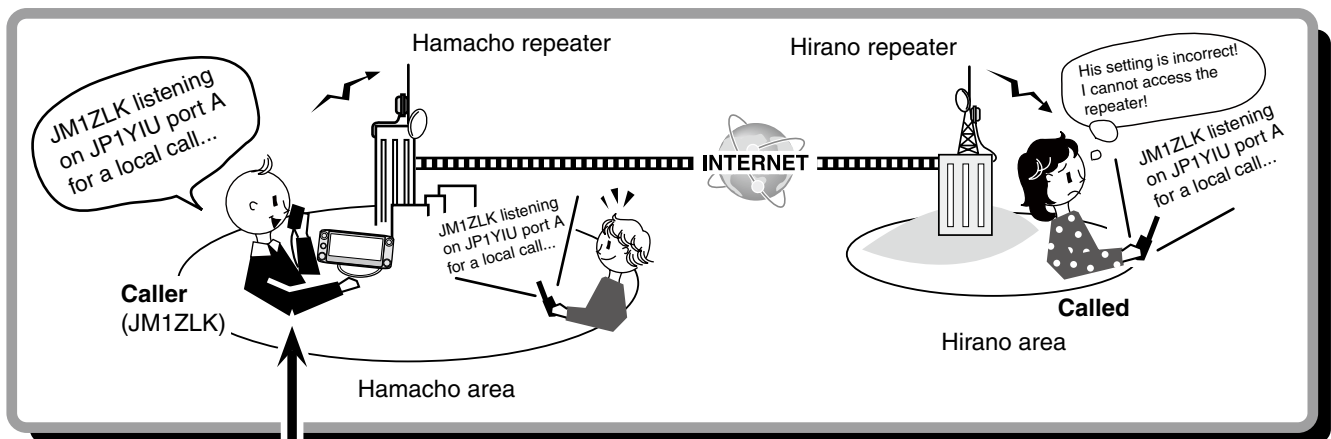

JM1ZLK's setting

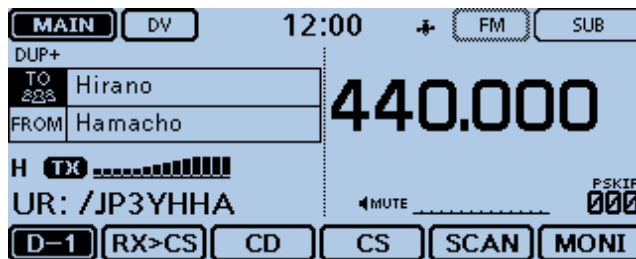

The destination ("TO") setting is incorrect.

NOTE: With this setting, the Local area call can be made, but the destination repeater, selected in "TO," is also busy while you transmit. So the station that uses the destination repeater as their Access repeater cannot access it.

Correct setting

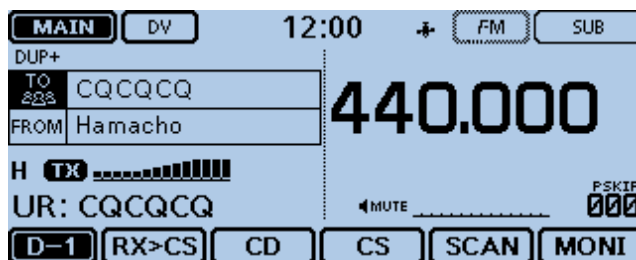

To make a Local area call, set the destination ("TO") to "CQCQCQ." See page 6-13 for details.

About the repeater list default values

You can check the repeater list default values using the CS-5100 CLONING SOFTWARE, if you download the ICF (Icom Cloning Format) file, including the default repeater list from the Icom website.

<http://www.icom.co.jp/world/support/download/firm/index.html>

When you open the downloaded ICF file with the CS-5100, the repeater list default values are displayed on the screen.

To reset the programmed repeater list to the default, write the ICF file to the transceiver using the CS-5100*1, or copy the ICF file to the SD card*2, and then write to the transceiver.

*1 See the CS-5100 instruction manual when using the CS-5100.

*2 See Section 9 when using the SD card.

◆ Opening the default repeater list

- ① Start the CS-5100.
 - See the CS-5100 instruction manual for how to install the software.
- ② Click [Open] to open the ICF file.
- ③ Click the [Repeater list] folder to show the default repeater list.

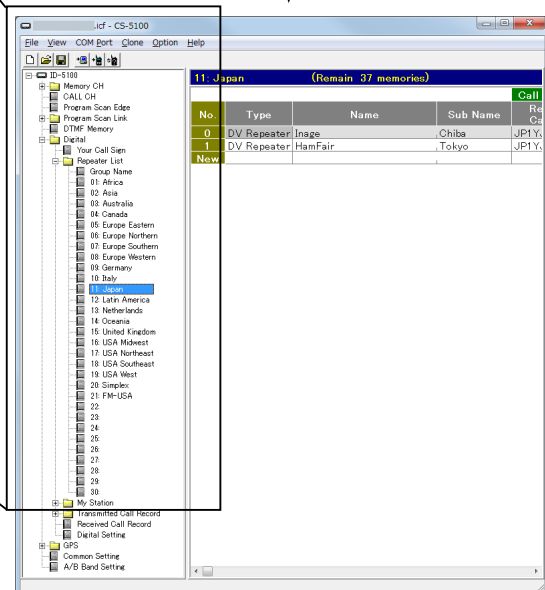
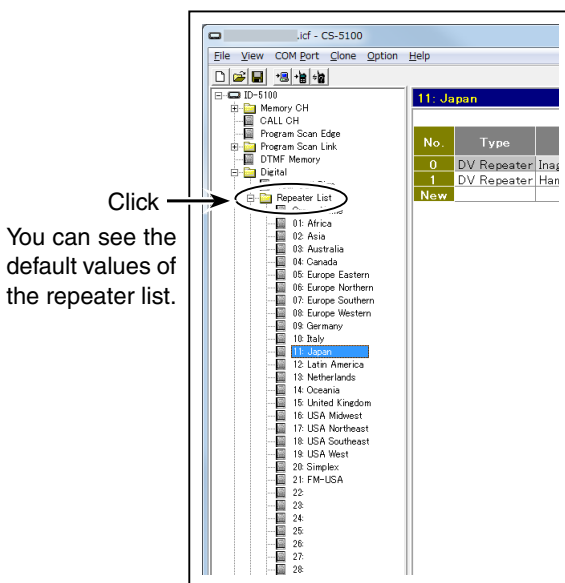
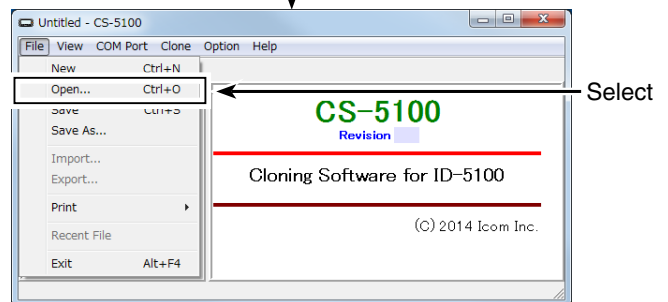

When the ICF file is opened on the CS-5100.

GPS operation.....	8-2
◇ GPS receive setting.....	8-2
When a received signal contains position data.....	8-3
Checking your GPS position	8-4
◇ Displaying Position Data.....	8-4
◇ Displayed items	8-6
◇ TX format: D-PRS Position (Mobile).....	8-7
◇ TX format: D-PRS Position (Base)	8-7
◇ TX format: D-PRS Object.....	8-8
◇ TX format: D-PRS Item	8-8
◇ TX format: D-PRS Weather.....	8-9
◇ TX mode: NMEA	8-9
◇ Setting the display type (MAIN/SUB)	8-10
◇ Changing the GPS memory or alarm.....	8-10
◇ About the Grid Locator	8-11
◇ Changing the Compass Direction.....	8-11
◇ Saving your own or a received position.....	8-12
Checking GPS information (Sky view screen).....	8-13
Transmitting GPS data (D-PRS and NMEA)	8-14
◇ Type of position data	8-14
◇ Setting the GPS TX mode	8-14
Transmitting D-PRS data	8-15
◇ D-PRS	8-15
◇ Operating D-PRS	8-15
◇ Displayed items	8-16
◇ Setting D-PRS Position (Mobile/Base).....	8-17
◇ Setting D-PRS Object/Item.....	8-19
◇ Setting D-PRS Weather.....	8-23
◇ Weather station transmission	8-25
◇ Confirming the weather data input	8-25
◇ Application setting	8-25
◇ About the weather data content	8-25
◇ Displaying your position using a mapping program.....	8-26
Transmitting NMEA data	8-27
◇ Setting the GPS data sentence.....	8-27
◇ Entering the GPS message.....	8-28
Adding or editing GPS memory	8-29
◇ GPS memory.....	8-29
◇ Add a GPS memory	8-29
◇ Entering the GPS group name	8-33
◇ Clearing GPS data	8-34
◇ Rearranging the display order of the GPS data	8-35
◇ Setting the GPS alarm	8-36
GPS Logger function.....	8-38
◇ GPS Logger operating outline	8-38
◇ GPS Logger operation.....	8-38
◇ Setting the GPS record interval.....	8-38
◇ Viewing the log data on a PC Map.....	8-39
GPS Auto transmission for only Simplex.....	8-41
◇ Setting the GPS automatic transmission.....	8-41

GPS operation

The transceiver has a built-in GPS receiver. You can check your current position, and transmit GPS data in the DV mode.

◇ GPS receive setting

Check whether or not the GPS receiver is receiving your position.

The GPS icon blinks when searching for satellites.



The GPS icon stops blinking when the minimum number of required satellites are found.



- It may take only a few seconds to receive. But depending on the environment, it may take a few minutes. If you have difficulties receiving, we recommend that you try a different location.
- When “GPS Select” item is set to “Manual,” the icon does not appear.
(GPS > GPS Set > **GPS Select**)

When a received signal contains position data

When a received signal contains position data, the caller's position is displayed on the RX position window. See page 8-4 for details.

Example: When the signal from JM1ZLK contains position data.



When you receive the signal, the RX position information is displayed in the RX position window.



After a few seconds, the pop-up window disappears.

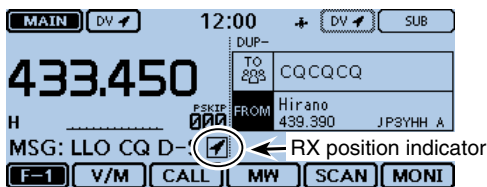

When the received signal contains position data, the RX position indicator is displayed on the right side of the message.

If you touch the RX position indicator, the RX position window appears again.

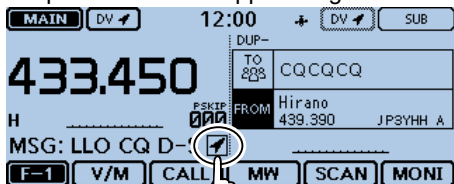

▨ You can turn OFF the RX position window to keep it from appearing. (p. 12-58)
 (Display > RX Position Display)

▨ You can turn OFF the RX position indicator to keep it from appearing. (p. 12-57)
 (Display > RX Position Indicator)

Checking your GPS position

You can check your current location. This section is described using received data.

◇ Displaying Position Data

① Touch the GPS icon.



② Touch [GPS Position].

- Opens the "GPS POSITION" screen.

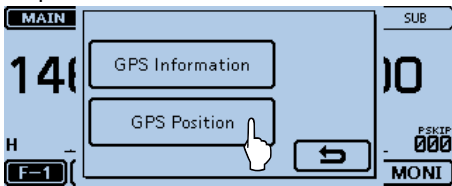

③ Touch [▲] or [▼] one or more times.

- Selects the page.
- My (MY) screen, the received (RX) screen, the GPS memory (MEM) channel screen, and the GPS alarm (ALM) channel screen are selectable.
- MY: Displays your position in latitude and longitude, grid locator, altitude, speed*, time, compass heading* and direction*.
- * Does not appear when "GPS Select" is set to "Manual." (p. 12-20)
(GPS > GPS Set > GPS Select)
- RX: Displays the caller station's position in latitude and longitude, grid locator, altitude, distance/direction from your position, SSID, course, speed, TX power level, height, antenna gain, antenna direction, temperature, rainfall, wind direction, wind speed, barometric pressure, humidity, Time stamp, D-PRS symbol, and call sign.
- Depending on the received signal, some data may not be displayed. (p. 8-6)
- MEM: Displays the GPS memory channel's position in latitude and longitude, grid locator, and distance/direction from your position.
- ALM: Displays the GPS alarm memory channel position in latitude and longitude, grid locator, and distance/direction from your position.

④ Touch [↵].

- Closes the "GPS POSITION" screen.

For your reference:

If you transmit when the "GPS POSITION" screen is displayed, the screen will be cancelled. But while transmitting, you can display the "GPS POSITION" screen again by touching the GPS icon to check the position data while transmitting.

NOTE:

Latitude, longitude, and altitude data may differ, depending on your GPS.

[About the GPS Position screen]

<MY>

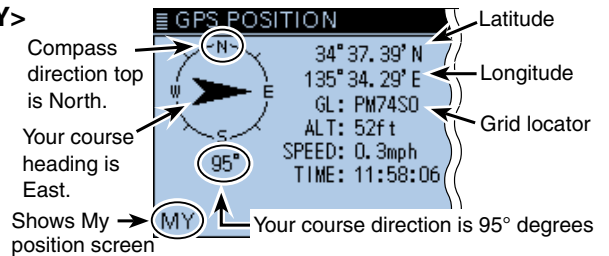

<RX>

When the caller's TX format is D-PRS Position (Mobie station)

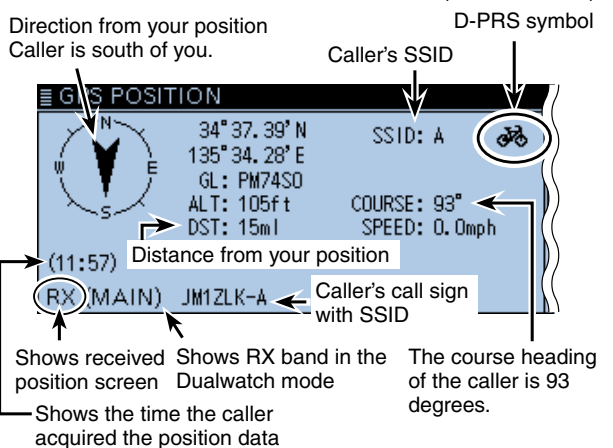

<MEM>

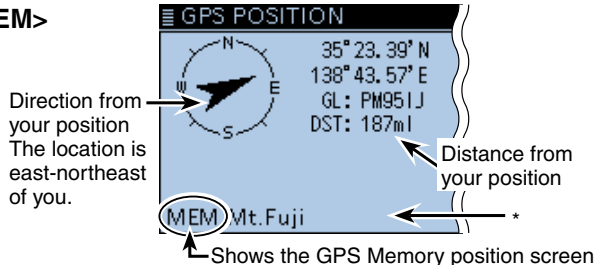

<ALM>

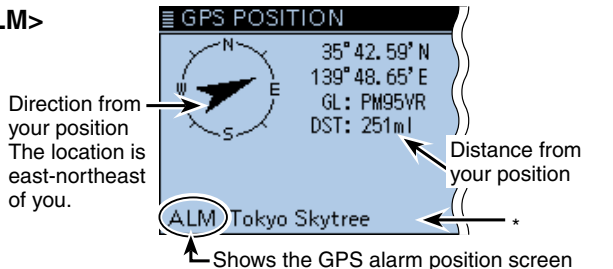

*When a name is not assigned to the memory channel, date and time are displayed instead of the name.

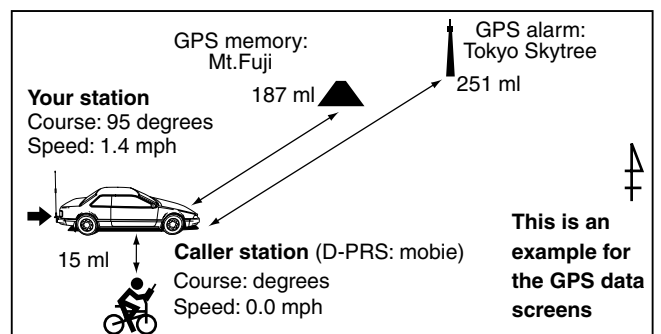

Checking your GPS position (Continued)

GPS position data has two transmit modes: D-PRS and NMEA. Moreover, with the D-PRS mode data, five type of position format, Position (Mobile station/Base station), Object, Item and Weather, are selectable.

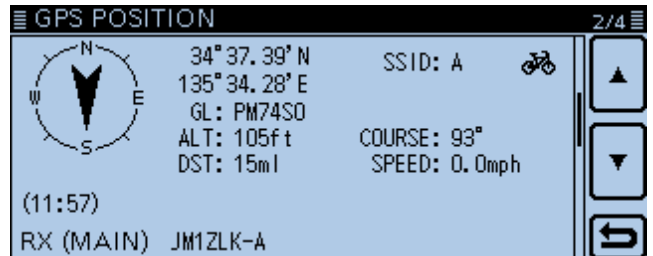
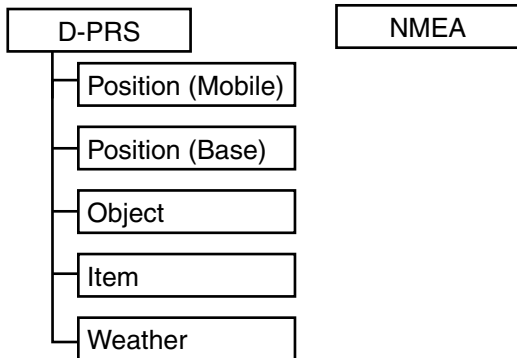

Example: When the caller's TX format is D-PRS Position (Mobie)

- **D-PRS:** D-PRS is a function which simultaneously sends position data received from the internal or external GPS receiver, using the slow speed data packet space, along with voice.
- **Mobile:** A station operating while moving.
- **Base:** A station operating at home or in any building.
- **Object:** A station transmitting specific position data.
An event notice, earthquake information, satellite track information, and so on, can be transmitted.
You can add a time stamp data to the object signal.
- **Item:** A station transmitting a specific position data, not containing a time data.
Position information such as a traffic accident, lighthouse, antenna or DV access point location, and so on, can be transmitted.
You cannot add a time stamp to the item signal.
- **Weather:** A station transmitting a weather information received from the weather device.
- **NMEA:** A station transmitting position data (NMEA0183) received from the internal or an external GPS receiver.

For users who have a D-STAR transceiver model prior to the ID-5100A/E:
 The GPS TX mode, "GPS (DV-G)" and "GPS-A (DV-A)," are now called "NMEA" and "D-PRS."
 • GPS (DV-G) → NMEA
 • GPS-A (DV-A) → D-PRS

Checking your GPS position (Continued)

◇ Displayed items

Depending on the caller's transmit mode or transmit format, the displayed items differ.

	NMEA	D-PRS								
		Position		Object			Item			Weather
		Mobile	Base	Data extension: OFF	Data extension: Course/Speed	Data extension: Power/Height/Gain/Directivity	Data extension: OFF	Data extension: Course/Speed	Data extension: Power/Height/Gain/Directivity	
Compass	✓	✓	✓	✓	✓	✓	✓	✓	✓	✓
Latitude	✓	✓	✓	✓	✓	✓	✓	✓	✓	✓
Longitude	✓	✓	✓	✓	✓	✓	✓	✓	✓	✓
Grid locator	✓	✓	✓	✓	✓	✓	✓	✓	✓	✓
Altitude	✓	✓	✓	✓	✓	✓	✓	✓	✓	
Distance	✓	✓	✓	✓	✓	✓	✓	✓	✓	✓
Direction	✓	✓			✓			✓		
Speed	✓	✓			✓			✓		
Power			✓			✓			✓	
Height			✓			✓			✓	
Gain			✓			✓			✓	
Directivity			✓			✓			✓	
Temperature										✓
Rainfall										✓
Wind direction										✓
Wind speed										✓
Barometric pressure										✓
Humidity										✓
Symbol		✓	✓	✓	✓	✓	✓	✓	✓	✓
SSID		✓	✓	✓	✓	✓	✓	✓	✓	✓
Time stamp	✓	✓	✓	✓	✓	✓				✓
Call sign	✓	✓	✓	✓	✓	✓	✓	✓	✓	✓

✓: Displayed

Checking your GPS position (Continued)

◇ TX format: D-PRS Position (Mobile)

The following items are displayed when the caller's TX format is D-PRS Position (Mobile).

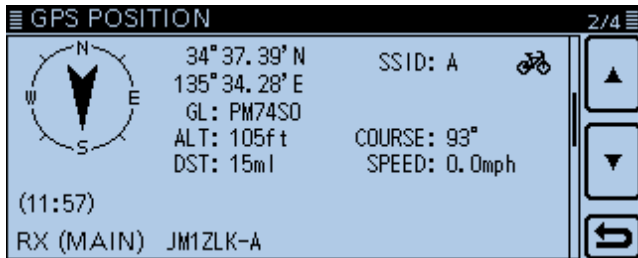

Compass	Displays the caller's direction from your position
Latitude	Displays the caller's latitude
Longitude	Displays the caller's longitude
GL	Displays the grid locator based on the latitude and longitude of the caller's position.
ALT	Displays the caller's altitude
DST	Displays the caller's distance from your position
COURSE	Displays the caller's direction over ground
SPEED	Displays the caller's speed
Symbol	Displays the caller's D-PRS symbol
SSID	Displays the caller's SSID
GPS Time Stamp	Displays the time that the caller acquired the position data.
Call sign	Displays the caller's call sign (with SSID)

◇ TX format: D-PRS Position (Base)

The following items are displayed when the caller's TX format is D-PRS Position (Base).

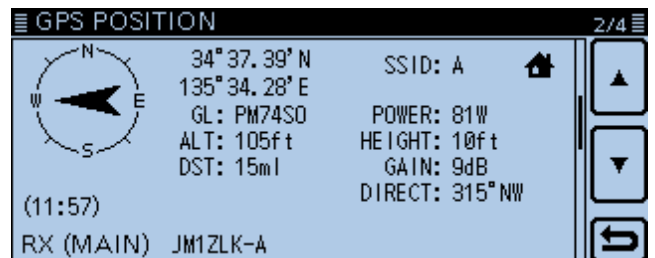

Compass	Displays the caller's direction from your position
Latitude	Displays the caller's latitude
Longitude	Displays the caller's longitude
GL	Displays the grid locator based on the latitude and longitude of the caller's position.
ALT	Displays the caller's altitude
DST	Displays the caller's distance from your position
POWER	Displays the caller's TX power level
HEIGHT	Displays the height of caller's antenna
GAIN	Displays the gain of caller's antenna
DIRECT	Displays the direction the caller's antenna was pointing
Symbol	Displays the caller's D-PRS symbol
SSID	Displays the caller's SSID
GPS Time Stamp	Displays the time that the caller acquired the position data.
Call sign	Displays the caller's call sign (with SSID)

Checking your GPS position (Continued)

◇ TX format: D-PRS Object

The following items are displayed when the caller's TX format is D-PRS Object.

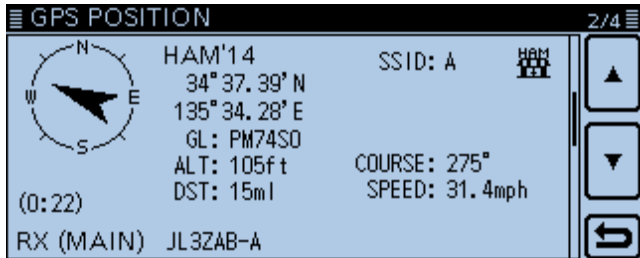

◇ TX format: D-PRS Item

The following items are displayed when the caller's TX format is D-PRS Item.

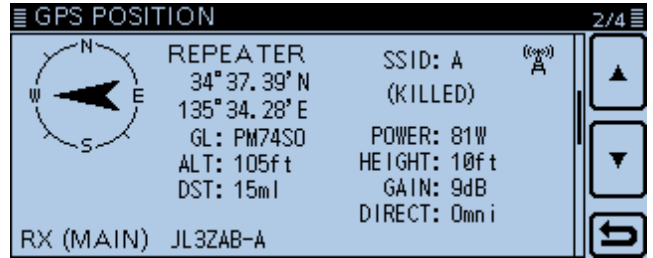

Compass	Displays the Object station's direction from your position
Latitude	Displays the Object station's latitude
Longitude	Displays the Object station's longitude
GL	Displays the grid locator based on the latitude and longitude of the Object station's position.
ALT	Displays the Object station's altitude
DST	Displays the Object station's distance from your position
COURSE	Displays the Object station's direction over ground
SPEED	Displays the Object station's speed
POWER	Displays the Object station's TX power level
HEIGHT	Displays the height of Object station's antenna
GAIN	Displays the gain of Object station's antenna
DIRECT	Displays the direction that the Object station's antenna was pointing
Symbol	Displays the Object station's D-PRS symbol
SSID	Displays the caller's SSID
GPS Time Stamp	Displays the time that the caller sent the Object station's data.
Call sign	Displays the caller's call sign (with SSID)

When the Object station is disabled, "KILLED" appears.

Compass	Displays the Item station's direction from your position
Latitude	Displays the Item station's latitude
Longitude	Displays the Item station's longitude
GL	Displays the grid locator based on the latitude and longitude of the Item station's position.
ALT	Displays the Item station's altitude
DST	Displays the Item station's distance from your position
COURSE	Displays the Item station's direction over ground
SPEED	Displays the Item station's speed
POWER	Displays the Item station's TX power level
HEIGHT	Displays the height of Item station's antenna
GAIN	Displays the gain of Item station's antenna
DIRECT	Displays the direction that the Item station's antenna was pointing
Symbol	Displays the Item station's D-PRS symbol
SSID	Displays the caller's SSID
Call sign	Displays the caller's call sign (with SSID)

When the Item station is disabled, "KILLED" appears.

Checking your GPS position (Continued)

◇ TX format: D-PRS Weather

The following items are displayed when the caller's TX format is D-PRS Weather.

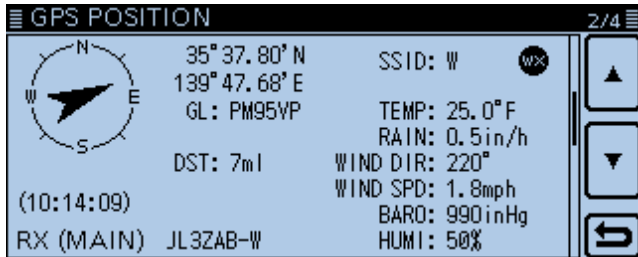

Compass	Displays the caller's direction from your position
Latitude	Displays the caller's latitude
Longitude	Displays the caller's longitude
GL	Displays the grid locator based on the latitude and longitude of the caller station's position
DST	Displays the caller's distance from your position
TEMP	Displays the temperature of the caller station's area
RAIN	Displays the rainfall of the caller station's area
WIND DIR	Displays the wind direction of the caller station's area
WIND SPD	Displays the wind speed of the caller station's area
BARO	Displays the barometric pressure of the caller station's area
HUMI	Displays the humidity of the caller station's area
Symbol	Displays the caller station's D-PRS symbol
SSID	Displays the caller's SSID
GPS Time Stamp	Displays the time that the caller acquired the weather data.
Call sign	Displays the caller's call sign (with SSID)

◇ TX mode: NMEA

The following items are displayed when the caller's TX mode is NMEA.

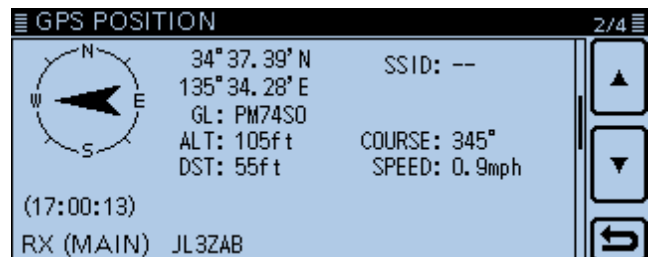

Compass*	Displays the caller's direction from your position.
Latitude	Displays the caller's latitude
Longitude	Displays the caller's longitude
GL	Displays the grid locator based on the latitude and longitude of the caller's position.
ALT	Displays the caller's altitude
DST	Displays the caller's distance from your position
COURSE	Displays the caller's direction over ground
SPEED	Displays the caller's speed
GPS Time Stamp	Displays the time that the caller acquired the position data.
Call sign	Displays the caller's call sign

Checking your GPS position (Continued)

◇ Setting the display type (MAIN/SUB)

You can select the display type for the “RX” of the “GPS POSITION” screen.

- ① When the “RX” screen is displayed, touch [QUICK].
- ② Touch “Display Select(MAIN/SUB).”

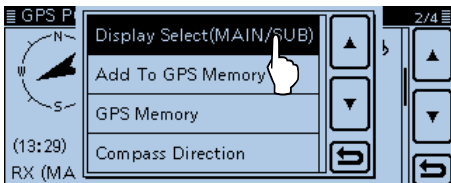

- ③ Touch the desired option.

- Latest (MAIN/SUB): The last received station’s position information is displayed.
- MAIN: The position information of the station received on the MAIN band is displayed.
- SUB: The position information of the station received on the SUB band is displayed.

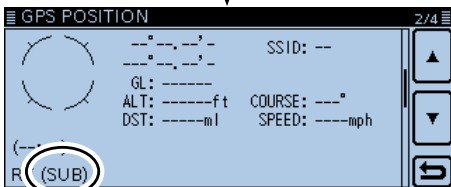
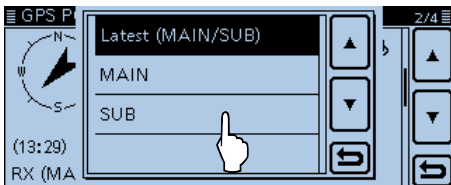

When you select “SUB” in step ③, “(SUB)” appears next to “RX.”

◇ Changing the GPS memory or alarm

You can change the GPS memory or GPS alarm in the “GPS POSITION” screen.

- ① When the “MEM” or “ALM” screen is displayed, touch [QUICK].
- ② When the “MEM” screen is displayed in step ①, touch “GPS Memory Select,” and when the “ALM” screen is displayed in step ①, touch “Alarm Select.”
- ③ Touch [▲] or [▼] one or more times to select the desired GPS memory or GPS alarm to display on the “GPS POSITION” screen.

“MEM” screen

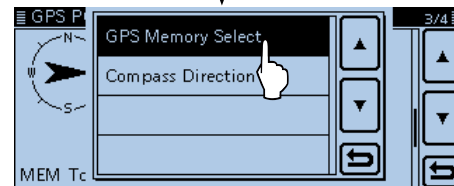
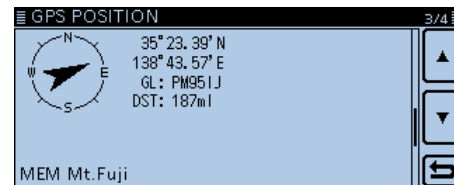

“ALM” screen

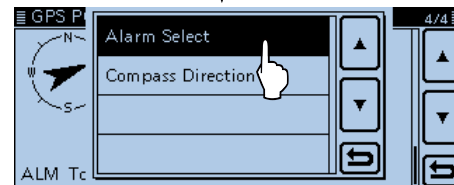
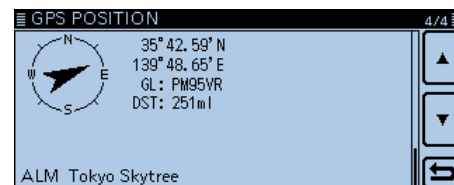

Checking your GPS position (Continued)

◇ About the Grid Locator

Grid Locator (GL) is a location compressed into a 6 character code, calculated by the longitude and the latitude.

The locator is simply calculated by dividing the earth surface into squares.

It is used to find the location of a radio station.

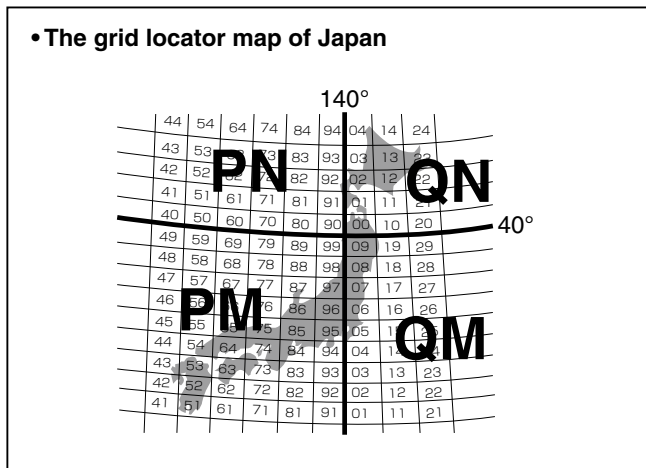
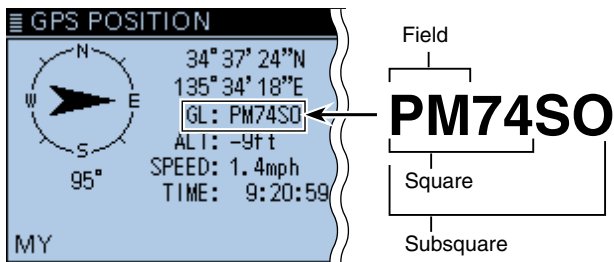

◇ Changing the Compass Direction

You can change the compass direction between Heading Up, North Up and South Up.

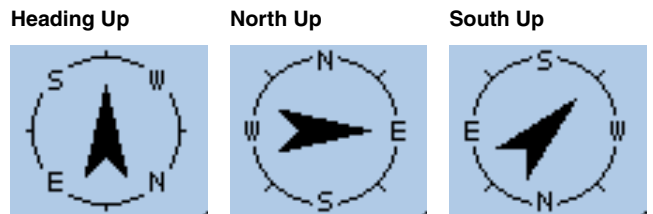

- ① When the “GPS POSITION” screen is displayed, touch [QUICK].

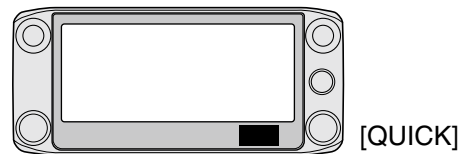

- ② Touch “Compass Direction.”

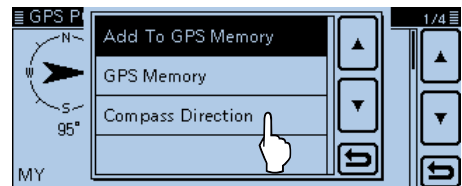

- ③ Touch to select the compass direction.
 - Heading Up: The compass always pointed to your heading course direction.
 - North Up: The top is always north.
 - South Up: The top is always south.

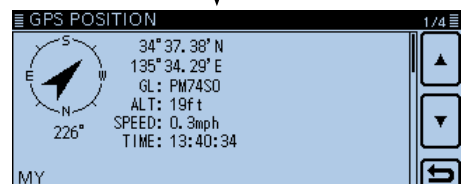
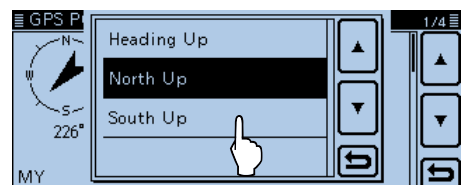

When you select “South Up.”

Checking your GPS position (Continued)

◇ Saving your own or a received position

With this function, you can save the position information of your station from wherever you are, and also the position information of the station you received it from.

The GPS Memory is capable of storing a total of 200 channels, assignable to one of 27 banks, A to Z and (No Group).

① Touch the GPS icon.

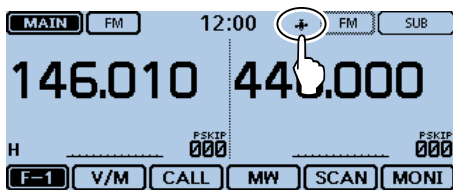

② Touch [GPS Position].

- Opens the “GPS POSITION” screen.

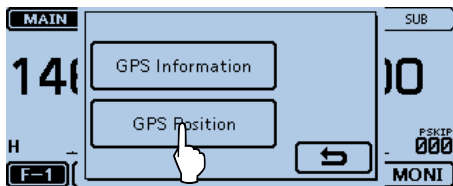

③ Touch [▲] or [▼] one or more times.

- Selects the screen that you want to save between “MY” and “RX.”
- To save the position information of your station, select “MY.”
- To save the position information of the station you received from, select “RX.”

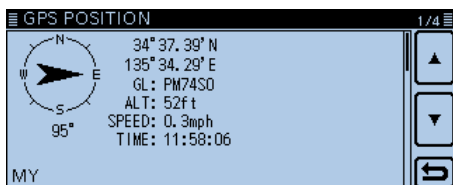

④ Touch [QUICK].

⑤ Touch “Add To GPS Memory.”

- Displays “GPS MEMORY EDIT” screen.
- See page 8-29 to 8-32 for entering details.

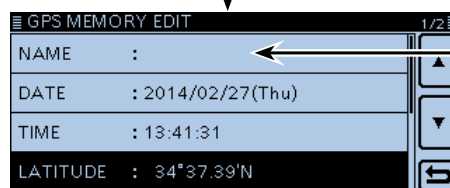
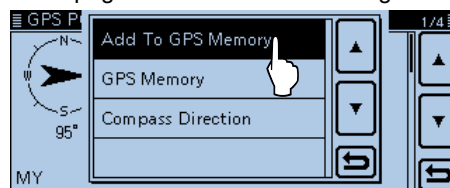

Touch a Memory contents title to edit. (Example: Name)

⑥ Touch “<<Add Write>>.”

- Opens “Add write?” window.
- The latitude and longitude data on the “GPS POSITION” screen is automatically entered.
- You can select the destination group to be stored.

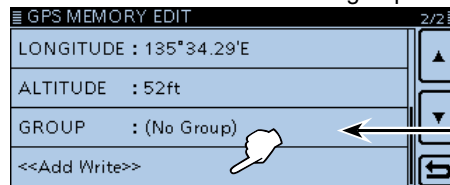

Select a destination group to save.

⑦ Touch [YES].

- Saves the data in the GPS memory and returns to the “GPS POSITION” screen.

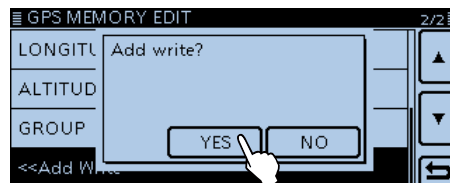

⑧ Touch [↵].

- Closes the “GPS POSITION” screen.

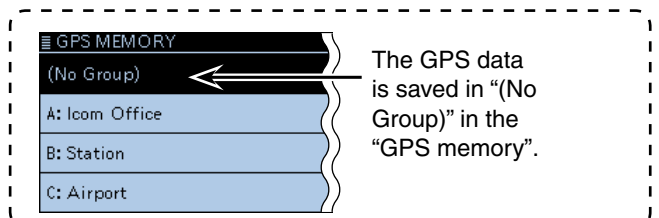

The GPS data is saved in “(No Group)” in the “GPS memory”.

Checking GPS information (Sky view screen)

This screen is used to view GPS satellite information when the GPS indicator does not stop blinking for a long time.

GPS Information displays the quantity, signal power and position of the GPS satellites.

The sky view screen shows the position of GPS satellites. The screen also shows the direction, elevation angle, satellite numbers and their receiving signal strength status.

① Touch the GPS icon.

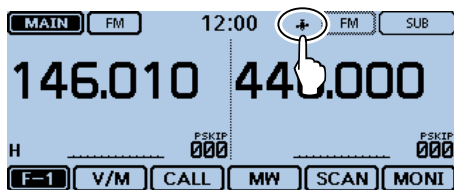

② Touch [GPS Information].

• Opens the "GPS INFORMATION" screen.

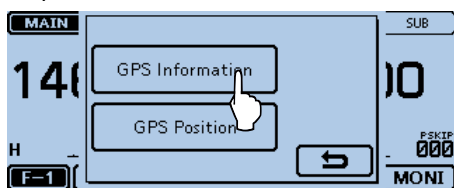

Meaning of each icon

- (○): Untracking satellite.
- (01): Tracking satellite with a weak signal shown by the satellite number.
- (01): Tracking satellite with a strong signal shown by the satellite number.
- (SAT): The quantity of tracking satellites.
- Altitude: The altitude of your station.
The altitude is only displayed when more than 4 satellites are tracked. When less than 3 satellites are tracked, "-----ft" is displayed.
- Longitude/Latitude: Longitude and Latitude of your station.
- Signal strength graph: Signal strength of the satellites
 - : Tracking satellite with a strong signal
 - ▒: Tracking satellite with a weak signal
 - : Untracking satellite

③ Touch [↵].

• Closes the "GPS INFORMATION" screen.

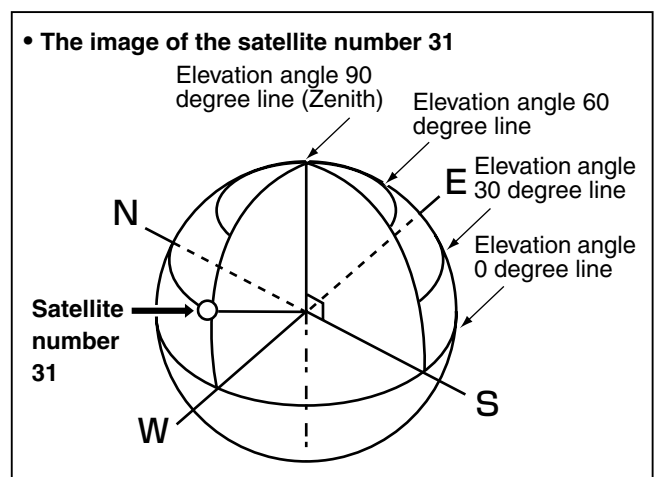
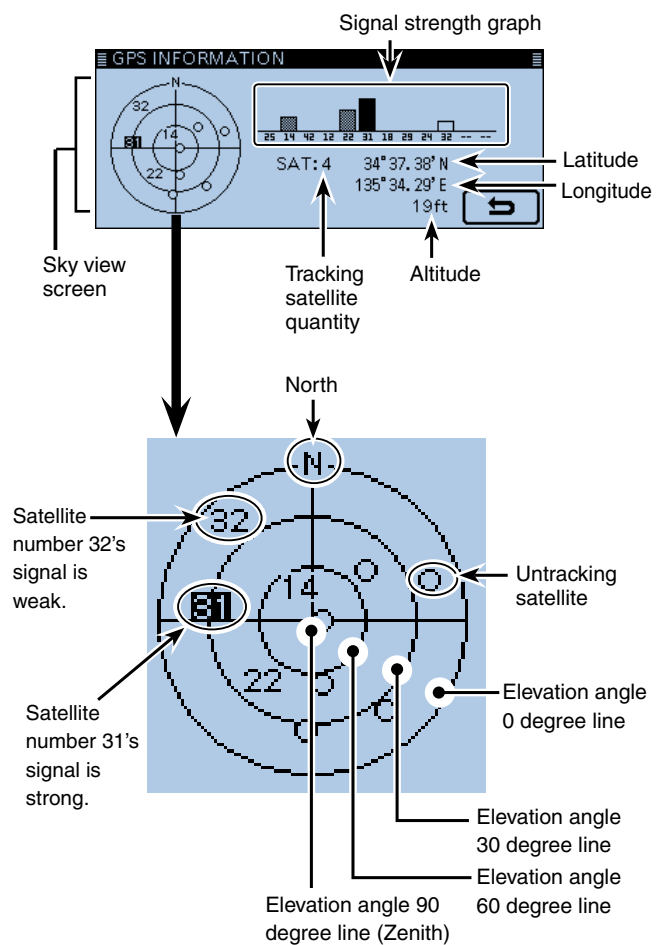
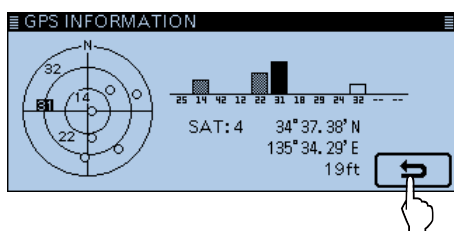

Transmitting GPS data (D-PRS and NMEA)

◇ Type of position data

GPS position data has two types of TX mode: D-PRS and NMEA. Moreover, in the D-PRS mode, you can select a TX format from Position (Mobile station/Base station), Object, Item and Weather.

Type of position data for transmission

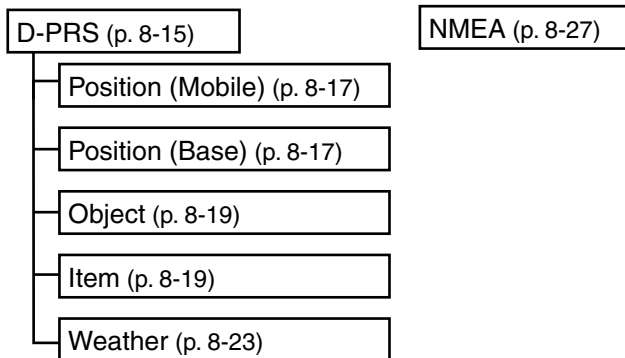

- **D-PRS:** D-PRS is a function that simultaneously sends position data received from the internal or external GPS receiver, using the slow speed data packet space, along with voice.
- **Mobile:** A station operating while moving.
 - You can transmit direction and speed information.
- **Base:** A station operating at home or in a building.
 - You can transmit the TX power level, height, antenna gain and antenna direction information.
- **Object:** A station transmitting specific position data. An event notice, earthquake information, satellite track information, and so on, can be transmitted. You can add a time stamp data to the object signal.
- **Item:** A station transmitting specific position data, not containing a time data. A position information such as a traffic accident, lighthouse, antenna or DV access point location, and so on, can be transmitted. You cannot add a time stamp data to the Item signal.
- **Weather:** A station transmitting a weather information received from a weather device.
- **NMEA:** A station transmitting position data (NMEA0183) received from the internal or external GPS receiver.

◇ Setting the GPS TX mode

To transmit in the D-PRS or NMEA mode, set the GPS TX mode.

If the TX information setting is finished, you can easily turn the GPS TX mode ON or OFF in the operating mode setting window.

See the specified page as described to the left for setting the TX information for D-PRS or NMEA.

- ① Touch the Mode icon.
 - Opens the operating mode setting window.

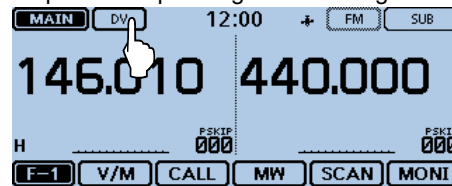

- ② Touch [GPS].
 - Opens the GPS TX mode setting window.

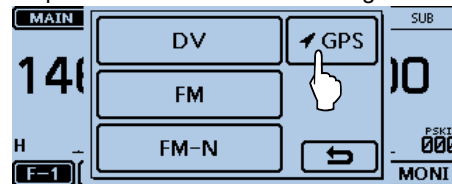

- ③ Touch "D-PRS."
 - Closes the GPS TX mode setting window, and then displays "DV" with a small arrow icon.

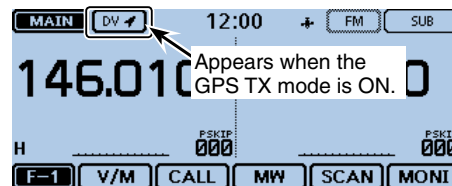
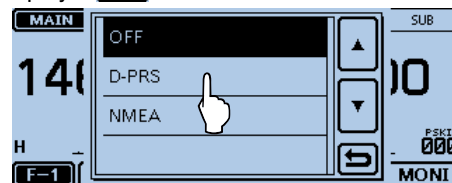

For users who have a D-STAR transceiver model prior to the ID-5100A/E:

The GPS TX mode, "GPS (DV-G)" and "GPS-A (DV-A)," are now called as "NMEA" and "D-PRS."

- GPS (DV-G) → NMEA
- GPS-A (DV-A) → D-PRS

For users who have one of the following models:

(ID-800H, IC-91AD/E91, IC-U82, IC-V82, IC-7100, ID-51A/E, ID-31A/E, IC-9100, IC-80AD/E80D, ID-880H/E880, IC-92AD/E92D, IC-2820H/E2820)

When you receive a D-PRS position (Base), Object, Item or Weather signal, position data will not be displayed.

Transmitting D-PRS data

When D-PRS is selected in the GPS TX mode, you can transmit D-PRS data.

When operating in the D-PRS mode, the following codes are transmitted to the PC.

D-PRS code is based on APRS® code.

(APRS®: Automatic Packet Reporting System).

◇ D-PRS

D-PRS is a function that simultaneously sends position data received from the internal or external GPS receiver, using the slow speed data packet space, along with voice in the DV mode.

In an analog mode, you can transmit or receive only voice or data at one time. However a D-PRS capable radio can transmit or receive message data or GPS position data at the same time voice is being transmitted or received.

I-GATE is required to send a position data to the APRS server.

NOTE:

- If “GPS select” is set to “Manual,” the position data entered in “Manual Position” is change to the D-PRS format data to transmit. (p. 12-20)
(GPS > GPS Set > **Manual Position**)
- Please note that if “GPS Auto TX” is set to any other setting than “OFF,” the data is transmitted according to the set time. (p. 8-41)
(GPS > **GPS Auto TX**)

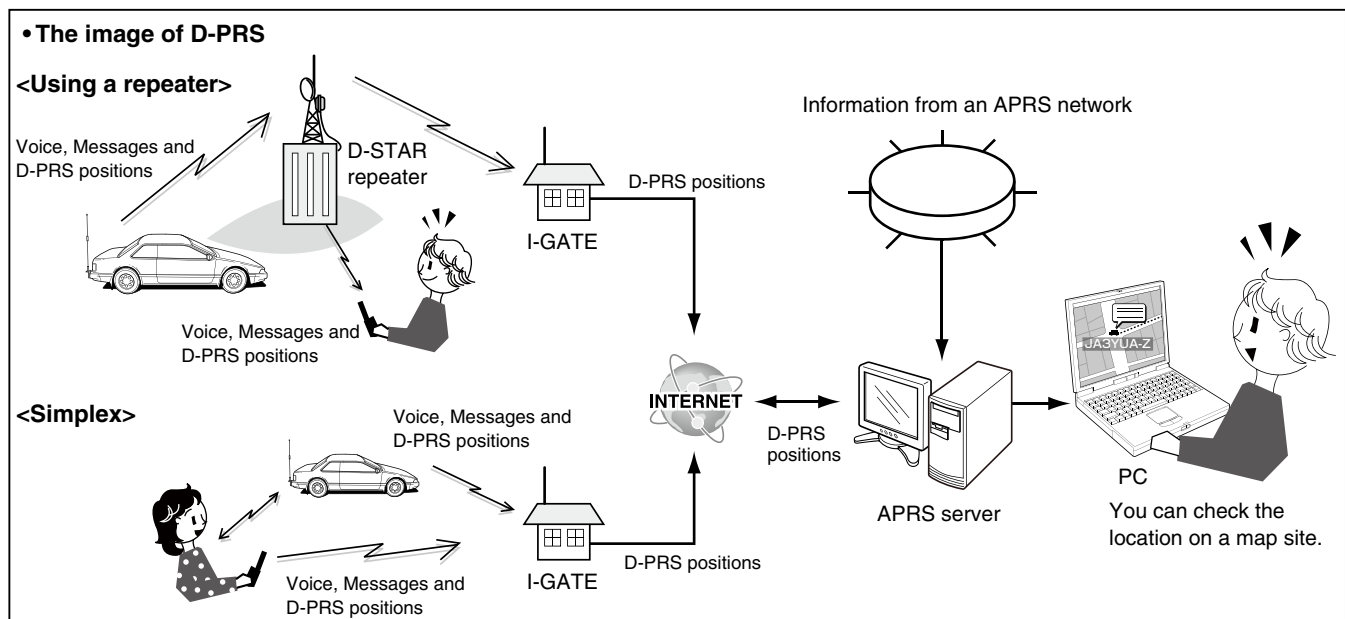

◇ Operating D-PRS

To transmit in D-PRS, follow the steps below, and for more details, see the pages listed along with the steps.

1. “MY”(Your own call sign) entering (p. 6-5)
2. Receiving GPS data (p. 8-3)
3. Set GPS TX MODE to D-PRS (p. 8-17)
Set transceivers prior to the ID-5100A/E to D-PRS.
4. Set TX information (pp. 8-17 to 8-24)
You must set SSID and symbol.
(GPS > GPS TX Mode > D-PRS > TX Format > Position, Object, item or Weather > **SSID, Symbol**)

↓
Complete (You can transmit in D-PRS)

For your reference:

In D-PRS, you can transmit earthquake or weather information, in addition to position information.
(GPS > GPS TX mode > **TX format**)

[TX format of D-PRS]

- Position (Mobile/Base):
Used to transmit position data.
- Object: Used to transmit specific position data.
(Time information can be included.)
- Item: Used to transmit specific position data.
(Time information cannot be included.)
- Weather: Used to transmit weather information.

Transmitting D-PRS data (Continued)

◇ Displayed items

Depending on the TX format, the setting items differ.

	D-PRS								
	Position		Object			Item			Weather
	Mobile	Base	Data extension: OFF	Data extension: Course/Speed	Data extension: Power/Height/Gain/Directivity	Data extension: OFF	Data extension: Course/Speed	Data extension: Power/Height/Gain/Directivity	
Unproto Address	✓	✓	✓	✓	✓	✓	✓	✓	
Comment	✓	✓	✓	✓	✓	✓	✓	✓	✓
Altitude	✓	✓							
Object Name/Item Name			✓	✓	✓	✓	✓	✓	
Data Type			✓	✓	✓	✓	✓	✓	
Position information (Latitude/Longitude/Altitude)			✓	✓	✓	✓	✓	✓	
Data Extension	✓	✓	✓	✓	✓	✓	✓	✓	
Course				✓			✓		
Speed				✓			✓		
Power		✓			✓			✓	
Height		✓			✓			✓	
Gain		✓			✓			✓	
Directivity		✓			✓			✓	
Symbol	✓	✓	✓	✓	✓	✓	✓	✓	✓
SSID	✓	✓	✓	✓	✓	✓	✓	✓	✓
Time stamp	✓	✓	✓	✓	✓				✓

✓: Displayed

The displayed order of the items may differ, depending on the TX format.

Transmitting D-PRS data (Continued)

◇ Setting D-PRS Position (Mobile/Base)

Set to transmit as a D-PRS Position.

1. Setting the GPS TX Mode to D-PRS

- ① Touch [MENU].
- ② Touch "GPS TX Mode."
(GPS > **GPS TX Mode**)
 - If the item is not displayed, touch [▲] or [▼] one or more times to select another page.
- ③ Touch "D-PRS."

2. Displaying the Unproto Address

The default address should be used, and editing is not recommended.

- ④ Touch "Unproto Address."
 - The default setting is "API510,DSTAR*."
- ⑤ Touch [↵].
 - Returns to the previous screen.

3. Setting the TX format to "Position"

Set the TX format.

- ⑥ Touch "TX Format."
- ⑦ Touch "Position."

4. Setting the Symbol

Select the desired symbol that represents your operating situation.

The selected symbol channel's symbols (1~4) are transmitted in addition to the position data.

- ⑧ Touch "Symbol."
- ⑨ Touch the desired symbol channel.
 - 1:Car, 2: Van, 3: Truck, and 4:House QTH (VHF) are set as defaults.
 - See page 12-20 for editing a symbol or selecting other symbol details.

5. Setting the SSID

To assist in identifying a station's type, the displayed APRS® (Automatic Packet Reporting System) based SSID is added after the D-PRS data call sign.

The way to add SSID's differs, depending on whether you enter a space in your call signs or not.

⑩ Touch "SSID."

⑪ Touch the desired SSID to set.

- To select another page, touch [▲] or [▼] one or more times.
- ---: The space in call sign is converted to "-." If no text is programmed after the space, the space will be deleted, and the space is not converted to "-." Example: JA3YUA **A** > JA3YUA-**A**
- (-0): No SSID is added. If a call sign includes a space, any text or digit after the space will be deleted.
- -1~-15: Adds an SSID of -1 to -15 to your call sign. Example: SSID is "-9."
JA3YUA **A** > JA3YUA-**9**
- -A~-Z: Adds an SSID of -A to -Z to your call sign. Example: SSID is "-Z."
JA3YUA **A** > JA3YUA-**Z**

About the SSID

To assist in identifying a station's type, designated call sign SSIDs are used in D-PRS (APRS®), according to a common guideline.

The guideline may be changed when the infrastructure environment, such as a product or network, is changed.

Please check the latest guideline in the web site related to D-PRS and APRS®, and correctly set.

Transmitting D-PRS data

◇ Setting D-PRS Position (Mobile/Base) (Continued)

6. Entering a comment

Enter a comment, and transmit it with the D-PRS position data.

The number of characters you can enter differs, depending on the data extension and altitude settings. (See to the right.)

Data Extension	Altitude	Characters entered (Max.)
OFF	OFF	43 (Default)
OFF	ON	35
Course/Speed	OFF	36
Course/Speed	ON	28
Power/Height/Gain/Directivity	OFF	36
Power/Height/Gain/Directivity	ON	28

- 12 Touch "Comment."
- 13 Touch the desired comment field for 1 second.
- 14 Touch "Edit."
 - Opens the "Comment" screen.
- 15 Touch the keypad.
 - Enters the desired character or symbol.
 - In the Alphabet entry mode, touch "↑" to enter an upper case letter once, or touch "▲" to continuously enter upper case letters. Touch "▶" to enter lower case letters.
 - Touch [[ab]] or [[12]], and then touch [ab], [12] or [(!"#)] to select the desired entry mode.
 - Touch "ab↔12" to toggle between the Alphabet entry and Number entry modes.
 - Touch "SPACE" to enter a space.
 - Touch [CLR] to delete the selected character, symbol or number.
 - Touch [QUICK], and then touch "Switch to Tenkey" to switch the keyboard type.

Selectable characters and symbols
A to Z, a to z, 0 to 9, ! " # \$ % & ' () * + , - . / : ; < = > ? @ [\] ^ _ ` { } ~ (space)

- The symbol "1" shows the transmittable comment range. Please note that the characters that exceed the range will not be transmitted.
- 16 Touch [←] to move the cursor backwards, or touch [→] to move the cursor forwards.
- 17 Repeat steps 15 and 16 to enter a comment, including spaces.
- 18 After entering, touch [ENT].
- 19 Touch [↵](□) to return to the previous screen.

7. Setting the Time Stamp

Set the time stamp function to transmit the received time data in UTC (Universal Time Coordinated) time.

- 20 Touch "Time Stamp."
- 21 Touch the desired time stamp.
 - OFF: Does not transmit the time information.
 - DHM: Transmits the time stamp in the Day, Hour, and Minute format.
 - HMS: Transmits the time stamp in the Hour, Minute, and Second format.
- 22 Touch [▼] to select the next page.

8. Setting the Altitude

Set the altitude data transmission.

- 23 Touch "Altitude."
- 24 Touch "ON."

NOTE:

If you transmit with the altitude setting ON, the character string is included in a comment on the products that cannot display the altitude. (IC-9100, IC-80AD, IC-E80D, ID-880H, ID-E880, IC-92AD, IC-E92D, IC-U82, IC-V82)

9. Setting the Data Extension

Set the data extension of your station's information.

- 25 Touch "Data Extension."
- 26 Touch the desired option to transmit.
 - OFF: Does not transmit any information.
 - Course/Speed: Transmits the course and speed data in addition to the position data.
 - Power/Height/Gain/Directivity: Transmits the TX power level, height, antenna gain and antenna direction, in addition to the position data.

10. Setting the TX power

This item appears when "9. Setting Data Extension" is set to "Power/Height/Gain/Directivity."

Select the TX power level of the base station, to transmit in addition to the position data.

- 27 Touch "Data Extension."
- 28 Touch the desired option between 0, 1, 4, 9, 16, 25, 36, 49, 64, and 81W.

Transmitting D-PRS data

◇ Setting D-PRS Position (Mobile/Base) (Continued)

11. Setting the antenna height

/// This item appears when “9. Setting Data Extension” is set to “Power/Height/Gain/Directivity.”

Select the height of the base station’s antenna, to transmit in addition to the position data.

- ⑲ Touch “Height.”
- ⑳ Touch the desired option between 10, 20, 40, 80, 160, 320, 640, 1280, 2560, and 5120 feet.*
*You can change the unit to “meter.” (p. 12-58)
- ㉑ Touch [▼] to select the next page.

12. Setting the antenna gain

/// This item appears when “9. Setting Data Extension” is set to “Power/Height/Gain/Directivity.”

Select the gain of the base station’s antenna, to transmit in addition to the position data.

- ㉒ Touch “Gain.”
- ㉓ Touch the desired option between 0 and 9 dB.

13. Setting the antenna directivity

/// This item appears when “9. Setting Data Extension” is set to “Power/Height/Gain/Directivity.”

Select the direction the base station’s antenna was pointing, to transmit in addition to the position data.

- ㉔ Touch “Directivity.”
- ㉕ Touch the desired option between Omni, 45°NE, 90°E, 135°SE, 180°S, 225°SW, 270°W, 315°NW and 360°N.
- ㉖ Touch [MENU].
• Closes the Menu screen.

◇ **Setting D-PRS Object/Item**

Set to transmit as a D-PRS Object or Item station.

1. Setting the GPS TX Mode to D-PRS

- ① Touch [MENU].
- ② Touch “GPS TX Mode.”
(GPS > **GPS TX Mode**)
• If the item is not displayed, touch [▲] or [▼] one or more times to select another page.
- ③ Touch “D-PRS.”

2. Unproto Address Display

The default address should be used, and editing is not recommended.

- ④ Touch “Unproto Address.”
• The default setting is “API510,DSTAR*.”
- ⑤ Touch [↵].
• Returns to the previous screen.

3. Setting the TX format to “Object” or “Item”

Set the TX format.

- ⑥ Touch “TX Format.”
- ⑦ Touch “Object” or “Item.”

4. Entering Object name or Item name

Set an Object or Item name of up to 9 characters, such as an event information or location.

- ⑧ Touch “Object Name” or “Item Name.”
• Open the “Object Name” screen.
- ⑨ Touch the keypad.
• Enters the desired character or symbol.
• In the Alphabet entry mode, touch “↑” to enter an upper case letter once, or touch “↑↑” to continuously enter upper case letters. Touch “⇩” to enter lower case letters.
• Touch [[ab]] or [[12]], and then touch [ab], [12] or [(!#)] to select the desired entry mode.
• Touch “ab⇌12” to toggle between the Alphabet entry and Number entry modes.
• Touch “SPACE” to enter a space.
• Touch [CLR] to delete the selected character, symbol or number.
• Touch [QUICK], and then touch “Switch to Tenkey” to switch the keyboard type.

Selectable characters and symbols
A to Z, a to z, 0 to 9, ! " # \$ % & ' () * + , - . / : ; < = > ? @ [\] ^ _ ` { } ~ (space)

- ⑩ Touch [←] to move the cursor backwards, or touch [→] to move the cursor forwards.
- ⑪ Repeat steps ⑨ and ⑩ to enter a comment, including spaces.
- ⑫ After entering, touch [ENT].

☞ Continued on the next page.

Transmitting D-PRS data

◇ Setting D-PRS Object/Item (Continued)

5. Setting Data type

Set the Object or Item station's status.

⑬ Touch "Data Type."

⑭ Touch the desired option.

(For an Object station)

- Live Object: The Object station is valid.
- Killed Object: The Object station is invalid.

(For an Item station)

- Live Item: The Item station is valid.
- Killed Item: The Item station is invalid.

6. Setting Symbol

Select the desired symbol that represents an Object or Item station.

⑮ Touch "Symbol."

⑯ Touch the desired symbol.

- See page 12-24 to edit a symbol details.
- "Radio" is set as the default.

7. Entering a Comment

Enter a comment to transmit as an Object or Item station.

The number of characters you can enter differs, depending on the data extension and altitude settings. (p. 8-18)

Data Extension	Altitude	Characters entered (Max.)
OFF	No data	43 (Default)
OFF	Set	35
Course/Speed	No data	36
Course/Speed	Set	28
Power/Height/Gain/Directivity	No data	36
Power/Height/Gain/Directivity	Set	28

⑰ Touch "Comment."

⑱ Touch [QUICK].

⑲ Touch "Edit."

- Opens the "Comment" screen.

⑳ Touch the keypad.

- Enters the desired character or symbol.
- In the Alphabet entry mode, touch "↑" to enter an upper case letter once, or touch "▲" to continuously enter upper case letters. Touch "▶" to enter lower case letters.
- Touch [[ab]] or [[12]], and then touch [ab], [12] or [(!"#)] to select the desired entry mode.
- Touch "ab↔12" to toggle between the Alphabet entry and Number entry modes.
- Touch "SPACE" to enter a space.
- Touch [CLR] to delete the selected character, symbol or number.
- Touch [QUICK], and then touch "Switch to Tenkey" to switch the keyboard type.

Selectable characters and symbols
A to Z, a to z, 0 to 9, ! " # \$ % & ' () * + , - . / : ; < = > ? @ [\] ^ _ ` { } ~ (space)

- The symbol "J" shows the transmittable comment range. Please note that the characters that exceed the range will not be transmitted.

㉑ Touch [←] to move the cursor backwards, or touch [→] to move the cursor forwards.

㉒ Repeat steps ㉑ and ㉑ to enter a comment, including spaces.

㉓ After entering, touch [ENT].

㉔ Touch [↶] to return to the previous screen.

㉕ Touch [▼] to select the next page.

☞ Continued on the next page.

Transmitting D-PRS data

◇ Setting D-PRS Object/Item (Continued)

8. Setting the Position

Set the position information of an Object or Item station.

For example, if you want to transmit traffic accident information as an Item station, set the location where the accident has happened.

If the position data is entered in the GPS memory, you can easily set the position from the memory.

- ②6 Touch "Position."
- ②7 Touch [QUICK].
- ②8 Touch "Edit."
 - Opens the "POSITION EDIT" screen.
- ②9 Touch "LATITUDE."
 - Opens the latitude edit screen.
- ③0 Enter the latitude.
 - Touch "N/S" to toggle between north and south.
 - Touch [CE] to clear the entered number.
 - Touch [←] to move the cursor backwards, or touch [→] to move the cursor forwards.
- ③1 Touch [ENT].
- ③2 Touch "LONGITUDE."
 - Opens the longitude edit screen.
- ③3 Enter the longitude.
 - Touch "E/W" to toggle between east and west.
 - Touch [CE] to clear the entered number.
 - Touch [←] to move the cursor backwards, or touch [→] to move the cursor forwards.
- ③4 Touch [ENT].
- ③5 Touch "ALTITUDE."
 - Opens the altitude edit screen.
- ③6 Enter the altitude.
 - After entering a digit, touch "+/-" to toggle between plus and minus.
 - Touch [CE] to clear the entered number.
 - Touch [←] to move the cursor backwards, or touch [→] to move the cursor forwards.
- ③7 Touch [ENT].
- ③8 Touch [<<Write>>].
 - Opens the "Write?" window.
- ③9 Touch [YES].
 - Writes the entered position data.
- ④0 Touch [↵] to return to the previous screen.

When you touch "Capture From GPS" or "Set From GPS Memory" in step ②8, you can capture the position from the GPS, or set the Object or Item's position from the GPS memory.

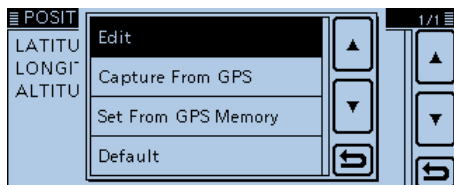

9. Setting the Data Extension

Set the data extension of an Object or Item station's information.

- ④1 Touch "Data Extension."
- ④2 Touch the desired option to transmit.
 - OFF: Does not transmit any information.
 - Course/Speed: Transmits the course and speed data in addition to the position data.
 - Power/Height/Gain/Directivity: Transmits the TX power level, height, antenna gain and antenna direction, in addition to the position data.

10. Setting the Course

⚡ This item appears when "9. Setting Data Extension" is set to "Course/Speed."

Set the Object or Item station's course when the station moves.

- ④3 Touch "Data Extension."
- ④4 Enter the Object or Item station's course to between 0° and 360°.
 - Touch [CE] to clear the entered number.
 - Touch [←] to move the cursor backwards, or touch [→] to move the cursor forwards.

11. Setting the Speed

⚡ This item appears when "9. Setting Data Extension" is set to "Course/Speed."

Set the Object or Item station's speed.

- ④5 Touch "Speed."
 - ④6 Enter the Object or Item station's speed to between 0 and 1150 mph*.
 - Touch [CE] to clear the entered number.
 - Touch [←] to move the cursor backwards, or touch [→] to move the cursor forwards.
- *You can change the unit to "km/h" or "knots." (p. 12-59)

12. Setting the TX power

⚡ This item appears when "9. Setting Data Extension" is set to "Power/Height/Gain/Directivity."

Select the TX power level of the Object or Item station if the station is a repeater, node, access point, and so on and an antenna is installed.

- ④7 Touch "Data Extension."
- ④8 Touch the desired option between 0, 1, 4, 9, 16, 25, 36, 49, 64, and 81W.

☞ Continued on the next page.

Transmitting D-PRS data

◇ Setting D-PRS Object/Item (Continued)

13. Setting the antenna height

/// This item appears when “9. Setting Data Extension” is set to “Power/Height/Gain/Directivity.”

Select the height of the Object or Item’s antenna if the station is a repeater, node, access point, and so on and an antenna is installed.

④⑨ Touch “Height.”

⑤⑩ Touch the desired option between 10, 20, 40, 80, 160, 320, 640, 1280, 2560, and 5120 feet.*

*You can change the unit to “meter.” (p. 12-58)

⑤⑪ Touch [▼] to select the next page.

14. Setting the antenna gain

/// This item appears when “9. Setting Data Extension” is set to “Power/Height/Gain/Directivity.”

Select the gain of the Object or Item antenna.

⑤⑫ Touch “Gain.”

⑤⑬ Touch the desired option between 0 and 9 dB.

15. Setting the antenna directivity

/// This item appears when “9. Setting Data Extension” is set to “Power/Height/Gain/Directivity.”

Select the direction the base Object or Item station’s antenna was pointing.

⑤⑭ Touch “Directivity.”

⑤⑮ Touch the desired option between Omni, 45°NE, 90°E, 135°SE, 180°S, 225°SW, 270°W, 315°NW and 360°N.

16. Setting the SSID

To assist in identifying a station’s type, the displayed APRS® (Automatic Packet Reporting System) based SSID is added after the D-PRS data call sign.

The way to add SSID’s differs, depending on whether you enter a space in your call signs or not.

⑤⑯ Touch “SSID.”

⑤⑰ Touch the desired SSID to set.

- To select another page, touch [▲] or [▼] one or more times.

- ---: The space in call sign is converted to “-.” If no text is programmed after the space, the space will be deleted, and the space is not converted to “-.”
Example: JA3YUA A > JA3YUA-A

- (-0): No SSID is added. If a call sign includes a space, any text or digit after the space will be deleted.

- -1~-15: Adds an SSID of -1 to -15 to your call sign.
Example: SSID is “-9.”

JA3YUA A > JA3YUA-9

- -A~-Z: Adds an SSID of -A to -Z to your call sign.
Example: SSID is “-Z.”

JA3YUA A > JA3YUA-Z

About the SSID

To assist in identifying a station’s type, designated call sign SSIDs are used in D-PRS (APRS®), according to the common guideline.

The guideline may be changed when the infrastructure environment, such as a product or network, is changed.

Please check the latest guideline in the web site related on the D-PRS or APRS®, and correctly set.

17. Setting Time Stamp

/// This item appears when the TX format is “Object.”

Set the time stamp function to transmit the time that the caller sent the Object station’s data in UTC (Universal Time Coordinated) time.

⑤⑱ Touch “Time Stamp.”

⑤⑲ Touch the desired time stamp.

- DHM : Transmits the time stamp in the Day, Hour, and Minute format.

- HMS : Transmits the time stamp in the Hour, Minute, and Second format.

⑥⑰ Touch [▼] to select the next page.

⑥⑱ Touch [MENU].

- Closes the Menu screen.

Transmitting D-PRS data (Continued)

◇ Setting D-PRS Weather

Set to transmit as a D-PRS Weather station.

1. Setting the GPS TX Mode to D-PRS

- ① Touch [MENU].
- ② Touch "GPS TX Mode."
(GPS > **GPS TX Mode**)
 - If the item is not displayed, touch [▲] or [▼] one or more times to select another page.
- ③ Touch "D-PRS."

2. Displaying the Unproto Address

The default address should be used, and editing is not recommended.

- ④ Touch "Unproto Address."
 - The default setting is "API510,DSTAR*."
- ⑤ Touch [↵].
 - Returns to the previous screen.

3. Setting the TX format to "Weather"

Set the TX format.

- ⑥ Touch "TX Format."
- ⑦ Touch "Weather."

4. Setting the Symbol

Select the desired symbol that represents weather station.

- ⑧ Touch "Symbol."
- ⑨ Touch the desired symbol.
 - See page 12-30 for editing a symbol details.
 - "WX Station" is set as the default.

5. Setting the SSID

To assist in identifying a station's type, the displayed APRS® (Automatic Packet Reporting System) based SSID is added after the D-PRS data call sign.

The way to add SSID's differs, depending on whether you enter a space in your call signs or not.

- ⑩ Touch "SSID."
- ⑪ Touch the desired SSID to set.
 - To select another page, touch [▲] or [▼] one or more times.
 - ---: The space in call sign is converted to "-." If no text is programmed after the space, the space will be deleted, and the space is not converted to "-."
 - Example: JA3YUA **A** > JA3YUA-**A**
 - (-0): No SSID is added. If a call sign includes a space, any text or digit after the space will be deleted.
 - -1~-15: Adds an SSID of -1 to -15 to your call sign.
 - Example: SSID is "-9."
 - JA3YUA **A** > JA3YUA-**9**
 - -A~-Z: Adds an SSID of -A to -Z to your call sign.
 - Example: SSID is "-Z."
 - JA3YUA **A** > JA3YUA-**Z**

About the SSID

To assist in identifying a station's type, designated call sign SSIDs are used in D-PRS (APRS®), according to the common guideline.

The guideline may be changed when the infrastructure environment, such as a product or network, is changed.

Please check the latest guideline in the web site related on the D-PRS or APRS®, and correctly set.

Transmitting D-PRS data

◇ Setting D-PRS Weather (Continued)

6. Entering a Comment

Enter a comment of up to 43 characters to transmit as a D-PRS Weather station.

- ⑫ Touch "Comment."
- ⑬ Touch [QUICK].
- ⑭ Touch "Edit."
 - Opens the "Comment" screen.
- ⑮ Touch the keypad.
 - Enters the desired character or symbol.
 - In the Alphabet entry mode, touch "⇧" to enter an upper case letter once, or touch "⇩" to continuously enter upper case letters. Touch "⇲" to enter lower case letters.
 - Touch [[ab]] or [[12]], and then touch [ab], [12] or [(!"#)] to select the desired entry mode.
 - Touch "ab⇄12" to toggle between the Alphabet entry and Number entry modes.
 - Touch "SPACE" to enter a space.
 - Touch [CLR] to delete the selected character, symbol or number.
 - Touch [QUICK], and then touch "Switch to Tenkey" to switch the keyboard type.

Selectable characters and symbols
A to Z, a to z, 0 to 9, ! " # \$ % & ' () * + , - . / : ; < = > ? @ [\] ^ _ ` { } ~ (space)

- The symbol "J" shows the transmittable comment range. Please note that the characters that exceed the range from "J" will not be transmitted.
- ⑯ Touch [←] to move the cursor backwards, or touch [→] to move the cursor forwards.
- ⑰ Repeat steps ⑮ and ⑯ to enter a comment, including spaces.
- ⑱ After entering, touch [ENT].
- ⑲ Touch [↶] to return to the previous screen.
- ⑳ Touch [▼] to select the next page.

7. Setting the Time Stamp

Set the time stamp function to transmit the received time data in UTC (Universal Time Coordinated) time.

- ㉑ Touch "Time Stamp."
- ㉒ Touch the desired time stamp.
 - OFF : Does not transmit the time information.
 - DHM : Transmits the time stamp in the Day, Hour, and Minute format.
 - HMS : Transmits the time stamp in the Hour, Minute, and Second format.
- ㉓ Touch [MENU].
 - Closes the Menu screen.

Transmitting D-PRS data (Continued)

◇ **Weather station transmission**

When you transmit as a weather station, you should set the weather station's settings, and input the weather data to the [DATA] terminal.

You can input the weather data from a third party's weather device by converting it to the APRS weather format in your PC or microcomputer.

After completing the weather station's settings, and inputting the weather data, you can transmit as a weather station.

NOTE:
If the weather data is not input to the [DATA] terminal, you cannot transmit as a weather station.

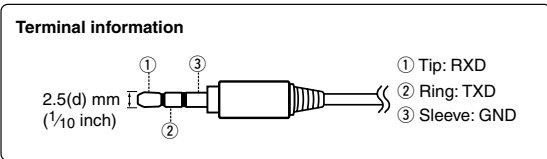
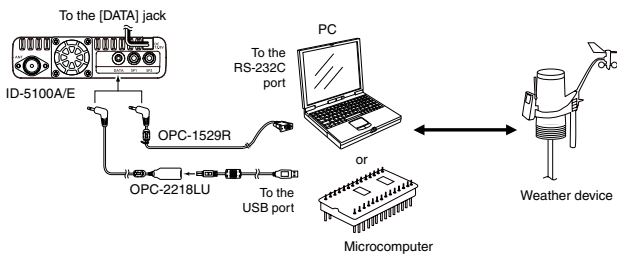

◇ **Confirming the weather data input**

You can confirm whether or not the weather data is input to the [DATA] terminal.

- ① Set the GPS TX Mode to "D-PRS," and the TX format to "Weather." (p. 8-23, p. 8-24)
- ② In the normal operation screen (Example: VFO, DR screen), touch [QUICK], and then touch "GPS Information."

- Opens the "GPS INFORMATION" screen.
- The weather information screen appears as shown below if the weather data is input to the [DATA] terminal.

When you can see the weather information screen, you can transmit as a weather station. If "-" is displayed on the weather information screen, the weather data does not input to the [DATA] terminal. In this case, check the input data settings.

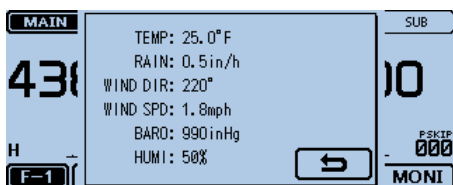

◇ **Application setting**

Configure the communication software as follows.

- Port: The COM port number that is used by the ID-5100A/E.*¹
- Baud rate: 4800/9600 bps*²
- Data: 8 bit
- Parity: none
- Start: 1 bit
- Stop: 1 bit
- Flow control: none

*¹ Depending on the PC environment, the COM port number used by the ID-5100A/E may be higher than 5. In such case, use an application that can set it to higher than 5.

*² Set the baud rate in the "Data Speed" item. (Function > **Data Speed**) (p. 12-56)

◇ **About the weather data content**

The weather data should be input according to the format (based on the APRS® Weather Data) as shown below.

Example:

220/004g005t077r000p000P000h50b09900 End code
 ① ② ③ ④ ⑤ ⑥ ⑦ ⑧ ⑨

	Value	Unit
① Wind direction	000 to 360	°
② Wind speed	000 to 999	mph
③ Gust speed	g000 to g999	mph
④ Temperature	t-99 to t-01, t000 to t999	°F
⑤ Rainfall	r000 to r999* ¹	inch
⑥ Rainfall (24 Hours)	p000 to p999* ¹	inch
⑦ Rainfall (Midnight)	P000 to P999* ¹	inch
⑧ Humidity	h00, h01 to h99 (h00 indicates 100%.)	%
⑨ Barometric pressure	b00000 to b99999* ²	hPa, mb

*¹ The last two digits indicate the two decimal place.

*² The last digit indicates the one decimal place.

- If you have no data, enter a space or "." (period) instead of a number.
(Example: ".../...g...t077r000p...P...h50b....")
- Enter <CR>, <LF> or <CR><LF> for an end code.

Transmitting D-PRS data (Continued)

◇ **Displaying your position using a mapping program**

If you transmit to an I-GATE station, and then enter the call sign information on the internet map website, the set symbol is displayed.

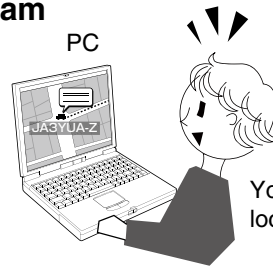

You can check the location at a map site.

For your reference

D-PRS data content

D-PRS data content are shown below.

◇ Position (Mobile)

(e.g.) JA3YUA-A>API510,DSTAR*:/002338h3437.38N/13534.29E>090/002/A=000012ID-5100 OP.SATOH
 ① ② ③ ④ ⑦ ⑧ ⑨ ⑩ ⑨ ⑪ ⑬ ⑭

◇ Position (Base)

(e.g.) JA3YUA-A>API510,DSTAR*:/002338h3437.38N/13534.29E-PHG5132/ID-5100 OP.SATOH
 ① ② ③ ④ ⑦ ⑧ ⑨ ⑩ ⑨ ⑫ ⑭

◇ Object

(e.g.) JA3YUA-A>API510,DSTAR*;;HAM FESTA*012345z3437.38N\13534.29Eh/2014.2.28 am10-pm4
 ① ② ③ ④ ⑤ ⑥ ⑦ ⑧ ⑨ ⑩ ⑨ ⑭

◇ Item

(e.g.) JA3YUA-A>API510,DSTAR*;)REPEATER!3454.00N/13536.00ErPHG5132/439.39MHz DV RPT JP3YHH A
 ① ② ③ ④ ⑤ ⑥ ⑧ ⑨ ⑩ ⑨ ⑫ ⑭

◇ Weather

(e.g.) JA3YUA-A>API510,DSTAR*:/012345z3454.00N/13536.00E_220/004g005t077r000p000P000h50b09900
 ① ② ③ ④ ⑦ ⑧ ⑨ ⑩ ⑨ ⑮ ⑯ ⑰ ⑱ ⑲ ⑳ ㉑ ㉒

- ① Call sign
- ② SSID
- ③ Unproto Address
- ④ D-PRS Data type
/ Position with time stamp
! Position without time stamp
; Object
) Item
- ⑤ Object Name/Item Name
- ⑥ Data Type
* Live Object
! Live Item
_ Killed Object/Killed Item
- ⑦ Time Stamp(UTC)
h Hour Minute Second
z Day Hour Minute
- ⑧ Latitude
- ⑨ Symbol
- ⑩ Longitude
- ⑪ Data Extension(Course/Speed)
Course:0 to 360°
Speed:0 to 999 knots

⑫ Data Extension(PHG codes)
PHG codes definitions

	0	1	2	3	4	5	6	7	8	9	
First: Power	0	1	4	9	16	25	36	49	64	81	(W)
Second: Height	10	20	40	80	160	320	640	1280	2560	5120	(feet)
Third: Gain	0	1	2	3	4	5	6	7	8	9	(dB)
Fourth: Directivity	omni	45°NE	90°E	135°SE	180°S	225°SW	270°W	315°NW	360°N	-	-

- ⑬ Altitude
-99999 to 999999 feet
- ⑭ Comment
- ⑮ Wind direction/Wind speed
Wind direction:0 to 360°
Wind speed: 0 to 999 mph
- ⑯ Gust speed
0 to 999 mph
- ⑰ Temperature
-99 to 999°F
- ⑱ Rainfall
0.00 to 9.99 inch
- ⑲ Rainfall (24 Hours)
0.00 to 9.99 inch
- ⑳ Rainfall (Midnight)
0.00 to 9.99 inch
- ㉑ Humidity
1 to 99%, 00=100%
- ㉒ Barometric pressure
0.0 to 9999.9 hPa

Transmitting NMEA data

Set a GPS sentence to transmit GPS data in the DV mode.

◆ Setting the GPS data sentence

- ① Touch [MENU].
- ② Touch “GPS TX Mode.”
(GPS > **GPS TX Mode**)
 - If the item is not displayed, touch [▲] or [▼] one or more times to select another page.

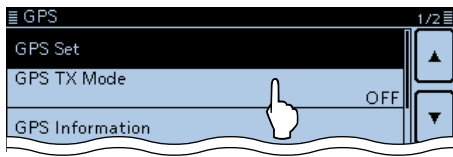

- ③ Touch “NMEA.”

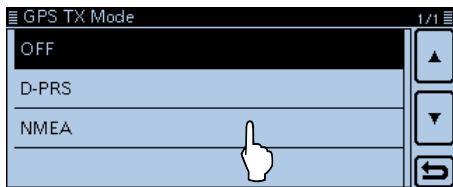

- ④ Touch “GPS Sentence.”
 - Opens the “GPS Sentence” screen.

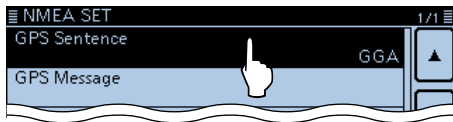

- ⑤ Touch the desired GPS sentence.
 - Touching “✓” cancels the setting.
 - The selectable GPS sentences are RMC, GGA, GLL, VTG, GSA and GSV. The GGA sentence is set to ON as the default GPS sentence.
 - Touch [QUICK], and touch “Default” to set the GPS sentence as the default.

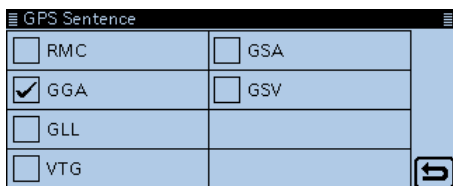

- ⑥ Repeat step ⑤ to set the GPS sentence.
 - A maximum of four GPS sentences can be set at a time.
- ⑦ Touch [MENU].
 - Closes the Menu screen.

• The display while transmitting NMEA data

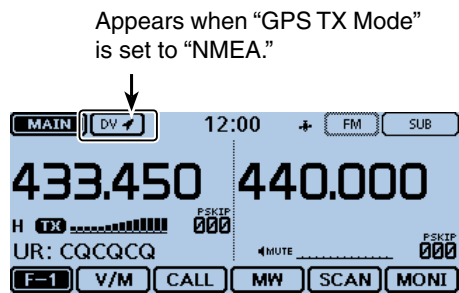

When you transmit, the set GPS sentence is also transmitted.

NOTE:

- Set the GSV sentence to OFF when sending the GPS message to a conventional digital transceivers (IC-2820H, IC-E2820, ID-800H, IC-91AD, IC-E91, IC-V82, IC-U82, IC-2200H).
The GSV sentence is incompatible with them.
- If “GPS Select” is set to “Manual,” the transceiver automatically sets the NMEA sentence and transmits it according to the position data in “Manual Position.” (p. 12-20)
(GPS > GPS Set > **Manual Position**)
- Please note that if “GPS Auto TX” is set to any other setting than “OFF,” the data is automatically transmitted according to the set time.
(GPS > **GPS Auto TX**)

• Contents of GPS sentence

Sentence	Lon /Lat	Alt	UTC	Date (UTC)	Status	2D /3D	COG (True)	SOG (knot)	Others
RMC	✓		✓	✓	✓		✓	✓	Mode Indicator,
GGA	✓	✓	✓		✓				Number of satellites in use, HDOP, Geoidal separation, Age of Differential GPS data
GLL	✓		✓		✓				Mode Indicator
VTG							✓	✓	COG (Magnetic north), SOG (km/h), Mode Indicator
GSA					✓	✓			ID numbers of satellites used in solution, PDOP, HDOP, VDOP
GSV									Total number of sentences, Sentence number, Total number of satellites in view, Satellite information (ID, Elevation, Azimuth, S/N)

Transmitting NMEA data (Continued)

◇ Entering the GPS message

Enter a GPS message of up to 20 characters to be transmitted with the position data.

Example: Adding “HELLO HOW ARE YOU?”

- ① Touch [MENU].
- ② Touch “GPS Message.”
(GPS > GPS TX Mode > NMEA > **GPS Message**)
 - If the item is not displayed, touch [▲] or [▼] one or more times to select another page.

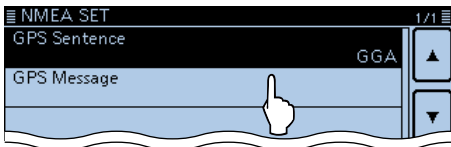

- ③ Touch [QUICK], and then touch “Edit.”
 - Opens the “GPS Message” edit screen.

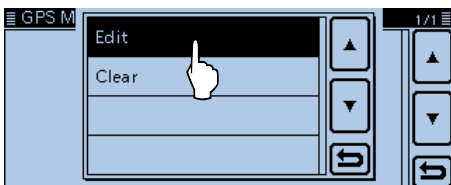

- ④ Touch the keypad.
 - Enters the desired character or symbol.
 - In the Alphabet entry mode, touch “⇧” to enter an upper case letter once, or touch “⇧” to continuously enter upper case letters. Touch “⇩” to enter lower case letters.
 - Touch [[ab]] or [[12]], and then touch [ab], [12] or [(!#)] (symbol) to select the desired entry mode.

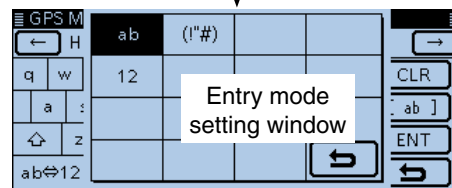
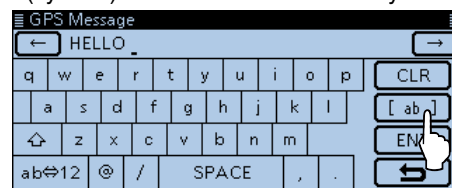

- Touch “ab⇌12” to toggle between the Alphabet entry and Number entry modes.
- Touch “SPACE” to enter a space.
- Touch [CLR] to delete the selected character, symbol or number.
- Touch [QUICK], and then touch “Switch to Tenkey” to switch the keyboard type.

Selectable characters and symbols
A to Z, a to z, 0 to 9, ! " # \$ % & ' () * + , - . / : ; < = > ? @ [\] ^ _ ` { } ~ (space)

- ⑤ Touch [←] to move the cursor backwards, or touch [→] to move the cursor forwards.
- ⑥ Repeat steps ④ and ⑤ to enter a GPS message of up to 20 characters, including spaces.
(Example: First, J, then A, then P, then A, then N, then (space), then >, then T, then O, then M.)
- ⑦ Touch [ENT].
 - Returns to the “GPS Message” screen.



- ⑧ Touch [MENU].
 - Closes the Menu screen.

Adding or editing GPS memory

◇ GPS memory

You can add GPS data to GPS Memory.

You can add your own position, other station's positions or any positions that are manually programmed.

The GPS Memory is capable of storing a total of 200 channels, and conveniently stored in up to 27 groups, from A to Z and "(No Group)." The A to Z groups can also be named.

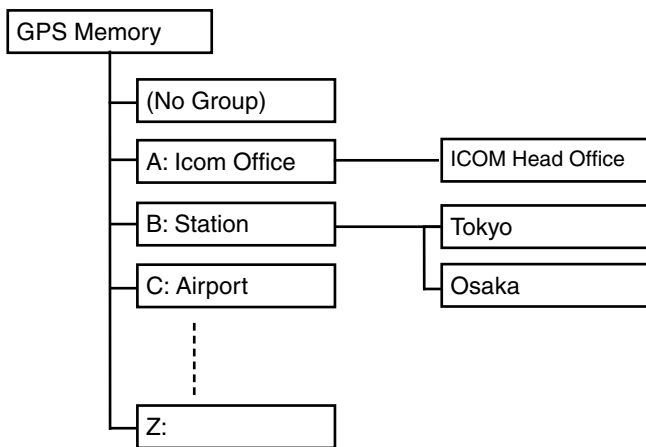

Group names are just example.

◇ Add a GPS memory

1. Adding GPS Memory and entering the edit mode

- ① Touch [MENU].
- ② Touch "GPS Message."
(GPS > GPS Memory)
 - If the item is not displayed, touch [▲] or [▼] one or more times to select another page.
 - All the previously added GPS memories are displayed.

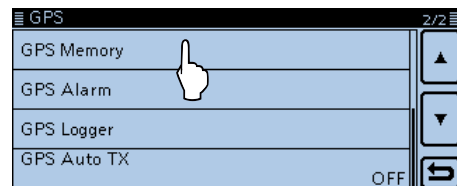

- ③ Touch "(No Group)."

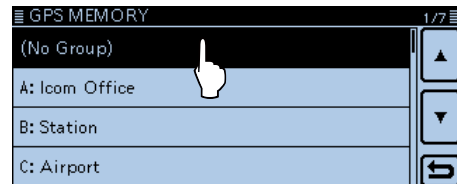

- ④ Push [QUICK].
- ⑤ Touch "Add."
 - Opens the "GPS MEMORY EDIT" screen.

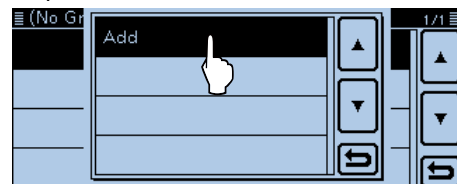

To edit the previously stored GPS memory, touch "Edit."

You can enter the content in the same way as described in "◇ Add a GPS memory."

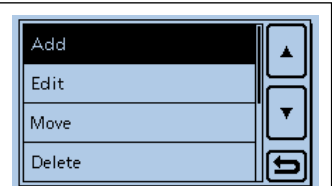

Adding or editing GPS memory

◇ Add a GPS memory (Continued)

2. Entering the GPS Memory name

- ⑥ Touch [NAME]
 - Enters the GPS Memory name edit mode.

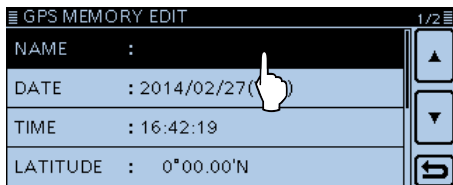

- ⑦ Touch the keypad.
 - Enters the desired character or symbol.
 - In the Alphabet entry mode, touch “⇧” to enter an upper case letter once, or touch “⇩” to continuously enter upper case letters. Touch “⇩” to enter lower case letters.
 - Touch [[ab]] or [[12]], and then touch [ab], [12] or [(!#)] to select the desired entry mode.

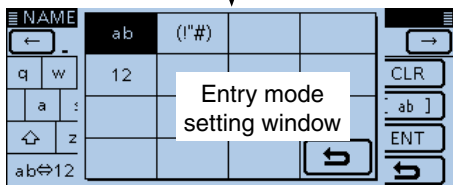
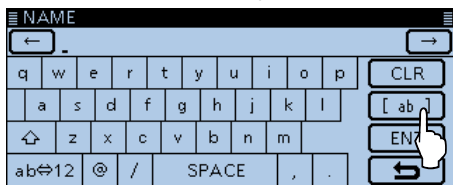

- Touch “ab⇌12” to toggle between the Alphabet entry and Number entry modes.
- Touch “SPACE” to enter a space.
- Touch [CLR] to delete the selected character, symbol or number.
- Touch [QUICK], and then touch “Switch to Tenkey” to switch the keyboard type.

Selectable characters and symbols
A to Z, a to z, 0 to 9, ! " # \$ % & ' () * + , - . / : ; < = > ? @ [\] ^ _ ` { } ~ (space)

- ⑧ Touch [←] to move the cursor backwards, or touch [→] to move the cursor forwards.
- ⑨ Repeat steps ⑦ and ⑧ to enter a GPS memory name of up to 16 characters, including spaces.
- ⑩ After entering, touch [ENT].
 - Returns to the “GPS MEMORY EDIT” screen.

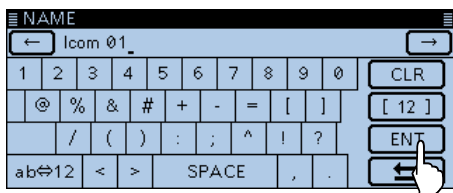

Example: When “Icom 01” is entered.

3. Entering the GPS Memory date

- ⑪ Touch “DATE.”
 - Enters the date edit mode.

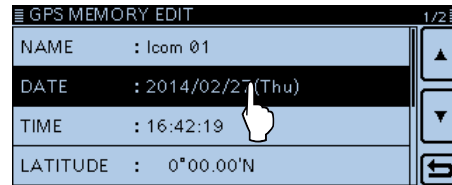

- ⑫ Touch [+] or [-] to enter the date.
 - From 2000/01/02 to 2099/12/30 can be entered.
- ⑬ Touch [↵].

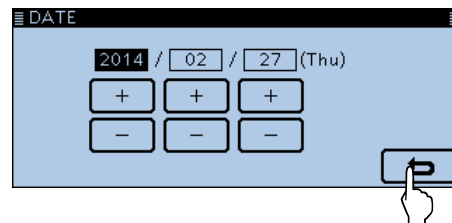

4. Entering the GPS memory time

- ⑭ Touch “TIME.”
 - Enters the time edit mode.

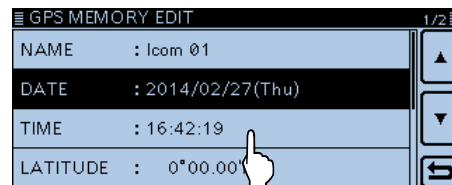

- ⑮ Touch [+] or [-] to enter the time.
 - From 00:00:00 to 23:59:59 can be entered.
- ⑯ Touch [↵].

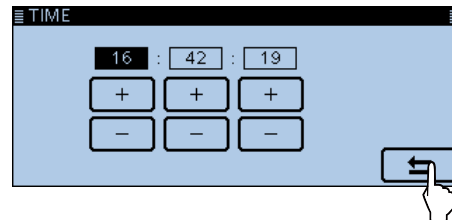

☞ Continued on the next page

Adding or editing GPS memory

◇ Add a GPS memory (Continued)

5. Entering the GPS latitude

⑰ Touch "LATITUDE."

• Enters the latitude edit mode.

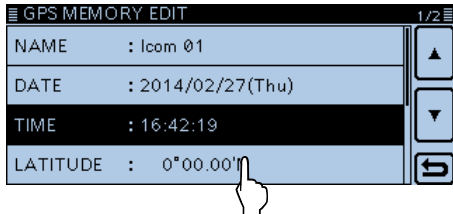

⑱ Enter the latitude.

- From 0°00.00' to 90°00.00' can be entered.
- If "ddd° mm' ss"" is selected as the latitude and longitude unit, you can enter between 0°00'00" to 90°00'00".
(Display > Display Unit > **Latitude/Longitude**)

⑲ Touch [←] to move the cursor backwards, or touch [→] to move the cursor forwards.

• Touch "N/S" to toggle between north and south.

⑳ Repeat steps ⑱ and ⑲ to enter the latitude.

㉑ Touch [ENT].

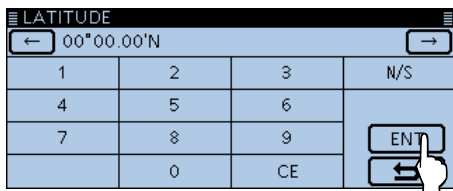

㉒ Touch [▼] to select the next page.

6. Entering the GPS longitude

⑳ Touch "LONGITUDE."

• Enters the longitude edit mode.

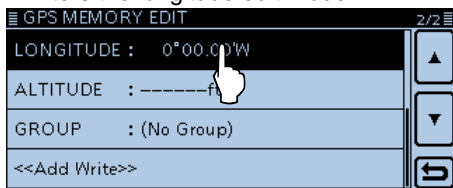

㉔ Enter the longitude.

- From 0°00.00' to 180°00.00' can be entered.
- If "ddd° mm' ss"" is selected as the latitude and longitude unit, you can enter between 0°00'00" to 180°00'00".
(Display > Display Unit > **Latitude/Longitude**)

㉕ Touch [←] to move the cursor backwards, or touch [→] to move the cursor forwards.

• Touch "E/W" to toggle between east and west.

㉖ Repeat steps ㉔ and ㉕ to enter the longitude.

㉗ Touch [ENT].

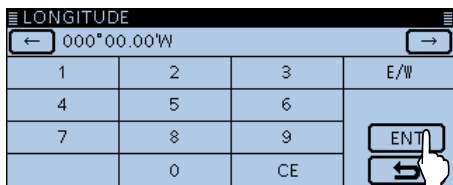

7. Entering the GPS altitude

㉘ Touch "ALTITUDE."

• Enters the altitude edit mode.

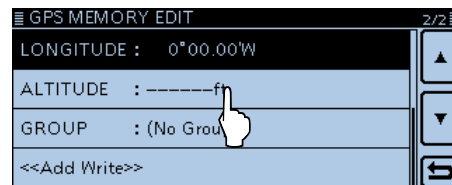

㉙ Enter the altitude.

- You can enter from -10.000 to +10.000 meters.
- After entering a digit, touch "+/-" to toggle between plus and minus.

㉚ Touch [ENT].

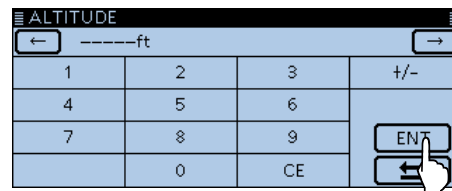

8. Entering the GPS memory group

㉛ Touch "GROUP."

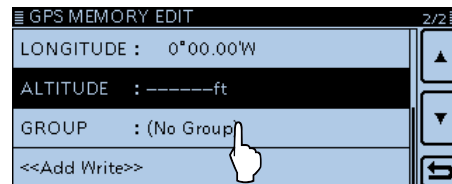

㉜ Touch the desired group between (No Group) or A to Z.

• A total of up to 200 memories can be stored.

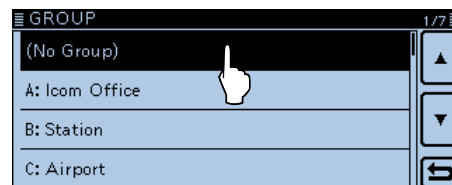

☞ Continued on the next page

Adding or editing GPS memory

◇ Add a GPS memory (Continued)

9. Writing the GPS memory

③③ Touch “<<Add Write>>.”

- If a previously added GPS memory was edited, touch “<<Overwrite>>.”

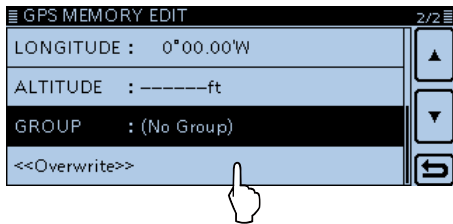

③④ Touch [YES].

- Writes the entered content into the GPS memory.
- The data is added to the GPS memory, and then the data screen is displayed.

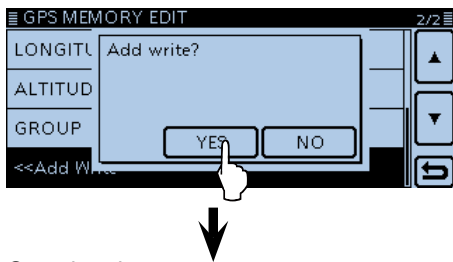

Completed

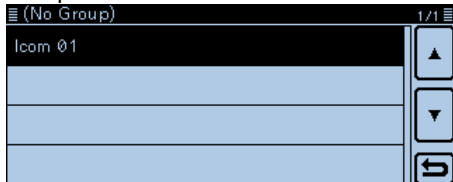

Example: When “Icom 01” is added into “(No group).”

To view the entered content:

To view the entered content, touch the desired GPS memory channel.

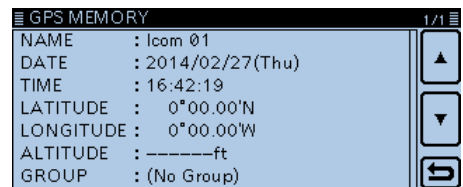

To cancel the entered data:

To cancel the entered data, touch [↵] to display the “Cancel edit?” screen.

Touch [YES] to cancel entering and the display returns to the GPS Memory group screen.

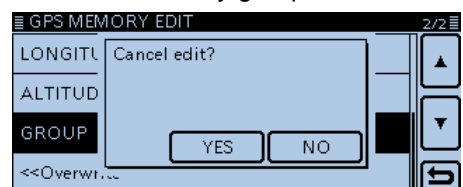

Adding or editing GPS memory (Continued)

◇ Entering the GPS group name

You can enter a name for each GPS group.

- ① Touch [MENU].
- ② Touch “GPS Message.”
(GPS > GPS Memory)
 - If the item is not displayed, touch [▲] or [▼] one or more times to select another page.

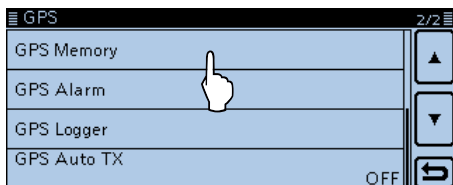

- ③ Touch the desired group for 1 second.

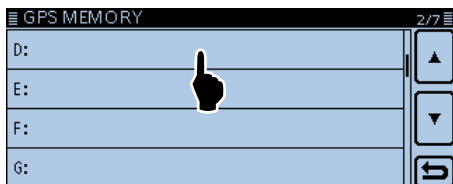

- ④ Touch “Edit Name.”
 - Opens the “GROUP NAME” screen.

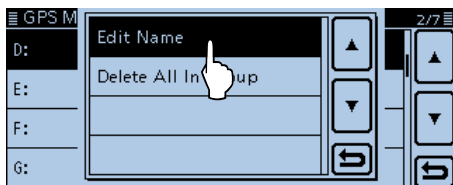

- ⑤ Touch the keypad.
 - Enters the desired character or symbol.
 - In the Alphabet entry mode, touch “↑” to enter an upper case letter once, or touch “↑↑” to continuously enter upper case letters. Touch “↓” to enter lower case letters.
 - Touch [[ab]] or [[12]], and then touch [ab], [12] or [(!#)] to select the desired entry mode.

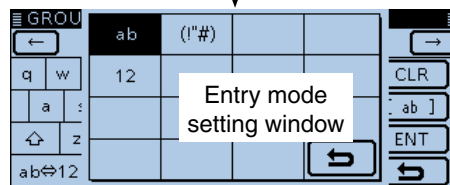
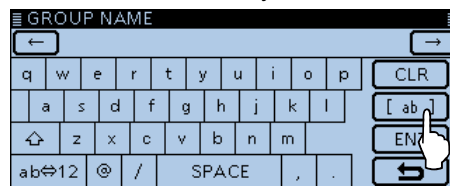

- Touch “ab⇌12” to toggle between the Alphabet entry and Number entry modes.
- Touch “SPACE” to enter a space.
- Touch [CLR] to delete the selected character, symbol or number.
- Touch [QUICK], and then touch “Switch to Tenkey” to switch the keyboard type.

Selectable characters and symbols
A to Z, a to z, 0 to 9, ! " # \$ % & ' () * + , - . / : ; < = > ? @ [\] ^ _ ` { } ~ (space)

- ⑥ Touch [←] to move the cursor backwards, or touch [→] to move the cursor forwards.
- ⑦ Repeat steps ⑦ and ⑧ to enter a GPS group name of up to 16 characters, including spaces.
- ⑧ After entering, touch [ENT].

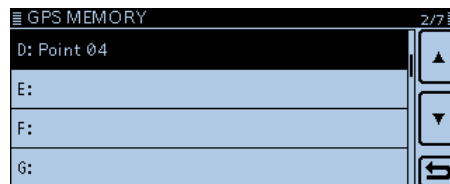

Example: Home area is entered

Adding or editing GPS memory (Continued)

◇ Clearing GPS data

GPS memories can be cleared (erased). Please note that erased GPS memories cannot be restored.

There are two ways to clear the memories:

- Erasing all GPS memory in a group.
- Erasing a specific memory channel.

Example: Erasing all in the “(No Group).”

① Touch [MENU].

② Touch “GPS Memory.”

(GPS > **GPS Memory**)

- If the item is not displayed, touch [▲] or [▼] one or more times to select another page.

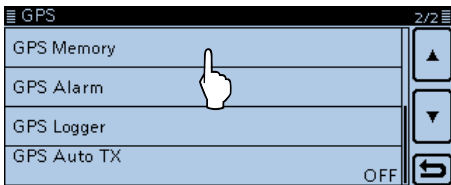

③ Touch the desired group for 1 second to delete.

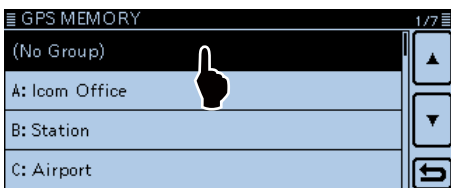

④ Touch “Delete All In Group.”

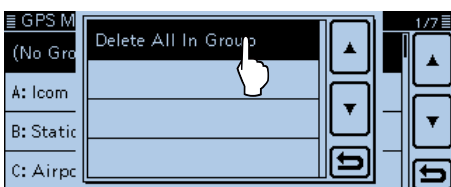

⑤ Touch [YES]

- All GPS memory in the selected group are cleared, and then screen returns to “GPS MEMORY.”

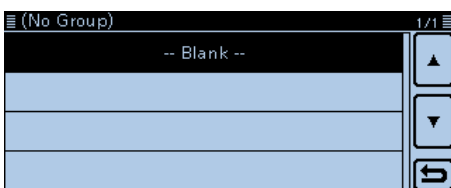
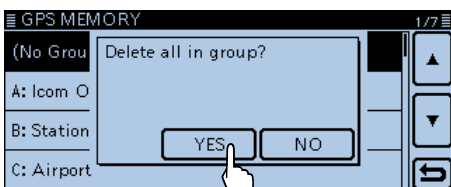

All GPS memory in the selected group are cleared. If you touch a blank group, “Blank” appears.

Deleting a specific GPS memory channel

You can delete a specific GPS memory.

① Touch the desired GPS memory for 1 second to delete.

② Touch “Delete.”

③ Touch [YES].

- The selected GPS memory channel is deleted.

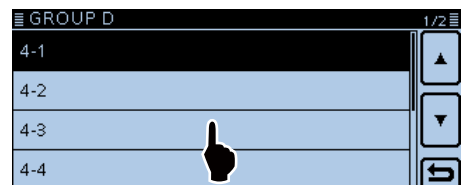

Touch the specific GPS memory for 1 second.

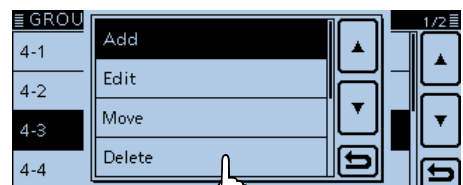

Touch “Delete.”

Adding or editing GPS memory (Continued)

◇ Rearranging the display order of the GPS data

You can move programmed GPS memories to rearrange their display order in the selected GPS memory group.

In order to move the GPS memory out of their assigned memory group, edit and move, and then save.

- ① Touch [MENU].
- ② Touch "GPS Memory."
(GPS > **GPS Memory**)
 - If the item is not displayed, touch [▲] or [▼] one or more times to select another page.

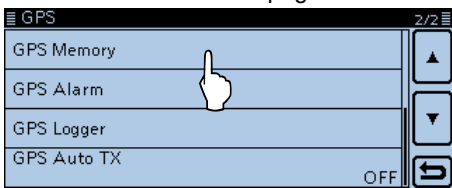

- ③ Touch the group where the desired GPS memory to move is stored.

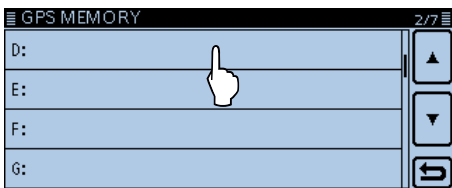

- ④ Touch the desired GPS memory for 1 second to move.

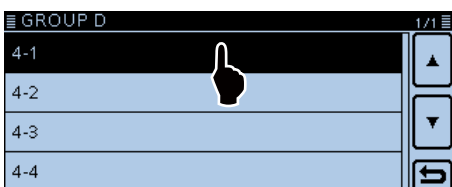

- ⑤ Touch "Move."
- "DESTINATION" blinks at the top left of the screen.

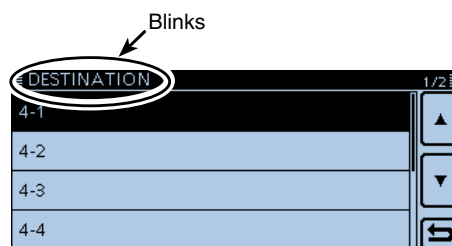
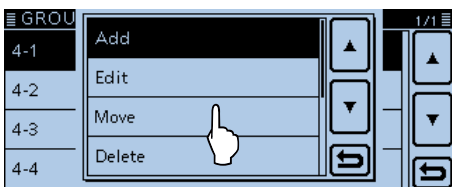

- ⑥ Touch the location to insert the memory you want to move.
 - The selected memory is moved up one position.
 - If "<<Move End>>" is touched, the desired memory is moved to the bottom of the group.
 - The selected memory is inserted above the destination memory name.
 - When "<<Move End>>" is selected, the selected memory is moved to the bottom of the memory group.

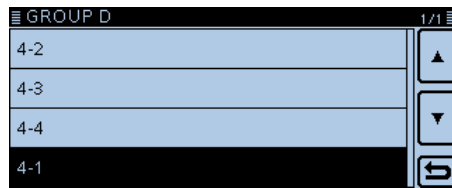
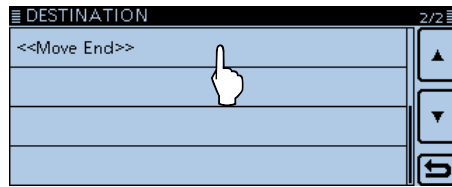

Completed

Adding or editing GPS memory (Continued)

◇ Setting the GPS alarm

A GPS alarm can sound when a target position comes into the alarm area.

This function can be set to the caller station, all GPS Memory channels, a specified Memory group or a specified Memory channel.

Alarm area 1 (Setting plural stations)

When all channels or group is selected:

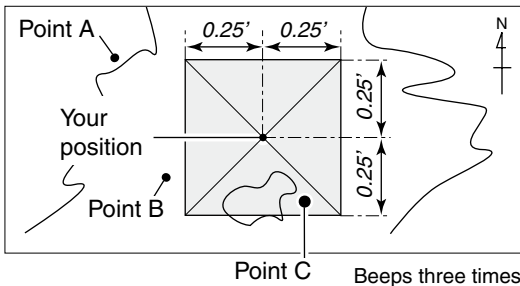

Alarm area 2 (Setting specific station)

When a specified memory is selected:

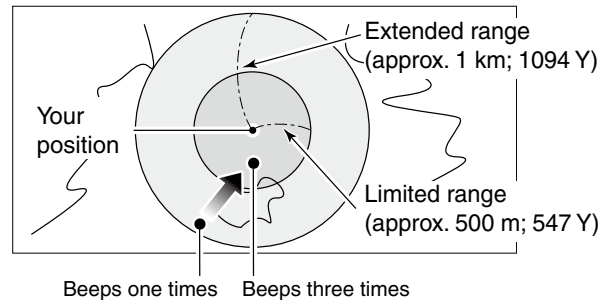

Example: Set the alarm setting to all GPS memory (All Memories).

- ① Touch [MENU].
- ② Touch "GPS Alarm."
(GPS > GPS Alarm)
 - If the item is not displayed, touch [▲] or [▼] one or more times to select another page.

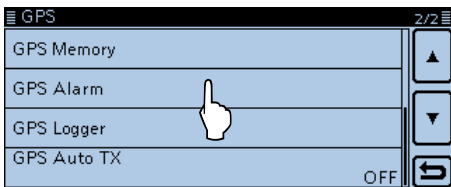

- ③ Touch "Alarm Select."

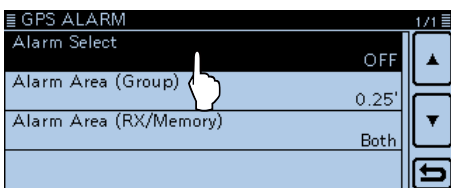

- ④ Touch "Group."

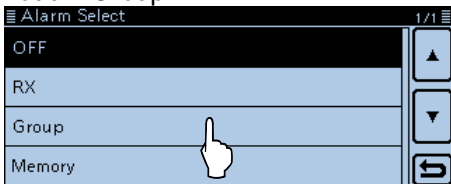

- ⑤ Touch "All Memories."
 - If you want to set the alarm to a GPS memory group, touch "(No Group)" or "A" to "Z."

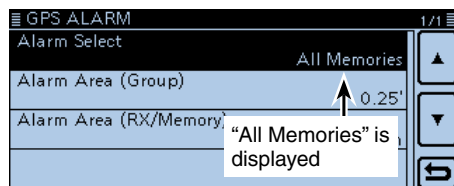
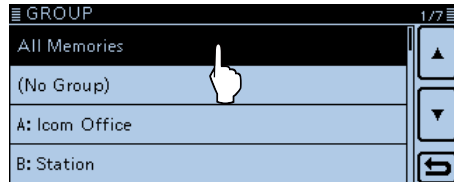

- ⑥ Touch [MENU].
 - Closes the Menu screen, and "•)" appears on the screen.
 - When either one of the stations in a specified group enters the set range, the beep sounds three times.
 - To cancel the GPS alarm, select "OFF" in the step ④.
 - When the GPS alarm sounds, "GPS ALARM" pops up on the screen and then "•)" blinks.

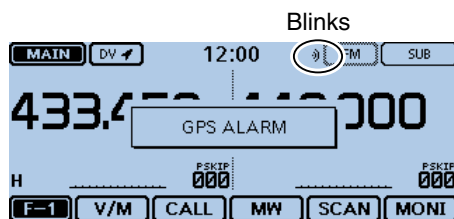

For your reference:
 When "All Memories", "A" to "Z" or "(No Group)" is selected, the alarm sounds depend on the "Alarm Area (Group)" setting in the Set mode.
 (GPS > GPS Alarm > **Alarm Area (Group)**)

Adding or editing GPS memory

◇ Setting the GPS alarm (Continued)

Example: Set the alarm setting to RX (RX/Memory).

① Touch [MENU].

② Touch “GPS Alarm.”

(GPS > GPS Alarm)

- If the item is not displayed, touch [▲] or [▼] one or more times to select another page.

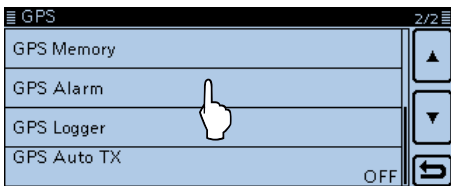

③ Touch “Alarm Select.”

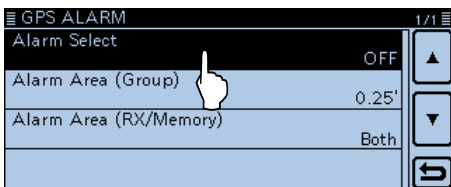

④ Touch “RX.”

- If you want to set the alarm to a GPS memory channel, touch “Memory,” and then touch “(No Group)” or “A” to “Z.”

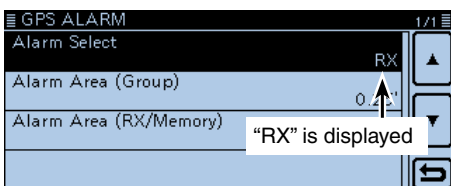
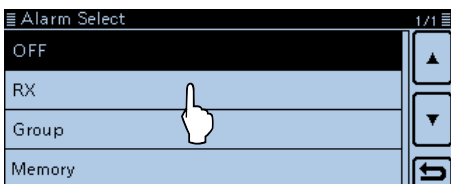

⑤ Touch [MENU].

- Closes the Menu screen, and “••)” appears on the screen.
- To cancel the GPS alarm, select “OFF” in the step ④.
- When a station with its GPS alarm set enters within an approximate 1 kilometer (1093 yard) range, the beep sounds once. When it enters within an approximate 500 meter (546 yard) range, a beep sounds three times.
- When the GPS alarm sounds, “GPS ALARM” pops up on the screen and then “••)” blinks.

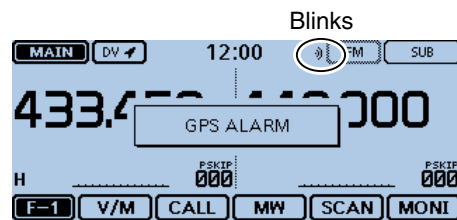

GPS alarm sounds, and “GPS ALARM” pops up.

For your reference:
When “RX” or a GPS memory channel is selected, the alarm sounds depending on the “Alarm Area (RX/Memory)” setting in the Menu screen.
(GPS > GPS Alarm > **Alarm Area (RX/Memory)**)

NOTE:
Even if “RX” is selected in step ④, and the received signal has no position, the GPS alarm does not sound.

GPS Logger function

The GPS Logger function allows you to store the positions from a GPS receiver into a SD card as a log. The GPS Logger stores Latitude, Longitude, Altitude, Positioning state, Course, Speed and Date. If you use this GPS Logger while driving, you can check your driving history on a mapping software.

◇ GPS Logger operating outline

To use GPS Logger function, perform following operations.

1. Insert a SD card.

(SD cards are not available from Icom. Purchase locally.)

2. Check whether or not the GPS receiver is receiving your position. (p. 8-2)

3. Turn ON the GPS Logger function.



Completed! The GPS Logger function starts.

◇ GPS Logger operation

Select whether or not store your route as a log. When the GPS Logger function is ON, the transceiver stores the position data from GPS receiver into SD card in a specified time interval. The stored GPS sentences are GGA, RMC, GSA and VTG.

① Touch [MENU].

② Touch "GPS Logger."

(GPS > GPS Logger)

- If the item is not displayed, touch [▲] or [▼] one or more times to select another page.

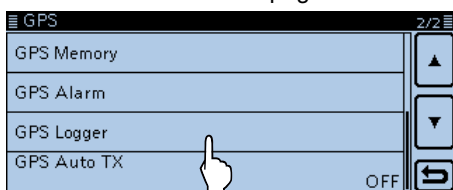

③ Touch "GPS Logger."

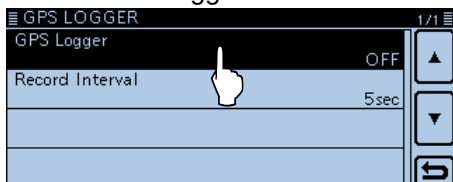

④ Touch "ON."

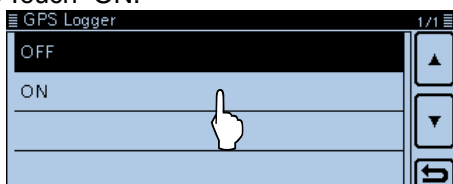

⑤ Touch [MENU].

- Closes the Menu screen, and the GPS Logger function starts.

NOTE:

- The GPS logger function requires an SD card.
- Once the GPS logger function is turned ON, the transceiver continuously stores the position data from the GPS receiver, even if the transceiver is rebooted. To cancel this function, turn OFF the function. While this function is ON, and when the transceiver is turned OFF, the log file will be closed. Then the transceiver is turned ON and Positioning is carried out by the GPS receiver, a new log file will be created.
- When the SD card is full, this function will be automatically paused.

◇ Setting the GPS record interval

For example, when you are walking and if the time interval is set to "1sec," a lot of position data is stored at almost same place. Select the GPS Logger function record interval to suit your travel speed. (Default: 5sec)

① Touch [MENU].

② Touch "Record Interval."

(GPS > GPS Logger > Record Interval)

- If the item is not displayed, touch [▲] or [▼] one or more times to select another page.

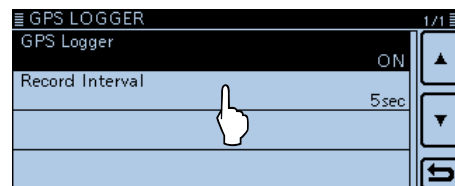

③ Touch a desired record interval.

- Selectable settings are 1, 5, 10, 30 or 60 seconds.

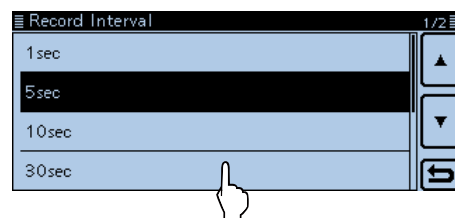

④ Touch [MENU].

- Closes the Menu screen.

GPS Logger function (Continued)

◇ Viewing the log data on a PC Map

If you want to display the your log data, copy the log file to your PC.

Windows 7 is used for these instructions.

- ① Turn OFF the power.
- ② Push in the SD card until a click sounds, and then carefully pull it out.

- **DO NOT** touch the terminals.
- To removing the card while the transceiver power is ON, unmount it first. (p. 9-5)

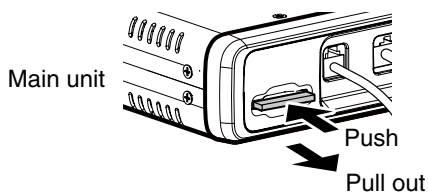

- ③ Insert the SD card into the SD card reader on your PC.

- If your PC does not have an SD card slot, connect an external memory card reader, and then insert the SD card into it.

- ④ Click the “Open folder to view files” option to access the card.

- Displays the ‘ID-5100’ folder.

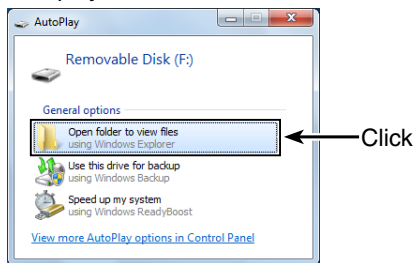

- ⑤ Double-click the folder.

- Eight folders appear.

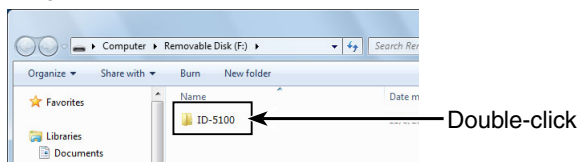

- ⑥ Double-click the “Gps” folder.

- The log files appear.
- The files are named with the time the log was started, in the following format:
 yyymmdd_hhmmss.log
 yyyy = year, mm = month, dd = day, hh = hour, mm = minute, ss = second

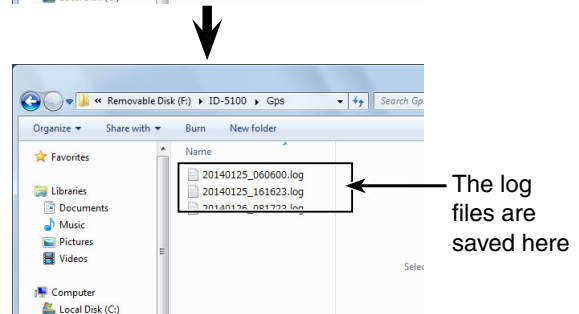
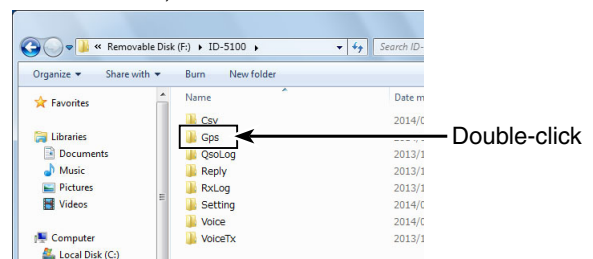

- ⑦ Import the selected file to a mapping software.

- You can see your route on the software map.
 The file may not be compatible with all mapping software.

GPS Logger function (Continued)

For your information— About the recorded NMEA sentence for GPS logging

Regarding the GPS logging data of the ID-5100A/E, each sentence corresponds to the NMEA standard and is recorded in the following format.

◇ GGA sentence

(e.g.) $\$GPGGA,161229.487,3723.2475,N,12158.3416,W,1,07,1.0,9.0,M,25.5,M,3.0000*18<CR><LF>$

- ① GGA protocol header (\$GPGGA)
 - ② UTC of position (16:12:29.487)
 - ③ Latitude (North 37° 23.2475') N=North, S=South
 - ④ Longitude (West 121° 58.3416') E=East, W=West
 - ⑤ GPS quality indicator (1)
0=Fix not available or invalid, 1=SPS mode
2=DGPS (SPS), 6=Estimated (Dead Reckoning) mode
 - ⑥ Number of satellites in use (7), 00–12
 - ⑦ Horizontal Dilution of Precision (1.0) 0.0–50.0
 - ⑧ Altitude re: mean-sea-level (geoid), meters (9.0 meters)
 - ⑨ Geoidal separation, meters (25.5 meters)
 - ⑩ Age of Differential GPS data (3 seconds)
 - ⑪ Check Sum (*18) Error detection data started with "*" (hex code)
 - ⑫ End code
- *Blank shows when not positioned.

◇ RMC sentence

(e.g.) $\$GPRMC,161229.487,A,3723.2475,N,12158.3416,W,0.13,309.62,011212,,D*10<CR><LF>$

- ① RMC protocol header (\$GPRMC)
 - ② UTC of position (16:12:29.487)
 - ③ Status (A) A=Data valid
V=Data invalid/not positioned
 - ④ Latitude (North 37° 23.2475') N=North, S=South
 - ⑤ Longitude (West 121° 58.3416') E=East, W=West
 - ⑥ Speed over ground (0.13 knots)
 - ⑦ Course Over Ground (309.62°; degrees True)
0.00°–359.99°
 - ⑧ UTC date of position ('12 Dec 1st) yymmdd
 - ⑨ Mode Indicator (D)
A=Autonomous mode, D=DGPS,
E=Estimated (dead reckoning) mode,
N=Data not valid, R=Almanac data
 - ⑩ Check Sum (*10) Error detection data started with "*" (hex code)
 - ⑪ End code
- *Blank shows when not positioned.

◇ GSA sentence

(e.g.) $\$GPGSA,A,3,07,02,26,27,09,04,,,,,15,1.8,1.0,1.5*33<CR><LF>$

- ① GSA protocol header (\$GPGSA)
 - ② Mode indicator 1 (A)
M=Manual, forced to operate in 2D or 3D mode
A=Automatic, allowed to automatically switch 2D/3D
 - ③ Mode indicator 2 (3)
1=Fix not available,
2=2D (using satellites; less than 3),
3=3D (using satellites; more than 4)
 - ④ ID numbers of satellites used in solution (07, 02, 26, 27, 09, 04...15)
01–32 *Shows up to 12 ID's
 - ⑤ Position Dilution of Precision (1.8) 0.0–50.0
 - ⑥ Horizontal Dilution of Precision (1.0) 0.0–50.0
 - ⑦ Vertical Dilution of Position (1.5) 0.0–50.0
 - ⑧ Check Sum (*33) Error detection data started with "*" (hex code)
 - ⑨ End code
- *Blank shows when not positioned.

◇ VTG sentence

(e.g.) $\$GPVTG,309.62,T,,M,0.13,N,0.2,K,A*03<CR><LF>$

- ① VTG protocol header (\$GPVTG)
 - ② Course Over Ground (309.62°; degrees True)
0.00°–359.99°
 - ③ Course over ground degrees; Magnetic north
 - ④ Speed over ground, knots (0.13 knots)
 - ⑤ Speed over ground, kilometer per hour (0.2 km/hr)
 - ⑥ Mode Indicator (A)
A=Autonomous mode, D=DGPS,
E=Estimated (dead reckoning) mode,
N=Data not valid, R=Almanac data
 - ⑦ Check Sum (*03) Error detection data started with "*" (hex code)
 - ⑧ End code
- *Blank shows when not positioned.

GPS Auto transmission for only Simplex

In the DV mode, this function automatically transmits the GPS receiver's current position data at a selected interval, and should only be used in the simplex mode.

- Your own call sign must be entered to activate the GPS automatic transmission.
 - When the "GPS TX Mode" item is set to "NMEA," be sure to set the "GPS Select" item to "Internal GPS."
 - When the "GPS TX Mode" item is set to "D-PRS," and the "TX Format" item is set to "Position" or "Weather," be sure to set the "GPS Select" item to "Internal GPS" or "Manual." (p. 12-20)
- Otherwise, you cannot use this function.
(GPS > GPS Set > **GPS Select**)

◇ Setting the GPS automatic transmission

- ① Touch [MENU].
- ② Touch "GPS Auto TX."
(GPS > **GPS Auto TX**)
 - If the item is not displayed, touch [▲] or [▼] one or more times to select another page.

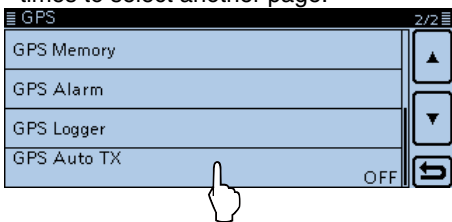

- ③ Touch to select the desired position transmit interval between OFF, 5, 10, 30 seconds, or 1, 3, 5, 10, and 30 minutes.
 - Selecting "OFF" cancels the GPS automatic transmission.
 - If four GPS sentences are selected in the "GPS Sentence" item, "5sec" cannot be selected.
 - The GPS message is also transmitted, if programmed.

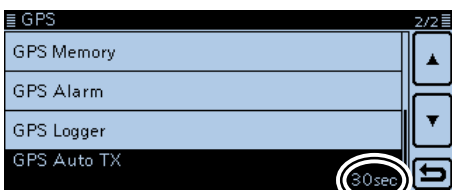
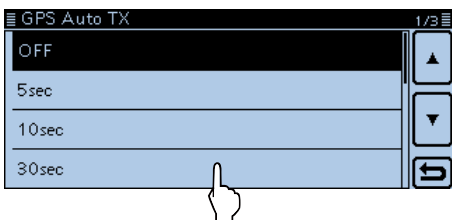

"30sec" is displayed

- ④ Touch [MENU].
 - Closes the Menu screen.

NOTE:

- Use GPS automatic transmission in only the simplex mode.
- GPS automatic transmission through a repeater may interfere with other communications. When a GPS message is programmed, the transceiver transmits it along with the position data. See page 8-28 for the GPS message programming.

About the SD card	9-2
Saving data onto the SD card.....	9-3
Inserting the SD card	9-4
◇ Inserting the SD card	9-4
◇ Formatting the SD card	9-4
Removing the SD card	9-5
◇ Removing the SD card	9-5
◇ Removing the SD card while the transceiver's power is ON ...	9-5
Saving the setting data onto an SD card.....	9-6
Saving with a different file name.....	9-7
Loading the saved data files that are on the SD card	9-8
Backing up the data stored on the SD card onto a PC	9-9
◇ About the SD card's folder contents	9-9
◇ Making a backup file on your PC.....	9-10
Importing or Exporting a CSV format file.....	9-11
◇ Importing	9-11
◇ Exporting	9-12

About the SD card

The SD and SDHC cards are not available from Icom. Purchase separately.

An SD card of up to 2 GB, or an SDHC of up to 32 GB, can be used with the ID-5100A/E. Icom has checked the compatibility with the following SD and SDHC cards.

(As of March 2014)

Brand	Type	Memory size
SanDisk®	SD	2 GB
	SDHC	4 GB
		8 GB
		16 GB
		32 GB

- The above list does not guarantee the card's performance.
- Throughout the rest of this document, the SD card and an SDHC card are simply called SD cards.
- Icom recommends that you format all SD cards to be used with the transceiver, even preformatted SD cards for PCs or other uses.

- ▨ Saving the factory default data is recommended.
 - ➔ Insert the card into the transceiver's slot, and then touch [MENU]. Touch "SD Card," and then "Save Setting" to save.

NOTE:

- Before using the SD card, read the instructions of the SD card thoroughly.
- If you do any of the following, the SD card data may be corrupted or deleted.
 - You remove the SD card from the transceiver while accessing the SD card.
 - You change the external power supply's voltage while accessing the SD card.
 - You start the vehicle engine while accessing the SD card.
 - You drop, impact or vibrate the SD card.
- Do not touch the contacts of the SD card.
- The transceiver takes a longer time to recognize a high capacity SD card.
- The SD card will get warm if used continuously for a long period of time.
- The SD card has a certain lifetime, so data reading or writing may not be possible after using it for a long time period.
- When reading or writing data is impossible, the SD card's lifetime has ended. In this case, purchase a new one. We recommend you make a backup file of the important data onto your PC.
- Icom will not be responsible for any damage caused by data corruption of an SD card.

Saving data onto the SD card

The following data can be stored onto the card:

- **Data settings of the transceiver**

Memory channel contents, repeater lists, Your (UR) memory and GPS memory that are stored in the transceiver.

- **Communication contents**

The transmitted and received audio.

- **Communication log**

The communication and receive logs.

- **Automatic answering voice audio for the DV mode**

Voice audio used for the Auto Reply function in the DV mode.

- **Voice audio for the Voice TX function**

Voice audio used for the Voice TX function.

- **GPS position data**

The GPS position data is stored as tracking data.

Inserting the SD card

◇ Inserting the SD card

- ① Turn OFF the transceiver.
- ② Insert the card into the slot until it locks in place, and makes a 'click' sound.
- ③ Turn ON the transceiver.
 - "SD" is displayed when the SD card is inserted.
 - "SD" and "FM" alternately blink while accessing the SD card.

NOTE: Before inserting, be sure to check the card direction. If the card is forcibly or inversely inserted, it will damage the card and/or the slot.

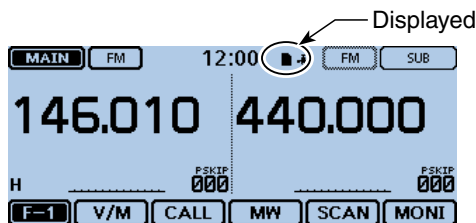
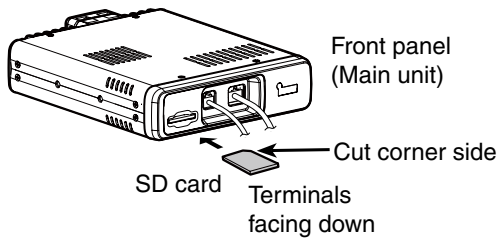

◇ Formatting the SD card

- If you use a brand new SD card, format it by doing the following steps.
- **Formatting a card erases all its data.** Before formatting any used card, back up its data onto your PC.

- ① Turn OFF the transceiver, and then insert the card into the slot.
- ② Turn ON the transceiver.
 - "SD" appears when the SD card is inserted.

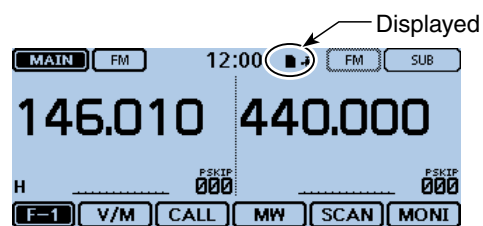

- ③ Touch [MENU].
- ④ Touch "SD Card."
 - If the item is not displayed, touch [▲] or [▼] one or more times to select the page.

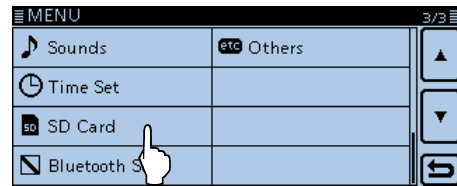

- ⑤ Touch "Format."
 - The confirmation window "Format OK?" appears.



- ⑥ Touch [YES].
 - The formatting starts and the display shows the formatting progress.
 - After formatting ends, the display automatically returns to the screen displayed before the "Format OK?" window.

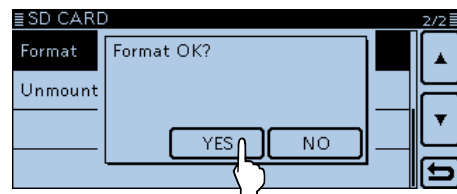

Removing the SD card

◇ Removing the SD card

- ① Turn OFF the power.
- ② Push in the SD card until a click sounds, and then carefully pull it out.

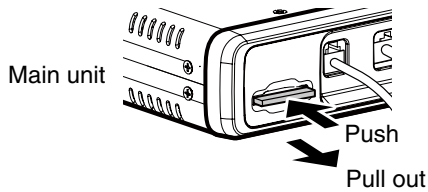

◇ Removing the SD card while the transceiver's power is ON

- ① Touch [MENU].
- ② Touch "SD Card."
 - If the item is not displayed, touch [▲] or [▼] one or more times to select the page.

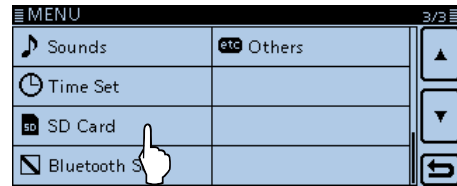

- ③ Touch "Unmount."
 - The confirmation window "Unmount OK?" appears.

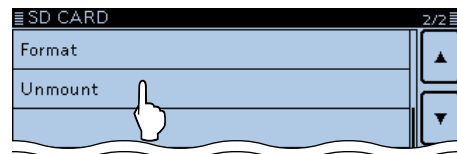

- ④ Touch [YES].
 - When the unmounting is completed, "Unmount is completed." is displayed, then the display automatically returns to the screen displayed before the "Unmount OK?" window.

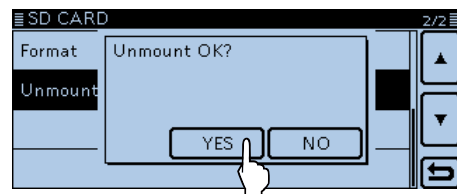

- ⑤ Push in the SD card until a click sounds, and then carefully pull it out.

Saving the setting data onto an SD card

Memory channels, Menu screen item settings, and repeater lists can be saved on an SD card. Saving data settings on an SD card allows you to easily restore the transceiver to its previous settings, even if an All reset is performed.

✓ For your information

Data settings are saved in the “icf” file format that is used in the CS-5100 cloning software. The saved data on an SD card can be copied to a PC and edited with the cloning software.

Data settings can be saved as a new file or to overwrite an older file.

[Saved as a new file]

- ① Touch [MENU].
- ② Touch “Save Setting.”
(SD Card > **Save Setting**)
 - Opens the SAVE SETTING screen.
 - If the item is not displayed, touch [▲] or [▼] one or more times to select the page.

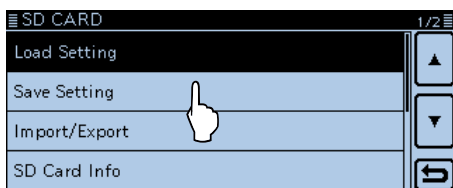

- ③ Touch “<<New File>>.”
 - Opens the FILE NAME screen.
 - The file name is automatically named in the following manner; Setyyyyymmdd_xx (yyyy: Year, mm: month, dd: day, xx: serial number)
Example: If a second file is saved on April 1, 2014, the file is named “Set20140401_02.”
 - If you want to change the file name, see “Save with a different file name” (p. 9-7).

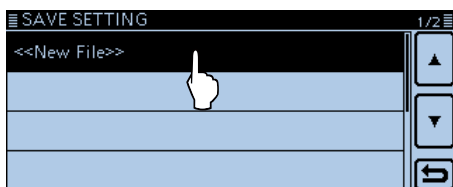

- ④ Touch [ENT].
 - Opens the confirmation window “Save file?.”

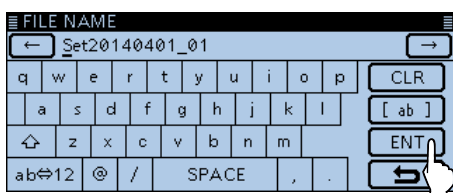

- ⑤ Touch [YES].
 - Saves the data settings.
 - While saving, a progress bar is displayed, then the SD CARD screen is displayed after the save is completed.

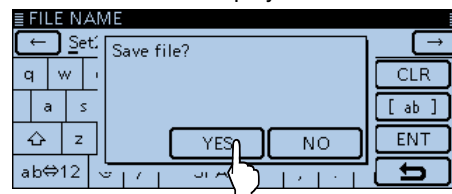

- ⑥ Touch [MENU]
 - Cancels the Menu screen.

[Overwriting a file]

- Select the desired file to be overwritten in step ③ to the left.

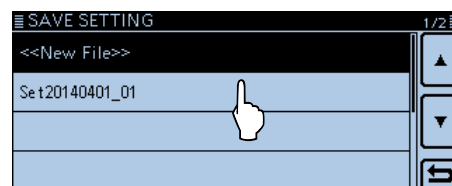

Saving with a different file name

- ① Touch [MENU].
- ② Touch "Save Setting."
(SD Card > **Save Setting**)
 - Opens the SAVE SETTING screen.
 - If the item is not displayed, touch [▲] or [▼] one or more times to select the page.

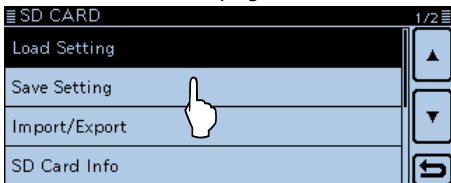

- ③ Touch "<<New File>>".
 - Opens the FILE NAME screen.

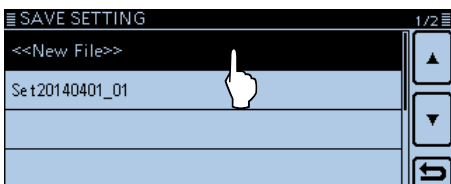

- ④ Touch [CLR].
 - Deletes the selected character, symbol or number.
 - When the cursor does not select a character, the previous character is deleted.
 - If [CLR] is touched and held, the characters are continuously deleted.

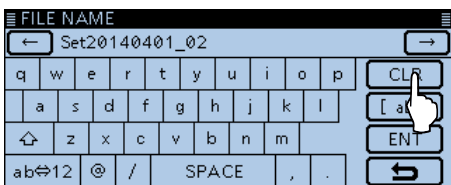

- ⑤ Touch the keypad.
 - Enters the desired character or symbol.
 - In the Alphabet entry mode, touch "⇧" to enter an upper case letter once, or touch "⇧" to continuously enter upper case letters. Touch "⇩" to enter lower case letters.
 - Touch [[ab]] or [[12]], and then touch [ab], [12] or [(!#)] to select the desired entry mode.

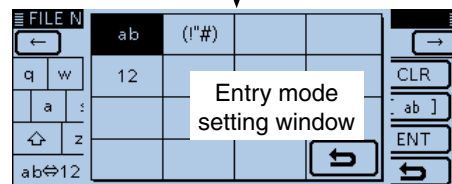
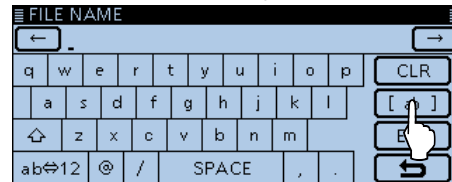

- Touch "AB⇔12" to toggle between the Alphabet entry and Number entry modes.
- Touch "SPACE" to enter a space.
- Touch [CLR] to delete the selected character, symbol or number.
- Touch [QUICK], and then touch "Switch to Tenkey" to switch the keyboard type.

Selectable characters and symbols
A to Z, a to z, 0 to 9, ! " # \$ % & ' () * + , - . / : ; < = > ? @ [\] ^ _ ` { } ~ (space)

- ⑥ Touch [←] to move the cursor backwards, or touch [→] to move the cursor forwards.
- ⑦ Repeat steps ⑤ and ⑥ to enter a name of up to 10 characters. (Example: My data)
- ⑧ Touch [ENT] to save the name.
 - The confirmation window "Save file?" appears.

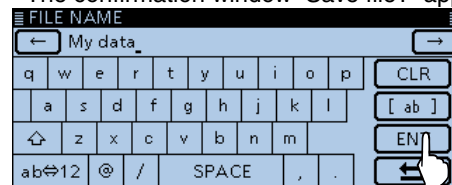

- ⑨ Touch [YES].
 - Saves the setting data.
 - While saving, a progress bar is displayed, then the SD CARD screen is displayed after the save is completed.

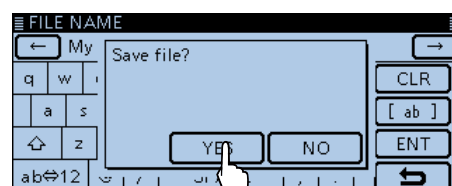

- ⑩ Touch [MENU]
 - Closes the Menu screen.

Loading the saved data files that are on the SD card

Memory channels, Menu screen item settings, and repeater lists can be copied to the transceiver. This function is convenient when copying the saved data, such as memory channels, or repeater lists, to another ID-5100, and then operating with the same data.

Saving the current data is recommended before loading other data into the transceiver.

(Example: Loading all the data into the "Set20140401_01" file)

- ① Touch [MENU].
- ② Touch "Load Setting."
(SD Card > **Load Setting**)
 - Opens the LOAD SETTING screen.
 - If the item is not displayed, touch [▲] or [▼] one or more times to select the page.

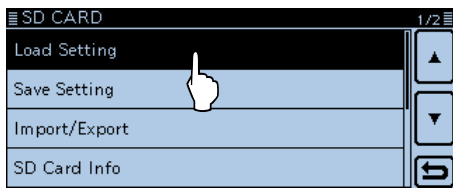

- ③ Touch the desired file to be loaded.
 - The LOAD FILE screen appears.

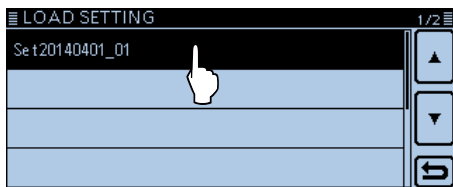

- ④ Touch the desired loading option.
 - ALL: Loads all memory channels, Menu screen item settings and the repeater list into the transceiver.
 - Except My Station: Loads all memory channels, Menu screen item settings and the repeater list except MY call signs and TX message into the transceiver.
 - Repeater List Only: Loads only the repeater list into the transceiver.

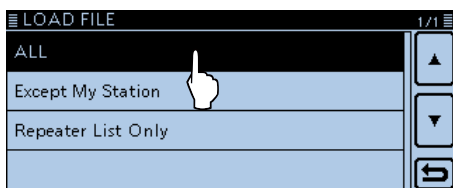

To update the repeater list, click here!



- ⑤ The "Keep 'SKIP' settings in the Repeater List?" appears. Touch [YES], [NO] or [Cancel].
 - Touching [YES] retains the skip settings of the repeater list. (p. 7-29)
 - Touching [NO] does not retain the skip settings of the repeater list.
 - Touching [Cancel] returns to the LOAD FILE screen.
 - When you touch [YES] or [NO], "Load file?" is displayed.

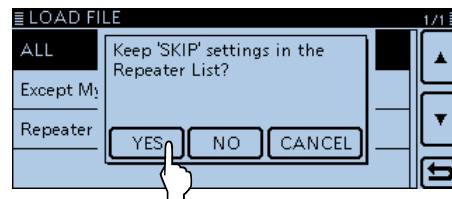

- ⑥ Touch [YES]
 - Starts the file check.
 - While checking the file, displays "CHECKING FILE" and a progress bar.
- ⑦ After checking, settings data loading begins.
 - While loading, "LOADING" and a progress bar are displayed.

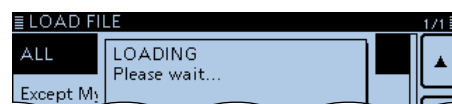
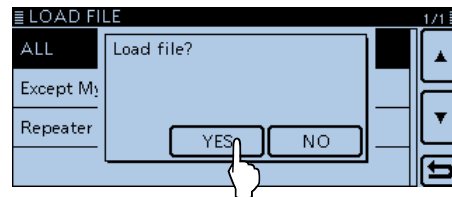

- ⑧ After loading ends, "COMPLETED!" is displayed. To complete the loading, reboot the transceiver.

Backing up the data stored on the SD card onto a PC

A backup file allows easy restoration, even if the data on the SD card is accidentally deleted.

If your PC does not have an SD card slot, connect an external memory card reader to use the SD card.

◆ About the SD card's folder contents

The folder in the SD card contains the following:

- ① ID-5100 folder
Contains the folders created in the ID-5100.
- ② Csv folder
Contains the GPS Memory, Repeater List and Your Call Sign Memory folders.
- ③ GpsMemory folder
Stores the Gps Memory in the "csv" format to import.
- ④ RptList folder
Stores the Repeater List in the "csv" format to import.
- ⑤ YourMemory folder
Stores the Your Call Sign Memory in the "csv" format to import.
- ⑥ Gps folder
Stores GPS logging data in the "log" format.
- ⑦ QSOLog folder
Stores QSO log data in the "csv" format.
- ⑧ Reply folder
Stores Automatic reply data in the "wav" format.
- ⑨ RxLog folder
Stores RX record log data in the "csv" format.
- ⑩ Setting folder
Stores the transceiver's setting data in the "icf" format.
- ⑪ Voice folder
Creates the recorded QSO audio date folders.
- ⑫ yyyyymmdd folder
Stores the recorded audio file in the "wav" format.
The folder name is automatically created in the following format:
yyyyymmdd (yyyy:Year, mm:month, dd:day)
- ⑬ VoiceTx folder
Stores the recorded voice audio data for the Voice TX function in the "wav" format.

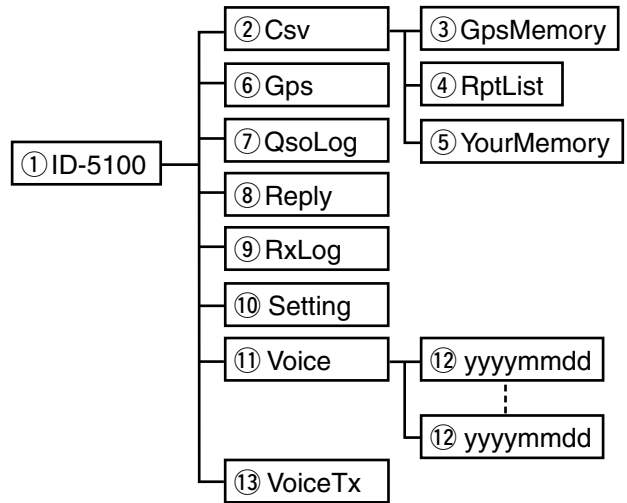

(Example: Selecting the setting data)

When the SD card is inserted into the SD card slot of your PC or the SD card reader, the screen appears as shown below.

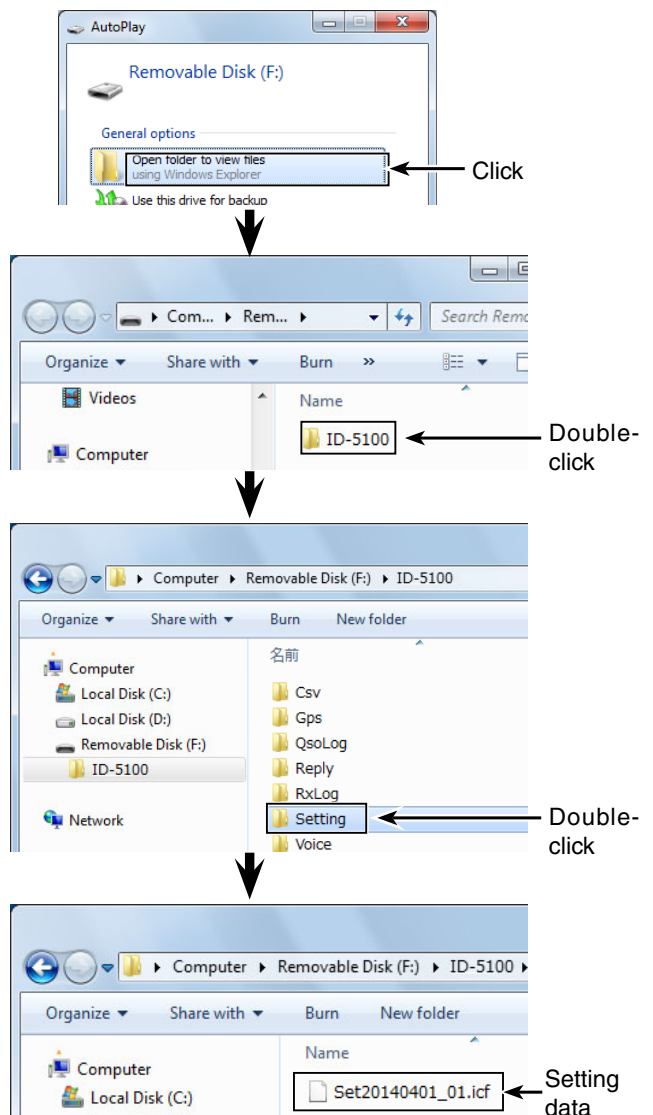

Backing up the data stored on the SD card onto a PC (Continued)

◆ **Making a backup file on your PC**

Windows 7 is used for these instructions.

- ① Insert the SD card into the SD card reader on your PC.
 - If your PC does not have an SD card slot, connect an external memory card reader, and then insert the SD card into it.
- ② Click the “Open folder to view files” option to access the card.
 - Displays the ‘ID-5100’ folder.

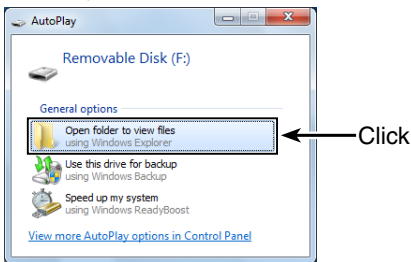

- ③ Right-click “Removable disk.”
- ④ Click “Copy.”

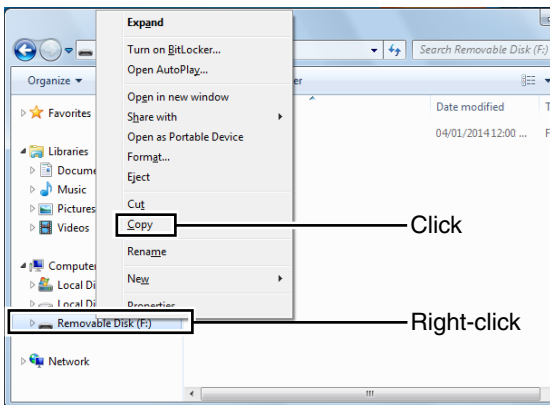

- ⑤ Open the desired folder to copy to, then right-click, and then click “Paste.”
 - Copies the SD card data onto your hard disk.
- (Example: Copying the “Backup” folder on C drive)

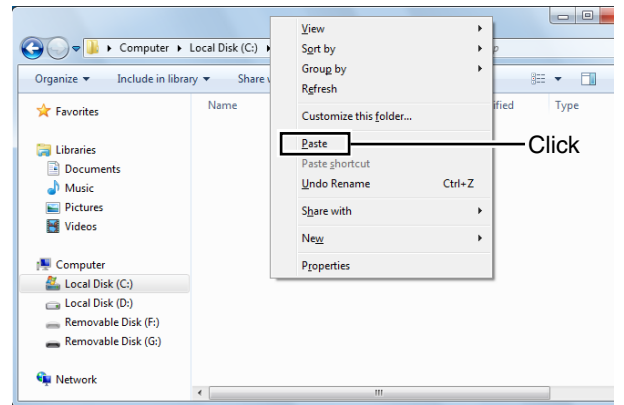

- ⑥ When removing the SD card, click the SD card icon in the task bar. (The “Eject” icon in the screen shot as shown to the right.)

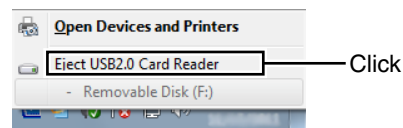

When a memory card reader is connected.

- ⑦ Remove the SD card when “Safe To Remove Hardware” is displayed.

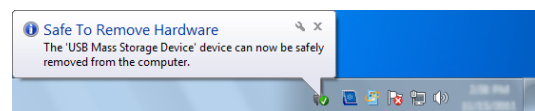

When a memory card reader is used.

Importing or Exporting a CSV format file

Please read this section before importing or exporting a Comma Separated Values (CSV) format file from the SD card.

You can import or export the following data:

- Your Call Sign Memory
- Repeater List
- GPS Memory

◇ Importing

Before importing, make a backup file of all the transceiver's data to the SD card in case of data loss.

Example: Importing the Your Call sign memory.

- ① Touch [MENU].
- ② Touch "Your Call Sign."
(SD Card > Import/Export > Import > **Your Call Sign**)
 - If the item is not displayed, touch [▲] or [▼] one or more times to select the page.

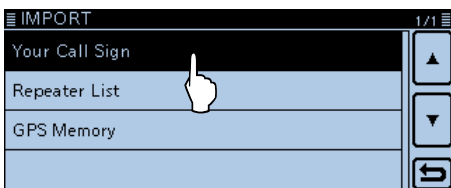

- ③ Touch the CSV file to import.
 - Opens the "Import file?" window.

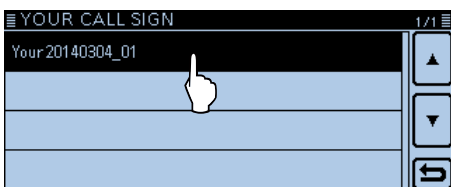

- ④ Touch [YES].
 - Starts to import.
 - While importing, "IMPORTING" and a progress bar are displayed.
 - After importing ends, "COMPLETED!" appears.

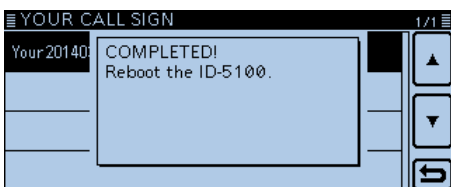
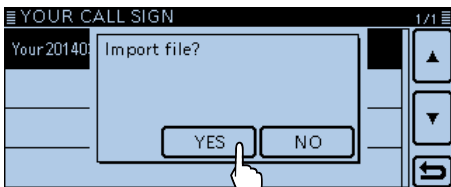

- ⑤ To complete the importing, reboot the transceiver.

To import a repeater list, see the step ⑤ on page 9-8 for details.

Importing or Exporting a CSV format file (Continued)

◇ Exporting

You can export Your Call Sign Memory, Repeater List and GPS Memory.

Example: Exporting the Your Call sign memory.

- ① Touch [MENU].
- ② Touch “Your Call Sign.”
(SD Card > Import/Export > Export > **Your Call Sign**)
- If the item is not displayed, touch [▲] or [▼] one or more times to select the page.

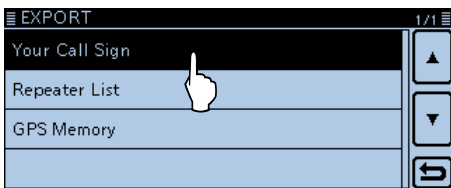

- ③ Touch “<<New File>>.”
- Opens the FILE NAME screen.
- The file name is automatically named in the following manner; Your*yyyymmdd_xx (yyyy: Year, mm: month, dd: day, xx: serial number)
- *‘Rpt’ is displayed for a repeater list, and ‘Gps’ is displayed for a GPS memory.
- If you want to change the file name, see “Save with a different file name” (p. 9-7).

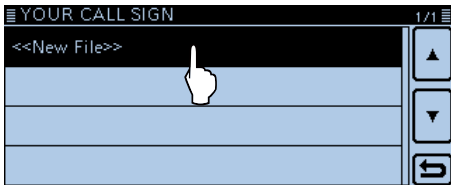

- ④ Touch [ENT].
- Opens the “Export file?” window.

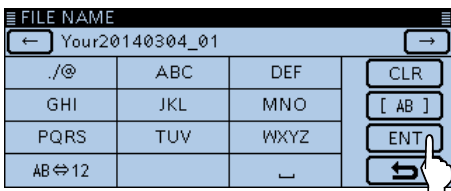

- ⑤ Touch [YES].
- Saves the data settings.
- While exporting, “EXPORTING” and a progress bar are displayed.

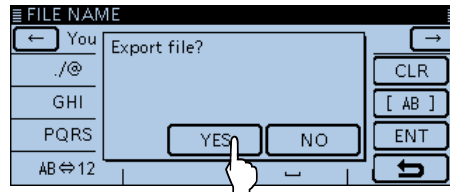

- ⑥ Touch [MENU]
- Cancels the Menu screen.

[Overwriting a file]

- ➔ Select the desired file to be overwritten in step ③ to the left.

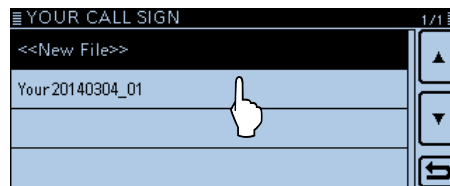

Section 10 VOICE MEMORY

Recording a QSO audio	10-2
◇ To starting to record	10-2
◇ To stop recording.....	10-2
Playing back the recorded audio	10-3
◇ Playing back the recording	10-3
Changing the QSO recorder settings	10-4
Deleting the audio folder/file	10-5
◇ Delete an Audio Folder.....	10-5
◇ Delete an Audio File	10-6
Viewing the file information.....	10-7
Viewing the SD card memory capacity.....	10-8
Playing back the recorded audio on the PC.....	10-9

Recording a QSO audio

Recording a QSO audio using the MAIN band.

NOTE:

Be sure to insert an SD card into the transceiver before recording the audio.

◇ **To starting to record**

- ① Touch [QUICK].
- ② Touch “<<REC Start>>”
 - Enters to the Recording Standby mode.

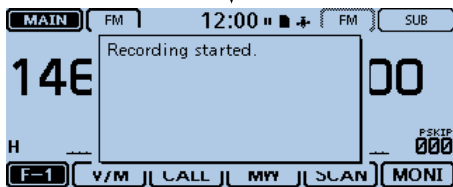
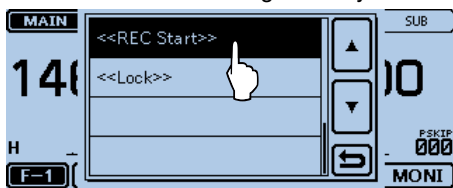

Appears

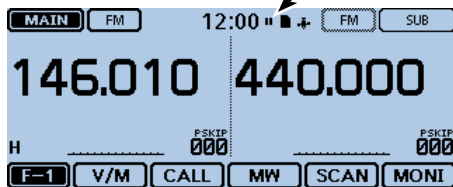

Standby mode



Starts to record when the squelch opens.

Appears Blinks

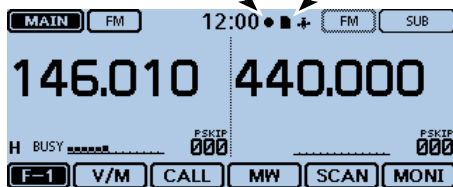

Recording

- Recording pauses while no signal is received, and resumes when a signal is received again.
- Recording continues until you manually stop recording, or the card becomes full.
- If the recording file's content reaches 2GB, the transceiver automatically creates a new file, and continues recording.

For your reference:

When the PTT Automatic Recording function is set to ON, the recording automatically starts when “<<REC Start>>” is touched. (In this case, recording continues even while no signal is received.) See page 12-17 for the setting details.

◇ **To stop recording**

- ① Touch [QUICK].
- ② Touch “<<REC Stop>>”
 - The transceiver displays “Recording stopped,” and automatically exits the Quick Menu screen.

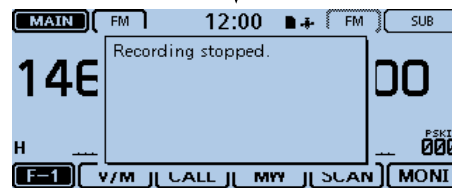
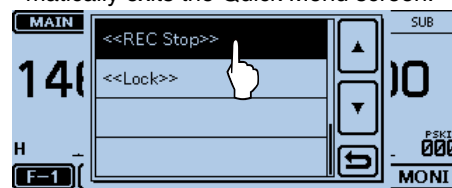

For your reference:

When touching either the “●” or “||” icons, the “Stop recording?” dialog box appears. Touching [YES] also stops the recording.

NOTE:

Once the recording has started, it will continue, even if the transceiver is rebooted.

Playing back the recorded audio

NOTE:

Insert the SD card, which contains the recorded audio file, into the transceiver's slot.

◇ Playing back the recording

- ① Touch [MENU].
 - Opens the Menu screen.
- ② Touch "Voice Memo."

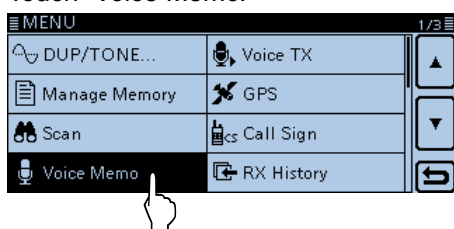

- ③ Touch "QSO Recorder."

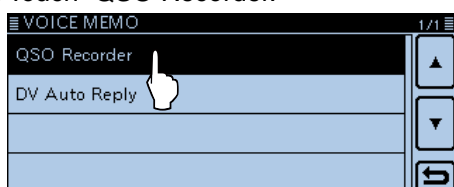

- ④ Touch "Play Files."

 - The recorded file folders appear.

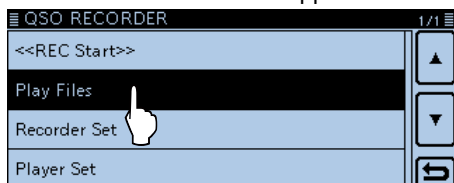

- ⑤ Touch the folder that contains the audio file to play.
 - The folder name is automatically named in the following manner: yyyyymmdd (yyyy: Year, mm: month, dd: day)

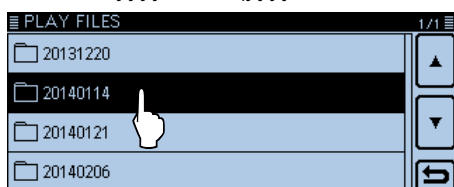

- ⑥ Touch the audio file to play.
 - The VOICE PLAYER screen is displayed, and the file starts to play.

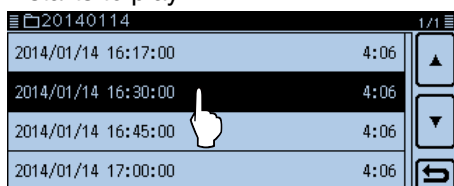

- The file name is automatically named in the following manner: yyyyymmdd_x (yyyy: Year, mm: month, dd: day, hh: hour, mm: minute, ss: second)

- ⑦ Listen to the QSO audio.

• The Voice Player screen description

Recording information
Shows the operating frequency, and operating mode and audio category.
• While the receive audio is playing back, "RX" is displayed. While the transmit audio is playing back, "TX" is displayed.

File numbers
Shows the current playback file and the total number of files in the folder.

Recorded date
Shows the recorded date and time.

Played back time / Total time
Shows the played back time / file's total playback time.

Navigation:
 ◀◀ Play the previous file
 ◀◀ Pause or play
 ▶▶ Play the next file

For your reference:

Fast forward/Rewind

- Touch and hold **▶▶** / **◀◀** for 1 second to continuously fast forward/rewind the file.
- The default skip time is 10 seconds. If you want to change it, see "Changing the skip time." (p. 10-4)
- You can fast forward or rewind the file that is playing by rotating [DIAL]. The fast forward/rewind time is 1/20 of the total file time, regardless of the skip time setting.

Rewind while playing

- If you touch **◀◀** within the first one second of the file, the skip time at the end of the previously recorded file will playback.

Playing the previous file

- While the oldest file in the folder is playing back, touch **◀◀** to start playing the file at the beginning.
- When the playback is paused at the beginning of a file, touch **◀◀** to move to the beginning of the previous file, and pause.

Playing the next file

- While the latest file in the folder is playing back, touch **▶▶** to stop playing.
- When the playback is paused, touch **▶▶** to move to the beginning of the next file, and pause.

Operating information

- The operating frequency, mode, and audio category (received audio or transmitted audio) is also recorded as the operating information.

Changing the QSO recorder settings

You can change the recording setting on the Menu screen.

See “Voice Memo” item in the Menu screen (p. 12-17) for the setting details.

- Records only the received audio. (“**REC Mode**”) (Voice Memo > QSO Recorder > Recorder Set)

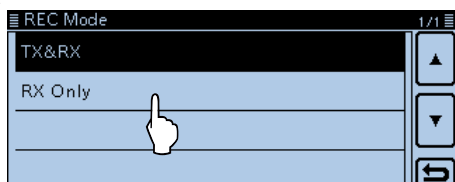

▨ The default setting is “TX&RX” (Both transmitted and received audio are recorded).

- Continues to record even while the squelch is closed. (“**RX REC Condition**”) (Voice Memo > QSO Recorder > Recorder Set)

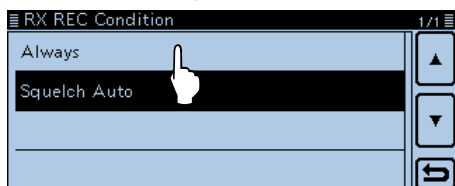

▨ The default setting is “Squelch Auto” (Records only while the squelch is open.).

- Records the QSO audio as one file. (“**File Split**”) (Voice Memo > QSO Recorder > Recorder Set)



- ▨ The default setting is “File Split” (transmitted and received audio are separately recorded in different files.).
- ▨ When “Squelch Auto” is selected in “Recorder Set,” an audio file is created every time the squelch opens. The received audio is recorded in a separated file.

- Synchronize the recording to PTT. (“**PTT Auto REC**”) (Voice Memo > QSO Recorder > Recorder Set)

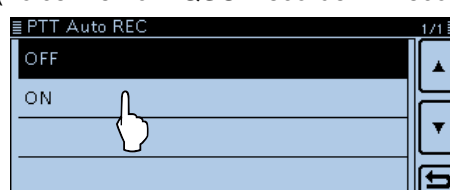

▨ The default setting is “OFF” (Recording is not synchronized to PTT.).

For your reference:

When “PTT Auto REC” is set to “ON”:

- Starts recording not only when PTT is pushed, but also when switched to transmit by the CI-V command.
- When the “RX Only” is selected in “REC Mode,” the transmit audio is not recorded.
- A signal that is received within 10 seconds after the squelch is closed is recorded in same file.

- Change the Skip Time. (“**Skip Time**”) (Voice Memo > QSO Recorder > Player Set)

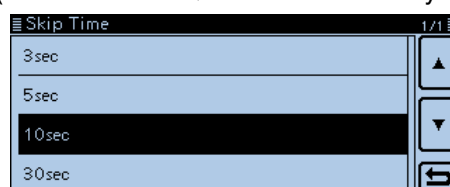

▨ The default setting is “10sec.”

Deleting the audio folder/file

⚡ A deleted audio file can NOT be recovered.

◆ Delete an Audio Folder

⚡ All audio files in the folder are deleted.

- ① Touch [MENU].
 - Opens the Menu screen.
- ② Touch “Voice Memo.”

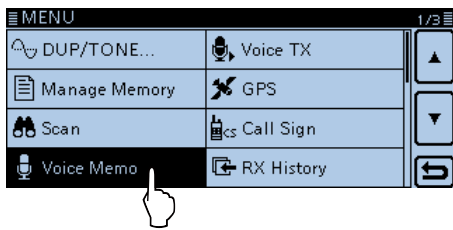

- ③ Touch “QSO Recorder.”

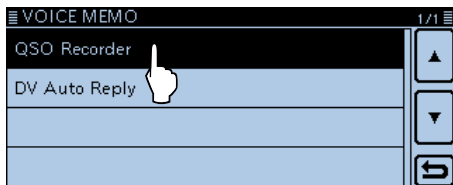

- ④ Touch “Play Files.”
 - The recorded file folders appear.

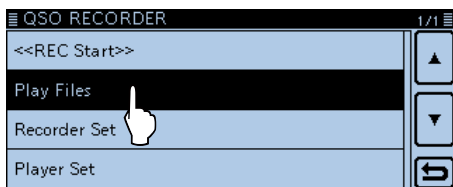

- ⑤ Touch and hold the folder to delete, for 1 second.

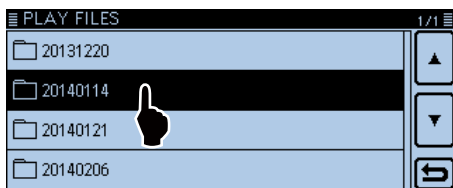

- ⑥ Touch [Delete].

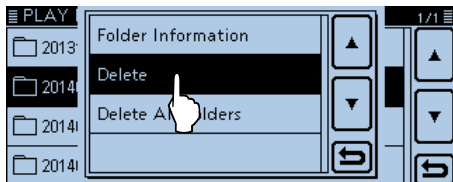

- ⑦ Touch [Yes].
 - A beep sounds, and then the folder is deleted.

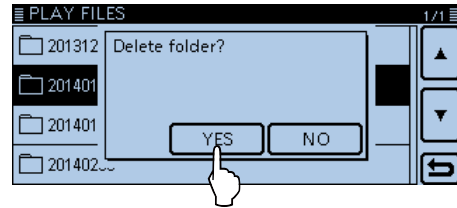

- ⑧ Touch [MENU].
 - Cancels the Menu screen.

Delete all folders:

You can select “Delete All Folders” in Step ⑥.

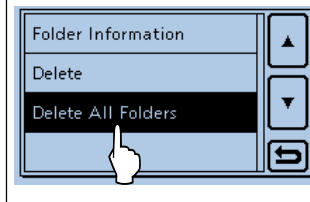

Deleting the audio folder/file (continued)

◆ Delete an Audio File

▨ All audio files in the folder.

- ① Touch [MENU].
 - Opens the Menu screen.
- ② Touch “Voice Memo.”

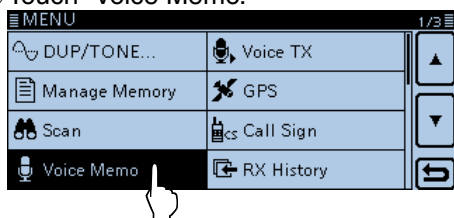

- ③ Touch “QSO Recorder.”

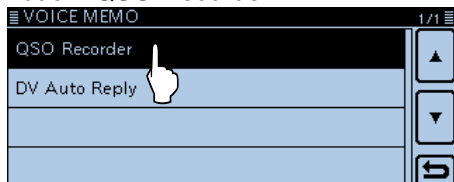

- ④ Touch “Play Files.”
 - The recorded file folders appear.

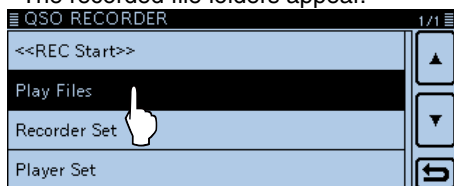

- ⑤ Touch the folder that contains the audio file to delete.

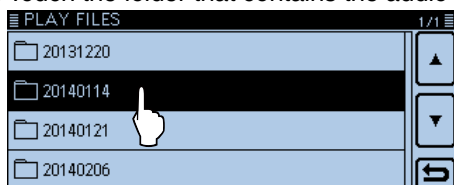

- ⑥ Touch and hold the file to delete, for 1 second.

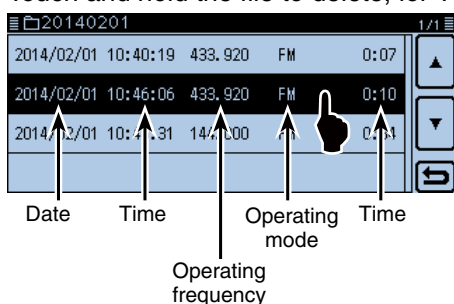

- ⑦ Touch [Delete].

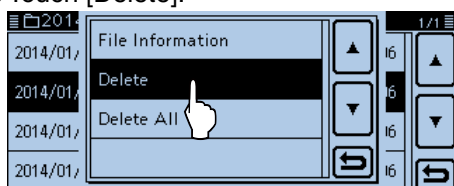

- ⑧ Touch [Yes].
 - A beep sounds, and then the file is deleted.

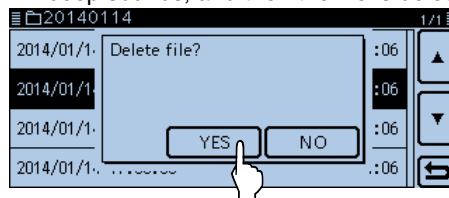

- ⑨ Touch [MENU].
 - Cancels the Menu screen.

Delete all folders:
 You can select “Delete All” in Step ⑦ to delete files in the folder.

Viewing the file information

The recorded audio file contains the recording data (operating frequency, operating mode, recorded date, and so on).

- ① View the audio file list in the Menu screen. (Voice Memo > QSO Recorder > Play Files)
- ② Touch the folder that contains the file to view the information.

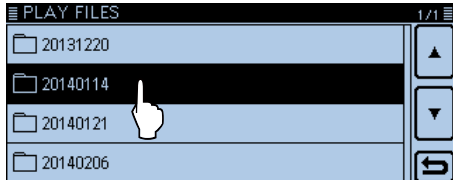

- ③ Touch and hold the file to view the information, for 1 second.

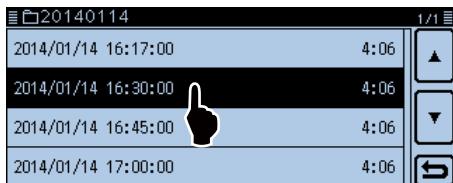

- ④ Touch "File Information."
- The File Information screen appears.

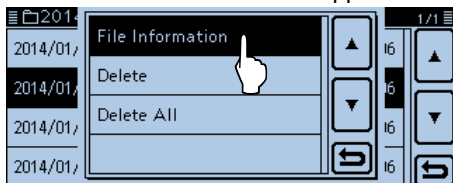

For your reference:

View the folder information:

Touch [QUICK] in Step ②, and then touch "Folder Information" to view the folder information.

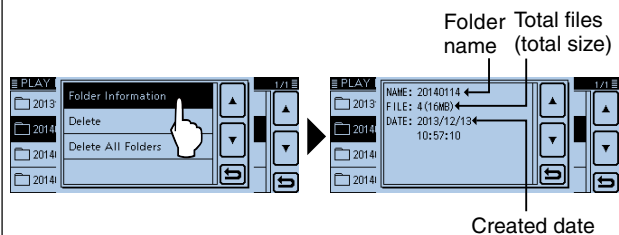

File information examples:

• TX audio file information

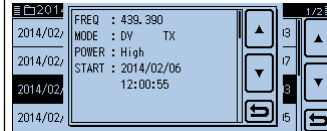

Operating information (TX)

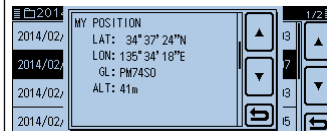

MY station location

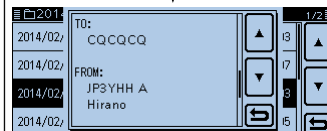

DR setting information

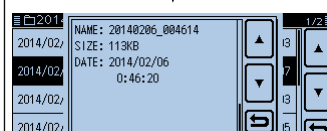

File data

• RX audio file information

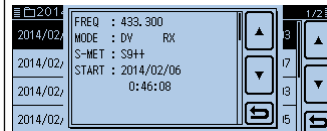

Operating information (RX)

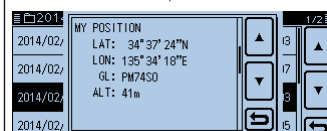

My station location

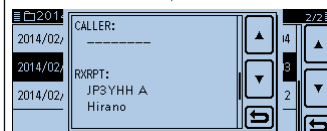

Caller and received repeater

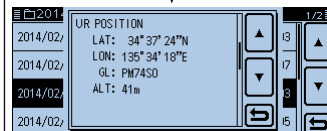

UR station location

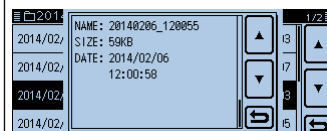

File data

Viewing the SD card memory capacity

You can verify the SD card memory capacity and available recording time.

- ① Touch [MENU].
- ② Touch the "SD Card Info."
(SD Card > SD Card Info)
 - Remaining capacity and available recording time.

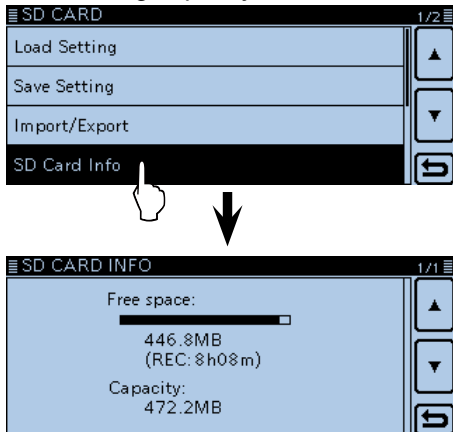

- ③ Touch [MENU].
 - Cancels the Menu screen.

Playing back the recorded audio on the PC

You can play back the recorded QSO audio on your PC.

- Operation data is not displayed.
- The following procedure is based on the Windows 7® environment.

Example: Playing back the audio file on the SD card on the PC, through the card reader (purchase locally). The same procedure applies when the audio file is on the PC's hard disk.

- ① Connect a memory card reader to the PC, and then insert the SD card into the card reader.
 - If your PC has an SD card drive, directly insert the SD card into it.

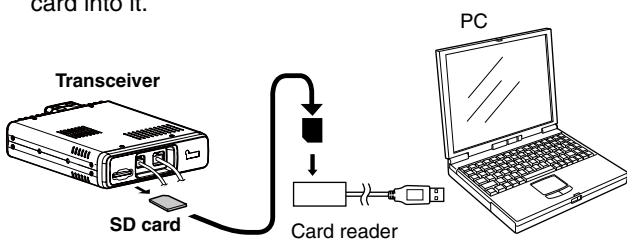

- ② Click "Open folder to view files" option to access the card.
 - Displays the 'ID-5100' folder.

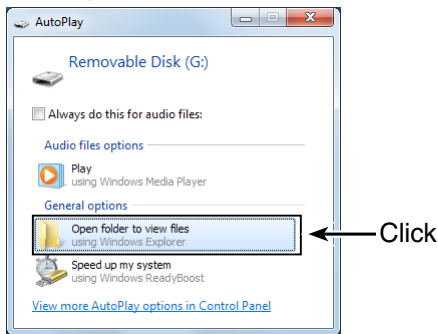

- ③ Double click 'ID-5100' folder.

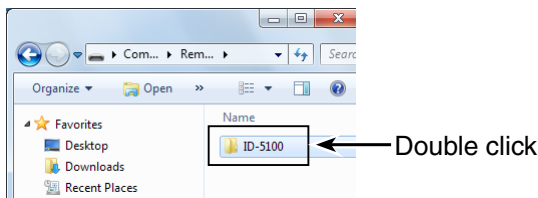

- ④ Double click 'Voice' folder.

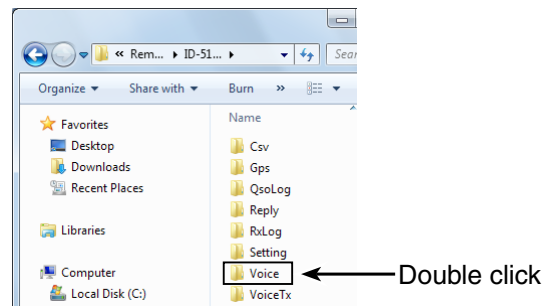

- ⑤ Double click the folder that contains the audio file to play back. (Example: "20140206")

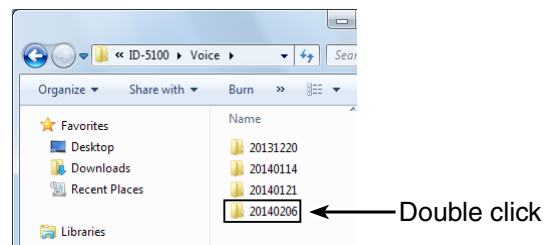

- ⑥ Double click the file to play back. (Example: "20140206_145140.wav")

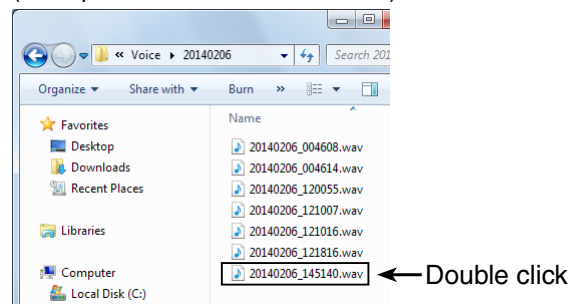

- See the instruction manual of your player for operation details.
- The audio file may not play back, depending on the player.

Section 11 REPEATER AND DUPLEX OPERATIONS

FM Repeater operation	11-2
◇ Checking the repeater input signal.....	11-3
◇ 1750 Hz tone burst.....	11-3
Duplex operation	11-4
◇ Setting the frequency offset.....	11-4
◇ Setting the duplex direction	11-4
◇ Duplex operation	11-4
Off band indication	11-5
Auto repeater function	11-6
◇ Frequency range and offset direction	11-6

FM Repeater operation

A repeater receives signals and on one frequency, and then retransmits them on a different frequency. When using a repeater, the transmit frequency is shifted from the receive frequency by a frequency offset.

A repeater can be accessed using the duplex function by setting the transceiver's offset to the same value as the repeater's offset.

See Sections 6 and 7 for details on accessing a D-STAR repeater.

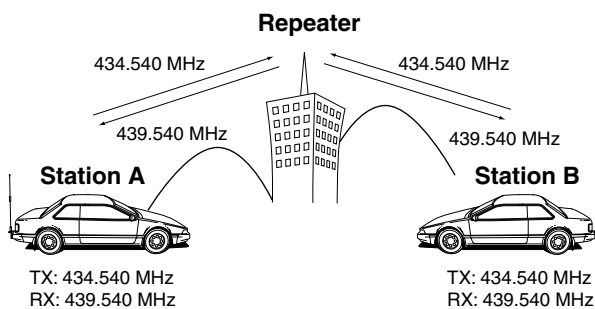

① Select the VFO mode.

- ① Touch the Memory channel number.
 - Opens the Mode setting window.
- ② Touch [VFO].

② Select the operating band.

- ① Touch the MHz digits.
 - Opens the operating band setting window.
- ② Touch [144] or [430].

③ Select the FM mode.

- ① Touch the Mode icon.
 - Opens the operating mode setting window.
- ② Touch [FM].

④ Rotate [DIAL] to set the receive frequency (Repeater output frequency).

- When the Auto Repeater function is turned ON (available in only the U.S.A. and Korea versions), steps ⑧ and ⑨ are not necessary. (p. 11-6)

⑤ Touch the Function group icon one or more times.

- Selects the F-3 menu.

⑥ Touch [DUP].

- Opens the duplex direction setting window.

⑦ Touch the desired offset direction.

- “DUP-” or “DUP+” appears.
- The offset can be set in the Menu screen. (DUP/TONE... > **Offset Freq**) (p. 12-12)

⑧ Touch [TONE].

- Opens a Tone function setting window.

⑨ Touch “TONE.”

- Turns ON the repeater tone.
- “TONE” appears.
- The tone frequency can be set in the Menu screen. (DUP/TONE... > **Repeater Tone**) (p. 12-12)

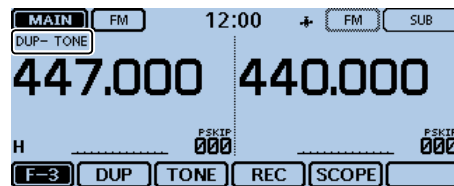

⑩ Operate in the normal way.

- Subaudible tone is superimposed on your transmit signal.

For your reference:

- If the Repeater tone frequency or the frequency offset is changed, the tone or offset for auto repeater function is also changed.
- If the offset value will cause the transmit frequency to be out of the band, “OFF BAND” appears on the display when [PTT] is pushed, and transmit will be inhibited. (p. 11-5)

FM Repeater operation (Continued)

◇ Checking the repeater input signal

You can check whether another station's transmit signal can be received directly or not, by listening to the repeater input frequency.

- ➔ In the F-1 menu, touch [MONI] to listen on the repeater input frequency.
 - While monitoring, "BUSY" blinks.
 - While monitoring, the displayed frequency automatically changes to the transceiver transmit frequency (repeater input frequency).
 - When the other station's signal can be directly received, move to a non-repeater frequency and use simplex. (duplex OFF)
 - While monitoring, the Attenuator function is temporarily disabled to receive a weak signal.

While monitoring

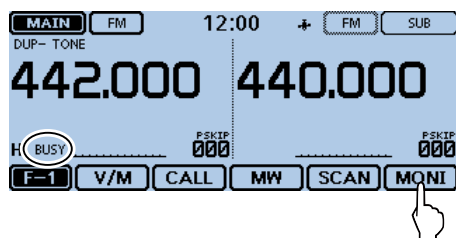

◇ 1750 Hz tone burst

A 1750 Hz tone is required to access many European repeaters.

- ① In the FM mode, touch the Function group icon one or more times.
 - Selects the F-3 menu.
- ② Push [PTT] on the microphone to transmit, and then touch [TONE] once to access the repeater with a short tone burst.
 - "1750Hz TONE" briefly appears.
 - This operation is only for the ID-5100E.
 - You can also send the 1750 Hz tone by pushing the microphone key that has the [T-CALL] function to it. See page 12-54 for microphone key assignment details.
- ③ Operate in the normal way.

Sending the tone burst

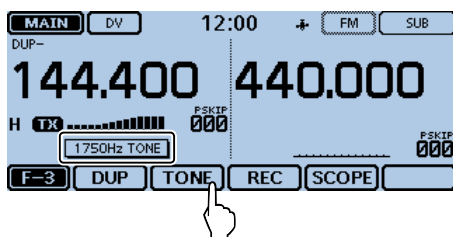

Duplex operation

The Duplex operation shifts the transmit frequency up or down from the receive frequency by an offset amount.

◇ Setting the frequency offset

- ① Touch the Memory channel number.
 - Opens the Mode setting window.
- ② Touch [VFO].
 - Selects the VFO mode.
- ③ Touch [MENU].
- ④ Touch “Offset Freq.”
 - (DUP/TONE... > Offset Freq)

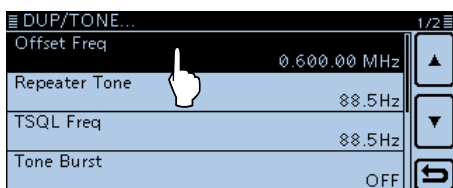

- ⑤ Touch the numbers to enter the desired offset.
 - (Example: 0.700.00 MHz)
 - Between 0.000.00 and 59.99500 MHz.
 - The selected tuning step in the VFO mode is used when setting the frequency offset.
 - If desired, touch “CE” to delete the entry.

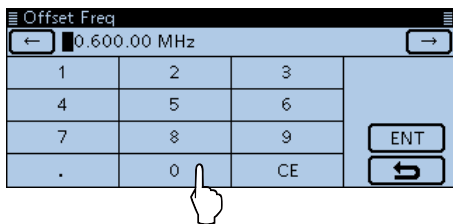

- ⑥ Touch [ENT] to set the offset.
 - Exits from the “Offset Freq” screen.
 - Sets the offset.



- ⑦ Touch [MENU].
 - Closes the Menu screen.

NOTE:

The frequency offset cannot be changed in the DR function.

For your reference:

If the offset value will cause the transmit frequency to be out of the band, “OFF BAND” appears on the display when [PTT] is pushed, and transmit will be inhibited. (p. 11-5)

◇ Setting the duplex direction

- ① Touch the Function group icon one or more times.
 - Selects the F-3 menu.
- ② Touch [DUP].
 - Opens the duplex direction setting window.

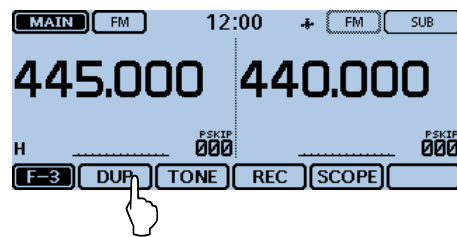

- ③ Touch the desired option.
 - OFF: For simplex operation (the receive and transmit frequencies are the same).
 - DUP-: The transmit frequency shifts down from the receive frequency by the offset amount.
 - DUP+: The transmit frequency shifts up from the receive frequency by the offset amount.
 - After setting, “DUP-” or “DUP+” appears.

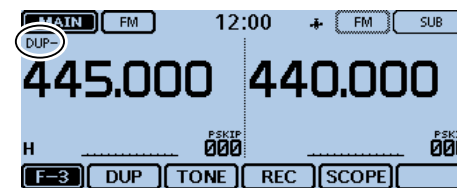
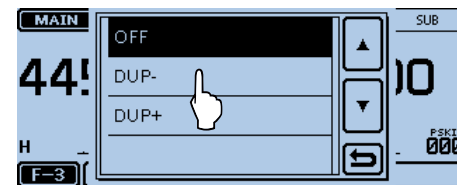

◇ Duplex operation

- ① Touch [MONI] to listen to the transmit frequency to check whether another station is transmitting on it, or not.
 - The transceiver transmit frequency appears on the display.
- ② Touch [MONI] again to turn OFF monitoring, and then operate in the normal way.

NOTE:

When the Auto repeater is ON, and the operating frequency is set out of the repeater output frequency range, the duplex mode is automatically cancelled.

Off band indication

If the transmit frequency is out of the amateur band, the off band indication, "OFF BAND," appears on the display when [PTT] is pushed. Check the frequency offset (p. 11-4) or duplex direction (p. 11-4) in this case.

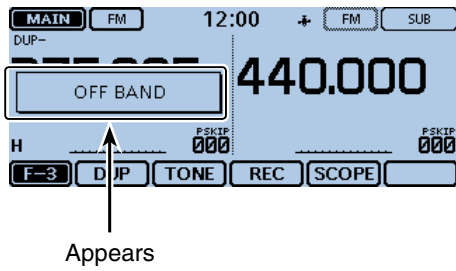

Auto repeater function

When the operating frequency falls within the repeater output frequency range, the Auto Repeater function automatically sets the repeater settings (duplex ON/OFF, duplex direction, tone encoder ON/OFF).

The Auto repeater function uses the preset repeater tone frequency and frequency offset.

See page 12-12 for details of the setting.

① Touch [MENU].

② Touch "Auto Repeater."

(Function > **Auto Repeater**)

- If the item is not displayed, touch [▲] or [▼] one or more times to select another page.

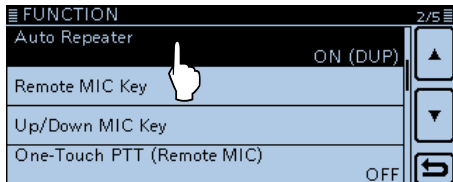

③ Touch the desired option to turn ON the Auto Repeater function.

USA version:

- OFF: The Auto repeater function is OFF.
- ON (DUP): Turns ON only the duplex operation. (Default)
- ON (DUP, TONE): Turns ON the duplex operation and tone encoder

Korean version:

- OFF: The Auto repeater function is OFF.
- ON: Turns ON the duplex operation and tone encoder. (Default)

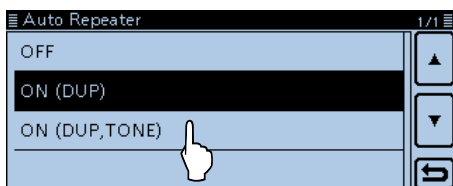

④ Touch [MENU]

- Closes the Menu screen.

For the U.S.A. and Korean versions:

When turned ON, the Auto repeater function has priority over the manual duplex setting. If the transmit frequency changes after setting, the Auto repeater function may have changed the duplex setting.

◇ Frequency range and offset direction

• U.S.A. version

FREQUENCY RANGE	SHIFT DIRECTION
145.200–145.495 MHz	"DUP–" is set
146.610–146.995 MHz	"DUP–" is set
147.000–147.395 MHz	"DUP+" is set
442.000–444.995 MHz	"DUP+" is set
447.000–449.995 MHz	"DUP–" is set

• Korean version

FREQUENCY RANGE	SHIFT DIRECTION
439.000–440.000 MHz	"DUP–" is set

Section 12 MENU SCREEN

Menu item selection	12-2
◇ Entering the Menu screen	12-2
Menu items and Default settings	12-3
DUP/TONE items.....	12-12
Manage Memory items.....	12-13
Scan items.....	12-14
Voice Memo items (For Record/Playback).....	12-17
Voice TX items.....	12-19
GPS items.....	12-20
Call Sign items.....	12-37
RX History items.....	12-38
DV Memory items	12-41
My Station items	12-43
DV Set items.....	12-44
SPEECH items	12-46
DTMF items	12-48
QSO/RX Log items.....	12-49
Function items	12-52
Display items	12-57
Sounds items	12-61
Time Set items	12-62
SD Card items.....	12-63
Bluetooth Set items.....	12-64
Others items.....	12-67

Menu item selection

The Menu screen is used to program infrequently changed values or function settings.

In addition to this page, see pages 12-3 through 12-11 for details of each item's options and their default value.

NOTE: The Menu system is constructed in a tree structure. You may go to the next tree level, or go back a level, depending on the selected item.

Menu items

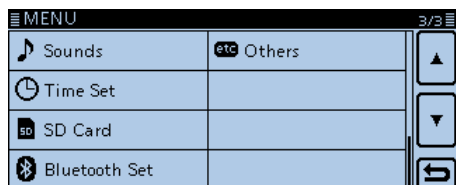
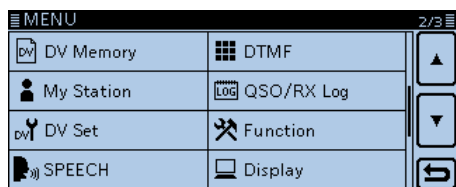
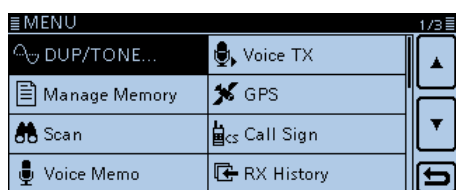

◇ Entering the Menu screen

Example: Set the Auto Power OFF function to “30 min.”

- ① Touch [MENU].
- ② Touch [▲] or [▼] one or more times to select the page.
 - If you continuously hold down [▲] or [▼], the items are quickly scrolled.
 - You can select an item by rotating [DIAL].
- ③ Touch “Time Set.”

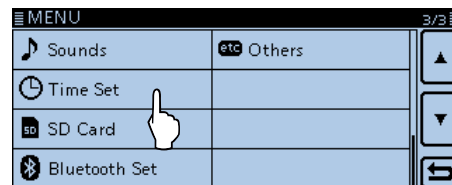

- ④ Touch “Auto Power OFF.”
 - To set other item, touch [↵] to go back a tree level.

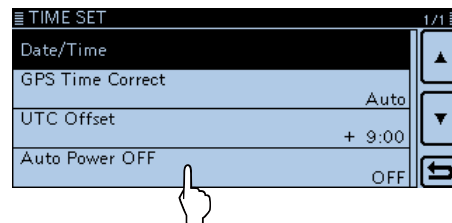

- ⑤ Touch “30min.”

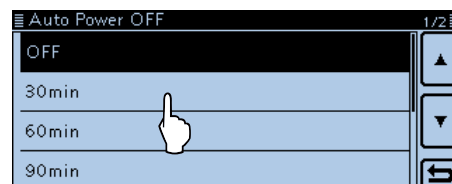

- ⑥ Touch [MENU]
 - Closes the Menu screen.

To return to the default setting:

Touch [QUICK] in step ⑤, and then touch “Default.”

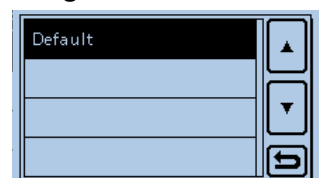

Menu items and Default settings

NOTE: The default settings shown in bold letters below are for the USA version.
The default settings may differ, depending on your transceiver version.

DUP/TONE...	Settings to access repeaters.	
Offset Freq	0.000~ 0.600.00 *1~59.995 MHz	Sets the frequency offset for duplex (repeater) operation.
Repeater Tone	67.0~ 88.5 ~254.1 Hz	Selects a tone frequency used to access the repeaters.
TSQL Freq	67.0~ 88.5 ~254.1 Hz	Selects a tone frequency for the Tone squelch or the pocket beep function.
Tone Burst	OFF or ON	Turns the Tone Burst function ON or OFF. This function is used to suppress the squelch tail noise heard from the transceiver's speaker.
DTCS Code	023 ~754	Selects a DTCS (both encoder/decoder) code for DTCS squelch or the pocket beep function.
DTCS Polarity	Both N , TN-RR, TR-RN or Both R	Selects the DTCS polarity for the DTCS squelch or the pocket beep function.
Digital Code	00 ~99	Selects a digital code for the Digital Code squelch function.
Manage Memory	Manage your Memory or Call channel data.	
Memory CH	ALL, A~Z	Manages for the Memory channels.
Call CH	C0/C1(144):146.010 FM*2 C0/C1(430):440.000 FM*2	Manages for the Call channels.
Scan	Set scan options.	
Pause Timer	2sec~ 10sec ~20sec or HOLD	Selects the scan pause time. When receiving signals, the scan pauses according to the scan pause timer.
Resume Timer	0sec~ 2sec ~5sec or HOLD	Selects the scan resume time from a pause after the received signal disappears.
Temporary Skip Timer	5min , 10min or 15min	Selects the Temporary Skip Time. When the time is set, specified frequencies are skipped for this period during a scan.
Program Skip	OFF or ON	Turns the Program Skip Scan function ON or OFF for a VFO mode scan.
Bank Link	A: <input checked="" type="checkbox"/> ~Z: <input checked="" type="checkbox"/>	Selects banks to be scanned during a Bank Link Scan.
Program Scan Edge	00~24	Sets the frequency ranges for the program scan.
Program Link		Sets the link function for the program scan edge channels.
See page 12-15 for details of the preset values.		
Voice Memo	Set the TX/RX voice recording options.	
QSO Recorder		
<<REC Start>>*3		Starts recording the received signal audio.
Play Files*3	PLAY FILES	Plays or deletes the recorded audio.
Recorder Set		
REC Mode	TX&RX or RX Only	Selects to record the TX audio or not.
RX REC Condition	Always or Squelch Auto	Selects whether or not the squelch status affects the RX voice audio recording.
File Split	OFF or ON	Selects whether or not to automatically create a new file if transmission and reception, or squelch status (open and close) is switched.
PTT Auto REC	OFF or ON	Turns the PTT Automatic Recording function ON or OFF.
Player Set		
Skip Time	3sec, 5sec, 10sec or 30sec	Sets the Skip time to rewind or forward the recorded audio when you push the fast-rewind or fast-forward key during playback.

*1 The default value may differ, depending on the frequency band (selected as the MAIN band before entering the Menu screen) and the transceiver version.

*2 The default value may differ, depending on the transceiver version.

*3 Be sure to insert the SD card into the transceiver before selecting these items.

Menu items and Default settings (Continued)

/// **NOTE:** The default settings shown in bold letters below are for the USA version.
 /// The default settings may differ, depending on your transceiver version.

DV Auto Reply* ¹		Records a voice audio to use the Auto Reply function in the DV mode.
Voice TX	Set microphone voice recording options.	
Record* ¹	T1~T4	Starts recording the microphone audio.
TX Set		
Repeat Time	1sec~ 5sec ~15sec	Sets the repeat interval. The transceiver repeatedly transmits the recorded voice audio at this interval.
TX Monitor	OFF or ON	The TX Monitor function outputs the TX voice audio from the speaker during voice transmission.
<<TX>>* ¹	T1~T4, Repeat TX	The transceiver transmits the recorded voice audio.
GPS	Set the GPS options.	
GPS Set		
GPS Select	OFF, Internal GPS or Manual	Selects the position data source that the transceiver uses for its position data.
Manual Position	Manually enter your current position.	
GPS Out (To DATA Jack)	OFF or ON	Selects to output the GPS information to the [DATA] jack
GPS TX Mode		
OFF	Turns OFF the GPS TX function.	
D-PRS		
Unproto Address	API510,DSTAR*	Enters an unproto address, or keep the default.
TX Format		
Position		
Symbol	1:Car, 2:Van, 3:Truck or 4:House QTH (VHF)	Selects a desired D-PRS Symbol to transmit.
SSID	- - -, (-0), -1~-15 or -A~-Z	Selects the APRS® call sign SSID.
Comment	Enters a comment to transmit.	
Time Stamp	OFF , DHM or HMS	Selects a format to transmit the current UTC time as a time stamp.
Altitude	OFF or ON	Turns the altitude transmit option ON or OFF.
Data Extension	OFF , Course/Speed or Power/Height/Gain/Directivity	Selects whether to transmit the course/speed data, power/height/gain/directivity data or not.
Power	0W , 1W, 4W, 9W, 16W, 25W, 36W, 49W, 64W or 81W	Selects the TX power level information to send when using as a base station.
Height	10ft , 20ft, 40ft, 80ft, 160ft, 320ft, 640ft, 1280ft, 2560ft, 5120ft* ²	Selects the height information to send when using as a base station.
Gain	0dB ~9dB	Selects the antenna gain information to send when using as a base station.
Directivity	Omni , 45°NE, 90°E, 135°SE, 180°S, 225°SW, 270°W, 315°NW, 360°N	Selects the antenna directivity information to send when using as a base station.
Object		
Object Name	Enters a object station name to transmit.	
Data Type	Live Object , Killed Object	Selects a object station's status to transmit.
Symbol	Radio	Selects a object station's symbol to transmit.
Comment	Enters a object station's comment to transmit.	
Position	Sets a object station's position data to transmit.	
Data Extension	OFF , Course/Speed or Power/Height/Gain/Directivity	Selects whether to transmit the object station's course/speed data, power/height/gain/directivity data or not.
Course	0° ~360°	Sets a object station's course to transmit.
Speed	0mph ~1150mph* ²	Sets a object station's speed to transmit.
Power	0W , 1W, 4W, 9W, 16W, 25W, 36W, 49W, 64W or 81W	Selects a object station's TX power level information to transmit.
Height	10ft , 20ft, 40ft, 80ft, 160ft, 320ft, 640ft, 1280ft, 2560ft, 5120ft* ²	Selects the height information of the object station to transmit.
Gain	0dB ~9dB	Selects the antenna gain information of the object station to transmit.

*¹ Be sure to insert the SD card into the transceiver before selecting these items.

*² The unit may differ, depending on the "Display Unit" settings. (p. 12-59)

Menu items and Default settings (Continued)

/// **NOTE:** The default settings shown in bold letters below are for the USA version.
 /// The default settings may differ, depending on your transceiver version.

Directivity	Omni , 45°NE, 90°E, 135°SE, 180°S, 225°SW, 270°W, 315°NW, 360°N	Selects the antenna directivity information of the object station to transmit.
SSID	--- , (-0), -1~-15 or -A~-Z	Selects the APRS® call sign SSID for the object station.
Time Stamp	DHM or HMS	Selects a format to transmit the current UTC time as a time stamp.
Item		
Item Name		Enters a item station name to transmit.
Data Type	Live Item , Killed Item	Selects a item station's status to transmit.
Symbol	Radio	Selects a item station's symbol to transmit.
Comment		Enters a item station's comment to transmit.
Position		Sets a item station's position data to transmit.
Data Extension	OFF , Course/Speed or Power/Height/Gain/Directivity	Selects whether to transmit the item station's course/speed data, power/height/gain/directivity data or not.
Course	0°~360°	Sets a item station's course to transmit.
Speed	0mph~1150mph*1	Sets a item station's speed to transmit.
Power	0W , 1W, 4W, 9W, 16W, 25W, 36W, 49W, 64W or 81W	Selects a item station's TX power level information to transmit.
Height	10ft , 20ft, 40ft, 80ft, 160ft, 320ft, 640ft, 1280ft, 2560ft, 5120ft*1	Selects the height information of the item station to transmit.
Gain	0dB~9dB	Selects the antenna gain information of the item station to transmit.
Directivity	Omni , 45°NE, 90°E, 135°SE, 180°S, 225°SW, 270°W, 315°NW, 360°N	Selects the antenna directivity information of the item station to transmit.
SSID	--- , (-0), -1~-15 or -A~-Z	Selects the APRS® call sign SSID for the item station.
Weather		
Symbol	WX Station	Selects a weather station's symbol to transmit.
SSID	--- , (-0), -1~-15 or -A~-Z	Selects the APRS® call sign SSID for the weather station.
Comment		Enters a weather station's comment to transmit.
Time Stamp	OFF, DHM or HMS	Selects a format to transmit the current UTC time as a time stamp.
NMEA		
GPS Sentence	RMC, GGA , GLL, VTG, GSA or GSV	Transmits position data in selected GPS sentences.
GPS Message		Enter a GPS message to be transmitted.
GPS Information		Displays the received GPS information.
GPS Position		Displays your position, RX station, GPS memory and Alarm positions.
GPS Memory	(No Group), A~Z	Shows the GPS memory contents.
GPS Alarm		
Alarm Select	OFF , RX, Group or Memory	Select the target for the GPS alarm function.
Alarm Area (Group)	0°05"/0.08'~ 0°15"/0.25' ~59°59"/59.99'	Enter the GPS alarm active range.
Alarm Area (RX/Memory)	Limited, Extended or Both	Select the GPS alarm active range.
GPS Logger*2		
GPS Logger	OFF or ON	Turns the GPS logger function ON or OFF, to store your route as you move.
Record Interval	1sec, 5sec , 10sec, 30sec or 60sec	Selects the GPS Logger function record interval.
GPS Auto TX	OFF , 5sec, 10sec, 30sec, 1min, 3min, 5min, 10min or 30min	Selects a time option for the GPS automatic transmission function.

*1 The unit may differ, depending on the "Display Unit" settings. (p. 12-59)

*2 Be sure to insert the SD card into the transceiver before selecting these items.

Menu items and Default settings (Continued)

/// **NOTE:** The default settings shown in bold letters below are for the USA version.
 /// The default settings may differ, depending on your transceiver version.

Call Sign	Set and display the DV mode call signs.	
UR: CQCQCQ, R1: -----, R2: -----, MY: -----		Displays the operating call signs. Sets the operating call signs according to the type of call you want to make.
RX History	Displays the received call history in the DV mode.	
LAST (MAIN)		Displays the calls your transceiver received.
DV Memory	Stores call signs or repeater information to use in the DV mode.	
Your Call Sign	Blank	Stores station call signs. Add or edit call signs.
Repeater List (See page 7-37 for details of the pre-loaded data.)	01:~30:	Stores repeater information. Add or edit a repeater information.
/// NOTE: The repeater list described in this manual may differ from your preloaded list.		
My Station	Sets and stores your call sign to use in the DV mode.	
My Call Sign	1:~6:	Stores your own call signs. Select or edit a call sign to use in the DV mode.
TX Message	1:~5: or OFF	Stores TX Messages. Select or edit TX Message to use in the DV mode.
DV Set	Sets values for the DV mode operations.	
Tone Control		
RX Bass	Cut, Normal or Boost	Sets the DV mode received audio bass filter level to Cut, Normal or Boost.
RX Treble	Cut, Normal or Boost	Sets the DV mode received audio treble filter level to Cut, Normal or Boost.
RX Bass Boost	OFF or ON	Turns the DV mode received audio Bass Boost function ON or OFF
TX Bass	Cut, Normal or Boost	Sets the DV mode transmit audio bass filter level to Cut, Normal or Boost.
TX Treble	Cut, Normal or Boost	Sets the DV mode transmit audio treble filter level to Cut, Normal or Boost.
Auto Reply	OFF , ON, Voice, Position (Main Only) or Position (Main/Sub)	Selects the Automatic Reply function.
DV Data TX	PTT or Auto	Selects manually or automatically to transmit low speed data.
Digital Monitor	Auto , Digital or Analog	Selects the DV mode RX monitoring when [SQL] is held down.
Digital Repeater Set	OFF or ON	Turns the digital repeater setting function ON or OFF. This function is usable in any DV mode except using the DR function.
DV Auto Detect	OFF or ON	Turns the DV mode automatic detect function ON or OFF.
RX Record (RPT)	ALL or Latest Only	The transceiver can record the data of up to 50 individual calls.
BK	OFF or ON	Turns the BK (Break-in) function ON or OFF. The BK function allows you to break into a conversation between two stations with call sign squelch enabled.
EMR	OFF or ON	Turns the EMR (Enhanced Monitor Request) communication mode ON or OFF. After turning OFF the transceiver, the EMR mode will be cancelled.
EMR AF Level	0~ 19 ~32	Sets the audio output level when an EMR mode signal is received.

Menu items and Default settings (Continued)

/// **NOTE:** The default settings shown in bold letters below are for the USA version.
 /// The default settings may differ, depending on your transceiver version.

SPEECH Sets the Speech functions.		
RX Call Sign SPEECH	OFF, ON (Kerchunk) or ON (All)	Selects the RX call sign speech function option while ON, or turn it OFF.
RX>CS SPEECH	OFF or ON	Turns the RX>CS Speech function ON or OFF.
DIAL SPEECH	OFF or ON	Turn the Dial Speech function ON or OFF.
MODE SPEECH	OFF or ON	Turn the Operating Mode Speech function ON or OFF.
SPEECH Language	English or Japanese	Selects either English or Japanese as the desired speech language.
Alphabet	Normal or Phonetic Code	Selects the alphabet character announcement type.
SPEECH Speed	Slow or Fast	Selects Slow or Fast speech speed
SPEECH Level	0~7~9	Sets the volume level for the voice synthesizer.
DTMF Sets the DTMF Memory functions.		
DTMF Memory	d0 :~d9:, dA:~dD:, d*: or d#:	Shows a list of the DTMF memory channels. The DTMF memory can store up to 24-digit DTMF code.
DTMF Speed	100ms , 200ms, 300ms or 500ms	Selects the DTMF transmit speed.
QSO/RX Log Sets the QSO/RX History Log options.		
QSO Log*1	OFF or ON	Selects to make a communication log on the SD card, or not.
RX History Log*1	OFF or ON	Selects to make a DV mode's receive history log on the SD card, or not.
CSV Format		
Separator/Decimal	Sep [.] Dec [.] , Sep [:] Dec [.] or Sep [.] Dec [.]	Selects the separator and the decimal character for the CSV format.
Date	yyyy/mm/dd, mm/dd/yyyy or dd/mm/yyyy	Selects the date format.
Function Sets various function's options.		
Squelch/ATT Select	OFF, S-Meter Squelch , ATT	Selects to use the S-Meter Squelch or the Attenuator function for the [SQL] control.
Squelch Delay	Short , Long	Selects to shorten or lengthen the time until the squelch opens.
Fan Control	Slow, Mid, Fast or Auto	Selects the cooling fan control condition.
Dial Speed-UP	OFF or ON	Turns the dial speed acceleration ON or OFF.
Auto Repeater*2	OFF or ON (DUP) , ON (DUPTONE)	Turns the Auto Repeater function ON or OFF.
Remote MIC Key		
During RX/Standby	[F-1]:BAND/BANK [F-2]:Monitor	Selects the key function to be used while receiving or in the standby mode.
During TX	[F-1]:T-CALL [F-2]:---	Selects the key function to be used while transmitting.
Up/Down MIC Key		
During RX/Standby	[UP]:UP [DN]:DOWN	Selects the key function to be used while receiving or in the standby mode.
During TX	[UP]:--- [DN]:---	Selects the key function to be used while transmitting.
One-Touch PTT(Remote MIC)	OFF or ON	Turns the One-Touch PTT function ON or OFF.
PTT Lock	OFF or ON	Turns the PTT Lock function ON or OFF.
Busy Lockout	OFF or ON	Turns the Busy Lockout function ON or OFF.
Time-Out Timer	OFF , 1min, 3min, 5min, 10min, 15min or 30min	Selects the Time-Out Timer time options.

*1 Be sure to insert the SD card into the transceiver before selecting these items.

*2 Appears only in the Korean and U.S.A. version transceivers.

Menu items and Default settings (Continued)

/// **NOTE:** The default settings shown in bold letters below are for the USA version.
 /// The default settings may differ, depending on your transceiver version.

Active Band	Single or All	Allows continuous frequency selection across all bands by rotating [DIAL].
MIC Gain	1~ 2 *~4	Sets the microphone sensitivity to suit your preference.
Touch Operation (Sub)	Main Select or Function Select	Sets the touch operation on the SUB band display.
Keyboard Type	Ten-key, Full keyboard	Selects the keyboard entry type to enter a call sign, memory name, and so on.
Data Speed	4800bps or 9600bps	Selects the data transmission speed for low-speed communication, or between the [DATA] jack and external modules like a GPS receiver, and so on.
CI-V		
CI-V Address	01h~ 8Ch ~DFh	Sets the transceiver's unique CI-V hexadecimal address code.
CI-V Baud Rate	4800, 9600, 19200 or Auto	Sets the CI-V code transfer speed.
CI-V Transceive	OFF or ON	Turns the CI-V Transceive function ON or OFF.
CI-V Bluetooth→REMOTE transceive Address	00h ~DFh	Sets the address to inhibit the external control with CI-V for the transceiver through the [SP2] (REMOTE) jack.
Heterodyne		
Heterodyne (A BAND VHF)	Normal or Reverse	Effective to eliminate internal spurious that may occur in a rare combination of dual band frequencies, when operating VHF on the A band.
Heterodyne (A BAND UHF)	Normal or Reverse	Effective to eliminate internal spurious that may occur in a rare combination of dual band frequencies, when operating UHF on the A band.
Heterodyne (B BAND UHF)	Normal or Reverse	Effective to eliminate internal spurious that may occur in a rare combination of dual band frequencies, when operating UHF on the B band.
Power OFF (With No Controller)	OFF or ON	Selects whether or not to automatically turn OFF the transceiver when the controller is disconnected from the transceiver.
Display		
Backlight	1~ 8	Selects the transceiver backlight option.
Auto Dimmer	OFF , Auto-OFF, Auto-1~7	Selects the Auto dimmer function, and the dimmer level.
Auto Dimmer Timer	5sec , 10sec	Selects the backlight ON time period.
Touch Operation (Dimmed)	Brighten, Brighten & Action	Selects whether or not to brighten and make an action when you touch the dimmed panel.
LCD Contrast	1~ 8 ~16	Selects the contrast level of the LCD.
RX Call Sign	OFF, Normal , RX Hold or Hold	Selects the call sign and message display option when receiving a call.
RX Position Indicator	OFF or ON	Selects whether or not to display the indicator when the position data is included in the signal received in the DV mode.
RX Position Display	OFF, ON (Main/Sub) or ON (Main Only)	Selects whether or not to display the caller's position data in a dialog when the data is included in the signal received in the DV mode.
RX Position Display Timer	5sec, 10sec , 15sec, 30sec, Hold	Selects the RX position data display time period.
Reply Position Display	OFF or ON	Selects whether or not to display the caller's position data in a dialog when the data is included in the Auto Reply signal.
TX Call Sign	OFF, Your Call Sign or My Call Sign	Selects whether or not to display My or Your call sign while transmitting.
Scroll Speed	Slow or Fast	Selects the scrolling speed of the message, call sign, or other text.

* The default value may differ, depending on the transceiver version.

Menu items and Default settings (Continued)

/// **NOTE:** The default settings shown in bold letters below are for the USA version.
 /// The default settings may differ, depending on your transceiver version.

Opening Message	OFF or ON	Selects whether or not to display the opening message at power ON.
Voltage (Power ON)	OFF or ON	Selects whether or not to display the voltage of the external DC power source at power ON.
Display Unit		
Latitude/Longitude	ddd°mm.mm' , ddd°mm'ss"	Selects position format to display the position.
Altitude/Distance	m, ft/ml ^{*1}	Selects units to display the distance and altitude.
Speed	km/h, mph ^{*1} or knots	Selects units to display the speed.
Temperature	°C, °F ^{*1}	Selects units to display the temperature.
Barometric	hPa, mb, mmHg, inHg ^{*1}	Selects units to display the barometric pressure.
Rainfall	mm, inch ^{*1}	Selects units to display the rainfall.
Wind Speed	m/s, mph ^{*1} , knots	Selects units to display the wind speed.
Display Language	English or Japanese	Selects the display language in the DR screen or Menu mode. When "English" is selected in System Language, this setting will disappear.
System Language	English or Japanese	Selects English or Japanese as the system language of the transceiver.
Sounds Sets the Sound options.		
Beep Level	0~ 9	Sets the beep output level.
Key-Touch Beep	OFF or ON	Turns the confirmation beep tones when key is pushed, ON or OFF.
Home CH Beep	OFF or ON	Turns the Home CH Beep ON or OFF.
Band Edge Beep	OFF or ON	Turns the Band edge beep ON or OFF.
Scan Stop Beep	OFF or ON	Turns the scan stop beep ON or OFF.
Standby Beep	OFF, ON or ON (to me:High Tone)	Turns the standby beep function in the DV mode ON or OFF.
Sub Band Mute	OFF , Mute, Beep or Mute & Beep	Selects to mute the SUB band audio signal while receiving on the MAIN band, and/or sound a beep when a signal disappears on the SUB band.
Scope AF Output	OFF or ON	Selects the audio output option during a sweep.
Time Set Sets the Time options.		
Date/Time		
DATE	2000/01/01~2099/12/31	Sets the current date.
TIME	0:00~23:59	Sets the current time.
GPS Time Correct	OFF or Auto	Sets to automatically correct the time using a GPS signal.
UTC Offset	-14:00~ ±0:00 ~+14:00	Enters the time difference between UTC and the local time.
Auto Power OFF	OFF , 30min, 60min, 90min or 120min	Turns the Auto power OFF function ON or OFF.
SD Card ^{*2} Sets the SD card options.		
Load Setting		
File selection	ALL, Except My Station, Repeater List Only	Loads the settings file to the transceiver.
Save Setting		
<<New File>>		Saves the settings as a new file.
File selection		Saves the settings in a selected file.

*1 The default value may differ, depending on the transceiver version.

*2 Be sure to insert the SD card into the transceiver before selecting these items.

Menu items and Default settings (Continued)

NOTE: The default settings shown in bold letters below are for the USA version.
The default settings may differ, depending on your transceiver version.

Import/Export		
Import	Your Call Sign, Repeater List or GPS Memory	Selects to import the repeater list, UR call sign or GPS memory data in the CSV format file.
Export	Your Call Sign, Repeater List or GPS Memory	Selects to export the repeater list, UR call sign or GPS memory data in the CSV format file.
CSV Format		
Separator/Decimal	Sep [,] Dec [.] , Sep [;] Dec [.] or Sep [;] Dec [,]	Selects the separator and the decimal character for the CSV format.
Date	yyyy/mm/dd, mm/dd/yyyy * or dd/mm/yyyy	Selects the date format.
SD Card Info		
Format		Formats the card.
Unmount		Unmounts the card.
Bluetooth Sets the Bluetooth® options.		
Bluetooth	OFF or ON	Turns the Bluetooth® function ON or OFF.
Auto Connect	OFF or ON	Selects whether or not to automatically connect to the paired Bluetooth® device when its device is turned ON.
Pairing/Connect Selects to pair or connect to the Bluetooth® device.		
Device Search		
Search Headset		Selects to search for the Bluetooth® headset.
Search Data Device		Selects to search for the Bluetooth® data device.
Pairing list		Selects to display the paired device.
<<Pairing Reception>>		Selects to accept the connection request from the Bluetooth® device.
Headset Set		
AF Output	Headset Only or Headset & Speaker	Selects the AF output option for when you use the Bluetooth® headset.
VOX		
VOX	OFF or ON	Turn the VOX function ON or OFF for when you use the Bluetooth® headset.
VOX Level	OFF, 1~5~10	Set the MIC Gain level. • When the microphone input level is higher than this set value, the transceiver starts to transmit, and the input level is lower than this set value, returns to receive.
VOX Delay	0.5sec , 1.0sec, 1.5sec, 2.0sec, 2.5sec or 3.0sec	Sets the VOX Delay time for the transmitter stays ON after you stop speaking before the VOX switches to receive.
VOX Time-Out Timer	OFF, 1min, 2min, 3min , 4min, 5min, 10min or 15min	Sets the VOX Time-Out Timer to prevent an accidental prolonged transmission.
Icom Headset		
Power Save	OFF or ON	Sets the Power save function to prolong the headset battery.
One-Touch PTT	OFF or ON	Sets the One-Touch PTT function to toggle between transmission and reception by pushing [PTT].
PTT Beep	OFF or ON	Sets to sound a beep when you push [PTT].
Custom Key Beep	OFF or ON	Sets to sound a beep when you push the custom key ([PLAY]/[FWD]/[RWD]).
Custom Key	[PLAY]:---, [FWD]:UP, [RWD]: DOWN	Selects the key function of the custom key ([PLAY]/[FWD]/[RWD]).
Data Device Set		
Serialport Function	CI-V (Echo Back OFF) , CI-V(Echo Back ON) or DV Data	Selects to transmit or receive the CI-V command or the DV data.

* The default value may differ, depending on the transceiver version.

Menu items and Default settings (Continued)

/// **NOTE:** The default settings shown in bold letters below are for the USA version.
 /// The default settings may differ, depending on your transceiver version.

Bluetooth Device Information	Shows the optional UT-133 Bluetooth® UNIT information.
Initialize Bluetooth Device	Selects to reset the optional UT-133 Bluetooth® UNIT.

Others Set other options.

Information	
Voltage	Shows the voltage of the external DC power source.
Version	Shows the transceiver's firmware version number.
Clone	
Clone Mode	Reads or writes the CS-5100 data from or to the PC, and/or to receive data from a Master transceiver.
Repeater Mode*	
<<Repeater Mode>>	Selects the Repeater mode.
Hang Up Time	OFF or ON Selects the hangup time to cancel the transmission.
Touch Screen Calibration	Adjusts the touch screen.
Reset	
Partial Reset	Returns all settings to their defaults, without clearing the memory contents, call sign memories or repeater lists.
All Reset	Clears all programming and memories, and return all settings to their defaults.

*Does not appear, depending on the transceiver version.

DUP/TONE items

Offset frequency (Default: 0.600.00*)

DUP/TONE... > Offset Freq

Set the frequency offset for duplex (repeater) operation to between 0 and 59.99500 MHz.

- The duplex shift direction (DUP-/DUP+) is set in the duplex setting window that is displayed when you touch [DUP] in the F-3 menu.
- If the DR function is selected before selecting this item, editing is restricted.

*The default value may differ, depending on the frequency band (selected as the Main band before entering the Menu screen) and the transceiver version.

Repeater Tone (Default: 88.5)

DUP/TONE... > Repeater Tone

Select a CTCSS tone frequency for repeater access and other functions. 50 tone frequencies (67.0–254.1 Hz) are selectable.

TSQL Freq (Default: 88.5)

DUP/TONE... > TSQL Freq

Select a CTCSS tone frequency for the tone squelch or the Pocket beep function. 50 frequencies (67.0–254.1 Hz) are selectable.

• Selectable repeater tone/tone squelch frequencies (Unit: Hz)

67.0	85.4	107.2	136.5	165.5	186.2	210.7	254.1
69.3	88.5	110.9	141.3	167.9	189.9	218.1	
71.9	91.5	114.8	146.2	171.3	192.8	225.7	
74.4	94.8	118.8	151.4	173.8	196.6	229.1	
77.0	97.4	123.0	156.7	177.3	199.5	233.6	
79.7	100.0	127.3	159.8	179.9	203.5	241.8	
82.5	103.5	131.8	162.2	183.5	206.5	250.3	

Tone Burst (Default: OFF)

DUP/TONE... > Tone Burst

Turn the Tone Burst function ON or OFF in the FM mode when using tone squelch.

- OFF: When you transmit a signal that superimposes the CTCSS tone, the other station may hear a short burst of noise from their receiver, just after you stop transmitting.
- ON: When you transmit a signal that superimposes the CTCSS tone, the function mutes the noise from being heard in the other station's receiver.

DTCS Code (Default: 023)

DUP/TONE... > DTCS Code

Select a DTCS (both encoder/decoder) code for the DTCS squelch. A total of 104 codes (023–754) are selectable.

• Selectable DTCS codes

023	072	152	244	311	412	466	631
025	073	155	245	315	413	503	632
026	074	156	246	325	423	506	654
031	114	162	251	331	431	516	662
032	115	165	252	332	432	523	664
036	116	172	255	343	445	526	703
043	122	174	261	346	446	532	712
047	125	205	263	351	452	546	723
051	131	212	265	356	454	565	731
053	132	223	266	364	455	606	732
054	134	225	271	365	462	612	734
065	143	226	274	371	464	624	743
071	145	243	306	411	465	627	754

DTCS Polarity (Default: Both N)

DUP/TONE... > DTCS Polarity

Select the DTCS polarity to use for transmitting and receiving.

- Both N: Normal polarity is used for both TX and RX.
- TN-RR: Normal polarity is used for TX; Reverse polarity for RX.
- TR-RN: Reverse polarity is used for TX; Normal polarity for RX.
- Both R: Reverse polarity is used for both TX and RX.

DTCS code's polarity for transmitting or receiving can be independently set with this item.

Digital Code (Default: 00)

DUP/TONE... > Digital Code

Select the desired digital code for digital code squelch. A total of 100 codes (00–99) are selectable.

Manage Memory items

Memory CH

Manage Memory > Memory CH

You can delete, copy and edit your memory data.

Up to 1000 Memory channels can be stored.

Also, 26 memory banks, A to Z, can be used to store groups of operating channels, and so on. Up to 100 channels can be assigned to a bank.

- ALL: All Memory channels are listed.
- A–Z: Memory channels that is stored in the bank are listed.

Call CH

Manage Memory > Call CH

You can delete, copy or edit your Call channel data.

The Call channel can be assigned to 2 different channels (C0 and C1) in the 144 MHz and 430 MHz bands.

The default setting is differ, depending on the transceiver's version.

Scan items

Pause Timer (Default: 10sec)

Scan > Pause Timer

Select the scan Pause time. When receiving a signal, the scan pauses for the scan Pause Timer time.

- 2sec to 20sec : When a signal is received, the scan pauses for 2 to 20 seconds (set in 2 second steps).
- HOLD : The scan pauses on a received signal until the signal disappears.

Resume Timer (Default: 2sec)

Scan > Resume Timer

Select the scan Resume Timer time.

When a received signal disappears, the scan resumes according to the scan Resume Timer setting.

- 0sec: The scan resumes immediately after the signal disappears.
- 1sec to 5sec: The scan resumes 1 to 5 seconds after the signal disappears.
- HOLD: The scan remains paused for the Pause Timer setting, even if the signal disappears.

NOTE: Rotate [DIAL] to resume the scan.
 The Resume Timer must be set shorter than the Pause Timer, otherwise this timer does not work properly.

Temporary Skip Timer (Default: 5min)

Scan > Temporary Skip Timer

Set the Temporary Skip Timer to 5, 10 or 15 minutes.

When the time is set, the unwanted frequencies are skipped for this set period during a scan.

This timer activates for the VFO scan, Memory scan and DR scan.

Program Skip (Default: ON)

Scan > Program Skip

Turn the Program Skip Scan function ON or OFF for a VFO mode scan.

This function enables the transceiver to skip the unwanted frequencies or channels that inconveniently stop scanning.

Set the unwanted frequencies or channels to "PSKIP" in the Memory Channel screen.

- OFF: The transceiver scans all frequencies.
- ON: The transceiver does not scan frequencies set as "PSKIP" frequencies.

Bank Link (Default: A:☑ – Z:☑)

Scan > Bank Link

Select banks to be scanned during a Bank Link Scan. The Bank Link function scans all channels in the selected banks.

Touch a desired bank, A to Z to turn the link ON or OFF.

Program Scan Edge

Scan > Program Scan Edge

You can delete, copy or edit the lower and higher frequencies for programmed scans.

A total of up to 25 frequency ranges (00–24) can be programmed.

You can set the scan name, tuning step and the receive mode for each scan edge.

The default setting is differ, depending on the transceiver's version.

See page 4-12 for Entering scan edges.

Scan items (Continued)

Program Link (Default: Refer to the diagram below)

Scan > Program Link

This item sets the link function for two or more program scan edge ranges to be sequentially scanned during the Program Link Scan.

The link function scans all frequencies in the scan range.

Default settings of the Program Link

The Program Scan Edge channels "01" and "02" are set in the Program Link number "0" as the Default.

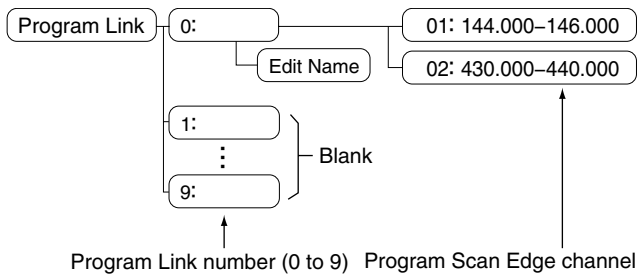

- The Program Link number screen shows the frequency range. (The default scan edge frequency may differ, depending on the transceiver version.)
- You can add a link setting with touching [QUICK] when two or more pairs of Program Scan Edge channels are programmed.

NOTE: The "Add" item will not be displayed when only one program scan edge range is programmed, or no programmed scan channel (00 to 24) is left to add to the selected link channel.

Adding a Scan Edge channel to the Program Link

- ① Touch a Program Link number between 0 and 9.
- ② Touch [QUICK].
- ③ Touch "Add."

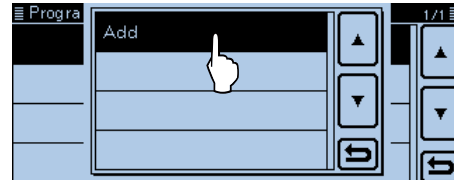

- ④ Touch a programmed scan number you wish to assign to the selected link channel. (Example: 00: 118.000-550.000)

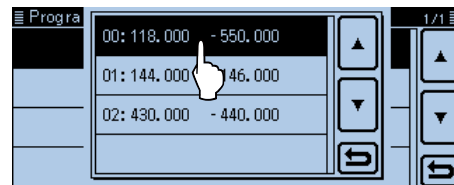

- ⑤ Push [MENU].
 - Closes the Menu screen.

Deleting the link channel

- ① Touch a Program Link number between 0 and 9.
- ② Touch the programmed scan number you wish to delete. (Example: 02: 430.000-440.000)

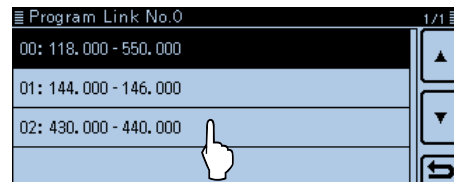

- ③ Push [QUICK].
- ④ Touch "Delete."

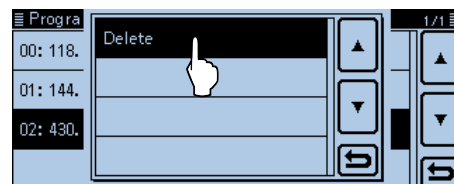

- ⑤ Push [MENU].
 - Closes the Menu screen.

Scan items (Continued)

Program scan link name programming

- ① Touch a Program Link number between 0 and 9 for 1 second to edit a name.

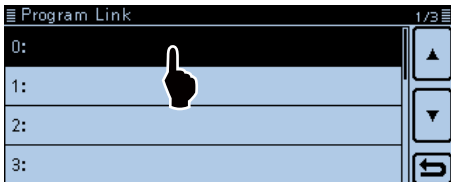

- ② Touch "Edit Name."
• Displays the name edit screen.

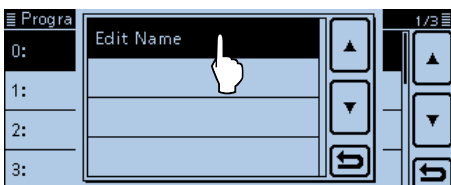

- ③ Touch the keypad.
• Enters the desired character or symbol.
• In the Alphabet entry mode, touch "⇧" to enter an upper case letter once, or touch "⇧" to continuously enter upper case letters. Touch "⇩" to enter lower case letters.
• Touch [[ab]] or [[12]], and then touch [ab], [12] or [(!"#)] to select the desired entry mode.

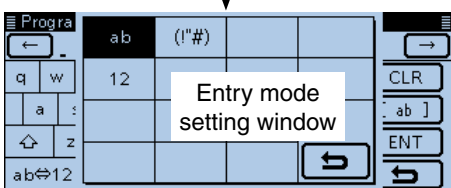
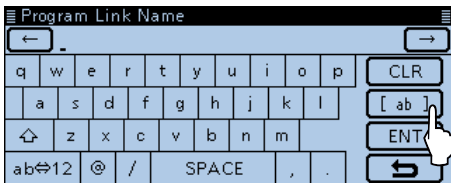

- Touch "ab⇌12" to toggle between the Alphabet entry and Number entry modes.
- Touch "SPACE" to enter a space.
- Touch [CLR] to delete the selected character, symbol or number.
- Touch [QUICK], and then touch "Switch to Tenkey" to switch the keyboard type.

Selectable characters and symbols

A to Z, a to z, 0 to 9, !"#\$%&'()*+,-./:;<=>?@[\]^_`{|}~ (space)

- ④ Touch [←] to move the cursor backwards, or touch [→] to move the cursor forwards.
- ⑤ Repeat steps ③ and ④ to enter a name of up to 16 characters. (Example: Japan)

- ⑥ Touch [ENT] to save the name.

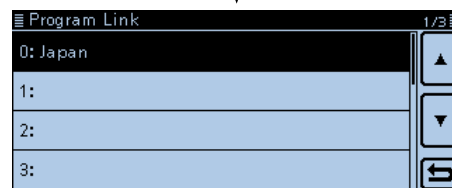

- ⑦ Push [MENU].
• Closes the Menu screen.

Voice Memo items (For Record/Playback)

<<REC Start>>

Voice Memo > QSO Recorder > <<REC Start>>

Touch "<<REC Start>>," and then "Recording started." appears and voice recording starts.

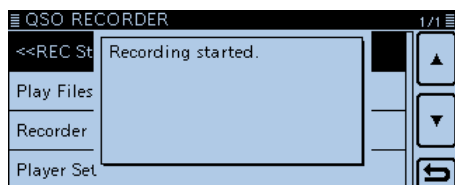

While recording, "<<REC Stop>>" item is displayed. To stop recording, touch "<<REC Stop>>."

- Be sure to insert an SD card into the card slot.
- Once recording has started, the recording will continue, even if the transceiver is rebooted.
- To stop the recording, touch "<<REC Stop>>."

Play Files

Voice Memo > QSO Recorder > Play Files

Performs the following steps to play back the recorded audio on the SD card.

Touch "Play Files" to display the folders on the SD card.

- These folders contain the stored files.

⚡ Be sure to insert an SD card into the card slot.

Playing back

- ① Touch the folder that includes the desired file to play back.
- ② Touch the file to play back.
 - The "VOICE PLAYER" screen is displayed and the selected file is played back.
 - See "Operation while playing back" for forwarding or rewinding. (Section 10)
- ③ Push [MENU].
 - Closes the Menu screen.

NOTE:

- The folder name is automatically created, as shown in the example below:
Recording date is 2014/4/1
Folder name: 20140401
- The file name is automatically created, as shown in the example below:
Recording date and time is 2014/4/1 15:30:00
Folder name: 20140401_153000
- The voice audio is recorded onto an SD card, and saved in the "wav" format. ("wav," is not displayed on the transceiver's screen.)
- The recorded voice audio can also be played back with a PC.

REC Mode

(Default: TX&RX)

Voice Memo > QSO Recorder > Recorder Set > REC Mode

Records both the transmitted and received audio as the default setting.

- TX&RX: Records both the transmitted and received voice audio.
- RX Only: Records only the received voice audio.

When transmitted while recording

When "OFF" is selected in File Split, the recording is paused. After finishing the transmission, the recording resumes.

When "ON" is selected in File Split, a new file is automatically created, and the transmitted voice audio is recorded into the new one.

RX REC Condition (Default: Squelch Auto)

Voice Memo > QSO Recorder > Recorder Set > RX REC Condition

Select whether or not the squelch status affects the RX voice audio recording.

- Always: The transceiver always records the RX voice audio regardless of the squelch status.
- Squelch Auto: The transceiver records the RX voice audio only when a signal is received (the squelch is opened).
When the squelch closes while recording, the recording will continue for 2 seconds, and then pause.

Voice Memo items (Continued)

File Split (Default: ON)

Voice Memo > QSO Recorder > Recorder Set > File Split

Turn the File Split function ON or OFF.

- **OFF:** When the recording starts, a new file is automatically created in the folder on the SD card. The voice audio is continuously recorded into the file, even if transmission and reception, or the squelch status (open and close) is switched. If the file size exceeds 2 GB, a new file is automatically created in the same folder, and the voice audio is recorded there.
- **ON:** When the recording starts, a new file is automatically created in the folder of the SD card. During recording, and if transmission and reception, or squelch status (open and close) is switched, a new file is automatically created in the same folder, and the voice audio is saved into the new one.

PTT Auto REC (Default: OFF)

Voice Memo > QSO Recorder > Recorder Set > PTT Auto REC

Turn the PTT Automatic Recording function ON or OFF.

The transmission from the Bluetooth® VOX function and CI-V command also starts recording.

- **OFF:** Turns OFF the function.
- **ON:** The recording automatically starts when [PTT] is pushed.
The recording will stop when:
 - No signal is transmitted for 10 seconds after releasing [PTT].
 - No signal is received for 10 seconds after releasing [PTT].
 - When transceiver receives a signal in 10 seconds after releasing [PTT], the recording automatically starts.
 - In the AM mode, and when you operate with the squelch opens, the recording automatically stops after 10 minutes.
 - Frequency or operating mode is changed after releasing [PTT].

Skip Time (Default: 10sec)

Voice Memo > QSO Recorder > Player Set > Skip Time

Select the SkipTimer to 3, 5, 10 or 30 seconds to rewind or skip forward for this set period when you push the fast-rewind or fast-forward key while playing the recorded voice audio.

- See “Playing back the recorded audio” for forwarding or rewinding details. (p. 10-3)

DV Auto Reply

Voice Memo > DV Auto Reply

Up to 10 seconds of audio can be recorded for the automatic reply function.

⚡ Be sure to insert an SD card into the transceiver.

- See “Automatic Reply function” for details. (p. 7-12)

Voice TX items

Record

Voice TX > Record

Up to one minute of audio can be recorded onto an SD card for voice transmission. (p. 13-2)

Four independent voice audios can be memorized into each memory T1 to T4.

While recording a QSO voice audio, this function is disabled.

⚡ Be sure to insert an SD card into the card slot.

Repeat Time (Default: 5sec)

Voice TX > TX Set > Repeat Time

Set the repeat time period to between 1 and 15 seconds (in 1 second steps).

The transceiver repeatedly transmits the recorded voice audio for this set time period.

NOTE:

The recorded voice audio is repeatedly transmitted for up to 10 minutes.

If 10 minutes passes while transmitting, the transceiver continues to transmit until the complete voice audio transmission is finished.

TX Monitor (Default: ON)

Voice TX > TX Set > TX Monitor

Turn the TX Monitor function ON or OFF.

- OFF: The TX voice audio is not heard from the speaker.
- ON: The TX voice audio is heard from the speaker.

<<TX>>

Voice TX > TX Set > <<TX>>

The transceiver transmits the recorded voice audio.

Touch the "Repeat TX" box to make a check mark to repeatedly transmit the recorded voice audio for up to 10 minutes, at the specified interval in the Repeat Time item. (p. 13-3)

NOTE:

- If 10 minutes passes while transmitting, the transceiver continues to transmit until the complete voice audio transmission is finished.
- Any one of the following action will cancel the transmission.
 - Push [PTT].
 - Turn OFF the power, then turn it ON again.
 - Push any key (except for [VOL] and [⏻]).

GPS items

GPS Select (Default: Internal GPS)

GPS > GPS Set > GPS Select

Select either the internal GPS receiver that the transceiver receives its position data from or to manually enter your current position data.

- OFF: A GPS receiver is not used.
- Internal GPS: Position data from the internal GPS data is used for the GPS functions.
- Manual: Manually enter the current Latitude, Longitude and Altitude in Manual Position.

Manual Position

(Default: LATITUDE : 0°00'00"N
LONGITUDE : 0°00'00"E
ALTITUDE : -----ft)

GPS > GPS Set > Manual Position

Manually enter the latitude, longitude and Altitude of your current position.

▨ The received position data can be captured by selecting "Capture From GPS" when position data is received from the internal. (p. 8-21)

GPS Out (To DATA jack) (Default: OFF)

GPS > GPS Set > GPS Out (To DATA Jack)

Select whether or not GPS information from the internal GPS receiver is output to the [DATA] jack.

✓ For your information

GPS information is not output from the [DATA] jack when "GPS Select" is set to "OFF" or "Manual."

Select "OFF" when you want to operate slow-speed data communication.

GPS TX Mode (Default: OFF)

GPS > GPS TX Mode

Select a GPS transmission mode to send a GPS data while in the DV mode.

- OFF: Does not transmit a GPS data.
- D-PRS: Transmits GPS data in the D-PRS format.
- NMEA: Transmits a GPS data in the NMEA format.

Unproto Address (Default: API510,DSTAR*)

GPS > GPS TX Mode > D-PRS > Unproto Address

Enter an unproto address of up to 56 alphanumeric characters.

TX Format (Default: Position)

GPS > GPS TX Mode > D-PRS > TX Format

Select the format to transmit the position data in the D-PRS mode.

- Position: The caller station is the mobile or base station.
- Object: Transmits a certain location's information, such as an event, earthquake, and so on.
- Item: Transmits repeater or antenna information that needs no time information.
- Weather: Transmits weather information received from a weather device.

For users who have one of the following models:
(ID-800H, IC-91AD/E91, IC-U82, IC-V82, IC-7100, ID-51A/E, ID-31A/E, IC-9100, IC-80AD/E80D, ID-880H/E880, IC-92AD/E92D, IC-2820H/E2820)
When you receive a D-PRS position (Base), Object, Item or Weather signal, position data will not be displayed.

Symbol (Default: Car)

GPS > GPS TX Mode > D-PRS > TX Format > Position > Symbol

The symbol is an icon which represents your means of transportation or location. The stored symbol in the selected channel (1 to 4) is transmitted with position data while in the D-PRS mode.

Editing a symbol

- ① Touch a desired symbol channel between 1 and 4 for 1 second.
- ② Touch "Edit Symbol."
- ③ Touch [QUICK].
- ④ Touch "Direct Input."
- ⑤ Touch [+] or [-] to select the first digit.
 - Usable characters: /, \, 0 to 9, A to Z
- ⑥ Touch [+] or [-] to select the second digit.
 - Usable characters: Alphanumeric characters and symbols
- ⑦ Touch [SET].
 - Sets the Symbol into the channel selected in step ①.

Selecting a preset symbol

- ① Touch a desired symbol channel between 1 and 4 for 1 second.
- ② Touch "Edit Symbol."
- ③ Touch a desired Symbol.
 - Touch [▲] or [▼] one or more times to select the page.
 - Sets the Symbol into the channel selected in step ①.

GPS items (Continued)

Symbol list

Symbol No.1 1/19

- [1] Sheriff
- [#] Digipeater
- [&] Gateway
- [^] Small Aircraft

Symbol No.1 8/19

- [^] DF station
- [^] Large Aircraft
- [^] WX Station
- [^] Dish Antenna

Symbol No.1 15/19

- [w] Overlaid WX Service
- [v] Radio
- [IV] Icom Radio
- [^] Aircraft

Symbol No.1 2/19

- [+] Red Cross
- [^] House QTH (VHF)
- [X] X
- [.] Red Dot

Symbol No.1 9/19

- [a] Ambulance
- [b] Bicycle
- [f] Fire Truck
- [g] Glider

Symbol No.1 16/19

- [~] Overlaid WX Station
- [a] Overlaid Diamond
- [c] RACES
- [g] Gale Flags

Symbol No.1 3/19

- [f] Fire
- [^] Campground
- [c] Motorcycle
- [=] Railroad Engine

Symbol No.1 10/19

- [h] Hospital
- [j] Jeep
- [k] Truck
- [n] Node

Symbol No.1 17/19

- [h] Ham Store
- [j] Work Zone
- [m] Speedpost(Value Signpost)
- [n] Triangle

Symbol No.1 4/19

- [>] Car
- [<] Canoe
- [E] Eyeball
- [K] School

Symbol No.1 11/19

- [p] Rover
- [r] Repeater
- [s] Ship(powerboat)
- [u] Truck(18-wheeler)

Symbol No.1 18/19

- [o] Small Circle
- [s] Overlaid Ship
- [t] Tornado
- [u] Overlaid Truck

Symbol No.1 5/19

- [L] PC User
- [0] Balloon
- [P] Police
- [R] Recreational Vehicle

Symbol No.1 12/19

- [v] Van
- [^] Yagi @ QTH
- [#] Overlaid Digipeater
- [&] Overlaid Gateway

Symbol No.1 19/19

- [w] Overlaid Van
- [x] Wreck
- [^] Other

Symbol No.1 6/19

- [S] Shuttle
- [T] SSTV
- [U] Bus
- [V] ATV

Symbol No.1 13/19

- [~] House (HF)
- [.] Big Question Mark
- [O] Circle
- [t] Park/Picnic Area

Symbol No.1 7/19

- [w] WX Service
- [X] Helicopter
- [Y] Yacht
- [E] Person

Symbol No.1 14/19

- [>] Overlaid Car
- [L] Lighthouse
- [S] Satellite
- [W] Sunny

GPS items (Continued)

SSID (Default: ---)

GPS > GPS TX Mode > D-PRS > TX Format > Position > SSID

Select an SSID based on APRS® to add to your call sign, to show your operating style to other stations. The addition methods of the SSID may differ, depending on whether the call sign includes a space or not.

- ---: The space in the call sign is converted to “-.”
If no text is programmed after the space, the space will be deleted, and the space is not converted to “-.”
Example: “JA3YUA” ⇒ “JA3YUA”
 “JA3YUA A” ⇒ “JA3YUA-A”
- (-0): No SSID is added.
If a call sign includes a space, any text or digit after the space will be deleted.
Example: “JA3YUA” ⇒ “JA3YUA”
 “JA3YUA A” ⇒ “JA3YUA”
- -1 to -15: Adds an SSID of -1 to -15 to the call sign.
If a call sign includes a space, it will be automatically changed to this set numeric ID.
Example (SSID [-9]):
 “JA3YUA” ⇒ “JA3YUA-9”
 “JA3YUA A” ⇒ “JA3YUA-9”
- -A to -Z: Adds an SSID of -A to -Z to your call sign.
If a call sign includes a space, it will be automatically changed to this set letter ID.
Example (SSID [-Z]):
 “JA3YUA” ⇒ “JA3YUA-Z”
 “JA3YUA A” ⇒ “JA3YUA-Z”

About SSID

To assist in identifying a station’s type, designated call sign SSIDs are used in D-PRS (APRS®), according to the common guideline.

The guideline may be changed when the infrastructure environment, such as a product or network, is changed.

Please check the latest guideline on the web site related on the D-PRS or APRS®, and correctly set.

Comment

GPS > GPS TX Mode > D-PRS > TX Format > Position > Comment

Enter a comment to transmit in addition to the position data.

You can enter up to four comments.

The number of characters you can enter differs, depending on the Data Extension and Altitude settings.

Data Extension	Altitude	Characters entered (maximum)
OFF	OFF	43 (Default)
OFF	ON	35
Course/Speed	OFF	36
Course/Speed	ON	28
Power/Height/Gain/Directivity	OFF	36
Power/Height/Gain/Directivity	ON	28

The symbol “J” shows the transmittable comment range. Please note that the characters that exceed the range will not be transmitted.

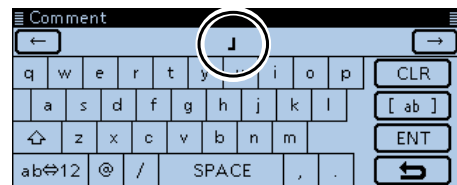

Transmittable comment range display (In case of up to 28 characters)

Time Stamp (Default: OFF)

GPS > GPS TX Mode > D-PRS > TX Format > Position > Time Stamp

Sets the transmitting time stamp type to DHM, HMS or OFF.

The time stamp is transmitted in addition to the position data in the D-PRS mode, and UTC (Universal Time Coordinated) time is used.

- OFF: No time stamp is transmitted.
- DHM: Transmits the time stamp in the Day, Hour, and Minute format.
- HMS: Transmits the time stamp in the Hour, Minute, and Second format.

When your location is manually set, the time stamp data will not be transmitted.

GPS items (Continued)

Altitude (Default: OFF)

GPS > GPS TX Mode > D-PRS > TX Format > Position > Altitude

Select whether or not to transmit the altitude data in addition to the position data in the D-PRS mode.

- OFF: No altitude data is transmitted.
- ON: Transmits altitude data in addition to position data.

/// The number of enterable characters on "Comment" differ, depending on the "Data Extension" and "Altitude" settings.

Data Extension (Default: OFF)

GPS > GPS TX Mode > D-PRS > TX Format > Position > Data Extension

Select whether or not to transmit the course and speed data or Power/Height/Gain/Directivity data in addition to the position data in the D-PRS mode.

- OFF: Transmits only the position data.
- Course/Speed: Transmits the course and speed data in addition to the position data. The course and speed data will not be transmitted when your position is manually set. When transmitting with this setting, your station is regarded as a vehicle station.

- Power/Height/Gain/Directivity: Transmits the programmed Power, Height, Gain, and Directivity data in addition to the position data when your position is manually set. When transmitting with this setting, your station is regarded as a base station. Icom transceivers (IC-7100, ID-51A/E, ID-31A/E, IC-9100, IC-80AD/E80D, ID-880H/E880, IC-92AD/E92D, IC-2820H/E2820, ID-800H, IC-91AD/IC-E91, IC-U82, IC-V82) cannot receive signals with this setting, so they cannot receive Power, Height, Gain and Directivity data.

/// The number of characters you can enter in "Comment" differs, depending on the "Data Extension" and "Altitude" settings.

Power (Default: 0W)

GPS > GPS TX Mode > D-PRS > TX Format > Position > Power

Select the TX power level of the base station, to transmit in addition to the position data.

Select between 0, 1, 4, 9, 16, 25, 36, 49, 64, and 81W.

/// When the "Data Extension" item is set to "Power/Height/Gain/Directivity," this item appears.

Height (Default: 10ft)

GPS > GPS TX Mode > D-PRS > TX Format > Position > Height

Select the height of the base station's antenna, to transmit in addition to the position data.

Select between 10, 20, 40, 80, 160, 320, 640, 1280, 2560, and 5120 feet.*

*If the Altitude/Distance unit is set to "m," select between 3, 6, 12, 24, 49, 98, 195, 390, 780, and 1561 meters.

/// When the "Data Extension" item is set to "Power/Height/Gain/Directivity," this item appears.

Gain (Default: 0dB)

GPS > GPS TX Mode > D-PRS > TX Format > Position > Gain

Select the gain of the base station's antenna, to transmit in addition to the position data.

Select between 0 and 9 dB.

/// When the "Data Extension" item is set to "Power/Height/Gain/Directivity," this item appears.

Directivity (Default: Omni)

GPS > GPS TX Mode > D-PRS > TX Format > Position > Directivity

Select the direction the base station's antenna was pointing, to transmit in addition to the position data.

Select between Omni, 45°NE, 90°E, 135°SE, 180°S, 225°SW, 270°W, 315°NW and 360°N.

/// When the "Data Extension" item is set to "Power/Height/Gain/Directivity," this item appears.

GPS items (Continued)

Object Name

GPS > GPS TX Mode > D-PRS > TX Format > Object > Object Name

Enter an object station name of up to 9 characters.

Data Type (Default: Live Object)

GPS > GPS TX Mode > D-PRS > TX Format > Object > Data Type

Set the object station's status.

Live Object: The object station is valid.

Killed Object: The object station is invalid.

Symbol (Default: Radio)

GPS > GPS TX Mode > D-PRS > TX Format > Object > Symbol

The symbol is an icon which represents object station's means of transportation or location. The stored symbol is transmitted in addition to the position data while in the D-PRS mode.

Editing a symbol

- ① In the "Symbol" screen, touch [QUICK].
- ② Touch "Direct Input."
- ③ Touch [+] or [-] to select the first digit.
 - Usable characters: /, \, 0 to 9, A to Z
- ④ Touch [+] or [-] to select the second digit.
 - Usable characters: Alphanumeric characters and symbols
- ⑤ Touch [SET].
 - Sets the Symbol.

Selecting a preset symbol

- In the "Symbol" screen, touch a desired Symbol.
 - Touch [▲] or [▼] one or more times to select the page.
 - Sets the Symbol.

See page 12-21 for details of the symbol list.

Comment

GPS > GPS TX Mode > D-PRS > TX Format > Object > Comment

Enter a comment.

The number of characters you can enter differs, depending on the Data Extension and Altitude data entry.

Data Extension	Altitude	Characters entered (maximum)
OFF	—	43 (Default)
OFF	Entered	35
Course/Speed	—	36
Course/Speed	Entered	28
Power/Height/Gain/Directivity	—	36
Power/Height/Gain/Directivity	Entered	28

The symbol "J" shows the transmittable comment range. Please note that the characters that exceed the range will not be transmitted.

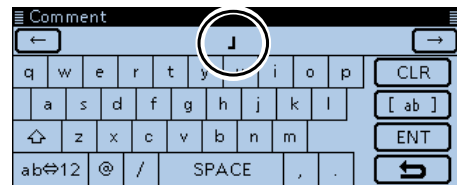

Transmittable comment range display (In case of up to 28 characters)

GPS items (Continued)

Position

GPS > GPS TX Mode > D-PRS > TX Format > Object > Position

Displays the position information of the object station. Touch [QUICK] to display the edit setting window.

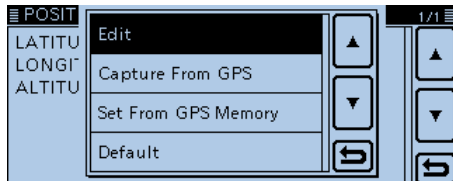

- When the position data is programmed in the GPS memory, touch “Set From GPS Memory” to set the object’s position from the memory. (p. 8-21)
- When the “GPS Select” item is set to “Internal GPS,” and receives your position from the internal GPS receiver, touch “Capture From GPS” to capture your current position from the receiver and set it as the object’s position. (p. 8-21)

Manually enter the position data:

- ① In the Quick Menu window, touch “Edit.”
 - Opens the “POSITION EDIT” screen.
- ② Touch “LATITUDE.”
 - Opens the latitude edit screen.
- ③ Enter the latitude.
 - Touch “N/S” to toggle between north and south.
- ④ Touch [ENT].
- ⑤ Touch “LONGITUDE.”
 - Opens the longitude edit screen.
- ⑥ Enter the longitude.
 - Touch “E/W” to toggle between east and west.
- ⑦ Touch [ENT].
- ⑧ Touch “ALTITUDE.”
 - Opens the altitude edit screen.
- ⑨ Enter the altitude.
 - After entering a digit, touch “+/-” to toggle between plus and minus.
- ⑩ Touch [ENT].
- ⑪ Touch [<<Write>>].
 - Opens the “Write?” window.
- ⑫ Touch [YES].
 - Programs the entered position data.

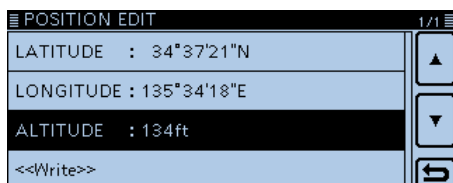

After entering a latitude, longitude and altitude.

/// The number of characters you can enter on “Comment” differs, depending on the “Data Extension” and “Altitude” settings.

Data Extension

(Default: OFF)

GPS > GPS TX Mode > D-PRS > TX Format > Object > Data Extension

Select whether or not to transmit the course and speed data or Power/Height/Gain/Directivity data in addition to the position data in the D-PRS mode.

- OFF: Transmits only the position data.
- Course/Speed: Transmits the course and speed data in addition to the position data.
- Power/Height/Gain/Directivity: Transmits the programmed Power, Height, Gain and Directivity data in addition to the position data.

/// The number of characters you can enter in “Comment” differs, depending on the “Data Extension” and “Altitude” settings.

Course

(Default: 0°)

GPS > GPS TX Mode > D-PRS > TX Format > Object > Course

Set the object station’s course to between 0° and 360°.

/// When the “Data Extension” item is set to “Course/Speed,” this item appears.

Speed

(Default: 0mph)

GPS > GPS TX Mode > D-PRS > TX Format > Object > Speed

Set the object station’s speed to between 0 and 1150 mph.*

*If the Speed unit is set to “km/h,” select between 0 to 1850 km/h, or set to “knots,” select between 0 and 999 knot. (p. 8-21)

/// When the “Data Extension” item is set to “Course/Speed,” this item appears.

GPS items (Continued)

Power (Default: 0W)

GPS > GPS TX Mode > D-PRS > TX Format > Object > Power

Select the TX power level of the object station, to transmit in addition to the position data.

Select between 0, 1, 4, 9, 16, 25, 36, 49, 64, and 81W.

When the "Data Extension" item is set to "Power/Height/Gain/Directivity," this item appears.

Height (Default: 10ft)

GPS > GPS TX Mode > D-PRS > TX Format > Object > Height

Select the height of the object station's antenna, to transmit in addition to the position data.

Select between 10, 20, 40, 80, 160, 320, 640, 1280, 2560, and 5120 feet.*

*If the Altitude/Distance unit is set to "m," select between 3, 6, 12, 24, 49, 98, 195, 390, 780, and 1561 meters.

When the "Data Extension" item is set to "Power/Height/Gain/Directivity," this item appears.

Gain (Default: 0dB)

GPS > GPS TX Mode > D-PRS > TX Format > Object > Gain

Select the gain of the object station's antenna, to transmit in addition to the position data.

Select between 0 and 9 dB.

When the "Data Extension" item is set to "Power/Height/Gain/Directivity," this item appears.

Directivity (Default: Omni)

GPS > GPS TX Mode > D-PRS > TX Format > Object > Directivity

Select the direction the object station's antenna was pointing, to transmit in addition to the position data.

Select between Omni, 45°NE, 90°E, 135°SE, 180°S, 225°SW, 270°W, 315°NW and 360°N.

When the "Data Extension" item is set to "Power/Height/Gain/Directivity," this item appears.

SSID (Default: ---)

GPS > GPS TX Mode > D-PRS > TX Format > Object > SSID

Select an SSID based on APRS® to add to your call sign, to show your operating style to other stations.

The addition methods of the SSID may differ, depending on whether the call sign includes a space or not.

- ---: The space in the call sign is converted to "-." If no text is programmed after the space, the space will be deleted, and the space is not converted to "-." Example: "JA3YUA" ⇒ "JA3YUA" "JA3YUA A" ⇒ "JA3YUA-A"
- (-): No SSID is added. If a call sign includes a space, any text or digit after the space will be deleted. Example: "JA3YUA" ⇒ "JA3YUA" "JA3YUA A" ⇒ "JA3YUA"
- -1 to -15: Adds an SSID of -1 to -15 to the call sign. If a call sign includes a space, it will be automatically changed to this set numeric ID. Example (SSID [-9]): "JA3YUA" ⇒ "JA3YUA-9" "JA3YUA A" ⇒ "JA3YUA-9"
- -A to -Z: Adds an SSID of -A to -Z to your call sign. If a call sign includes a space, it will be automatically changed to this set letter ID. Example (SSID [-Z]): "JA3YUA" ⇒ "JA3YUA-Z" "JA3YUA A" ⇒ "JA3YUA-Z"

About SSID

To assist in identifying a station's type, designated call sign SSIDs are used in D-PRS (APRS®), according to the common guideline.

The guideline may be changed when the infrastructure environment, such as a product or network, is changed.

Please check the latest guideline in the web site related on the D-PRS or APRS®, and correctly set.

Time Stamp (Default: DHM)

GPS > GPS TX Mode > D-PRS > TX Format > Object > Time Stamp

Sets the transmitting time stamp type to DHM or HMS. The time stamp is transmitted in addition to the position data in the D-PRS mode, and UTC (Universal Time Coordinated) time is used.

- DHM: Transmits the time stamp in the Day, Hour, and Minute format.
- HMS: Transmits the time stamp in the Hour, Minute, and Second format.

GPS items (Continued)

Item Name

GPS > GPS TX Mode > D-PRS > TX Format > Item > Item Name

Enter an item station name of up to 9 characters.

Data Type (Default: Live Item)

GPS > GPS TX Mode > D-PRS > TX Format > Item > Data Type

Set the item station's status.

Live Item: The item station is valid.

Killed Item: The item station is invalid.

Symbol (Default: Radio)

GPS > GPS TX Mode > D-PRS > TX Format > Item > Symbol

The symbol is an icon which represents item station's means of transportation or location. The stored symbol is transmitted in addition to the position data while in the D-PRS mode.

Editing a symbol

- ① In the "Symbol" screen, touch [QUICK].
- ② Touch "Direct Input."
- ③ Touch [+] or [-] to select the first digit.
 - Usable characters: /, \, 0 to 9, A to Z
- ④ Touch [+] or [-] to select the second digit.
 - Usable characters: Alphanumeric characters and symbols
- ⑤ Touch [SET].
 - Sets the Symbol.

Selecting a preset symbol

- In the "Symbol" screen, touch a desired Symbol.
 - Touch [▲] or [▼] one or more times to select the page.
 - Sets the Symbol.

See page 12-21 for details of the symbol list.

Comment

GPS > GPS TX Mode > D-PRS > TX Format > Item > Comment

Enter a comment.

The number of characters you can enter differs, depending on the Data Extension and Altitude data entry.

Data Extension	Altitude	Characters entered (maximum)
OFF	—	43 (Default)
OFF	Entered	35
Course/Speed	—	36
Course/Speed	Entered	28
Power/Height/Gain/Directivity	—	36
Power/Height/Gain/Directivity	Entered	28

The symbol "J" shows the transmittable comment range. Please note that the characters that exceed the range will not be transmitted.

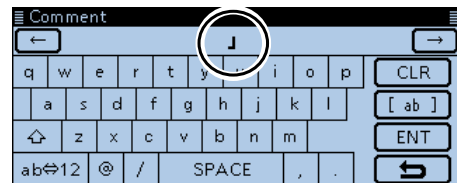

Transmittable comment range display (In case of up to 28 characters)

GPS items (Continued)

Position

GPS > GPS TX Mode > D-PRS > TX Format > Item > Position

Displays the position information of the item station. Touch [QUICK] to display the edit setting window.

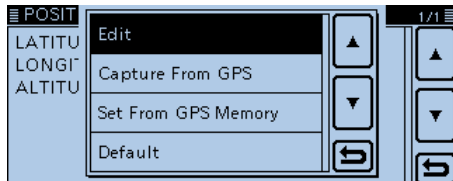

- When the position data is programmed in the GPS memory, touch “Set From GPS Memory” to set the item’s position from the memory. (p. 8-21)
- When the “GPS Select” item is set to “Internal GPS,” and receives your position from the internal GPS receiver, touch “Capture From GPS” to capture your current position from the receiver and set it as the item’s position. (p. 8-21)

Manually enter the position data:

- ① In the Quick Menu window, touch “Edit.”
 - Opens the “POSITION EDIT” screen.
- ② Touch “LATITUDE.”
 - Opens the latitude edit screen.
- ③ Enter the latitude.
 - Touch “N/S” to toggle between north and south.
- ④ Touch [ENT].
- ⑤ Touch “LONGITUDE.”
 - Opens the longitude edit screen.
- ⑥ Enter the longitude.
 - Touch “E/W” to toggle between east and west.
- ⑦ Touch [ENT].
- ⑧ Touch “ALTITUDE.”
 - Opens the altitude edit screen.
- ⑨ Enter the altitude.
 - After entering a digit, touch “+/-” to toggle between plus and minus.
- ⑩ Touch [ENT].
- ⑪ Touch [<<Write>>].
 - Opens the “Write?” window.
- ⑫ Touch [YES].
 - Programs the entered position data.

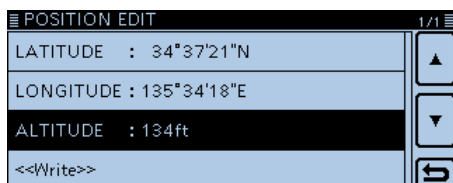

After entering a latitude, longitude and altitude.

/// The number of characters you can enter on “Comment” differs, depending on the “Data Extension” and “Altitude” settings.

Data Extension

(Default: OFF)

GPS > GPS TX Mode > D-PRS > TX Format > Item > Data Extension

Select whether or not to transmit the course and speed data or Power/Height/Gain/Directivity data in addition to the position data in the D-PRS mode.

- OFF: Transmits only the position data.
- Course/Speed: Transmits the course and speed data in addition to the position data.
- Power/Height/Gain/Directivity: Transmits the programmed Power, Height, Gain and Directivity data in addition to the position data.

/// The number of characters you can enter in “Comment” differs, depending on the “Data Extension” and “Altitude” settings.

Course

(Default: 0°)

GPS > GPS TX Mode > D-PRS > TX Format > Item > Course

Set the item station’s course to between 0° and 360°.

/// When the “Data Extension” item is set to “Course/Speed,” this item appears.

Speed

(Default: 0mph)

GPS > GPS TX Mode > D-PRS > TX Format > Item > Speed

Set the item station’s speed to between 0 and 1150 mph.*

*If the Speed unit is set to “km/h,” select between 0 to 1850 km/h, or set to “knots,” select between 0 and 999 knot. (p. 8-21)

/// When the “Data Extension” item is set to “Course/Speed,” this item appears.

GPS items (Continued)

Power (Default: 0W)

GPS > GPS TX Mode > D-PRS > TX Format > Item > Power

Select the TX power level of the item station, to transmit in addition to the position data.

Select between 0, 1, 4, 9, 16, 25, 36, 49, 64, and 81W.

When the "Data Extension" item is set to "Power/Height/Gain/Directivity," this item appears.

Height (Default: 10ft)

GPS > GPS TX Mode > D-PRS > TX Format > Item > Height

Select the height of the item station's antenna, to transmit in addition to the position data.

Select between 10, 20, 40, 80, 160, 320, 640, 1280, 2560, and 5120 feet.*

*If the Altitude/Distance unit is set to "m," select between 3, 6, 12, 24, 49, 98, 195, 390, 780, and 1561 meters.

When the "Data Extension" item is set to "Power/Height/Gain/Directivity," this item appears.

Gain (Default: 0dB)

GPS > GPS TX Mode > D-PRS > TX Format > Item > Gain

Select the gain of the item station's antenna, to transmit in addition to the position data.

Select between 0 and 9 dB.

When the "Data Extension" item is set to "Power/Height/Gain/Directivity," this item appears.

Directivity (Default: Omni)

GPS > GPS TX Mode > D-PRS > TX Format > Item > Directivity

Select the direction that the item station's antenna was pointing, to transmit in addition to the position data.

Select between Omni, 45°NE, 90°E, 135°SE, 180°S, 225°SW, 270°W, 315°NW and 360°N.

When the "Data Extension" item is set to "Power/Height/Gain/Directivity," this item appears.

SSID (Default: ---)

GPS > GPS TX Mode > D-PRS > TX Format > Item > SSID

Select an SSID based on APRS® to add to your call sign, to show your operating style to other stations.

The addition methods of the SSID may differ, depending on whether the call sign includes a space or not.

- ---: The space in the call sign is converted to "-." If no text is programmed after the space, the space will be deleted, and the space is not converted to "-." Example: "JA3YUA" ⇒ "JA3YUA" "JA3YUA A" ⇒ "JA3YUA-A"
- (-): No SSID is added. If a call sign includes a space, any text or digit after the space will be deleted. Example: "JA3YUA" ⇒ "JA3YUA" "JA3YUA A" ⇒ "JA3YUA"
- -1 to -15: Adds an SSID of -1 to -15 to the call sign. If a call sign includes a space, it will be automatically changed to this set numeric ID. Example (SSID [-9]): "JA3YUA" ⇒ "JA3YUA-9" "JA3YUA A" ⇒ "JA3YUA-9"
- -A to -Z: Adds an SSID of -A to -Z to your call sign. If a call sign includes a space, it will be automatically changed to this set letter ID. Example (SSID [-Z]): "JA3YUA" ⇒ "JA3YUA-Z" "JA3YUA A" ⇒ "JA3YUA-Z"

About SSID

To assist in identifying a station's type, designated call sign SSIDs are used in D-PRS (APRS®), according to the common guideline.

The guideline may be changed when the infrastructure environment, such as a product or network, is changed.

Please check the latest guideline in the web site related on the D-PRS or APRS®, and correctly set.

GPS items (Continued)

Symbol (Default: WX Station)

GPS > GPS TX Mode > D-PRS > TX Format > Weather > Symbol

The symbol is an icon which represents weather station's means of transportation or location. The stored symbol is transmitted in addition to the position data while in the D-PRS mode.

Editing a symbol

- ① In the "Symbol" screen, touch [QUICK].
- ② Touch "Direct Input."
- ③ Touch [+] or [-] to select the first digit.
 - Usable characters: /, \, 0 to 9, A to Z
- ④ Touch [+] or [-] to select the second digit.
 - Usable characters: Alphanumeric characters and symbols
- ⑤ Touch [SET].
 - Sets the Symbol.

Selecting a preset symbol

- ➔ In the "Symbol" screen, touch a desired Symbol.
 - Touch [▲] or [▼] one or more times to select the page.
 - Sets the Symbol.

See page 12-21 for details of the symbol list.

SSID (Default: ---)

GPS > GPS TX Mode > D-PRS > TX Format > Weather > SSID

Select an SSID based on APRS® to add to your call sign, to show your operating style to other stations. The addition methods of the SSID may differ, depending on whether the call sign includes a space or not.

- ---: The space in the call sign is converted to "-." If no text is programmed after the space, the space will be deleted, and the space is not converted to "-."
 - Example: "JA3YUA" ➔ "JA3YUA"
 - "JA3YUA A" ➔ "JA3YUA-A"
- (-0): No SSID is added. If a call sign includes a space, any text or digit after the space will be deleted.
 - Example: "JA3YUA" ➔ "JA3YUA"
 - "JA3YUA A" ➔ "JA3YUA"
- -1 to -15: Adds an SSID of -1 to -15 to the call sign. If a call sign includes a space, it will be automatically changed to this set numeric ID.
 - Example (SSID [-9]):
 - "JA3YUA" ➔ "JA3YUA-9"
 - "JA3YUA A" ➔ "JA3YUA-9"

- -A to -Z: Adds an SSID of -A to -Z to your call sign. If a call sign includes a space, it will be automatically changed to this set letter ID.
 - Example (SSID [-Z]):
 - "JA3YUA" ➔ "JA3YUA-Z"
 - "JA3YUA A" ➔ "JA3YUA-Z"

About SSID
 To assist in identifying a station's type, designated call sign SSIDs are used in D-PRS (APRS®), according to the common guideline. The guideline may be changed when the infrastructure environment, such as a product or network, is changed. Please check the latest guideline in the web site related on the D-PRS or APRS®, and correctly set.

Comment

GPS > GPS TX Mode > D-PRS > TX Format > Weather > Comment

Enter a comment of up to 43 characters.

Time Stamp (Default: DHM)

GPS > GPS TX Mode > D-PRS > TX Format > Weather > Time Stamp

Sets the transmitting time stamp type to DHM, HMS or OFF.

The time stamp is transmitted in addition to the position data in the D-PRS mode, and UTC (Universal Time Coordinated) time is used.

- OFF: No time stamp is transmitted.
- DHM: Transmits the time stamp in the Day, Hour, and Minute format.
- HMS: Transmits the time stamp in the Hour, Minute, and Second format.

GPS items (Continued)

GPS Sentence (Default: GGA)

GPS > GPS TX Mode > NMEA > GPS Sentence

Select sentences to be transmitted in the GPS mode to transmit position data.

- Select up to 4 of the 6 GPS sentences to transmit at the same time. RMC, GGA, GLL, VTG, GSA and GSV sentences are selectable.
Even if the GPS Auto TX Timer is set to “5 sec.,” when 4 sentences are selected in this setting, the time the GPS Auto TX Timer will automatically be changed to “10 sec.”
- “VTG,” “GSA” and “GSV” sentences will not be transmitted when your position has been manually set.

NOTE:
Set the GSV sentence to OFF when sending the GPS message to conventional digital transceivers (IC-2820H, IC-E2820, ID-800H, IC-91AD, IC-E91, IC-V82, IC-U82, IC-2200H).
The GSV sentence is incompatible with them. Those transceivers will not display GPS messages properly if sent as a GSV sentence from the ID-5100A/E.

• **Contents of GPS sentence**

The Time Stamp is shown based on the UTC (Universal Time Coordinated) time.

Sentence	Lat/Lon	Alt	GPS Time Stamp (UTC)	Date (UTC)	Status	2D/3D	COG (True)	SOG (knot)
RMC	✓		✓	✓	✓		✓	✓
GGA	✓	✓	✓		✓			
GLL	✓		✓		✓			
VTG							✓	✓
GSA					✓	✓		
GSV								

Sentence	Others
RMC	Magnetic Variation, Mode Indicator
GGA	Number of satellites in use, HDOP, Geoidal separation, Age of Differential GPS data, Differential reference station ID
GLL	Mode Indicator
VTG	COG (Magnetic north), SOG (km/h), Mode Indicator
GSA	PRN number of satellites, PDOP, HDOP, VDOP
GSV	Total number of sentences, Sentence number, Total number of satellites in view, Satellite information (ID, Altitude, Azimuth, S/N)

GPS items (Continued)

GPS Message

GPS > GPS TX Mode > NMEA > GPS Message

Enter a GPS message of up to 20 alphanumeric characters. (p. 8-28)

NOTE: When you do not want to send a message, be sure to delete the message programmed in the Quick Menu window.

GPS Information

GPS > GPS Information

Displays the GPS satellite direction, altitude, satellite number and receiving status. (p. 8-13)

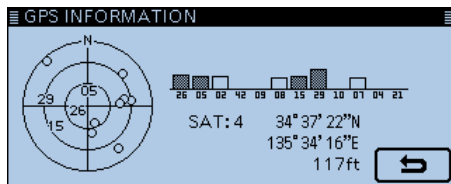

Example: tracking 4 satellites

○	Non tracking satellites
Regular characters (Example: 01)	Tracking satellites (weak signal)
Reversed characters (Example: 01)	Tracking satellites (strong signal)
SAT	Number of tracking satellite
Altitude	-----ft (Non-positioning) / 2D (Tracking three satellite) / Positioning results (4 or more satellite tracking)
Latitude	--°--'--"(Non-positioning)/Positioning results
Longitude	---°--'--"(Non-positioning)/Positioning results

GPS Position

GPS > GPS Position

Your current position, received position or GPS memory alarm position information is displayed. (p. 8-4)
Touch [▲] or [▼] one or more times to select the screen to see the “MY,” “RX,” “MEM” and “ALM” screens.

[MY] screen (MY Position)

Compass*	Displays your direction
Latitude	Displays your latitude
Longitude	Displays your longitude
GL	Displays the grid locator based on the latitude and longitude of your position.
ALT	Displays your own altitude
SPEED	Displays your speed over ground
TIME	Displays current time received from the GPS
COURSE	Displays your direction heading

When the “GPS Select” item is set to “Manual,” the screen shows only latitude, longitude, altitude, GL (Grid locator), and time (internal clock).

[RX] screen (Received position of the other station)

Depending on the caller’s TX mode or TX format, the displayed items and these meanings are differ.

The following lists describe the items for each category.

Nothing is displayed when no position data is received on your transceiver.

1. When the caller’s TX mode is NMEA

Compass*	Displays the caller’s direction from your position.
Latitude	Displays the caller’s latitude
Longitude	Displays the caller’s longitude
GL	Displays the grid locator based on the latitude and longitude of the caller’s position.
ALT	Displays the caller’s altitude
DST	Displays the caller’s distance from your position
COURSE	Displays the caller’s direction over ground
SPEED	Displays the caller’s speed
GPS Time Stamp	Displays the time that the caller acquired the position data.
Call sign	Displays the caller’s call sign

*These items can be selected in the Quick Menu screen.

GPS items (Continued)

2. When the caller's TX format is D-PRS Position (Mobile station)

Compass*	Displays the caller's direction from your position
Latitude	Displays the caller's latitude
Longitude	Displays the caller's longitude
GL	Displays the grid locator based on the latitude and longitude of the caller's position.
ALT	Displays the caller's altitude
DST	Displays the caller's distance from your position
COURSE	Displays the caller's direction over ground
SPEED	Displays the caller's speed
Symbol	Displays the caller's D-PRS symbol
SSID	Displays the caller's SSID
GPS Time Stamp	Displays the time that the caller acquired the position data.
Call sign	Displays the caller's call sign (with SSID)

3. When the caller's TX format is D-PRS Position (Base station)

Compass*	Displays the caller's direction from your position
Latitude	Displays the caller's latitude
Longitude	Displays the caller's longitude
GL	Displays the grid locator based on the latitude and longitude of the caller's position.
ALT	Displays the caller's altitude
DST	Displays the caller's distance from your position
POWER	Displays the caller's TX power level
HEIGHT	Displays the height of caller's antenna
GAIN	Displays the gain of caller's antenna
DIRECT	Displays the direction of caller's antenna was pointing
Symbol	Displays the caller's D-PRS symbol
SSID	Displays the caller's SSID
GPS Time Stamp	Displays the time that the caller acquired the position data.
Call sign	Displays the caller's call sign (with SSID)

4. When the caller's TX format is D-PRS Object/Item

Compass*	Displays the Object/Item station's direction from your position
Latitude	Displays the Object/Item station's latitude
Longitude	Displays the Object/Item station's longitude
GL	Displays the grid locator based on the latitude and longitude of the Object/Item station's position.
ALT	Displays the Object/Item station's altitude
DST	Displays the Object/Item station's distance from your position
COURSE	Displays the Object/Item station's direction over ground
SPEED	Displays the Object/Item station's speed
POWER	Displays the Object/Item station's TX power level
HEIGHT	Displays the height of Object/Item station's antenna
GAIN	Displays the gain of Object/Item station's antenna
DIRECT	Displays the direction that the Object/Item station's antenna was pointing
Symbol	Displays the Object/Item station's D-PRS symbol
SSID	Displays the caller's SSID
GPS Time Stamp	Displays the time that the caller sent the Object station's data.
Call sign	Displays the caller's call sign (with SSID)

/// When the object or item station is disabled, "KILLED" appears.

*These items can be selected in the Quick Menu screen.

GPS items (Continued)

5. When the caller's TX format is D-PRS Weather

Compass*	Displays the caller's direction from your position
Latitude	Displays the caller's latitude
Longitude	Displays the caller's longitude
GL	Displays the grid locator based on the latitude and longitude of the caller station's position
DST	Displays the caller's distance from your position
TEMP	Displays the temperature of the caller station's area
RAIN	Displays the rainfall of the caller station's area
WIND DIR	Displays the wind direction of the caller station's area
WIND SPD	Displays the wind speed of the caller station's area
BARO	Displays the barometric pressure of the caller station's area
HUMI	Displays the humidity of the caller station's area
Symbol	Displays the caller station's D-PRS symbol
SSID	Displays the caller's SSID
GPS Time Stamp	Displays the time that the caller acquired the weather data.
Call sign	Displays the caller's call sign (with SSID)

[MEM] screen (GPS memory alarm position)

Compass*	Displays GPS Memory channel's direction from your position
Latitude	Displays GPS Memory channel's latitude
Longitude	Displays GPS Memory channel's longitude
GL	Displays the grid locator based on the latitude and longitude of GPS Memory channel's.
DST	Displays GPS Memory channel's distance from your position
GPS memory name*	Displays the selected GPS memory name

[ALM] screen (GPS alarm position)

Compass*	Displays GPS Alarm area's direction from your position
Latitude	Displays GPS Alarm area's latitude
Longitude	Displays GPS Alarm area's longitude
GL	Displays the grid locator based on the latitude and longitude of GPS Alarm area's.
DST	Displays GPS Alarm area's distance from your position
GPS Alarm*	Displays "RX," GPS memory group name or GPS memory name specified for the GPS alarm function.

*These items can be selected in the Quick Menu screen.

GPS Memory

GPS > GPS Memory

The transceiver has 200 GPS memory channels to store the received position data, or often-used position data, along with an alphanumeric channel name.

The channels can be divided into the "(No Group)" group and each memory group (A to Z) for easy memory management.

The display of the GPS memory

(No Group)	GPS memories not assigned to any group.
A to Z : Group Name	GPS memories assigned to the selected group.

GPS memory groups (A-Z)

GROUP NAME	GPS memory group name (Up to 16 alphanumeric characters)
------------	--

The GPS memory group name can be edited in the Quick Menu screen. (p. 8-33)

GPS memory channels

NAME	GPS memory channel name (Up to 16 alphanumeric characters)
DATE	Stored date
TIME	Stored time
LATITUDE	Stored location (latitude)
LONGITUDE	Stored location (longitude)
ALTITUDE	Stored altitude
GROUP	The group letter and the name of the group

When you store the received position data in the "GPS Positon" screen, the received station's call sign is used as the GPS memory name. GPS memory contents, such as the GPS memory name, can be edited in the Quick Menu screen. (pp. 8-29 to 8-32)

GPS items (Continued)

Alarm Select (Default: OFF)

GPS > GPS Alarm > Alarm Select

Select the target position(s) for the GPS alarm function.

- OFF: Turns OFF the function.
- RX: When a target (the last received position) enters in your active alarm range, the GPS alarm sounds.
- Group: When a target (positions in the GPS memory, or in the selected GPS memory group) enters in your active alarm range, the GPS alarm sounds.
- Memory: When a target (the specified position in the GPS memory) enters in the active alarm range, the GPS alarm sounds.

Alarm Area (Group) (Default: 0.25')

GPS > GPS Alarm > Alarm Area (Group)

Set the GPS active alarm range.

When the "Alarm Select" item is set to "Group," this setting is enabled.

When a target enters in the specified active alarm range, the GPS alarm sounds and the GPS alarm icon blinks.

The programmable values depend on the setting in Position Format.

- Position Format = ddd°mm.mm' 00.08' to 59.99' (0.01' steps)
- Position Format = ddd°mm'ss" 00'05" to 59'59" (0'01" steps)

Example:

When a target enters in the active alarm range, the GPS alarm sounds and the GPS alarm icon blinks.

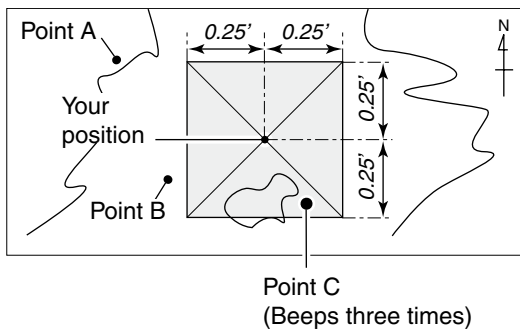

Alarm Area (RX/Memory) (Default: Both)

GPS > GPS Alarm > Alarm Area (RX/Memory)

Select the GPS active alarm range.

When the "Alarm Select" item is set to "RX" or "Memory," this setting is enabled.

When a target enters in the active alarm range, the GPS alarm sounds and the GPS alarm icon blinks.

- Limited : The transceiver sounds 3 beeps and the GPS alarm icon blinks when the target enters the 500 meter range.
- Extended : The transceiver sounds 3 beeps and the GPS alarm icon blinks when the target enters the 1 kilometer range.
- Both : The transceiver sounds a beep and the GPS alarm icon blinks when the target enters the 1 kilometer range, and sounds 3 beeps and the icon blinks when it enters the 500 meter range.
When the target exits the 500 meter range, but is still in the 1 kilometer range, the icon continues to blink, but no beeps sound.

Example:

When a target enters in the active alarm range (500 meter or 1 kilometer range, depending on the setting), the GPS alarm sounds and the GPS alarm icon blinks.

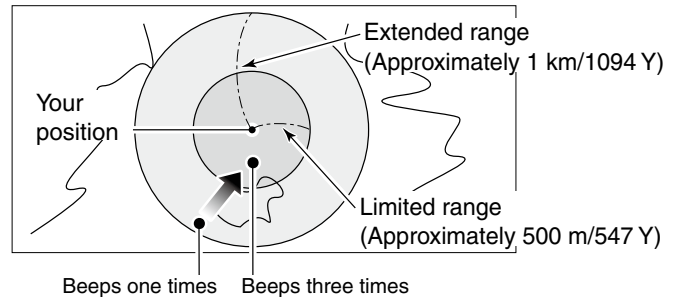

GPS items (Continued)

GPS Logger (Default: OFF)

GPS > GPS Logger > GPS Logger

Turn the GPS Logger function ON or OFF. This function logs the position, altitude, course, speed and number of satellites being used.

- OFF: Turns OFF the function.
- ON: The transceiver automatically logs GPS data. Once this function is turned ON, the GPS data will be continuously logged until turning it OFF, even if the transceiver power is turned OFF, then ON again.

To use this function:

1. You must first insert an SD card into the transceiver.
2. You must select "GPS select" for the "Internal GPS" item.

NOTE:

The log data will be saved on the SD card. The file name is automatically created, as shown in the example:
 Log start date and time: 2014/4/1 15:30:00
 File name: 20140401_153000.log

Record Interval (Default: 5sec)

GPS > GPS Logger > Record Interval

Select the GPS Logger function record interval of 1, 5, 10, 30, or 60 seconds.

GPS Auto TX (Default: OFF)

GPS > GPS Auto TX

Select an option for the GPS automatic transmission function. This function automatically transmits the current position data received from a GPS receiver, as well as any programmed GPS message, at the selected interval.

- OFF: Does not automatically transmit the position data. (When you push [PTT], the transceiver transmits the position data.)
- 5 sec to 30 min: Transmits the current position data at the selected interval (5*, 10, or 30 seconds, or 1, 3, 5, 10, or 30 minutes).
 *Does not appear when you set four GPS sentences in "GPS Sentence."

NOTE: When the GPS transmit mode is "NMEA," set the "GPS Select" item to "Internal GPS." If you set to "Manual" or "OFF," the current position data will not be automatically transmitted.

Call Sign items

Call Sign

Call Sign

Sets or views the “UR,” “R1,” “R2,” and “MY” call signs to use for the DV operation.

When you don't use the DR function in the DV mode, sets the desired call signs in this screen.

For Simplex operation (DV mode)

“UR” and “MY” call signs can be set.

For Duplex (repeater) operation (DV mode/DR function)

Only “MY” call sign can be set when using the DR function.

<To set Duplex (repeater) operation>

Example: Making a gateway CQ call to Inage repeater (JP1YJQ A) from the Hirano repeater (JP3YHH A), in the DV mode.

- Before starting to set the call sign, set the frequency of your access repeater and duplex direction. (See section 7)

For your reference:

When the DR function is ON, the repeater call sign can be automatically set. (p. 12-45)

1. Call sign “R1” setting

- ① In the DV mode, touch “R1” for 1 second.
- ② Touch “Edit.”
- ③ Touch the keypad to enter the first character.
 - Alphanumeric characters and symbol (“/”) can be entered.
- ④ Touch [←] to move the cursor backwards, or touch [→] to move the cursor forwards.
- ⑤ Repeat steps ③ and ④ to enter a name of up to 8 characters, including a spaces.
- ⑥ After entering, touch [ENT].

2. Gateway “R2” setting

- ① Touch “R2.”
- ② Touch “GW.”

To manually enter the call sign, touch “R2” for 1 second in step ①.

About the RPT2 SELECT screen

NOT USED*	For local area call
GW	To select the gateway call sign from the repeater list.
Repeater	To select the repeater that has the same gateway as the “R1” repeater.

3. Destination “UR” setting

- ① Touch “UR.”
- ② Touch “Gateway CQ.”
- ③ Touch “11:Japan” (repeater group where your destination repeater is listed).
- ④ Touch “Inage.”

To manually enter the call sign, touch “UR” for 1 second in step ①.

About the YOUR SELECT screen

CQCQCQ	To select “CQCQCQ” to make a non-call sign specific call.
Gateway CQ†	To select “Gateway CQ” to make a call using the repeater list.
Your Call Sign	To select the destination “UR” call sign using the Your Call Sign memory.
RX History	To select the destination “UR” call sign using the RX History.
TX History	To select the destination “UR” call sign using the TX History.

†Not displayed in the Simplex mode.

RX History items

RX History

RX History

When a call is received in the DV mode, the call information such as the caller station's call sign, the repeater's call sign, and so on, are stored in this screen. Up to 50 records can be stored.

- Even if the transceiver power is turned OFF, the stored records are not deleted.

Touch [▲] or [▼] one or more times to confirm the RX record contents.

Contents of the RX History Top screen

RX01–RX50	RX history number
CALLER*1	Displays the call sign of the caller station and any note programmed after the call sign.
CALLED*1	Displays the call sign of the called station.
MESSAGE	Displays any message included in the received call, if programmed.
RXRPT2*1	Displays the call sign of the repeater you received the call from.
FREQUENCY	Displays the frequency the call was received. (This item appears only when the simplex call is received.)
RX TIME	Displays the date and time the call was received.
[GW]	Appears when a call is received through the internet.
[GPS]	Appears when position data is included. (NMEA or Mobile/Base station)
[OBJ]	Appears when the object's data is included.
[ITEM]	Appears when the item's data is included.
[WX]	Appears when the weather station's data is included.
(UP)	Appears when an uplink signal is received.
RX>CS	Touch to capture the call sign.
DETAIL	Touch to display the detail screen.
Compass*2	Displays the caller's direction from your position.
Distance	Displays the caller's distance from your position.
Symbol	Displays the caller's symbol.

*1 These items can be switched to the Name display.

*2 If you have no position data, these items are not displayed.

*3 These items show the name under the call sign, if programmed.

*4 "FREQUENCY" appears instead of these items when the call was not through a repeater (Simplex call), to show the frequency that was used.

<The contents of the detail screen>

The contents of the detail screen differ, whether the position data is included in the received data or not. The position data that is included in the received data can be divided into five categories. Depending on the caller's TX mode or TX format, the displayed items and these meanings differ.

The following lists show the items for each category.

- Nothing is displayed when no position data is received.

Common items

CALLER*3	Displays the call sign of the caller station and any note programmed after the call sign.
CALLED*3	Displays the call sign of the called station.
RXRPT1*3, *4	Displays the call sign of the repeater that was accessed by the caller station. If it was a call through a gateway and the internet, this item displays the gateway repeater call sign of your local area repeater.
RXRPT2*3, *4	Displays the call sign of the repeater you received the call from.
RX MESSAGE	Displays any message included in the received call, if programmed.
RX TIME	Displays the date and time the call was received.

1. When the caller's TX mode is NMEA

Compass*2	Displays the caller's direction from your position
Latitude	Displays the caller's latitude
Longitude	Displays the caller's longitude
GL	Displays the grid locator based on the latitude and longitude of the caller's position.
ALT	Displays the caller's altitude
DIST*2	Displays the caller's distance from your position
COURSE	Displays the caller's direction over ground
SPEED	Displays the caller's speed
GPS Time Stamp	Displays the time that the caller acquired the position data.
Call sign	Displays the caller's call sign
GPS MESSAGE	Displays the GPS message included in the position data of the received call.

RX History items (Continued)

2. When the caller's TX format is D-PRS Position (Mobile station)

Compass*	Displays the caller's direction from your position
Latitude	Displays the caller's latitude
Longitude	Displays the caller's longitude
GL	Displays the grid locator based on the latitude and longitude of the caller's position.
ALT	Displays the caller's altitude
DIST*	Displays the caller's distance from your position
COURSE	Displays the caller's direction over ground
SPEED	Displays the caller's speed
GPS Time Stamp	Displays the time that the caller acquired the position data.
Call sign	Displays the caller's call sign (with SSID)
Symbol	Displays the caller's D-PRS symbol
GPS MESSAGE	Displays the GPS message included in the position data of the received call.

3. When the caller's TX format is D-PRS Position (Base station)

Compass*	Displays the caller's direction from your position
Latitude	Displays the caller's latitude
Longitude	Displays the caller's longitude
GL	Displays the grid locator based on the latitude and longitude of the caller's position.
ALT	Displays the caller's altitude
DIST*	Displays the caller's distance from your position
POWER	Displays the caller's TX power level
HEIGHT	Displays the height of caller's antenna
GAIN	Displays the gain of caller's antenna
DIRECT	Displays the direction that the caller's antenna was pointing
GPS Time Stamp	Displays the time that the caller acquired the position data.
Call sign	Displays the caller's call sign (with SSID)
Symbol	Displays the caller's D-PRS symbol
GPS MESSAGE	Shows the GPS message included in the position data of the received call.

4. When the caller's TX format is D-PRS Object/Item

Compass*	Displays the Object/Item station's direction from your position
Latitude	Displays the Object/Item station's latitude
Longitude	Displays the Object/Item station's longitude
GL	Displays the grid locator based on the latitude and longitude of the Object/Item station's position.
ALT	Displays the Object/Item station's altitude
DIST*	Displays the Object/Item station's distance from your position
COURSE	Displays the Object/Item station's direction over ground
SPEED	Displays the Object/Item station's speed
POWER	Displays the Object/Item station's TX power level
HEIGHT	Displays the height of Object/Item station's antenna
GAIN	Displays the gain of Object/Item station's antenna
DIRECT	Displays the direction that the Object/Item station's antenna was pointing
GPS Time Stamp	Displays the time that the caller sent the Object station's data.
Call sign	Displays the caller's call sign (with SSID)
Symbol	Displays the Object/Item station's D-PRS symbol
Status	Displays "KILLED" when the object or Item station is disabled.
GPS MESSAGE	Displays the GPS message included in the position data of the received call.

*If you have no position data, these items are not displayed.

RX History items (Continued)

5. When the caller's TX format is D-PRS Weather

Compass*	Displays the caller's direction from your position
Latitude	Displays the caller's latitude
Longitude	Displays the caller's longitude
GL	Displays the grid locator based on the latitude and longitude of the caller's position.
DIST*	Displays the caller's distance from your position
TEMP	Displays the temperature of the caller station's area
RAIN	Displays the rainfall of the caller station's area
WIND DIR	Displays the wind direction of the caller station's area
WIND SPD	Displays the wind speed of the caller station's area
BARO	Displays the barometric pressure of the caller station's area
HUMI	Displays the humidity of the caller station's area
Symbol	Displays the caller's D-PRS symbol
GPS Time Stamp	Displays the time that the caller acquired the position data.
GPS MESSAGE	Shows the D-PRS comment included in the position data of the received call.

*If you have no position data, these items are not displayed.

DV Memory items

Your Call Sign

DV Memory > Your Call Sign

The transceiver has a total of 200 memories to store an individual station destination call sign.

The stored call sign and name are displayed on the "YOUR CALL SIGN" or "RX HISTORY" screen.

- The Your (UR) Call Sign can be programmed to the memory using the RX History. (p. 6-26)
- See pages 7-32 to 7-35 about how to add, edit or move the Your Call Sign in the memory.

Repeater List

DV Memory > Repeater List

You can store repeater information for quick and simple communication when using repeaters.

The transceiver has a total of 1200 repeater memory channels, storable in 30 groups (01 to 30).

NOTE:

For easy operation, a repeater list is preloaded into your transceiver. However, if the CPU clears all programmed contents (All Reset), the repeater list is also cleared.

We recommend that memory data be backed up using an SD card, or be saved to a PC using the CS-5100 cloning software.

About the repeater list:

The repeater list can be downloaded from the Icom website.

<http://www.icom.co.jp/world/support/download/firm/index.html>

Repeater Group (01 to 30)

Group name	Repeater group name of up to 16 alphanumeric characters
------------	---

The Skip setting can be turned ON or OFF in the Quick Menu screen.

Repeater List

<DV Repeater>

TYPE	DV Repeater
NAME	Repeater name of up to 16 alphanumeric characters
SUB NAME	Repeater sub name of up to 8 alphanumeric characters
CALL SIGN	Repeater call sign
GW CALL SIGN	Gateway call sign
GROUP	Repeater group where the repeater is assigned
USE(FROM)	Select whether or not to use the repeater as an access repeater (FROM) in the DR screen
FREQUENCY	Operating frequency of the access repeater
DUP	Duplex setting to use the access repeater
OFFSET FREQ	Frequency offset to use the access repeater
POSITION	Position data accuracy level ("None," "Approximate" or "Exact")
LATITUDE*	Latitude position of the repeater
LONGITUDE*	Longitude position of the repeater
UTC OFFSET	Time difference between UTC (Universal Time Coordinated) and the local time

- **NOTE:** When the repeater is used for a simplex communication, refer to the list below to set the settings.

<DV Simplex>

TYPE	DV Simplex
NAME	Enter the desired name of up to 16 alphanumeric characters
SUB NAME	Enter the desired sub name of up to 8 alphanumeric characters
GROUP	Set the desired repeater group
USE(FROM)	Select whether or not to use the repeater as an access repeater (FROM) in the DR screen
FREQUENCY	Frequency to operate simplex
POSITION	Position data accuracy level ("None," "Approximate" or "Exact")
LATITUDE*	Latitude position of the access point
LONGITUDE*	Longitude position of the access point
UTC OFFSET	Time difference between UTC (Universal Time Coordinated) and the local time

* Appears when POSITION is set to "Approximate" or "Exact."

DV Memory items (Continued)

<FM Repeater>

TYPE	FM repeater
NAME	FM repeater name of up to 16 alphanumeric characters
SUB NAME	FM repeater sub name of up to 8 alphanumeric characters
CALL SIGN	FM repeater call sign
GROUP	Repeater group where the repeater is assigned
USE(FROM)	Select whether or not to use the FM repeater as an access repeater (FROM) in the DR screen
FREQUENCY	Operating frequency of the FM repeater
DUP	Duplex setting to use the FM repeater
OFFSET FREQ	Frequency offset to use the FM repeater
MODE	Receiving mode of the FM repeater
TONE	Tone function setting of the FM repeater
REPEATER TONE	FM repeater tone frequency (Tone Encoder) setting of the access repeater.
POSITION	Position data accuracy level ("None," "Approximate" or "Exact")
LATITUDE*	Latitude position of the FM repeater
LONGITUDE*	Longitude position of the FM repeater
UTC OFFSET	Time difference between UTC (Universal Time Coordinated) and the local time

<FM Simplex>

TYPE	FM Simplex
NAME	Enter the desired name of up to 16 alphanumeric characters
SUB NAME	Enter the desired sub name of up to 8 alphanumeric characters
GROUP	Set the desired repeater group
USE(FROM)	Select whether or not to use the access repeater (FROM) in the DR screen
FREQUENCY	Frequency to operate simplex
MODE	Receiving mode for simplex FM
TONE	Tone function setting for simplex FM
REPEATER TONE	FM simplex tone frequency (Tone Encoder) setting of the access repeater
POSITION	Position data accuracy level ("None," "Approximate" or "Exact")
LATITUDE*	Latitude position of the station
LONGITUDE*	Longitude position of the station
UTC OFFSET	Time difference between UTC (Universal Time Coordinated) and the local time

* Appears when POSITION is set to "Approximate" or "Exact."

My Station items

My Call Sign

My Station > My Call Sign

The transceiver has a total of 6 memories to store your own call signs.

A call sign of up to 8 digits can be entered.

Also, a note of up to 4 characters, for operating radio type, area, and so on, can be entered.

- See page 6-5 for MY call sign programming.
- To select a different My Call Sign, touch the desired call sign to set.

TX Message

My Station > TX Message

The transceiver has a total of 5 memories to store short messages for simultaneous transmission in the DV mode.

Enter a message of up to 20 alphanumeric characters for each memory.

- See page 7-2 for TX message entry.
- To changing the TX Message, touch the desired message to select it.
- When no message transmission is desired, select "OFF."

DV Set items

RX Bass (Default: Normal)

DV Set > Tone Control > RX Bass

Set the received audio bass filter level to Cut, Normal or Boost.

- Cut: Reduces the low frequencies
- Normal: Normal tone balance
- Boost: Increases the high frequencies

RX Treble (Default: Normal)

DV Set > Tone Control > RX Treble

Set the received audio treble filter level to Cut, Normal or Boost.

- Cut: Reduces the high frequencies
- Normal: Normal tone balance
- Boost: Increases the high frequencies

RX Bass Boost (Default: OFF)

DV Set > Tone Control > RX Bass Boost

Turn the received audio Bass Boost function ON or OFF.

This function is separate from the "Boost" setting of the RX Bass.

- OFF: Turns OFF the function.
- ON: This function boosts the received audio bass.

TX Bass (Default: Normal)

DV Set > Tone Control > TX Bass

Set the transmit audio bass filter level to Cut, Normal or Boost.

- Cut: Reduces the low frequencies
- Normal: Normal tone balance
- Boost: Increases the low frequencies

TX Treble (Default: Normal)

DV Set > Tone Control > TX Treble (TX Treble)

Set the transmit audio treble filter level to Cut, Normal or Boost.

- Cut: Reduces the high frequencies
- Normal: Normal tone balance
- Boost: Increases the high frequencies

Auto Reply (Default: OFF)

DV Set > Auto Reply

Set the automatic reply function to ON, OFF, Voice, Position (Main Only), or Position (Main/Sub).

This function automatically replies to a call addressed to your own call sign, even if you are away from the transceiver.

- OFF: Turns OFF the function.
- ON: Replies with your own call sign. (No audio reply is sent)
- Voice: Replies with your call sign and any Auto Reply message recorded on the SD (up to 10 seconds).
If no SD card is inserted, or no message is recorded, only your call sign is transmitted. The transmitted audio can be monitored.
- Position (Main Only):
Replies with your own call sign and transmits your position using the internal GPS receiver. In the Dualwatch mode, automatically replies only when the signal is received on the MAIN band.
- When the "GPS Select" item is set to "OFF" or "Manual," the internal GPS receiver is temporarily turned ON.
- Position (Main/Sub):
Replies with your own call sign and transmits your position using the internal GPS receiver. In the Dualwatch mode, automatically replies when the signal is received on either the Main or Sub band.
- When the "GPS Select" item is set to "OFF" or "Manual," the internal GPS receiver is temporarily turned ON.

NOTE:

- When "ON" or "Voice" is selected, the Automatic reply function is automatically turned OFF when you push [PTT].
- When "Position (Main Only)" or "Position (Main/Sub)" is selected, the Automatic reply function is not turned OFF, even if you push [PTT].

DV Data TX (Default: Auto)

DV Set > DV Data TX

Select whether to manually or automatically transmit slow-speed data.

- PTT: Push [PTT] to manually transmit the data.
- Auto: When data is input from a PC through the [DATA] jack, the transceiver automatically transmits it.

DV Set items (Continued)

Digital Monitor (Default: Auto)

DV Set > Digital Monitor

Select a receive mode when [MONI] on the function menu is touched in the DV mode.

- Auto: Receives in the DV mode or the FM mode, depending on the received signal.
- Digital: Receives in the DV mode.
- Analog: Receives in the FM mode.

Digital Repeater Set (Default: ON)

DV Set > Digital Repeater Set

Turn the digital repeater setting function ON or OFF. In any DV mode except when using the DR function, and when accessing a repeater that has a call sign that is different than the transceiver's setting, this function reads the repeater's signal and automatically sets the repeater call sign in R1 and R2.

- OFF: Turns OFF the function.
- ON: Automatically sets the repeater call sign.

DV Auto Detect (Default: OFF)

DV Set > DV Auto Detect

Turn the DV mode automatic detect function ON or OFF.

If you receive an FM signal in the DV mode, this function temporarily switches to the FM mode.

- OFF: Turns OFF the function. The operating mode is fixed to the DV mode.
- ON: Automatically selects the FM mode for temporary operation.

RX Record (RPT) (Default: ALL)

DV Set > RX Record (RPT)

The transceiver can record the data of up to 50 individual calls.

When the received signal includes a status message ("UR?" or "RPT?") that is sent back from the access repeater, you can record up to 50 messages, or only the last call, in the Received Call Record.

- ALL: Records up to 50 calls.
- Latest Only: Records only the last call.

BK (Default: OFF)

DV Set > BK

The BK (Break-in) function allows you to break into a conversation, where the two other stations are communicating with call sign squelch enabled.

- OFF: Turns OFF the function.
- ON: Turns ON the function.

NOTE: The BK function is automatically turned OFF when transceiver is turned OFF.

EMR (Default: OFF)

DV Set > EMR

The EMR communication function can be used in the digital mode. With the EMR function, no call sign setting is necessary.

When you transmit a call with the EMR function, all transceivers that receive an EMR signal automatically open their squelch to receive the signal.

When an EMR signal is received, the audio (voice) will be heard at the specified level, even if the volume is set to a minimum level, or digital call sign or digital code squelch is in use.

- OFF: Turns OFF the function.
- ON: Turns the function ON.

NOTE: The EMR function is automatically turned OFF when transceiver is turned OFF.

EMR AF Level (Default: 19)

DV Set > EMR AF Level

Set the audio output level to between 0 and 32 for when an EMR communication signal is received.

When an EMR signal is received, the audio will be heard at the set level, or the [VOL] control level, whichever is higher.

To disable the setting, set it to "0."

NOTE: After an EMR signal disappears, the audio level will remain at the EMR level. In this case, rotate [VOL] to adjust the audio to a desired level.

SPEECH items

RX Call Sign SPEECH (Default: ON (Kerchunk))

SPEECH > RX Call Sign SPEECH

Turn the RX call sign speech function ON or OFF for calls received in the DV mode.

- OFF: The caller station's call sign is not announced, even when a call is received.
- ON (Kerchunk): The caller station's call sign is announced only when they make a short transmission.
- ON (All): The caller station's call sign is always announced.

NOTE:

- When the digital squelch function is used, the calling station's call sign is not announced if the received signal is not addressed to your call sign, or does not include a matched digital code.
- When you receive a signal from a repeater ("UR?" or "RPT?"), the caller station's call sign is not announced.
- Even if a note is after the call sign, it is not announced.
- When you receive a signal during an announcement, the transceiver cancels announcement, and you can hear the received audio.

RX>CS SPEECH (Default: ON)

SPEECH > RX>CS SPEECH

Turn the RX>CS Speech function ON or OFF.

The RX>CS Speech function announces the station call sign that is selected from a Received Call Record by touching [RX>CS] in the function menu.

- OFF: The station call sign is not announced.
- ON: The station call sign is announced.

NOTE:

- If a call is received during an announcement, the received audio will be muted, and no audio is recorded onto the SD card.
- If the call sign is announced while recording, the recorded contents are silent during the announcement.

DIAL SPEECH (Default: OFF)

SPEECH > DIAL SPEECH

Turn the Dial Speech function ON or OFF.

The Dial Speech function announces the frequency or repeater call sign that is selected by rotating [DIAL].

- OFF: The frequency or repeater call sign is not announced.
- ON: The frequency or repeater call sign is announced, 1 second after rotating [DIAL].
 - In the VFO, Memory and Call channel modes, the frequency is announced.
 - When using the DR function, the repeater call sign is announced. If Simplex is selected, the frequency is announced.
 - When using the DR function, the frequency is announced if the FM repeater does not have a call sign.

NOTE: When you receive a signal during an announcement, the transceiver cancels announcement, and you can hear the received audio.

MODE SPEECH (Default: OFF)

SPEECH > MODE SPEECH

Turn the Operating Mode Speech function ON or OFF. When this function is ON, the selected operating mode is announced.

- OFF: The selected operating mode is not announced.
- ON: The selected operating mode is announced.

NOTE:

- In the DV mode, the recorded contents are silent during the announcement.
- In the AM, AM-N, FM or FM-N mode, the received contents are recorded onto the SD card, if a call is received during an announcement.
- Scanning in the VFO mode, the operating mode is announced if you change the mode.

SPEECH Language (Default: English)

SPEECH > SPEECH Language

Set the desired speech language to English or Japanese.

SPEECH items (Continued)

Alphabet (Default: Normal)

SPEECH > Alphabet

Select either "Normal" or "Phonetic Code" to announce the alphabet characters.

- Normal : Normal code is used. (for example: A as eh, B as bee)
- Phonetic Code : Phonetic code is used. (for example: A as Alfa, B as Bravo)

SPEECH Speed (Default: Fast)

SPEECH > SPEECH Speed

Set the speech speed to Slow or Fast.

SPEECH Level (Default: 7)

SPEECH > SPEECH Level

Adjust the voice synthesizer volume level to between 0 (OFF), 1 (minimum) and 9 (maximum).

The voice synthesizer audio output level is linked with the [VOL] setting from the minimum audio volume up to the set level.

DTMF items

You can set the DTMF tone code and DTMF memory channel for DTMF tone operation.
See pages 13-5 to 13-7 for details.

DTMF Memory **(Default: d0)**

DTMF > DTMF Memory

Shows a list of the DTMF memory channels.

- d0 to d# : DTMF memory channel list

DTMF Speed **(Default: 100ms)**

DTMF > DTMF Speed

Select the DTMF transmit speed.

- 100ms: Transmits the DTMF codes at about 100 milliseconds per code.
5 characters per second.
- 200ms: Transmits the DTMF codes at about 200 milliseconds per code.
2.5 characters per second.
- 300ms: Transmits the DTMF codes at about 300 milliseconds per code.
1.6 characters per second.
- 500ms: Transmits the DTMF codes at about 500 milliseconds per code.
1 character per second.

QSO/RX Log items

QSO Log (Default: OFF)

QSO/RX Log > QSO Log

Select whether or not to make a communication log on an SD card.

The communication log can be made on an SD card, and saved in the “csv” format.

Be sure to insert the SD card into the card slot before attempting to make the log.

- OFF: The QSO Log function is OFF.
- ON: The transceiver makes a log on the SD card.
The transceiver starts making a log when you begin talking.

NOTE:

- The folder name is automatically created, as [ID-5100\QsoLog].
- The file name is automatically created, as shown in the example below:
Log start date and time: 2014/4/1 15:30:00
File name: 20140401_153000.csv
- The log contents cannot be displayed on the transceiver.
- You can view the log contents on a PC.

RX History Log (Default: OFF)

QSO/RX Log > RX History Log

Select whether or not to make a DV mode’s receive history log on an SD card.

The receive history log can be made on an SD card, and saved in the “csv” format. Be sure to insert the SD card into the transceiver before attempting to make the log.

- OFF: The RX History Log function is OFF.
- ON: The transceiver makes a DV mode’s receive history log on the SD card.
The transceiver starts making a receive history log when you finish talking.

NOTE:

- The folder name is automatically created, as [ID-5100\RxLog].
- The file name is automatically created, as shown in the example below:
Log start date and time: 2014/4/1 15:30:00
File name: 20140401_153000.csv
- The log contents cannot be displayed on the transceiver.
- You can see the log contents on a PC.

Separator/Decimal (Default: Sep [,] Dec [.]*)

QSO/RX Log > CSV Format > Separator/Decimal

Select the separator and the decimal character for the CSV format.

- Sep [,] Dec [.]: Separator is “,” and Decimal is “.”
- Sep [;] Dec [.] : Separator is “;” and Decimal is “.”
- Sep [;] Dec [;]: Separator is “;” and Decimal is “;”

*The default value may differ, depending on the transceiver version.

Date (Default: mm/dd/yyyy*)

QSO/RX Log > CSV Format > Date

Select the date format between “yyyy/mm/dd,” “mm/dd/yyyy” and “dd/mm/yyyy.” (y: year, m: month, d: day)

*The default value may differ, depending on the transceiver version.

QSO/RX Log items (Continued)

The log contents are shown below:

Contents	Example		Descriptions
TX/RX	TX	RX	Transmission and reception
Date	4/1/2014 13:51:48	4/1/2014 13:51:48	Date and time the call was started.
Frequency	438.010000	438.010000	Operating frequencies (When Duplex is set, the RX frequency is displayed.)
Mode	DV	DV	Operating mode (AM/AM-N/FM/FM-N/DV)
My Latitude	34.764667	34.764667	Your latitude (unit: degree) (+: North latitude, -: South latitude)
My Longitude	135.375333	135.375333	Your longitude (unit: degree) (+: East longitude, -: West longitude)
My Altitude	50.5	50.5	Your altitude (unit: m) Records to one decimal place.
RF Power	Low	(Blank)	TX output power level
S-meter	(Blank)	S0	The relative signal strength of the receive signal (in twelve levels)
RPT Call Sign	JP3YHJ A	JP3YHJ A	Repeater call sign (DV mode only)
TX Call Sign	CQCQCQ	(Blank)	TX Call sign (DV mode only)
RX Call Sign	(Blank)	JA3YUA A/ ID-5100	RX Call sign (DV mode only)
RX Latitude	(Blank)	34.764667	Caller's latitude, if sent. (unit: degree) (+: North latitude, -: South latitude) Records only when you receive in the DV mode.
RX Longitude	(Blank)	135.375333	Caller's longitude, if sent. (unit: degree) (+: East longitude, -: West longitude) Records only when you receive in the DV mode.
RX Altitude	(Blank)	30.5	Caller's altitude, if sent. (unit: m) Records only when you receive in the DV mode.

QSO/RX Log items (Continued)

The log contents are shown below:

Contents	Example	Descriptions
Frequency	438.010000	RX Frequency
Mode	DV	Operating mode (DV mode is fixed)
Caller	JA3YUA A	Call sign of the caller station (up to 8 characters)
/	5100	Note after the call sign (up to 4 characters)
Called	CQCQCQ	Call sign of the called station
Rx RPT1	JP3YHH G	Access repeater call sign of the caller station or the gateway repeater call sign of your local area repeater.
Rx RPT2	JP3YHJ A	Access repeater call sign of the called station
Message	Hello CQ D-STAR!	Message included in the received call (up to 20 characters)
Status	(Blank)	Normal: blank, Uplink: "RPT UP", Access repeater reply: "UR?" or "RPT?"
Received date	12/23/2012 13:51:48	Date and time the call was received Depending on the setting, the format may differ.
BK	*	BK call: "**", Normal call: Blank
EMR	*	EMR call: "**", Normal call: Blank
Latitude	34.764667	Caller's latitude, if sent. (unit: degree) (+: North latitude, -: South latitude)
Longitude	135.375333	Caller's longitude, if sent. (unit: degree) (+: East longitude, -: West longitude)
Altitude	30.5	Caller's altitude, if sent. (unit: m) Records to one decimal place.
SSID	-A	Caller's SSID, if sent. (0, -1 to -15, -A to -Z)
D-PRS Symbol	Car	Icon: Converts to text, None: Code
Course	123	Caller's course (unit: degree)
Speed	23.5	Caller's speed (unit: km/h) Records to one decimal place.
Power	49	TX power (unit: W)
Height	24	Antenna height (unit: m)
Gain	6	Antenna gain (unit: dB)
Directivity	Omni	Antenna directivity (Omni, 45, 90, 135, 180, 225, 270, 315 or 360)
Object/Item Name	HAM FES	Object name or Item name (up to 9 characters)
Data Type	Live Object	Data type of Object or Item (Live or Kill)
Temperature	20.5	Temperature (unit: °C) Records to two decimal places.
Rainfall	253.75	Rainfall (unit: mm) Records to two decimal places.
Rainfall (24 Hours)	253.75	Rainfall (24 Hours) (unit: mm) Records to two decimal places.
Rainfall (Midnight)	253.75	Rainfall (Midnight) (unit: mm) Records to two decimal places.
Wind Direction	315	Wind Direction (unit: degree)
Wind Speed	10.0	Wind Speed (unit: m/s) Records to one decimal place.
Gust Speed	10.0	Gust Speed (unit: m/s) Records to one decimal place.
Barometric	1013.0	Barometric (unit: hPa) Records to one decimal place.
Humidity	85	Humidity (unit: %)
GPS Time Stamp	12:00:00	Time data that the caller station acquires the position data
GPS Message	Osaka City/ID-5100	Caller is "NMEA": Records the GPS message Caller is "D-PRS": Records the D-PRS comment

Function items

Squelch/ATT Select (Default: S-Meter Squelch)

Function > Squelch/ATT Select

Select the function that varies according to the [SQL] control position.

- OFF: Both the S-Meter Squelch and Attenuator are disabled.
- S-Meter Squelch: The S-Meter Squelch activates and adjusts the squelch level when [SQL] is set between 12 o'clock and the fully clockwise position.
- ATT: The Attenuator is enabled and adjusts the attenuator level when [SQL] is set between 12 o'clock and the fully clockwise position.

Squelch Delay (Default: Short)

Function > Squelch Delay

Set the squelch delay to short or long to prevent repeated opening and closing of the squelch when receiving the same signal.

- Short: Shortens the time until the squelch opens.
- Long: Lengthens the time until the squelch opens.

Fan Control (Default: Auto)

Function > Fan Control

Select the cooling fan control between Slow, Mid, Fast and Auto.

- Slow: The fan rotates slow.
- Mid: The fan rotates at mid speed.
- Fast: The fan rotates fast.
- Auto: The fan automatically turns ON during transmission or when the internal temperature of the transceiver exceeds the preset value. It remains ON until the temperature drops below the value.

Dial Speed-UP (Default: ON)

Function > Dial Speed-UP

Turn the dial speed acceleration ON or OFF. The acceleration automatically speeds up the tuning dial speed when you rapidly rotate [DIAL].

- OFF: Turns OFF the function.
- ON: Turns ON the function.

Auto Repeater

Function > Auto Repeater

This item appears only in the Korean and U.S.A. version transceivers.

The Auto repeater function automatically turns the duplex operation and tone encoder* ON or OFF. The offset and repeater tone* are not changed by the auto repeater function. Reset these setting values, if necessary.

For U.S.A. version

- OFF: Turns OFF the function.
- ON (DUP): Turns ON the duplex operation only. (Default)
- ON (DUP, TONE): Turns ON the duplex operation and tone encoder*.

For Korean version

- OFF: Turns OFF the function.
- ON: Turns ON the duplex operation and tone encoder*. (Default)

*The tone encoder will not be turned ON in the DV mode.

Remote MIC Key

Function > Remote MIC Key

The function assignments for [F-1] and [F-2] keys on the optional HM-207 REMOTE-CONTROL MICROPHONE can be changed.

See pages 12-53, 12-54 for the assignable key functions.

- During RX/Standby: The assigned key function is enabled while receiving or in standby.
- During TX: The assigned key function is enabled during transmission.

Up/Down MIC Key

Function > Remote MIC Key

The function assignments for the [UP] and [DN] keys on the optional HM-154 HAND MICROPHONE can be changed.

See pages 12-53, 12-54 for the assignable key functions.

- During RX/Standby: The assigned key function is enabled during receiving or standby.
- During TX: The assigned key function is enabled during transmission.

Function items (Continued)

• During RX/Standby:

●: Default setting ○: Available N/A: Not available

Function	Description	Remote MIC Key		Up/Down MIC Key	
		[F-1]	[F-2]	[UP]	[DN]
---	No function	○	○	○	○
UP	Push to increase the frequency, Memory channel, repeater or station call sign.	N/A	N/A	●	○
DOWN	Push to decrease the frequency, Memory channel, repeater or station call sign.	N/A	N/A	○	●
VOL UP	Push to increase the volume level.	N/A	N/A	○	○
VOL DOWN	Push to decrease the volume level.	N/A	N/A	○	○
SQL UP	Push to increase the squelch level.	N/A	N/A	○	○
SQL DOWN	Push to decrease the squelch level.	N/A	N/A	○	○
Monitor	Push to open or close the squelch.	○	●	○	○
CALL	Push to select a call channel.	N/A	N/A	○	○
MR (000 CH)	In the Memory mode, push to select Memory channel 000.	○	○	○	○
MR (001 CH)	In the Memory mode, push to select Memory channel 001.	○	○	○	○
VFO/MR	Push to toggle between the VFO mode and the Memory mode.	N/A	N/A	○	○
DR	Push to turn the DR function ON or OFF.	○	○	○	○
FROM/TO (DR)	In the DR screen, push to toggle between "FROM" and "TO."	○	○	○	○
Home CH	Push to directly select the Home CH that is set to the selected mode (VFO/Memory) or DR screen. While in the CALL CH or weather channel mode, or when no Home CH is set, an error beep sounds.	N/A	N/A	○	○
BAND/BANK	Push to select an operating band. In the VFO mode, push to change the operating band, and in the Memory Bank mode, push to select Bank A to Z, or OFF. • Only the programmed bank appears.	●	○	○	○
SCAN	Push to start a scan. While scanning, push to stop the scan.	○	○	○	○
Temporary Skip	Push to set the frequency to be skipped during scanning. The selected frequencies are temporarily skipped for faster scanning.	○	○	○	○
RX>CS	Hold down for 1 second to set the last calling station call sign to "TO" (destination).	○	○	○	○
SPEECH	Push to announce the frequency, operating mode or call sign. - In the VFO, Memory and Call channel mode, the frequency and the operating mode are announced. - In the DR screen, the call sign is announced. If Simplex is selected, the frequency is announced.	○	○	○	○
MAIN/DUAL	While in the single display mode, push the key to toggle between the A Band and B Band. While in the dual display mode, push the key to toggle between the MAIN Band and SUB Band. Hold down the key to toggle between the single display and the dual display.	N/A	N/A	○	○
MODE	Push to change the operating mode.	○	○	○	○
LOW	Push to change the transmit power level.	○	○	○	○
DUP	Push to turn the Duplex mode ON or OFF, and the shift direction to DUP+ or DUP-.	○	○	○	○
PRIO	Push to turn the Priority watch ON or OFF.	○	○	○	○

Continued on the next page

Function items (Continued)

• During RX/Standby (Continued):

●: Default setting ○: Available N/A: Not available

Function	Description	Remote MIC Key		Up/Down MIC Key	
		[F-1]	[F-2]	[UP]	[DN]
TONE/DSQL	Push to toggle between tone types. <<MODE>> FM/FM-N "TONE" (Repeater Tone) "TSQL ((·))" (Pocket Beep with Tone Squelch) "TSQL" (Tone Squelch) "DTCS ((·))" (Pocket Beep with DTCS Code Squelch) "DTCS" (DTCS Code Squelch) "TSQL-R" (Reverse Tone Squelch) "DTCS-R" (Reverse DTCS Code Squelch) <<MODE>> DV * This can be also set in the DR screen. "DSQL ((·))" (Pocket Beep with Digital Call sign Squelch) "DSQL" (Digital Call sign Squelch) "CSQL ((·))" (Pocket Beep with Digital Code Squelch) "CSQL" (Digital Code Squelch)	○	○	○	○
MW	In the VFO mode or in the DR screen, hold down to save the frequency displayed in the MAIN band into a Memory channel. • The frequency is automatically saved in a blank channel.	○	○	○	○
MUTE	Push to turn the Mute function ON or OFF.	○	○	○	○
Voice TX (T1)	Push to transmit the voice audio recorded on the SD card once. Hold down for 1 second to repeatedly transmit the voice audio. • This key function can also be used in the DR screen. If the voice audio is not stored in the [T1] (Voice memory number for TX) in the Voice TX record screen, this function is invalid.	○	○	○	○
DTMF DIRECT TX	Push to display the DTMF code direct entry mode screen.	○	○	N/A	N/A
T-CALL	Push to transmit a 1750 Hz tone.	○	○	○	○

• During TX:

●: Default setting ○: Available N/A: Not available

Function	Description				
---	No function	○	●	●	●
LOW	Push to change the transmit power level.	○	○	○	○
Voice TX	Push to transmit the voice audio recorded on the SD card once. Hold down for 1 second to repeatedly transmit the voice audio. - To make a repeat transmission, [PTT] must be released.	○	○	○	○
T-CALL	Push to transmit a 1750 Hz tone.	●	○	○	○

Function items (Continued)

One-Touch PTT (Remote MIC) (Default: OFF)

Function > One-Touch PTT (Remote MIC)

Set the On-Touch PTT function for the HM-207 REMOTE-CONTROL MICROPHONE.

The function enables you to transmit without sequentially holding down the [PTT] button.

- OFF: Push [PTT] to transmit and release to receive.
- ON: Push [PTT] to transmit, then push again to receive.

PTT Lock (Default: OFF)

Function > PTT Lock

Turn the PTT lock function ON or OFF.

To prevent accidental transmissions, this function disables [PTT].

- OFF: Turns OFF the function.
- ON: Turns ON the function.

Busy Lockout (Default: OFF)

Function > Busy Lockout

Turn the busy lockout function ON or OFF.

This function inhibits transmission while receiving a signal, or when the squelch is open.

- OFF: Turns OFF the function.
- ON: Turns ON the function.

Time-Out Timer (Default: OFF)

Function > Time-Out Timer

To prevent accidental prolonged transmission, the transceiver has a time-out timer.

The function inhibits continuous transmissions longer than the set time period.

- OFF: Turns OFF the function.
- 1 to 30 min: The transmission is cut OFF after the set time period ends (1, 3, 5, 10, 15 or 30 minutes).

Active band (Default: All)

Function > Active Band

Allows continuous frequency selection of the operating frequency across all bands using [DIAL].

- Single: When you rotate [DIAL] on the band edge, the top or bottom frequency in the displayed band is selected.
- ALL: When you rotate [DIAL], the next band is displayed.

NOTE:

When "Single" is selected, touch [QUICK] to display the Quick Menu, and then touch "Band Select" to select another band.

This setting is for the [DIAL] operation, so all frequencies will be scanned, even if "Single" is selected.

MIC Gain (Default: 2*)

Function > MIC Gain

Set the microphone gain to between 1 (minimum) and 4 (maximum), to suit your preference.

Higher values make the microphone more sensitive to your voice.

*The default settings may differ, depending on your transceiver version.

Touch Operation (Sub) (Default: Main Select)

Function > Touch Operation (Sub)

Select the transceiver's operation by touching on the SUB band screen.

- Main Select: Changes to the MAIN band.
- Function Select: Touch operation is activated on the SUB band.

Keyboard Type (Default: Full Keyboard)

Function > Keyboard Type

Select the keyboard entry type between Ten-Key and Full Keyboard to enter a call sign, memory name, and so on.

When the edit screen is displayed, you can select the keyboard type in the Quick Menu.

NOTE:

Even if Full Keyboard is selected, the Ten-Key will open to enter a frequency.

Function items (Continued)

Data Speed (Default: 9600bps)

Function > Data Speed

Select the data transmission speed for outputting a GPS information, inputting a weather information or low-speed data communication in the DV mode to 4800 bps or 9600 bps.

CI-V Address (Default: 8Ch)

Function > CI-V > CI-V Address

To distinguish equipment, each CI-V transceiver has its own Icom standard address in hexadecimal code.

The ID-5100A/E's default address is 8Ch.

When 2 or more ID-5100A/Es are simultaneously controlled by a PC, set a different address for each transceiver between 01h and DFh (hexadecimal).

CI-V Baud Rate (Default: Auto)

Function > CI-V > CI-V Baud Rate

Set the CI-V data transfer speed to 4800, 9600, 19200 bps or Auto.

When "Auto" is selected, the baud rate is automatically set according to the data rate of the controller.

CI-V Transceive (Default: OFF)

Function > CI-V > CI-V Transceive

Turn the CI-V Transceive function ON or OFF.

- OFF: Turns OFF the function.
- ON: When you change a setting on one transceiver, the same settings is automatically changed on other connected transceivers or receivers.

CI-V Bluetooth→REMOTE Transceive Address (Default: 00h)

Function > CI-V > CI-V Bluetooth→REMOTE Transceive Address

If you remotely operate your transceiver using Bluetooth® when "CI-V Transceive" is set to ON, the devices in the same system are also externally controlled through the [SP2](REMOTE) jack.

To prohibit the external control of an Icom transceiver, set this value to other than "00h."

The control signal is output from the [SP2](REMOTE) terminal.

Select an address between 00h and DFh.

Heterodyne (A BAND VHF) (Default: Normal)

Function > Heterodyne (A BAND VHF)

Effective to eliminate internal spurious that may occur in a rare combination of dual band frequencies, when operating VHF on the A band.

A spurious signal may cause the S-meter to fluctuate, even when no signal is received, for example.

The Heterodyne function shifts the 1st Local Oscillator frequency to the opposite side of the signal to change the frequency combination.

- Normal: Does not reverse the heterodyne when operating VHF on the A band.
- Reverse: Reverses the heterodyne when operating VHF on the A band.

Heterodyne (A BAND UHF) (Default: Normal)

Function > Heterodyne (A BAND UHF)

Effective to eliminate internal spurious that may occur in a rare combination of dual band frequencies, when operating UHF on the A band.

- Normal: Does not reverse the heterodyne when operating UHF on the A band.
- Reverse: Reverses the heterodyne when operating UHF on the A band.

Heterodyne (B BAND UHF) (Default: Normal)

Function > Heterodyne (B BAND UHF)

Effective to eliminate internal spurious that may occur in a rare combination of dual band frequencies, when operating UHF on the B band.

- Normal: Does not reverse the heterodyne when operating UHF on the B band.
- Reverse: Reverses the heterodyne when operating UHF on the B band.

Power OFF (With No Controller) (Default: ON)

Function > Power OFF (With No Controller)

Select whether or not to automatically turn OFF the transceiver when the controller is disconnected from the transceiver.

- OFF: The transceiver power is not turned OFF.
 - To turn OFF the transceiver power, turn OFF the DC supply, or disconnect the power cable.
 - When you connect the controller again, the controller may perform incorrectly. This is not the controller's malfunction
- ON: The transceiver is automatically turned OFF.

Display items

Backlight (Default: 8)

Display > Backlight

Set the backlight brightness level to between 1 (Dark) and 8 (Bright).

Auto Dimmer (Default: OFF)

Display > Auto Dimmer

This function sets the Auto Dimmer operation.

- OFF: Auto Dimmer function is turned OFF. The backlight is turned ON continuously while the transceiver is turned ON.
- Auto-OFF: The backlight is automatically turned ON when touching the touch panel or rotating [DIAL]. The backlight is automatically turned OFF after the set time of inactivity in the Auto Dimmer Timer.
- Auto-1 to Auto-7: The backlight is automatically turned ON when touching the touch panel or rotating [DIAL]. The backlight automatically returns to the 1 to 7 set level after the Auto Dimmer Timer set time ends.

Auto Dimmer Timer (Default: 5sec)

Display > Auto Dimmer Timer

Set the backlight lighting time period to between 5 and 10 seconds.

- 5sec: The Auto dimmer function automatically activates after 5 seconds of inactivity.
- 10sec: The Auto dimmer function automatically activates after 10 seconds of inactivity.

Touch Operation (Dimmed) (Default: Brighten & Action)

Display > Touch Operation (Dimmed)

Select the transceiver's action when you touch the screen while the Auto dimmer is activated.

- Brighten: Cancels the Auto dimmer, and the backlight turns ON.
- Brighten & Action: Cancels the Auto dimmer, and the backlight turns ON, then activates the touch operation.

LCD Contrast (Default: 8)

Display > LCD Contrast

Set the contrast of the LCD.

Set the level to between 1, the lowest contrast, and 16, the highest.

RX Call Sign (Default: Normal)

Display > RX Call Sign

When a call is received, select whether or not to display the call sign and the message of the caller station.

- OFF: The caller station's call sign and message are not displayed.
- Normal: The caller station's call sign and message scroll only once across the display.
- RX Hold: The caller station's call sign and message scroll once, and then only the call sign is displayed until the signal disappears.
- Hold: The caller station's call sign and message scroll only once, and then only the call sign is displayed until the signal disappears. When the signal disappears, the call sign and the message are alternately displayed, each for 2 seconds.

NOTE: When this item is set to "Normal," "RX Hold" or "Hold," and if you program the caller station's call sign and name in Your Call Sign screen, the screen displays the programmed name after the call sign.

RX Position Indicator (Default: ON)

Display > RX Position Indicator

Select whether or not to display "↖" (RX position indicator) when the signal received in the DV mode contains position data.

- OFF : Displays no indicator even though the received signal contains position data.
- ON : Displays the indicator when the received signal contains position data.

NOTE: When the "RX Call Sign Display" is set to "OFF," the indicator is not displayed even though the received signal contains position data.

Display items (Continued)

RX Position Display (Default: ON (Main/Sub))

Display > RX Position Display

Select whether or not to display the caller's position in a dialog when the signal received in the DV mode contains a caller station's position.

- OFF: Does not display the caller's position.
- ON (Main/Sub): Displays the caller's position.
- ON (Main Only): Displays the caller's position, received in only the MAIN band.

/// You can set the display time period in the "RX Position Display Timer" item.

RX Position Display Timer (Default: 10sec)

Display > RX Position Display Timer

Set the display time period for the caller's position.

- 5/10/15/30sec: Displays the caller's position for this set period.
- Hold: Displays the caller's position until you operate the transceiver.

Reply Position Display (Default: ON)

Display > Reply Position Display

Select whether or not to display the caller's position in a dialog when the Auto Reply signal contains a caller station's position.

- OFF: Does not display the caller's position.
- ON: Displays the caller's position.

TX Call Sign (Default: Your Call Sign)

Display > TX Call Sign

Select whether or not to display your own or the destination call sign while transmitting in the DV mode.

- OFF: Does not display any call sign.
- Your Call Sign: Displays and scrolls the destination's call sign.
When the destination's call sign and name are entered in your memory, the transceiver displays the name after the call sign in any DV mode except when using the DR function.
- My Call Sign: Displays and scrolls your own call sign.

Scroll Speed (Default: Fast)

Display > Scroll Speed

This item sets the scrolling speed of the message, call sign, or other text, that is displayed on the screen.

- Slow: The scroll speed is slow.
- Fast: The scroll speed is fast.

Opening Message (Default: ON)

Display > Opening Message

Select whether or not to display the opening message at power ON.

- OFF: Opening message is not displayed.
- ON: Icom logo, MY call sign, the product model ("ID-5100A" or "ID-5100E")* are displayed.
*Depending on the version.

Voltage (Power ON) (Default: ON)

Display > Voltage (Power ON)

Select whether or not to display the voltage of the external DC power source at power ON.

- OFF: Does not display the voltage of the external DC power source at power ON.
- ON: Displays the voltage of the external DC power source at power ON.

/// **NOTE:** When the voltage of the external DC power source is over 17.0 V, "Over Voltage" is displayed and disconnect the DC power source immediately.

Latitude/Longitude (Default: ddd °mm.mm')

Display > Display Unit > Latitude/Longitude

Select either the ddd °mm.mm' or ddd °mm:ss" format to display the position.

Altitude/Distance (Default: feet/mile*)

Display > Display Unit > Altitude/Distance

Select either the meter or feet/mile format to display the distance and altitude.

*The default setting may differ, depending on the transceiver's version.

Display items (Continued)

Speed (Default: mph*)

Display > Display Unit > Speed

Select either the km/h, mph or knots format to display the speed.

Temperature (Default: °F*)

Display > Display Unit > Temperature

Select either the degrees °C or °F format to display the temperature.

Barometric (Default: inHg*)

Display > Display Unit > Barometric

Select between the hPa, mb, mmHg and inHg format to display the barometric pressure.

Rainfall (Default: inch*)

Display > Display Unit > Rainfall

Select either the mm or inch format to display the amount of rainfall.

Wind Speed (Default: mph*)

Display > Display Unit > Wind Speed

Select between the m/s, mph and knots format to display the wind speed.

Display Language (Default: English)

Display > Display Language

/// This item appears only when the "System Language" is set to "Japanese."
 /// See page 12-60 "Choose your language carefully" about setting cautions.

Set the screen display language type in the DR screen or Menu screen to English or Japanese.

System Language (Default: English)

Display > System Language

Set the system language of the transceiver to English or Japanese.

- English: The system language of the transceiver is English.
 - Only alphabetical characters (A to Z, a to z, 0 to 9) and symbols (! " # \$ % & ' () * + , - . / : ; < = > ? @ [\] ^ _ ` { | } ~) can be displayed. If Japanese characters (Kanji, Hiragana and Katakana) are included, the LCD shows "＝" or "＿" instead of that character. In this case, you can only delete "＝" or "＿" in the transceiver's edit mode.
 - The Display Language item will be hidden.
- Japanese: The system language of the transceiver is Japanese. Kanji, Hiragana and Katakana characters, and the 2-bytes symbols can be displayed on the LCD. To display such characters in the DR screen or Menu mode, Display Language must be set to "Japanese."

*The default value may differ, depending on the transceiver's version.

Display items (Continued)

Choose your language carefully

When the system language of the transceiver is set to Japanese, the transceiver has the capability to display both English and Japanese characters. HOWEVER, if you select Japanese as the display language, all menu items throughout the transceiver system will be displayed in only Japanese characters. There will be no English item names. Unless you are fluent in reading Japanese characters, use this feature with extreme caution.

If you change the transceiver’s language to Japanese, and can’t understand the menu system in the new setting, you will have to change the language back to English in “Display Language” or “System Language” (this item), or by doing a partial reset of the transceiver CPU. A partial reset will not clear your call sign databases.

To do a partial reset of the CPU, do the following steps:

1. Touch [MENU].
2. Touch [▼] one or more times to select the third page, and touch the item.

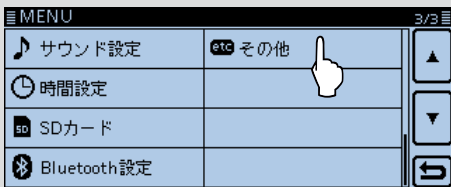

3. Touch [▼] one or more times to view the item as show below, and touch it.

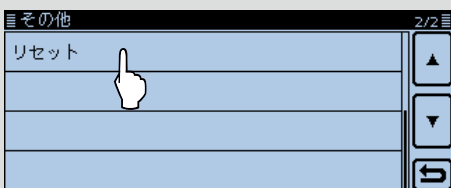

4. Touch the upper item.

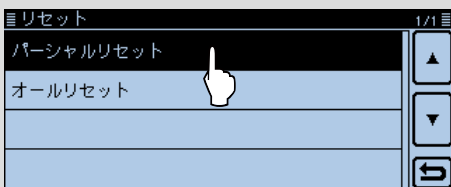

5. The dialog appears. Touch the left option.
 - The transceiver displays “PARTIAL RESET,” then the partial reset is completed.

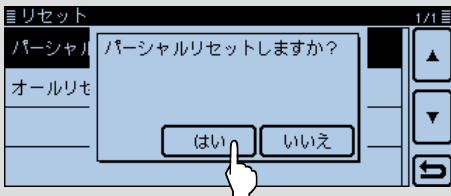

Sounds items

Beep Level (Default: 9)

Sounds > Beep Level

Set the beep audio output level to between 0 (OFF), 1 (minimum) and 9 (maximum).

Key-Touch Beep (Default: ON)

Sounds > Key-Touch Beep

Turn the confirmation beep tones ON or OFF.

- OFF: No beep sounds.
- ON: A beep sounds when you touch a screen.

Home CH Beep (Default: ON)

Sounds > Home CH beep

Turn the Home CH Beep ON or OFF.

- OFF: No beep sounds.
- ON: Sounds a beep when you select the Home CH by rotating [DIAL].

 **NOTE:** You can set a Home CH for the VFO mode, Memory mode and the DR function. (p. 2-16)

Band Edge Beep (Default: OFF)

Sounds > Band Edge Beep

Turn the Band edge beep ON or OFF.

- OFF: No beep sounds.
- ON: A beep sounds when you tune into or out of the AIR, VHF and UHF band's frequency range by rotating [DIAL].

Scan Stop Beep (Default: OFF)

Sounds > Scan Stop Beep

Turn the scan stop beep ON or OFF.

- OFF: No beep sounds.
- ON: A beep sounds when a scan stops by receiving a signal.



Standby Beep (Default: ON (to me: High Tone))

Sounds > Standby Beep

Turn the standby beep function ON or OFF.

This function sounds a beep after a received signal disappears, in the DV mode.

- OFF: Turns OFF the function.
- ON: Sounds a beep after a received signal disappears.
- ON (to me: High Tone): Sounds a beep after a received signal disappears. If the signal is addressed to your call sign, a higher tone beep sounds.

-  • The standby beep sounds even when the "Key-touch beep" is set to "OFF."
-  • You can set the standby beep output level with the "Beep level" item.

Sub Band Mute (Default: OFF)

Sounds > Sub Band Mute

Select whether or not to mute the SUB band audio signal while receiving on the MAIN band, and/or sound a beep when a signal disappears on the SUB band.

- OFF: Disables the SUB band mute function.
- Mute: While receiving on the MAIN band, the SUB band audio signal is muted.
- Beep: When a signal disappears on the SUB band, a beep sounds. The beep sounds even if no signal is received on the MAIN band.
- Mute & Beep: While receiving on the MAIN band, the SUB band audio signal is muted. While receiving on the SUB band, and a signal disappears, a beep sounds.
 - The beep sounds even if no signal is received on the MAIN band.

Scope AF Output (Default: ON)

Sounds > Scope AF Output

Select the audio output option during a sweep by the Band Scope function.

- OFF: No audio is heard during the sweep.
- ON: Audio is heard during the sweep.
 - Only when the dual watch mode is selected.

Time Set items

DATE

Time Set > Date/Time > DATE

Manually set the date to between 2000/01/01 and 2099/12/31.

TIME

Time Set > Date/Time > TIME

Manually set the time that is displayed at the top of the screen to between 0:00 and 23:59. The time is displayed in the 24 hour format.

▨ The time is automatically set by calculating the received UTC (Universal Time of Coordinated) time and the "UTC Offset" setting, if the "GPS Time Correct" item is set to "Auto."

GPS Time Correct (Default: Auto)

Time Set > GPS Time Correct

This function can correct the time by using the time information that a GPS sentence contains.

It is corrected by calculating the received UTC (Universal Time of Coordinated) time and the set "UTC Offset"

- OFF: The function is OFF.
- Auto: The function is ON.

UTC Offset (Default: ±0:00)

Time Set > UTC Offset

Set the time difference between UTC (Universal Time Coordinated) and the local time to between -14:00 and +14:00 in 00:05 steps.

Auto Power OFF (Default: OFF)

Time Set > Auto Power OFF

This function automatically turns OFF the power after this set time period of inactivity.

- OFF: Does not turn OFF the power.
- 30/60/90/120min: Turns OFF the power after inactivity for this set period.

▨ "AUTO POWER OFF" is displayed and beeps sound 5 seconds before turning OFF the power. If you operate the transceiver during this period, the Auto Power OFF timer will be reset.

SD Card items

Load Setting

SD Card > Load Setting

Select from the list when you load the setting file.

Save Setting

SD Card > Save Setting

Save the setting file.

Import

SD Card > Import/Export > Import

Import the UR call sign, repeater list or GPS memory data in the CSV format file.

Export

SD Card > Import/Export > Export

Export the UR call sign, repeater list or GPS memory data in the CSV format file.

Separator/Decimal (Default: Sep [,] Dec [.]*)

SD Card > Import/Export > CSV Format > Separator/Decimal

Select the separator and the decimal character for the CSV format.

- Sep [,] Dec [.]: Separator is “,” and Decimal is “.”
- Sep [;] Dec [.]: Separator is “;” and Decimal is “.”
- Sep [;] Dec [,]: Separator is “;” and Decimal is “,”

*The default value may differ, depending on the transceiver version.

Date (Default: mm/dd/yyyy*)

SD Card > Import/Export > CSV Format > Date

Select the date format between “yyyy/mm/dd,” “mm/dd/yyyy” and “dd/mm/yyyy” (y: year, m: month, d: day)

*The default value may differ, depending on the transceiver version.

SD Card Info

SD Card > SD Card Info

Displays the SD card’s free space and its remaining recording time.

Format

SD Card > Format

Formats the SD card, deleting all data.

Unmount

SD Card > Unmount

Electrically unmounts the SD card while the power is ON.

Bluetooth Set items

The optional UT-133 Bluetooth® UNIT is required.

Bluetooth (Default: OFF)

Bluetooth Set > Bluetooth

Turns the Bluetooth® function ON or OFF.

To use the Bluetooth® function the optional UT-133 Bluetooth® UNIT is required.

- OFF: Turns OFF the function.
- ON: Turns ON the function.

Auto Connect (Default: ON)

Bluetooth Set > Auto Connect

Select whether or not to automatically connect to the paired Bluetooth® device when its power is turned ON.

- OFF: Does not connect to the paired device.
- ON: Automatically connects to the last connected device.

Paring/Connect

Bluetooth Set > Paring/Connect

Select to search for the Bluetooth® device to connect, or view the paired Bluetooth® devices in the list.

See page 15-6 for details.

<<Paring Reception>>

Bluetooth Set > <<Paring Reception>>

Select to indicate to Bluetooth® devices you can accept paring requests.

See page 15-12 for details.

AF Output (Default: Headset Only)

Bluetooth Set > Headset Set > AF Output

Select the AF Output device when a Bluetooth® headset is connected.

- Headset Only: Outputs audio to only the connected Bluetooth® headset.
- Headset & Speaker: Outputs audio to both the connected Bluetooth® headset and the transceiver's speaker.

VOX (Default: OFF)

Bluetooth Set > Headset Set > VOX > VOX

The VOX (Voice Operated Transmission) function starts transmitting without pushing [PTT] when you speak into the microphone, then automatically returns to receive when you stop speaking.

- OFF: Turns OFF the function.
- ON: Turns ON the function.

NOTE: To use the function, the optional VS-3 Bluetooth® HEADSET is required.

VOX Level (Default: 5)

Bluetooth Set > Headset Set > VOX > VOX Level

Set the VOX gain level between OFF, 1 (minimum sensitivity) and 10 (maximum sensitivity).

Higher values make the VOX function more sensitive to your voice.

To turn OFF the VOX function, set to the "0" position.

NOTE: Before setting the VOX gain level, it is recommended that you set the microphone gain level in "Function" of the Menu screen or the Bluetooth® headset.

VOX Delay (Default: 0.5sec)

Bluetooth Set > Headset Set > VOX > VOX Delay

Set the VOX Delay time to 0.5, 1.0, 1.5, 2.0, 2.5 or 3.0 seconds.

The VOX Delay is the amount of time the transmitter stays ON after you stop speaking, before the VOX switches to receive.

VOX Time-Out Timer (Default: 3min)

Bluetooth Set > Headset Set > VOX > VOX Time-Out Timer

Set the VOX Time-Out Timer to 1, 2, 3, 4, 5, 10 or 15 minutes to prevent an accidental prolonged transmission.

If a continuous transmission exceeds the set period, the transmission will be cut off.

To disable the function, set it to "OFF."

Bluetooth Set items (Continued)

Power Save (Default: OFF)

Bluetooth Set > Headset Set > Icom Headset > Power Save

Select whether or not to operate with the power save mode while the optional VS-3 Bluetooth® HEADSET is connected.

When a third-party headset or a data device is connected, the power save mode is automatically turned OFF, regardless of this setting.

- OFF: Turns OFF the function.
- ON: The Power Save mode is enabled when no communication or operation is performed for 120 seconds.

One-Touch PTT (Default: OFF)

Bluetooth Set > Headset Set > Icom Headset > One-Touch PTT

Set the One-Touch PTT function while the optional VS-3 Bluetooth® HEADSET is connected. The function enables you to transmit without continuously holding down [PTT].

When a third-party headset is connected, this function is automatically turned ON, regardless of this setting.

- OFF: Transmits while holding down [PTT].
- ON: Pushing [PTT] toggles transmission and reception.

PTT Beep (Default: OFF)

Bluetooth Set > Headset Set > Icom Headset > PTT Beep

Set the beep sound when you push [PTT] on the optional VS-3 Bluetooth® HEADSET.

- OFF: No beep sounds.
- ON: A beep sounds.

Custom Key Beep (Default: OFF)

Bluetooth Set > Headset Set > Icom Headset > Custom Key Beep

Set the beep sound when you push the Custom Key ([PLAY]/[FWD]/[RWD]) on the optional VS-3 Bluetooth® HEADSET.

- OFF: No beep sounds.
- ON: A beep sounds.

Custom Key

(Default: [PLAY]: ---, [FWD]: UP, [RWD]: DOWN)

Bluetooth Set > Headset Set > Icom Headset > Custom Key

Assigns the following key functions to the Custom Key ([PLAY]/[FWD]/[RWD]) on the optional VS-3 Bluetooth® HEADSET.

Function	Description
---	No function
UP	Push to increase the frequency, Memory channel, repeater or select the next station call sign.
DOWN	Push to decrease the frequency, Memory channel, repeater or select the previous station call sign.
VOL UP	Push to turn up the volume level.
VOL DOWN	Push to turn down the volume level.
SQL UP	Push to turn up the squelch level.
SQL DOWN	Push to turn down the squelch level.
Monitor	Push to open or close the squelch.
CALL	Push to select a call channel.
MR (000 CH)	In the Memory mode, push to select Memory channel 000.
MR (001 CH)	In the Memory mode, push to select Memory channel 001.
VFO/MR	Push to toggle between the VFO mode and the Memory mode.
DR	Push to turn the DR function ON or OFF.
FROM/TO (DR)	In the DR screen, push to toggle between "FROM" and "TO."
HOME CH	Push to directly select the Home CH that is set to the selected mode (VFO/Memory) or DR screen. While in the CALL CH or weather channel mode, or when no Home CH is set, an error beep sounds.
BAND/BANK	Push to select an operating band. In the VFO mode, push to change the operating band, and in the Memory Bank mode, push to select a bank (OFF or A to Z). • Only the programmed bank appears.
SCAN	Push to start the scan. While scanning, push to stop the scan.
Temporary Skip	Push to set the frequency to be skipped during scanning. The selected frequencies are temporarily skipped for faster scanning.
RX>CS	Hold down for 1 second to set the last calling station call sign to "TO" (destination).

Bluetooth Set items (Continued)

Function	Description
SPEECH	Push to announce the frequency, operating mode or call sign. - In the VFO, Memory and Call channel mode, the frequency and the operating mode are announced. - In the DR screen, the call sign is announced. If Simplex is selected, the frequency is announced.
MAIN/DUAL	While in the single display mode, push the key to toggle between the A Band and B Band. While in the dual display mode, push the key to toggle between the SUB Band and MAIN Band. Hold down the key to toggle between the single display and the dual display.
MODE	Push to change the operating mode.
LOW	Push to change the transmit power level.
DUP	Push to toggle the Duplex mode ON or OFF, and the shift direction (DUP+/DUP-).
PRIO	Push to turn the Priority watch ON or OFF.
TONE/DSQL	Push to toggle between tone types. <<MODE>> FM/FM-N "TONE" (Repeater Tone) "TSQL (⋅)" (Pocket Beep with Tone Squelch) "TSQL" (Tone Squelch) "DTCS (⋅)" (Pocket Beep with DTCS Code Squelch) "DTCS" (DTCS Code Squelch) "TSQL-R" (Reverse Tone Squelch) "DTCS-R" (Reverse DTCS Code Squelch) <<MODE>> DV • This key function can also be used in the DR screen. "DSQL (⋅)" (Pocket Beep with Digital Call sign Squelch) "DSQL" (Digital Call sign Squelch) "CSQL (⋅)" (Pocket Beep with Digital Code Squelch) "CSQL" (Digital Code Squelch)
MW	In the VFO mode or in the DR screen, hold down to save the frequency displayed in the MAIN band into a Memory channel. • The frequency is automatically saved in a blank channel.
MUTE	Push to turn the Mute function ON or OFF.
Voice TX (T1)	Push to transmit the voice audio recorded on the SD once. Hold down for 1 second to repeatedly transmit the voice audio. • This key function can also be used in the DR screen. If the voice audio is not stored in the [T1] (Voice memory number for TX) in the Voice TX record screen, this function is disabled.
T-CALL	Push to transmit a 1750 Hz tone.

Serialport Function

(Default: CI-V (Echo Back OFF))

Bluetooth Set > Data Device Set > Serialport Function

Set the serial port function for the Bluetooth® SPP (Serial Port Profile) connection to a data device, PC and so on.

- CI-V (Echo Back OFF):
Transmits or receives a CI-V command.
Does not send back the serial data received from the SPP connection.
- CI-V Echo Back ON:
Transmits or receives a CI-V command.
Sends back the serial data received from the SPP connection.
- DV Data:
Transmits or receives a DV low-speed data.
Does not input the cloning or weather data entries, or output the GPS data.

Bluetooth Device Information

Bluetooth Set > Bluetooth Device Information

Displays the Bluetooth® device information.

Initialize Bluetooth Device

Bluetooth Set > Initialize Bluetooth Device

Initializes the installed Bluetooth® unit.

Others items

Voltage

Others > Information > Voltage

Displays the voltage of the external power supply.

Version

Others > Information > Version

Displays the transceiver firmware's version number. When the optional UT-133 Bluetooth® UNIT is installed, the unit's version number is also displayed.

Clone Mode

Others > Clone > Clone Mode

Select to enter the clone mode to read or write the CS-5100 data from or to the PC. See page 13-12 for details.

<<Repeater Mode>>

Others > Repeater Mode > <<Repeater Mode>>

This item appears only in the U.S.A. version transceiver.

Select to enter the repeater mode.

In the repeater mode, the transceiver receives the signals and automatically retransmits them on a different band frequency. (Cross-Band repeater operation)

See page 13-11 for details.

NOTE: Operate this function carefully according to the local laws and ordinances.

Hang Up Time

Others > Repeater Mode > Hang Up Time

This item appears in only the U.S.A. version transceivers.

Select whether or not to set the hang up time in the duplex repeater mode.

- OFF: Cancels the transmission when the receive signal disappears.
- ON: Cancels the transmission approximately 0.25 seconds after the receive signal disappears.

Touch Screen Calibration

Others > Touch Screen Calibration

Touch to calibrate the touch screen. See page 13-23 for details.

Partial Reset

Others > Reset > Partial Reset

Select to reset the operating settings to their default values (VFO frequency, VFO settings, menu contents) without clearing the items below.

- Memory channel content
 - Scan Edge content
 - Call channel content
 - Call sign memories
 - Message content
 - DTMF memory content
 - GPS Memory content
 - Repeater list content
- See page 17-2 for details.

All Reset

Others > Reset > All Reset

Select to clear all content and return all settings to their factory defaults.

See page 17-3 for details.

Section 13 OTHER FUNCTIONS

Voice TX function	13-2
◇ Recording the voice audio	13-2
◇ Transmitting the recorded voice audio.....	13-3
◇ Changing the voice TX settings.....	13-3
Speech function	13-4
◇ Using the Speech function	13-4
Using the DTMF memory	13-5
◇ Entering DTMF code	13-5
◇ Transmitting DTMF code	13-6
◇ Transmitting DTMF code (Direct Input)	13-6
◇ Setting the DTMF transmit speed.....	13-7
Tone squelch operation	13-8
◇ Tone squelch frequency setting and operation.....	13-8
DTCS squelch operation	13-9
◇ DTCS code setting and operation	13-9
Weather channel operation (USA version only)	13-10
◇ Weather channel selection	13-10
◇ Weather alert function	13-10
Repeater mode operation (USA version only)	13-11
◇ Entering the Repeater mode	13-11
◇ Exiting the Repeater mode.....	13-11
◇ Cross-Band repeater operation	13-11
Cloning function	13-12
◇ Transceiver-to-Transceiver cloning using an SD card	13-12
◇ Cloning from a PC using an SD card	13-15
◇ Cloning from a PC using an optional cloning cable.....	13-15
Remote jack (CI-V) information	13-16
◇ CI-V connection example	13-16
◇ Data format.....	13-16
◇ Command table	13-17
Touch screen calibration function	13-23

Voice TX function

The Voice TX function transmits the audio that is on the SD card, one time or repeatedly, for up to 10 minutes at the specified interval.

Up to 4 memories can be used for repeatedly calling CQ or for other events.

When the key function [Voice TX (T1)] is assigned to a microphone key, push the key to transmit the stored audio in the [T1] (Voice memory number for TX). (p. 12-54)

NOTE: Be sure to first insert an SD card into the transceiver.

◇ Recording the voice audio

① Touch [MENU].

② Touch “Record.”

(Others > Voice TX > Record)

- If the item is not displayed, touch [▲] or [▼] one or more times to select another page.
- Displays the “VOICE TX RECORD” screen.

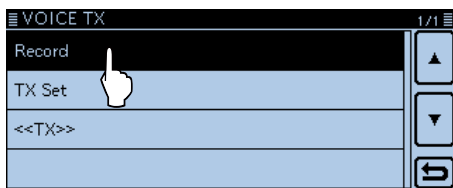

③ Touch the desired memory, [T1] through [T4].

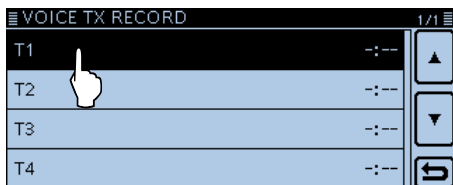

- The “VOICE TX RECORD (T1)” screen is displayed when [T1] memory is selected.

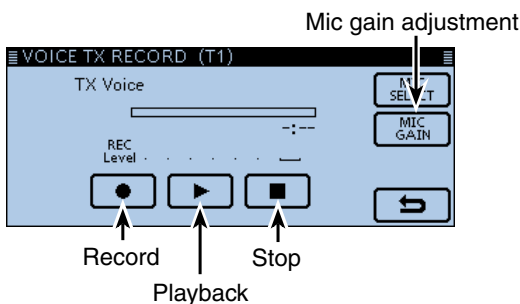

④ Touch [●] to start recording.

- The maximum record time is 1 minute.
- Hold the microphone 5 to 10 cm (2 to 4 inches) from your mouth, then speak at a normal voice level.

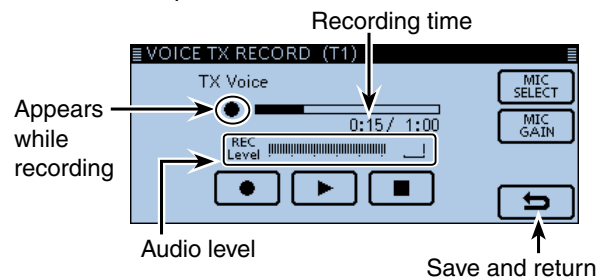

⑤ Touch [■] to stop recording.

⑥ Touch [▶] to playback the recorded audio.

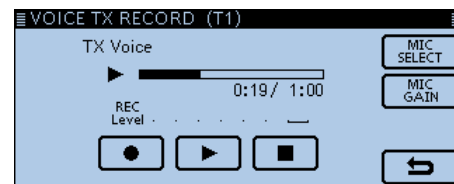

- If you touch [●], the recording starts again. In this case, the previous recorded audio will be overwritten.

⑦ Touch [↶].

- Returns to the “VOICE TX RECORD” screen.

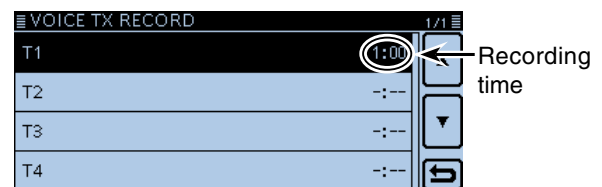

For your reference:

Touch [MIC GAIN] to open the “MIC GAIN” setting window. Touch [+] or [-] to adjust the Mic gain.

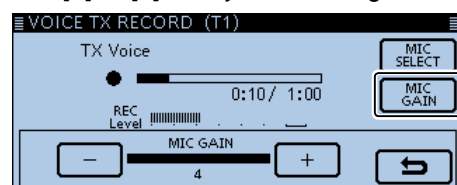

Voice TX function (Continued)

◇ Transmitting the recorded voice audio

NOTE: Be sure to first insert an SD card that has the recorded audio memory into the transceiver.

- ① Touch the Function group icon one or more times.
 - Selects the F-2 menu.
- ② Touch [VOICE].
 - Opens the voice memory window.

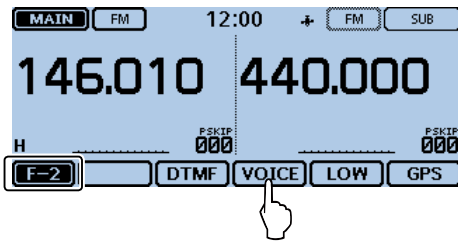

- ③ Touch a desired memory, [T1] through [T4] to transmit the recorded voice audio once.
 - If you touch [VOICE] again, the voice transmission will be canceled.
 - Push [PTT] to cancel a recorded voice transmission.

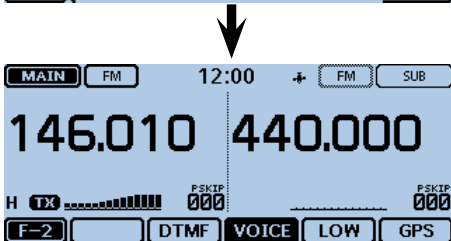
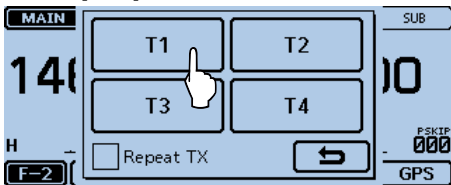

◇ Changing the voice TX settings

You can change the voice TX settings in the “TX SET” item of the Menu screen. See page 12-19 for details.

• Setting the Repeat Time

Set the repeat interval for the voice repeat transmission.

[MENU] > Voice TX > TX Set> Repeat Time

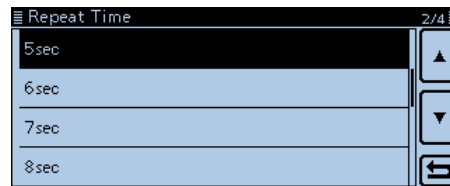

The transceiver repeatedly transmits the recorded voice audio at 5 second intervals as the default.

• Using the TX Monitor function

Turn the TX Monitor function ON or OFF. (Default: ON)

[MENU] > Voice TX > TX Set> TX Monitor

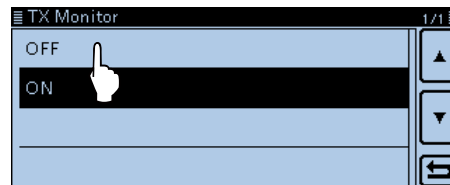

The TX voice audio is output from the speaker as the default.

For your reference:

- If you touch “Repeat TX” to insert a check in step ③ (Repeat TX), the transceiver repeatedly transmits the recorded voice audio for up to 10 minutes at the interval specified in “Repeat Time.”
 - Once the repeat transmission has been made, the transceiver pauses until the end of the “Repeat Time,” then transmits again. After the second transmission, the Repeat TX function continues pausing, if receiving a signal, even if the Busy Lockout is ON.
 - But if the squelch is manually opened in the FM mode, the voice audio is repeatedly transmitted, according to the repeat time setting.
- You can send recorded voice audio in the Menu screen. In the “VOICE TX” screen, touch “<<TX>>” to display the voice memory window. (Voice TX > <<TX>>)

Speech function

The Speech function audibly announces the displayed frequency and operating mode in the VFO, Memory or Call channel modes, or caller station's call sign when using the DR function.

◇ Using the Speech function

- When you push [⏏](SPEECH), the Speech function audibly announces the displayed frequency and operating mode, or the call sign selected in the MAIN band.
- When you receive a signal in the DV mode, the Speech function audibly announces the caller station's call sign.
- When you touch [RX>CS] for 1 second, and then release it, the Speech function audibly announces the station call sign set in the "TO" field.

NOTE:

- When you receive a signal during an announcement, the transceiver cancels the announcement, and you can hear the received audio.
- If a call is received during an announcement in the DV mode, the received audio will be muted. If you are recording the audio, no audio is recorded onto the SD card. In a mode other than the DV mode, the received audio will be recorded, even during an announcement.

The detailed settings for the Speech functions

You can set the detailed settings for the Speech functions in the Menu screen.

- **RX Call Sign SPEECH** (p. 12-46)
Set the RX call sign speech function for calls received in the DV mode.
(SPEECH > **RX Call Sign SPEECH**)
- **RX>CS SPEECH** (p. 12-46)
Set the RX>CS Speech function that announces the call sign set in the "TO" field when touching [RX>CS].
(SPEECH > **RX>CS SPEECH**)
- **DIAL SPEECH** (p. 12-46)
Set the Dial Speech function that announces the frequency or repeater call sign that is selected by rotating [DIAL].
(SPEECH > **DIAL SPEECH**)
- **MODE SPEECH** (p. 12-46)
Set the Operating Mode Speech function that announces the selected operating mode.
(SPEECH > **MODE SPEECH**)
- **SPEECH Language** (p. 12-46)
Set the speech language to English or Japanese.
(SPEECH > **SPEECH Language**)
- **Alphabet** (p. 12-47)
Set the Alphabet character announcement to either "Normal" or "Phonetic Code."
(SPEECH > **Alphabet**)
- **SPEECH Speed** (p. 12-47)
Set the speech speed to Low (slow) or High (fast).
(SPEECH > **SPEECH Speed**)
- **SPEECH Level** (p. 12-47)
Enter a volume level number between 0 (minimum) and 9 (maximum) for the voice synthesizer.
(SPEECH > **SPEECH Level**)

Using the DTMF memory

The transceiver can store up to 16 memory channels of 24-digit DTMF code.

◇ Entering DTMF code

- ① Touch [MENU].
- ② Touch “DTMF Memory.”
(DTMF > **DTMF Memory**)
 - If the item is not displayed, touch [▲] or [▼] one or more times to select another page.
 - Displays the DTMF memory channel list (d0 to d#).



- ③ Touch the desired DTMF memory channel.

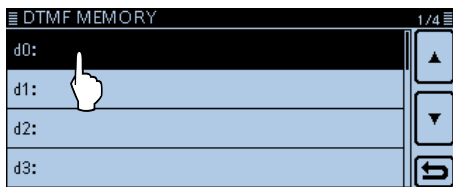

- ④ Enter the desired DTMF code.

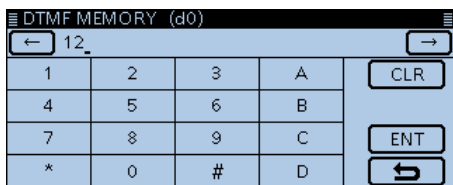

- Touch [←] to move the cursor backwards, or touch [→] to move the cursor forwards.
- Touch [CLR] to delete the selected character, symbol or number.

- ⑤ After entering, touch [ENT].
 - Saves the channel, and returns to the “DTMF MEMORY” screen.

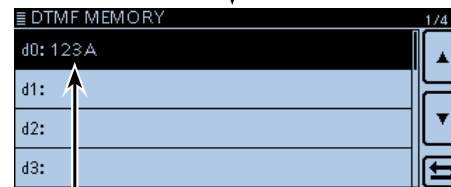
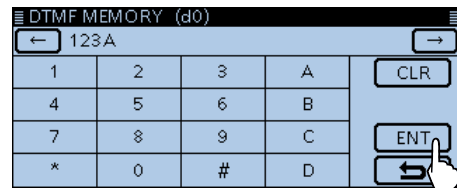

Stored DTMF code

- ⑥ Touch [MENU].
 - Closes the Menu screen.

You can clear the entered DTMF code. Touch the DTMF memory channel for 1 second in step ⑤, and then touch “Clear.”

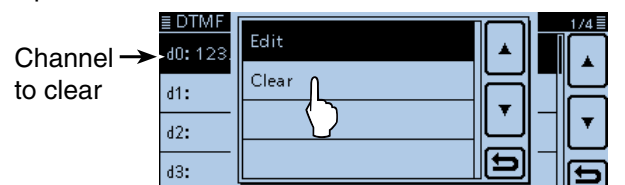

Using the DTMF memory (Continued)

◆ Transmitting DTMF code

- ① Touch the Function group icon one or more times.
 - Selects the F-2 menu.
- ② Touch [DTMF].
 - Displays the DTMF memory channel list.

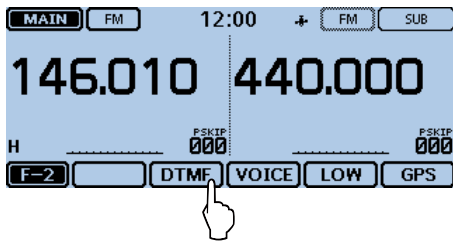

- ③ Touch the desired DTMF memory channel to transmit.

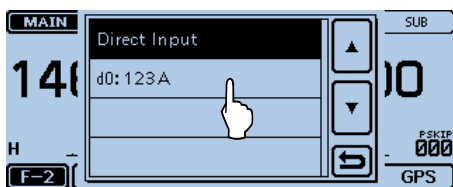

- The selected DTMF code is transmitted.

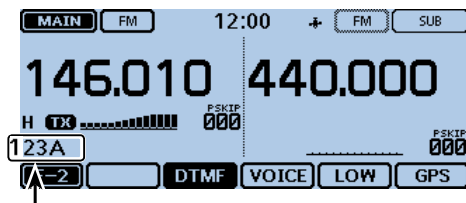

The DTMF code scrolls during transmission.

◆ Transmitting DTMF code (Direct Input)

- ① Touch the Function group icon one or more times.
 - Selects the F-2 menu.
- ② Touch [DTMF].

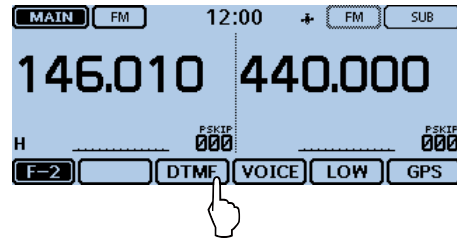

- ③ Touch "Direct Input."

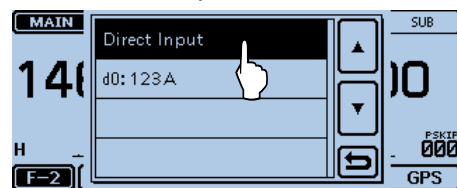

- ④ Enter the desired DTMF code.

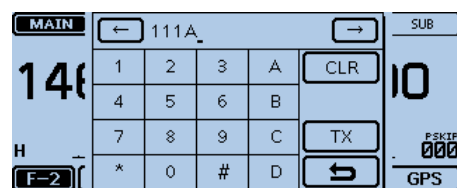

- Touch [←] to move the cursor backwards, or touch [→] to move the cursor forwards.
- Touch [CLR] to delete the selected character, symbol or number.

- ⑤ After entering all digits, touch [TX] or push [PTT].

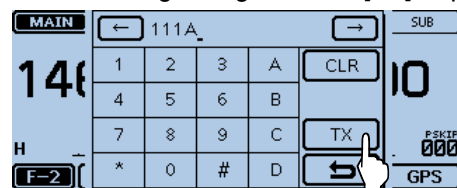

- The DTMF code is transmitted.

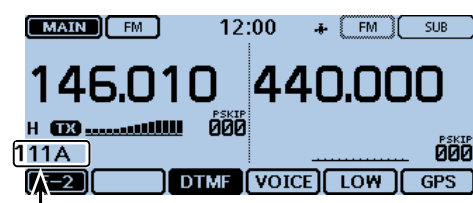

The DTMF code scrolls during transmission.

For your reference:
While transmitting, touching [DTMF] or the scrolling code cancels the transmission.

Using the DTMF memory (Continued)

◇ Setting the DTMF transmit speed

The DTMF transmit speed can be selected.

- ① Touch [MENU].
- ② Touch “DTMF Speed.”
(DTMF > **DTMF Speed**)
 - If the item is not displayed, touch [▲] or [▼] one or more times to select another page.
 - Opens the “DTMF Speed” screen.
- ③ Touch a desired transmit speed.
 - 100ms: Transmits the DTMF tones at about 100 milliseconds per code.
5 characters per second.
 - 200ms: Transmits the DTMF tones at about 200 milliseconds per code.
2.5 characters per second.
 - 300ms: Transmits the DTMF tones at about 300 milliseconds per code.
1.6 characters per second.
 - 500ms: Transmits the DTMF tones at about 500 milliseconds per code.
1 character per second.
- ④ Touch [MENU].
 - Closes the Menu screen.

[Image of the DTMF transmit speed]

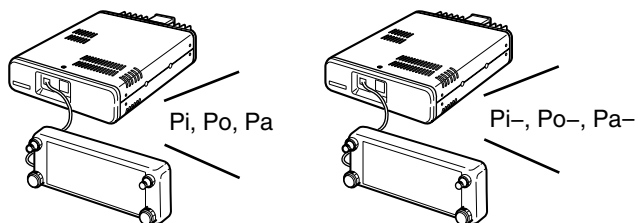

When “100ms” is set, the DTMF transmit speed is fast.

When “500ms” is set, the DTMF transmit speed is slow.

Tone squelch operation

The tone squelch opens only when you receive a signal containing a matching subaudible tone in the FM or FM narrow mode. You can silently wait for calls from others using the same tone.

Also, the reversed tone squelch function will mute the squelch when a signal containing a matched subaudible tone.

◆ Tone squelch frequency setting and operation

1. Setting the tone squelch frequency

- ① Select the VFO mode.
- ② Select FM or FM-N (FM narrow) mode.
- ③ Rotate [DIAL] to select a desired operating frequency.

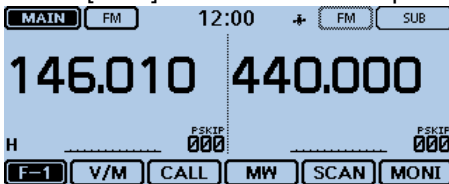

- ④ Touch [MENU].
- ⑤ Touch "TSQL Freq."
(DUP/TONE... > TSQL Freq)
 - If the item is not displayed, touch [▲] or [▼] one or more times to select another page.
 - Opens the "TSQL Freq" screen.

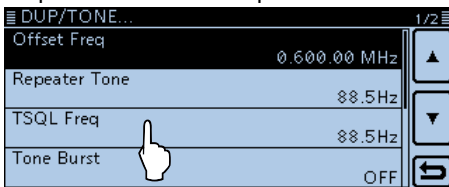

- ⑥ Touch [+] or [-] to enter a desired tone squelch frequency, and then touch [↵].
 - Select a tone squelch frequency between 67.0 to 254.1 Hz.

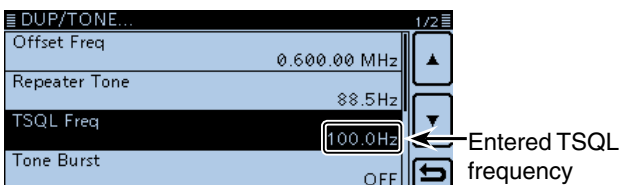
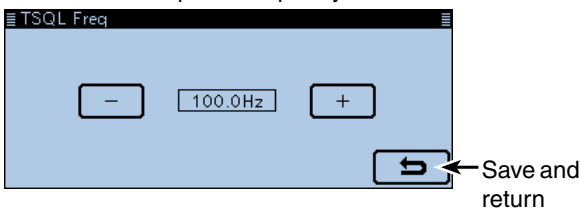

- ⑦ Touch [MENU].
 - Closes the Menu screen.

2. Using the tone squelch

- ⑧ Touch the Function group icon one or more times.
 - Selects the F-3 menu.
- ⑨ Touch [TONE].

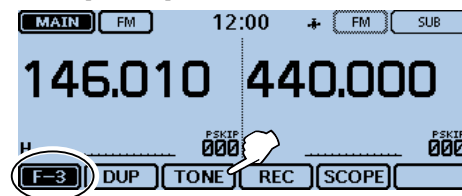

- ⑩ Touch the desired tone squelch type.
 - TSQL ((·)): The tone squelch with the pocket beep function is ON.
 - TSQL: The tone squelch function is ON.
 - TSQL-R: The reverse tone squelch function is ON.

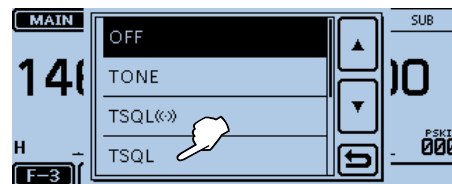

- "TSQL" is displayed when the tone squelch is ON. ("TSQL-R" is displayed when the reverse tone squelch is ON.)

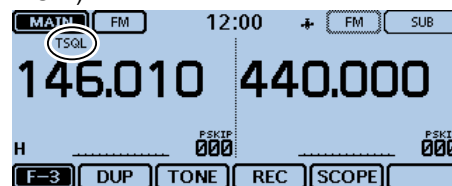

- ⑪ Holding down [PTT] and call a desired station. Operate normally.

Beeps sound when a call is received.
 If "TSQL ((·))" is selected in step ⑩, beeps sound for 30 seconds and the icon "((·))" blinks when a call with the matched tone signal is received.
 ➔ Within 30 seconds, push [PTT] to answer, or touch the screen to stop the beeps. ("((·))" disappears) After that, the transceiver selects the regular tone squelch operation.
 If you make no operation for 30 seconds, the beeps automatically stop, but "((·))" continues to blink to indicate that you received a call.

DTCS squelch operation

The tone squelch opens only when you receive a signal containing a matching DTCS code in the FM or FM narrow mode. You can silently wait for calls from others using the same tone. Also, a reversed tone squelch function will mute the squelch when you receive a signal containing a matched DTCS code.

◇ DTCS code setting and operation

1. Setting the DTCS code

- ① Select the VFO mode.
- ② Select FM or FM-N (FM narrow) mode.
- ③ Rotate [DIAL] to select a desired operating frequency.

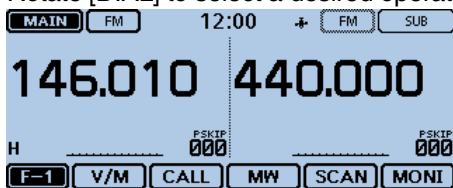

- ④ Touch [MENU].
- ⑤ Touch "DTCS Code."
(DUP/TONE... > DTCS Code)
 - If the item is not displayed, touch [▲] or [▼] one or more times to select another page.
 - Opens the "DTCS Code" screen.

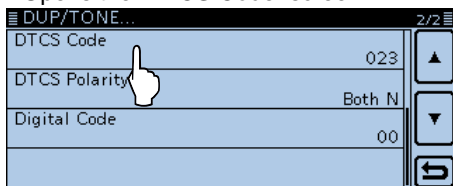

- ⑥ Touch [+] or [-] to enter a desired tone squelch frequency, and then touch [↵].
 - Select a DTCS code between 023 to 754.

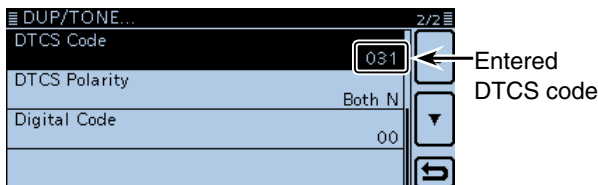
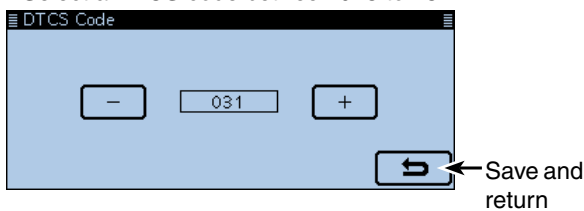

- ⑦ Touch [MENU].
 - Closes the Menu screen.

2. The DTCS code operation

- ⑧ Touch the Function group icon one or more times.
 - Selects the F-3 menu.
- ⑨ Touch [TONE].

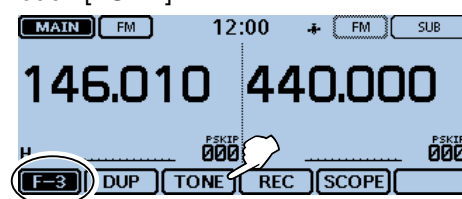

- ⑩ Touch the desired DTCS code type.
 - DTCS((·)): The DTCS squelch with the pocket beep function is ON.
 - DTCS: The DTCS squelch function is ON.
 - DTCS-R: The reverse DTCS squelch function is ON.

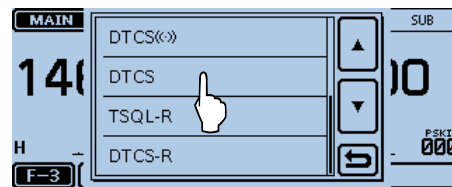

- "DTCS" is displayed when the DTCS squelch is ON.
- ("DTCS-R" is displayed when the reverse DTCS squelch is ON.)

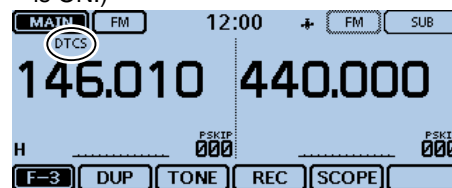

- ⑪ Holding down [PTT] and call a desired station. Operate normally.

Beeps sound when a call is received.
 If "DTCS((·))" is selected in step ⑩, beeps sound for 30 seconds and the icon "((·))" blinks when a call with the matched DTCS code signal is received.
 ➔ Within 30 seconds, push [PTT] to answer, or touch the screen to stop the beeps. ("((·))" disappears) After that, the transceiver selects the regular DTCS squelch operation.
 If you make no operation for 30 seconds, the beeps automatically stop, but "((·))" continues to blink to indicate that you received a call.

Weather channel operation (USA version only)

There are 10 weather channels for monitoring the NOAA (National Oceanographic and Atmospheric Administration) weather broadcasts.

◇ Weather channel selection

- ① Touch [QUICK].
- ② Touch "Weather CH" to select the Weather channel mode.
 - The selected weather channel number ("WX-01" to "WX-10") is displayed.

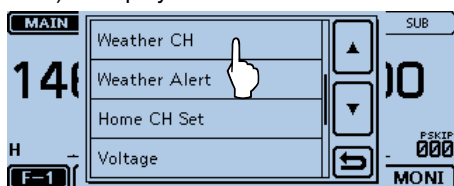

- ③ Rotate [DIAL] to select the desired weather channel.
 - Touch "Weather CH OFF" on the Quick Menu screen to return to the previous frequency or Memory channel.

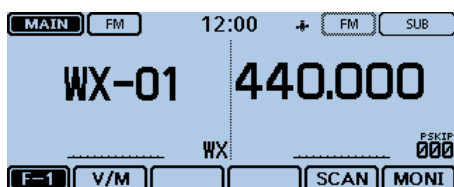

◇ Weather alert function

NOAA broadcast stations transmit weather alert tones before important weather announcements.

When the weather alert function is turned ON, the selected weather channel is monitored every 5 seconds for an announcement.

When an alert signal is detected, the "ALT" and the WX channel are alternately displayed, and a beep sounds until you change the operating mode or weather channel, turn OFF the Weather Alert function, or turn OFF the transceiver.

The previously selected (used) weather channel is checked periodically during standby, or while scanning.

- ① Touch [QUICK].
- ② Touch "Weather Alert."
 - If the item is not displayed, touch [▲] or [▼] one or more times to select the page.

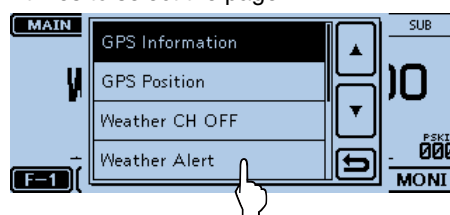

- ③ Touch "ON."
 - Turns ON the Weather Alert function.

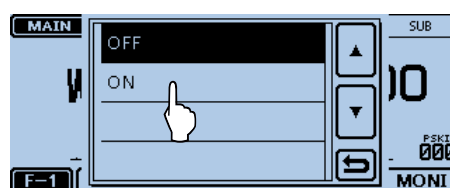

- ④ Select the VFO, a Memory or Call channel to set the desired standby mode.
 - "WX" appears when "ON" is selected in step ③.
 - Scan or priority watch operation can also be selected.

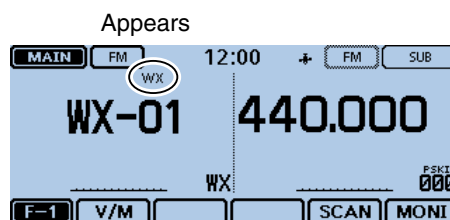

Repeater mode operation (USA version only)

When you receive an FM (or FM-N) signal in the Repeater mode on one band, the transceiver automatically retransmits them on the other band. This is called Cross-Band repeater operation.

NOTE: Use this function carefully according to the applicable laws and ordinances.

◇ Entering the Repeater mode

- ① Touch [MENU].
- ② Touch "Repeater Mode."
(Others > **Repeater Mode**)
 - If the item is not displayed, touch [▲] or [▼] one or more times to select another page.
- ③ Touch "<<Repeater Mode>>".
 - "Enter the Repeater Mode?" appears.
- ④ Touch [YES].
 - Enters the Repeater mode.

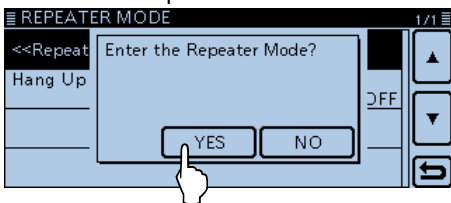

- In the Repeater mode, [RPT] blinks instead of the Function group icon.

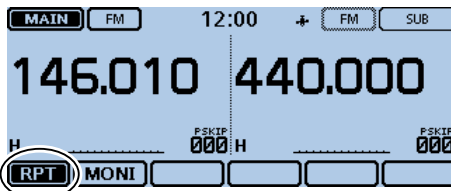

Blinks

NOTE:

- You cannot enter the Repeater mode when:
- The AM, AM-N or DV mode is set.
 - Single band operation is set.
 - The frequency is out of the Ham band.

◇ Exiting the Repeater mode

- ① Touch [RPT].
 - "Exit Repeater Mode?" appears.
- ② Touch [YES].

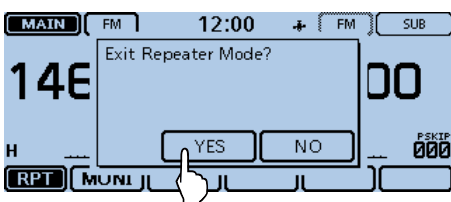

◇ Cross-Band repeater operation

- "BUSY" appears and the S-meter displays the relative signal strength level on the receiving band display.
- The S/R/F meter displays the output power level, and "TX" blinks on the transmitting band display.

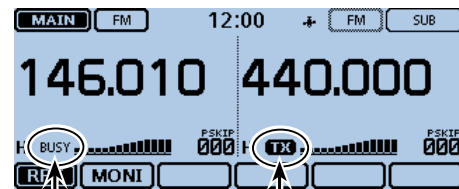

Appears

Blinks

Transmission is automatically cancelled according to the "Hang Up Time" item setting.

When the "Hang Up Time" item is set to OFF, the transceiver cancels the transmission when the receive signal disappears.

When the "Hang Up Time" item is set to ON, the transceiver cancels the transmission approximately 0.25 seconds after the receive signal disappears.

You can set the "Hang Up Time" item in the Menu screen. (p. 12-67)

For your reference:

- In the Repeater mode, the function menu displays only [MONI].
Touching [MONI] turns the Monitor function ON or OFF.
When the Monitor function is ON, "BUSY" blinks, and the squelch opens to receive signals on the MAIN band.
- When you hold down [PTT] in the Repeater mode, the signal is transmitted on the MAIN band.
- You cannot use a Bluetooth® headset.

NOTE:

- In the Repeater mode, you cannot enter the Clone mode.
- Even if the transceiver is turned OFF, the Repeater mode is not canceled.

Cloning function

The ID-5100A/E has a data cloning capability. This function is useful when you want to copy all of the programmed contents from one ID-5100A/E to another. Cloning can also be done with a PC.

• **Transceiver-to-Transceiver cloning using an SD card** (described on this page)

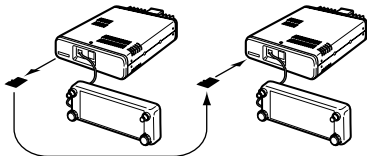

• **Cloning from a PC using an SD card** (see page 13-15)

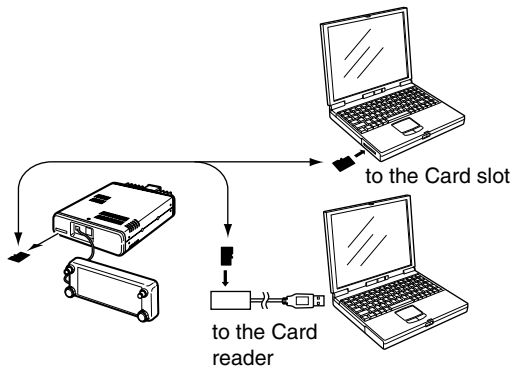

• **Cloning from a PC using an optional cloning cable** (see page 13-15)

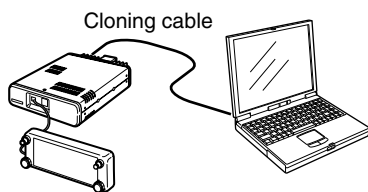

◇ **Transceiver-to-Transceiver cloning using an SD card**

This section describes the cloning method using an SD card. Memory channel contents, MENU item settings and repeater lists can be stored onto the SD card. Recorded voice memories are not included in the cloning data. To play back the master transceiver's voice memory, insert the SD card into a sub transceiver, or make a copy onto the sub transceiver's SD card using a PC.

- Assumes that the SD card has already been inserted into the transceiver.

1. Saving the master transceiver's setting data onto the SD card.

- ① Touch [MENU].
- ② Touch "Save Setting."
(SD Card > **Save Setting**)
 - If the item is not displayed, touch [▲] or [▼] one or more times to select another page.

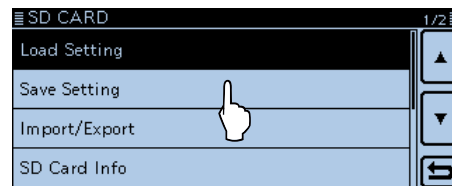

- ③ Touch "<<New File>>".
 - The "FILE NAME" screen is displayed.

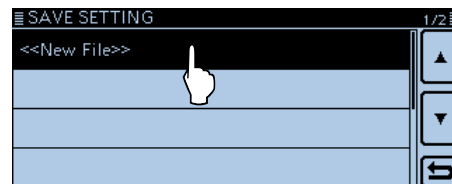

- ④ The file name is automatically named in the following manner:
 - "Setyyyyymmdd_xx" (yyyy:Year, mm:month, dd:day, xx: serial number)
 - If you want to change the file name, see "Save with a different file name." (p. 9-7)

- ⑤ Touch [ENT].

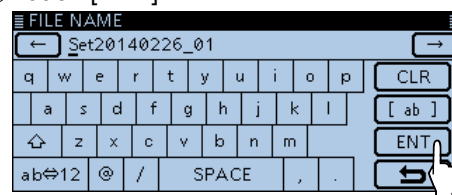

☞ Continued on the next page

Cloning function

◇ Transceiver-to-Transceiver cloning using an SD card (Continued)

⑥ Touch [YES].

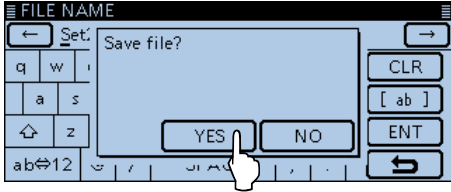

• While saving, a progress bar is displayed, and then the “SD CARD” screen is displayed after the save is completed.

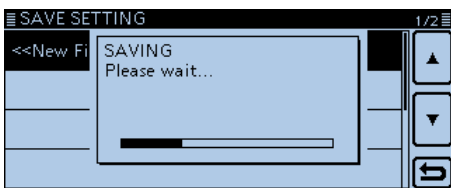

⑦ Touch [MENU].

• Closes the Menu screen.

2. Remove the SD card from the master transceiver, and then insert it into the sub transceiver.

⑧ Hold down the master transceiver’s [⏻] to turn OFF the power.

⑨ Remove the SD card from the master transceiver.

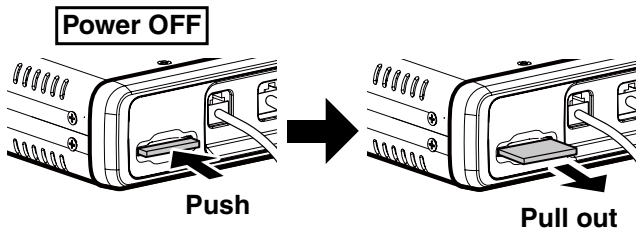

Push in the SD card until a click sounds.

⑩ Insert the SD card into the sub transceiver, then hold down the sub transceiver’s [⏻] to turn ON the power.

NEVER forcibly or inversely insert the card. It will damage the card and/or the slot.

3. Loading the setting data into the sub transceiver.

⑪ Touch [MENU].

⑫ Touch “Load Setting.”

(SD Card > Load Setting)

• If the item is not displayed, touch [▲] or [▼] one or more times to select another page.

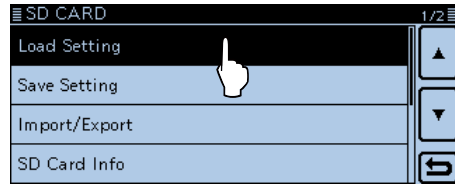

⑬ Touch the desired setting file.

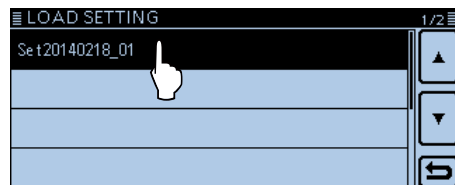

⑭ Touch the desired content to load it.

- ALL: Loads all memory channels, item settings in the menu list and the repeater list into the transceiver.
- Except My Station: Loads all memory channels, the repeater list, and item settings in the Menu screen except MY call signs, into the transceiver.
- Repeater List Only: Loads only the repeater list into the transceiver.

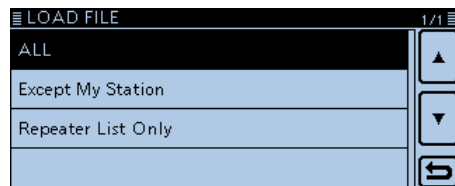

• The “Keep ‘SKIP’ setting in Repeater List?” appears.

⑮ Touch “YES” or “NO.”

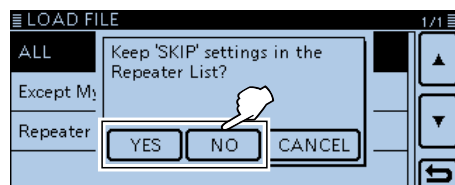

• When “Yes” is selected, the skip setting of the repeater list is retained. (p. 7-29)

Cloning function

◇ Transceiver-to-Transceiver cloning using an SD card (Continued)

⑩ Touch [Yes].

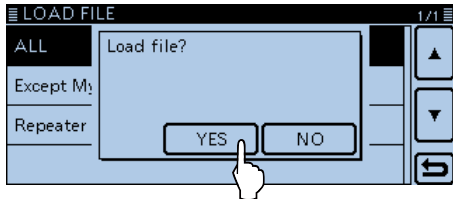

- While checking the file, "FILE CHECKING" and a progress bar are displayed.

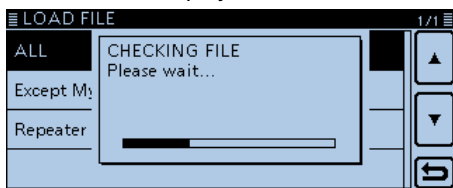

⑪ After checking, settings data loading starts.

- While loading, "LOADING" and a progress bar are displayed.

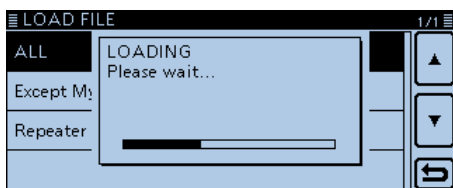

⑫ After loading, "COMPLETED!" appears.

To complete the loading, reboot the transceiver.

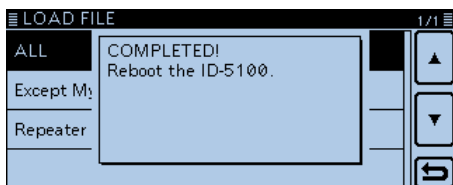

Cloning function (Continued)

◇ **Cloning from a PC using an SD card**

You can clone transceivers from a PC using an SD card.

Set memory content, Menu item settings and repeater list in the CS-5100 cloning software (contained in the CD), and save them in an “icf” file format. Copy the “icf” file to the “Setting” folder in the “ID-5100” folder of the SD card.

• **SD card configuration**

Insert the SD card that includes the “icf” file, then load it to complete the cloning.

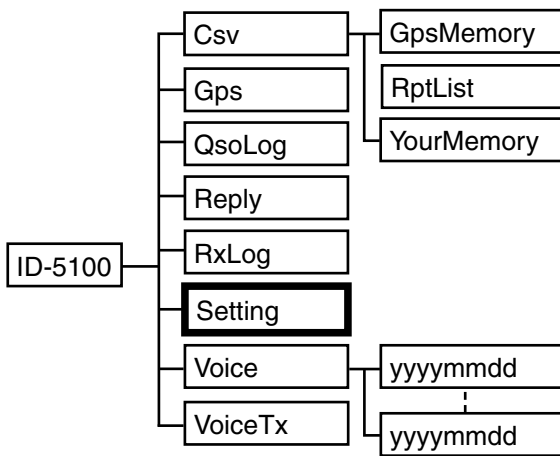

• **Connections**

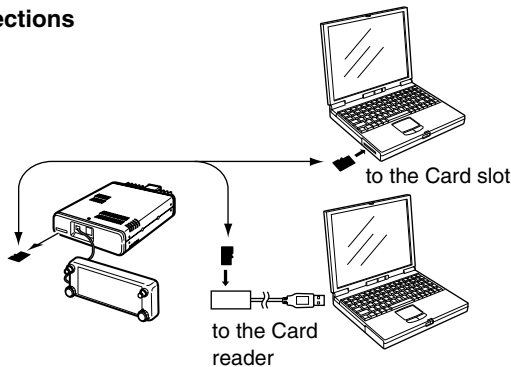

◇ **Cloning from a PC using an optional cloning cable**

You can clone with the CS-5100 (contained in the CD) and the optional OPC-2218LU, OPC-1529R or OPC-478UC.

See the CS-5100 instruction manual (contained in the CD) and the OPC-2218LU or OPC-478UC instruction manual (downloaded from the Icom WEB site; <http://www.icom.co.jp/world/>)

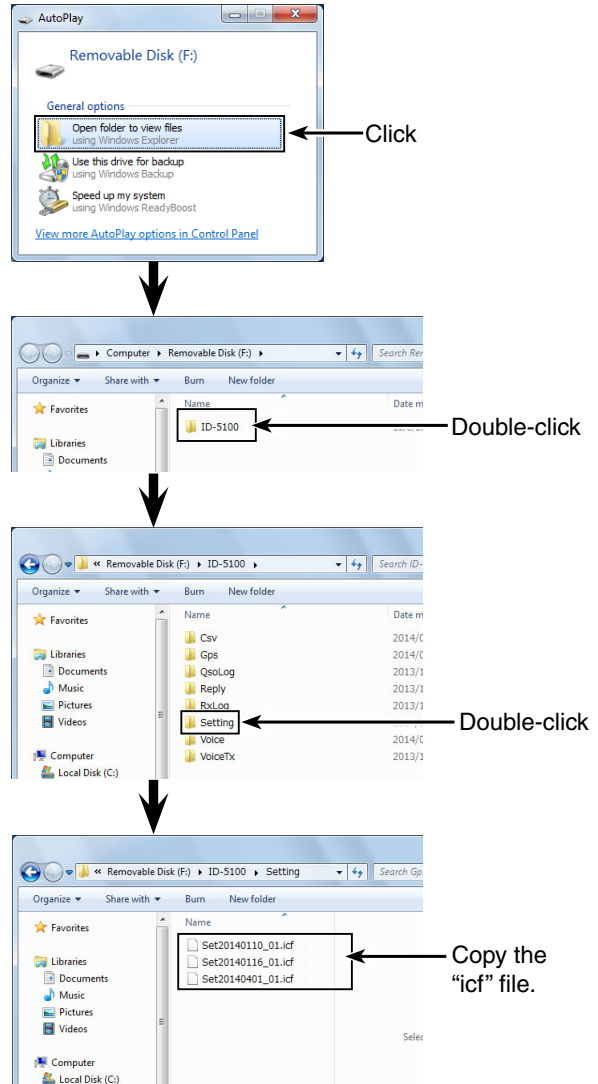
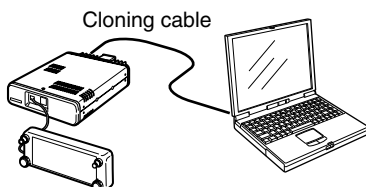

NOTE:
 When using the OPC-2218LU or OPC-1529R, set the “DV Data TX” item to “PTT,” before cloning.
 If “Auto” is set, the transceiver may automatically transmit with the cloning data.
 (DV Set > DV Data TX)

Remote jack (CI-V) information

◆ CI-V connection example

The transceiver can be connected through an optional CT-17 CI-V LEVEL CONVERTER to a PC equipped with an RS-232C port. The Icom Communications Interface-V (CI-V) controls the transceiver.

Up to 4 Icom CI-V transceivers or receivers can be connected to the PC. See page 12-56 for setting the CI-V condition using the set mode.

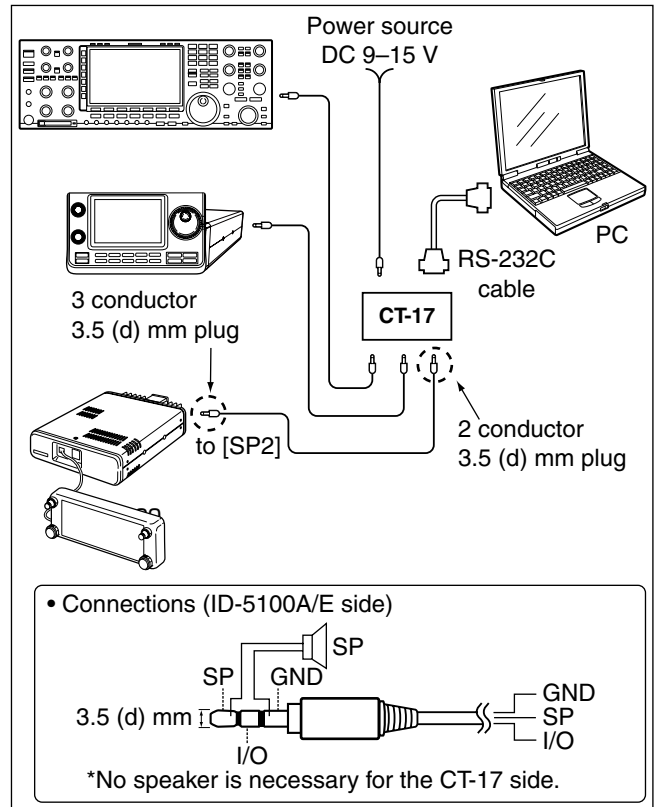

◆ Data format

The CI-V system uses the following data formats. Data formats differ depending on command numbers. A data area or sub command is added to some commands.

Controller to ID-5100A/E

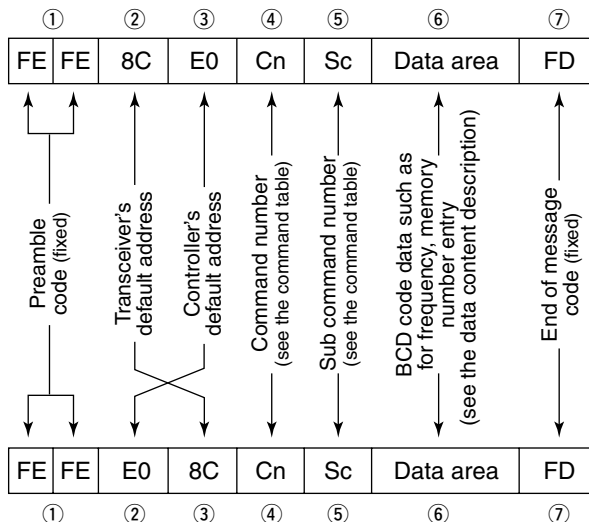

ID-5100A/E to controller

OK message to controller

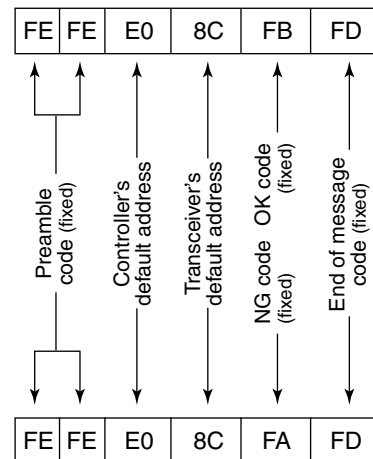

NG message to controller

Remote jack (CI-V) information (Continued)

◇ Command table

Cmd.	Sub cmd.	Data	Description
00		see p. 13-18	Send operating frequency for transceiver
01		see p. 13-18	Send operating mode for transceiver
03		see p. 13-18	Read operating frequency
04		see p. 13-18	Read operating mode
05		see p. 13-18	Send operating frequency
06		see p. 13-18	Send operating mode
07	D0		Select A band Dualwatch: Set the Main band as the A band Single watch: Select the A band
	D1		Select B band Dualwatch: Set the Main band as the B band Single watch: Select the B band
0C		see p. 13-18	Read frequency offset*1
0D		see p. 13-18	Send frequency offset
0F			Read duplex setting (10=simplex, 11=DUP-, 12=DUP+)
	10		Set simplex operation
	11		Set DUP- operation
	12		Set DUP+ operation
14	01	0000 to 0255	Send/read audio output level (000=Minimum, 0128=Center, 0255=Maximum)
	03	0000 to 0255	Send/read squelch level (000=Minimum, 0128=Center, 0255=Maximum)
	0A	see p. 13-18	Send/read RF power setting
	0B	see p. 13-18	Send/read external microphone gain.
	16	see p. 13-18	Send/read VOX gain.
15	01	00	Read noise/S-meter squelch status (squelch close)
		01	Read noise/S-meter squelch status (squelch open)
	02	0000 to 0255	Read S-meter level (0000=S0, 0170=S9)
	05	00	Read tone squelch and RF squelch status (squelch close)
		01	Read tone squelch and RF squelch status (squelch open)
11	0000 to 0255	Read RF power meter (0026=LOW, 0077=MID, 0255=HIGH)	
16	42	00	Send/read Repeater tone OFF
		01	Send/read Repeater tone ON
	43	00	Send/read Tone squelch OFF
		01	Send/read Tone squelch ON
		02	Send/read Reversed Tone squelch ON
	46	00	Send/read VOX function OFF
		01	Send/read VOX function ON
	4B	00	Send/read DTCS OFF
		01	Send/read DTCS ON
		02	Send/read Reversed DTCS ON
	59	00	Send/read single watch mode
		01	Send/read Dualwatch mode
	5B	00	Send/read DSQL/CSQL OFF (DV mode only)
		01	Send/read DSQL ON (DV mode only)
		02	Send/read CSQL ON (DV mode only)
5C	00, 01, 02	00	Send/read GPS TX mode (00=OFF, 01=D-PRS, 02=NMEA)
		01	Send/read GPS TX mode (00=OFF, 01=D-PRS, 02=NMEA)
18	00	Turning the transceiver power OFF	
	01	Turning the transceiver power ON*2	
19	00	Read transceiver ID	
1B	00	see p. 13-18	Send/read Repeater tone frequency
	01	see p. 13-18	Send/read Tone squelch frequency
	02	see p. 13-18	Send/read DTCS code and polarity
	07	see p. 13-18	Send/read CSQL code (DV mode)
1C	00	00	Send/read Transceiver's status (RX)
		01	Send/read Transceiver's status (TX)

Cmd.	Sub cmd.	Data	Description	
1F	00	see p. 13-18	Send/read DV MY call sign	
	01	see p. 13-19	Send/read DV TX call signs	
	02	see p. 13-19	Send/read DV TX message	
20	00	00*3	Send/read Auto DV RX Call signs output OFF	
		01*3	Send/read Auto DV RX Call signs output ON	
		01	see p. 13-19	Output DV RX Call signs for transceiver
		02	see p. 13-19	Read DV RX Call signs for transceiver
	01	00	00*3	Send/read Auto DV RX message output OFF
			01*3	Send/read Auto DV RX message output ON
		01	see p. 13-20	Output DV RX message for transceiver
		02	see p. 13-20	Read DV RX message for transceiver
	02	00	00*3	Send/read Auto DV RX status output OFF
			01*3	Send/read Auto DV RX status output ON
		01	see p. 13-20	Output DV RX status for transceiver
		02	see p. 13-20	Read DV RX status for transceiver
03	00	00	Send/read Auto DV RX GPS/D-PRS data output OFF	
		01	Send/read Auto DV RX GPS/D-PRS data output ON	
	01	see p. 13-20	Output DV RX GPS/D-PRS data for transceiver	
	02	see p. 13-20	Read DV RX GPS/D-PRS data for transceiver	
04	00	00	Send/read Auto DV RX GPS/D-PRS message output OFF	
		01	Send/read Auto DV RX GPS/D-PRS message output ON	
	01	see p. 13-22	Output DV RX GPS/D-PRS message for transceiver	
	02	see p. 13-22	Read DV RX GPS/D-PRS message for transceiver	
22	00	see p. 13-22	Send/read DV TX data (Up to 30 byte)	
	01	00	Send/read Auto DV RX data output OFF	
		01	Send/read Auto DV RX data output ON	
	01	see p. 13-22	Send/read DV RX data (Up to 30 byte)	
02		00, 01	Send/read DV data TX setting (00=PTT, 01=Auto)	
23	00	see p. 13-22	Read the position	
	01	00	Send/read the internal GPS OFF	
		01	Send/read the internal GPS ON	
		03	Send/read the manual input	
02	see p. 13-22	Send/read manually input position		
24	00	00	Send/read TX output power setting OFF	
		01	Send/read TX output power setting ON	
	01	00	TX output power setting OFF for transceiver	
		01	TX output power setting ON for transceiver	

*1Below 100 Hz is omitted.

*2When sending the power ON command (18 01), the command "FE" must be sent before the basic format.

• 19200bps: 25 • 9600bps: 13 • 4800bps: 7

e.g.: When operating with 4800 bps

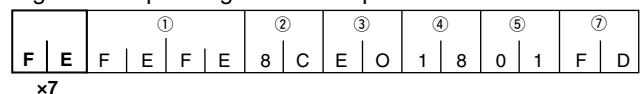

- ① Preamble code (fixed)
- ② Transceiver's default address
- ③ Controller's default address
- ④ Command number
- ⑤ Sub command number
- ⑦ End of message code (fixed)

*3Output setting is automatically turned OFF after turning the power OFF, then ON.

Remote jack (CI-V) information (Continued)

• Receive frequency setting

Command: 00, 03, 05

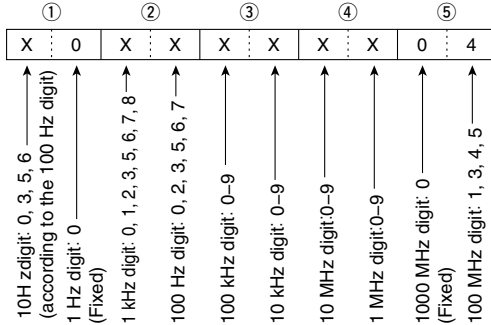

100 Hz digit	10 Hz digit
0	0
2	5
3	3
5	0
6	6
7	5

• Operating mode

Command: 01, 04, 06

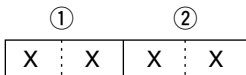

Operating mode	① Mode	② Filter setting
AM	02	01
AM-N	02	02
FM	05	01
FM-N	05	02
DV	17	01

• Duplex Frequency offset setting

Command: 0C, 0D

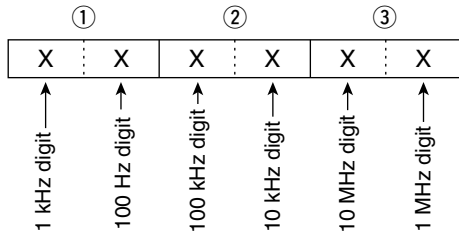

• RF power level setting

Command: 14 0A

LOW	MID	HIGH
0000-0026	0027-0127	0128-0255

• External microphone gain setting

Command: 14 0B

1	2	3	4
0000-0063	0064-0127	0128-0191	0192-0255

• VOX gain setting

Command: 14 16

OFF	1	2	3	4
0000-0022	0023-0046	0047-0069	0070-0092	0093-0115
5	6	7	8	9
0016-0139	0140-0162	0163-0185	0186-0208	0209-0232
10				
0233-0255				

• Repeater tone/tone squelch frequency setting

Command: 1B 00, 1B 01

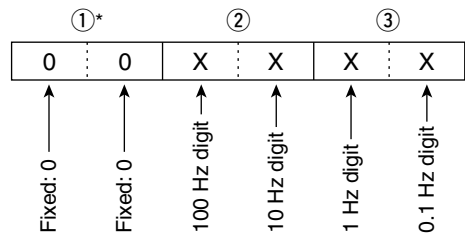

*Not necessary when setting a frequency.

• DTCS code and polarity setting

Command: 1B 02

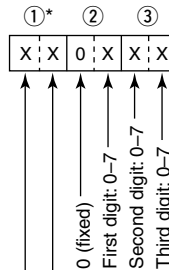

Receive polarity: 0: Normal
1: Reverse
Transmit polarity: 0: Normal
1: Reverse

• Digital code squelch setting

Command: 1B 07

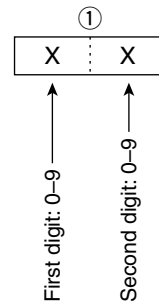

• DV MY call sign setting

Command: 1F 00

Set your own call sign and note of up to 12 characters.

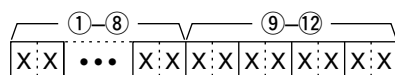

①-⑧: Your own call sign setting (8 characters)

⑨-⑫: Note setting (4 characters)

Remote jack (CI-V) information (Continued)

• DV TX call signs setting (24 characters)

Command: 1F 01

Set "UR," "R1" and "R2" call signs of 8 characters (fixed).

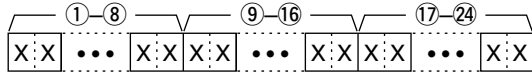

- ①–⑧: UR (Destination) call sign setting (8 characters)
- ⑨–⑯: R1 (Access/Area repeater) call sign setting (8 characters)
- ⑰–⑳: R2 (Link/Gateway repeater) call sign setting (8 characters)

• Character's code of the call sign

Character	ASCII code
0–9	30–39
A–Z	41–5A
(Space)	20
/	2F

• DV TX message setting

Command: 1F 02

Set the transmit message of up to 20 characters. "FF" stops sending or reading messages.

Character	ASCII code	Character	ASCII code
A–Z	41–5A	a–z	61–7A
0–9	30–39	Space	20
!	21	#	23
\$	24	%	25
&	26	\	5C
?	3F	"	22
'	27	`	60
^	5E	+	2B
–	2D	*	2A
/	2F	.	2E
,	2C	:	3A
:	3B	=	3D
<	3C	>	3E
(28)	29
[5B]	5D
{	7B	}	7D
!	7C		5F
-	7E	@	40

• DV RX call sign data

Command: 20 0001, 20 0002

① Header flag data (First byte)

Data		Description
bit7	(0 :Fixed)	—
bit6	(0 :Fixed)	
bit5	(0 :Fixed)	
bit4	0/1	0=Voice, 1=Data
bit3	0/1	0=Direct, 1=Through repeater
bit2	0/1	0=No Break-in, 1=Break-in
bit1	0/1	0=Data, 1=Control
bit0	0/1	0=Normal, 1=EMR

② Header flag data (Second byte)

Data			Description
bit2	bit1	bit0	
1	1	1	Repeater control
1	1	0	Send auto acknowledge
1	0	1	(Not used)
1	0	0	Request to re-transmit
0	1	1	Send acknowledge
0	1	0	Receive no reply
0	0	1	Repeater disabled
0	0	0	NULL

- ③–⑩: Call sign of the caller station (8 characters; fixed)
- ⑪–⑭: Note of the caller station (4 characters; fixed)
- ⑮–⑳: Call sign of the called station (8 characters; fixed)
- ㉓–㉟: Call sign of the access/area repeater (R1) (8 characters; fixed)
- ㉫–㉟: Call sign of the link/gateway repeater (R2) (8 characters; fixed)
- "FF" stands for no call sign receiving after turning ON the transceiver.

Remote jack (CI-V) information (Continued)

• **DV RX message**

Command: 20 0101, 20 0102

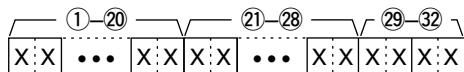

- ①—②①: Message (20 characters)
- ②①—②⑧: Call sign of the caller station (8 characters)
- ②⑨—③②: Note of the caller station (4 characters)

• FF: When no call sign is received since the transceiver power ON.

Example: When a Gateway call is received

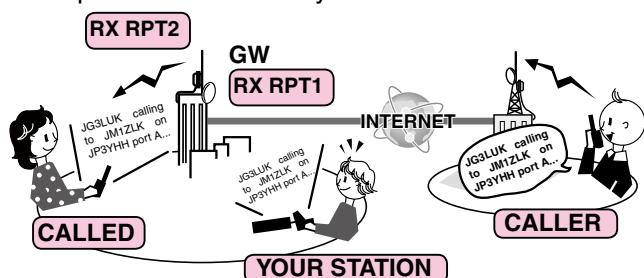

- CALLER: Caller's call sign
- CALLED: Called station call sign
- RXRPT1: Call sign of the repeater that was accessed by the caller station
 *If it was a call through a gateway and the internet, this item displays the gateway call sign of the repeater you received the call from.
- RXRPT2: Call sign of the repeater you received the call from

• **GPS/D-PRS data— Position**

Command: 20 0301, 20 0302

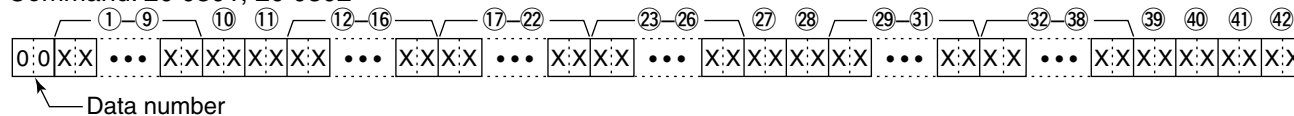

- ①—①: Call sign/SSID
 *9 ASCII characters (A–Z, 0–9, /, -, space)
- ①①, ①①: Symbol
 *2 ASCII characters (00h–EFh)
- ①②—①⑥: Latitude (dd°mm.mmm format)
- ①⑦—①②: Longitude (ddd°mm.mmm format)
- ①③—①⑥: Altitude (0.1 meter steps)
- ①⑦, ①⑧: Course (1 degree steps)
- ①⑨—①③: Speed (0.1 km/h steps)
- ①④—①⑧: Date (UTC: yyyyymmddHHMMSS)
 *y: Year, m: Month, d: Day, H: Hour, M: Minute, S: Second

• **DV RX Status setting**

Command: 20 0201, 20 0202

Data	Function	Description
bit7	0 (Fixed)	—
bit6	0/1 Receiving a voice call	During receiving a digital voice signal, select "1." (Regardless of DSQL and CSQL setting)
bit5	0/1 Last call finisher	When the last call was finished by you, select "1."
bit4	0/1 Receiving a signal	When the audio tone can be heard, select "1."
bit3	0/1 Receiving a BK call	During receiving a BK call, select "1."
bit2	0/1 Receiving a EMR call	During receiving a EMR call, select "1."
bit1	0/1 Receiving a signal other than DV	When "DV" and "FM" are blinking, select "1."
bit0	0/1 Packet loss status	During displaying a packet loss

- ①⑨: Power (see the table below)
- ①①: Height (see the table below)
- ①②: Gain (see the table below)
- ①③: Directivity (see the table below)

Data	Power (W)	Height (m/ft)	Gain (dB)	Directivity (deg)
0	0	3/10	0	Omni-direction
1	1	6/20	1	45° NE
2	4	12/40	2	90° E
3	9	24/80	3	135° SE
4	16	49/160	4	180° S
5	25	98/320	5	225° SW
6	36	195/640	6	270° W
7	49	390/1280	7	315° NW
8	64	780/2560	8	360° N
9	81	1561/5120	9	—

Remote jack (CI-V) information (Continued)

• GPS/D-PRS data— Object

Command: 20 0301, 20 0302

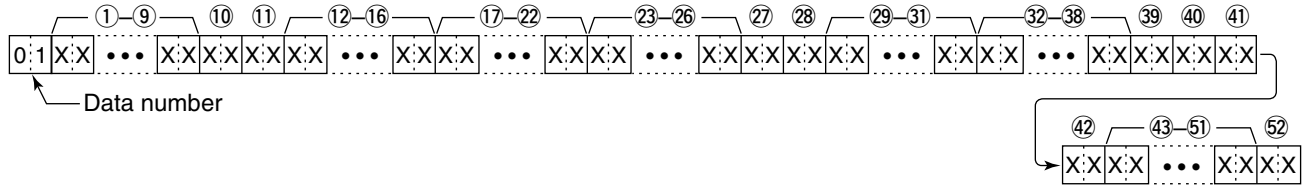

- ①–⑨: Call sign/SSID
*9 ASCII characters (A–Z, 0–9, /, -, space)
- ⑩, ⑪: Symbol
*2 ASCII characters (00h–EFh)
- ⑫–⑯: Latitude (dd°mm.mmm format)
- ⑰–⑳: Longitude (ddd°mm.mmm format)
- ㉓–㉖: Altitude (0.1 meter steps)
- ㉗, ㉘: Course (1 degree steps)
- ㉙–㉛: Speed (0.1 km/h steps)
- ㉜–㉟: Date (UTC: yyymmddHHMMSS)
*y: Year, m: Month, d: Day, H: Hour, M: Minute, S: Second
- ㊸: Power (see the table to the right)
- ㊹: Height (see the table to the right)
- ㊺: Gain (see the table to the right)
- ㊻: Directivity (see the table to the right)

	Power	Height	Gain	Directivity
Data	(W)	(m/ft)	(dB)	(deg)
0	0	3/10	0	Omni-direction
1	1	6/20	1	45° NE
2	4	12/40	2	90° E
3	9	24/80	3	135° SE
4	16	49/160	4	180° S
5	25	98/320	5	225° SW
6	36	195/640	6	270° W
7	49	390/1280	7	315° NW
8	64	780/2560	8	360° N
9	81	1561/5120	9	—

- ㉜–㉟: Name
*9 ASCII characters (00h–EFh)
- ㊻: Type (1=Live, 0=Killed)

• GPS/D-PRS data— Item

Command: 20 0301, 20 0302

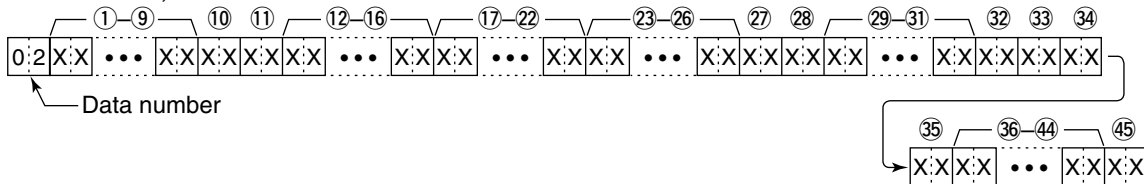

- ①–⑨: Call sign/SSID
*9 ASCII characters (A–Z, 0–9, /, -, space)
- ⑩, ⑪: Symbol
*2 ASCII characters (00h–EFh)
- ⑫–⑯: Latitude (dd°mm.mmm format)
- ⑰–⑳: Longitude (ddd°mm.mmm format)
- ㉓–㉖: Altitude (0.1 meter steps)
- ㉗, ㉘: Course (1 degree steps)
- ㉙–㉛: Speed (0.1 km/h steps)
- ㉜: Power (see the table to the right)
- ㉝: Height (see the table to the right)
- ㉞: Gain (see the table to the right)
- ㉟: Directivity (see the table to the right)

	Power	Height	Gain	Directivity
Data	(W)	(m/ft)	(dB)	(deg)
0	0	3/10	0	Omni-direction
1	1	6/20	1	45° NE
2	4	12/40	2	90° E
3	9	24/80	3	135° SE
4	16	49/160	4	180° S
5	25	98/320	5	225° SW
6	36	195/640	6	270° W
7	49	390/1280	7	315° NW
8	64	780/2560	8	360° N
9	81	1561/5120	9	—

- ㉜–㉟: Name
*9 ASCII characters (00h–EFh)
- ㊻: Type (1=Live, 0=Killed)

Remote jack (CI-V) information (Continued)

• **GPS/D-PRS data— Weather**

Command: 20 0301, 20 0302

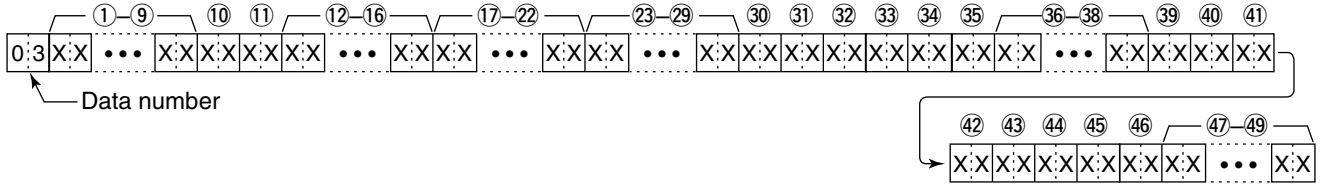

- ①-⑨: Call sign/SSID
*9 ASCII characters (A-Z, 0-9, /, -, space)
- ⑩, ⑪: Symbol
*2 ASCII characters (00h-EFh)
- ⑫-⑯: Latitude (dd°mm.mmm format)
- ⑰-⑳: Longitude (ddd°mm.mmm format)
- ㉓-㉙: Date (UTC: yyymmddHHMMSS)
*y: Year, m: Month, d: Day, H: Hour, M: Minute, S: Second

- ⑳, ㉑: Wind direction (1 degree steps)
- ㉒, ㉓: Wind speed (0.1 m/s steps)
- ㉔, ㉕: Gust speed (0.1 m/s steps)
- ㉖-㉗: Temperature (0.1°C steps)
- ㉘ : Temperature (0=+ degree, 1=- degree)
- ㉙, ㉚: Rainfall (0.1 mm steps)
- ㉛, ㉜: Rainfall (24 hours) (0.1 mm steps)
- ㉝, ㉞: Rainfall (Midnight) (0.1 mm steps)
- ㉟, ㊱: Humidity (1% steps)
- ㊲-㊴: Barometric pressure (0.1 hPa steps)

• **GPS/D-PRS message**

Command: 20 0401, 20 0402

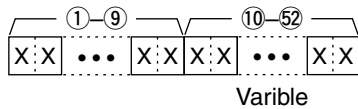

- ①-⑨: Call sign/SSID
*9 ASCII characters (A-Z, 0-9, /, -, space)
- ⑩-⑵⑲: Message
*Up to 43 ASCII characters (00h-EFh)

• **DV TX data, DV RX data (transceive)**

Command: 22 00, 22 01 01

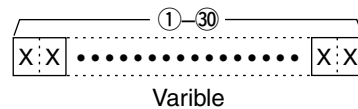

- ①-⑳: Tx, data Rx data (Up to 30 Byte)
**“FA” to “FF” are entered after converted to “FF 0A” to “FF 0F” automatically. Up to 60 Byte data can be entered in this case.

• **MY position data**

Command: 23 00

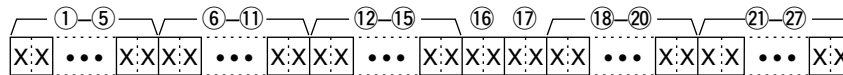

- ①-⑵: Latitude (dd°mm.mmm format)
- ⑶-⑸: Longitude (ddd°mm.mmm format)
- ⑹-⑻: Altitude (0.1 meter steps)
- ⑿, ⑿: Course (1 degree steps)
- ⑳-㉑: Speed (0.1 km/h steps)
- ㉒-㉔: Date (UTC: yyymmddHHMMSS)
*y: Year, m: Month, d: Day, H: Hour, M: Minute, S: Second

• **Manually input position data**

Command: 23 02

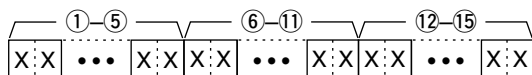

- ①-⑵: Latitude (dd°mm.mmm format)
- ⑶-⑸: Longitude (ddd°mm.mmm format)
- ⑹-⑻: Altitude (0.1 meter steps)

Touch screen calibration function

When no action occurs, or a different function is activated even if you touch the screen correctly, the point and the detected range may be different. In this case, the Touch screen calibration function helps you to correct the touch screen performance.

- ① Touch [MENU].
- ② Touch "Touch Screen Calibration."
(Others > **Touch Screen Calibration**)
 - If the item is not displayed, touch [▲] or [▼] one or more times to select another page.
- ③ Touch the displayed dot on the screen with a thin pen being careful to not damage the screen.
 - When touched, the dot appears on another place.

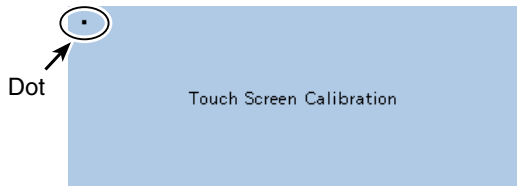

- ④ Repeat step ②.
 - When the calibration is completed, the transceiver returns to the previous screen.

Section 14 OPTIONS

Options14-2

Options

HM-154
HAND MICROPHONE



HM-207
REMOTE-CONTROL
MICROPHONE



SP-30
EXTERNAL SPEAKER
Cable length: 2.8 m (9.1 ft)



SP-35/SP-35L
EXTERNAL SPEAKER
For mobile operation
Cable length
SP-35 : 2 m (6.5 ft)
SP-35L : 6 m (19.7 ft)



MBA-2
CONTROLLER BRACKET



MBF-1
MOUNTING BASE
(for installing the MBA-2)



UT-133
Bluetooth® UNIT

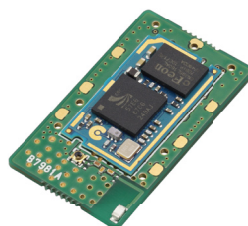

VS-3
Bluetooth® HEADSET



- **OPC-589** MIC ADAPTOR CABLE
Allows you to connect an 8-pin plug microphone.
- **OPC-837** CONTROLLER CABLE
Cable length: 3.5 m (11.4 ft)
- **OPC-440** MIC EXTENSION CABLE
Cable length: 5.0 m (16.4 ft)
- **OPC-647** MIC EXTENSION CABLE
Cable length: 2.5 m (8.2 ft)
- **CS-5100** CLONING SOFTWARE
Free download software (contained in the CD)
- **RS-MS1A** Android® APPLICATION
Free download software
- **OPC-1529R** DATA COMMUNICATION CABLE
RS-232C type
Allows low-speed data communication in the DV mode and data cloning operation with the CS-5100.
- **OPC-2218LU*** DATA COMMUNICATION CABLE
USB type
Allows low-speed data communication in the DV mode and data cloning operation with the CS-5100.
- **OPC-478UC*** CLONING CABLE
USB type
Allows data cloning operation with the CS-5100.

*The OPC-478UC and OPC-2218LU cannot be used with the Windows® 8.1. (As of March 2014)

- **OPC-1156** CONTROLLER EXTENSION CABLE
Cable length: 3.5 m (11.4 ft)
- **CT-17** CI-V LEVEL CONVERTER UNIT
For remote transceiver control using a personal computer equipped with an RS-232C port. You can change frequencies, operating mode, memory channels, and so on with your computer.

Approved Icom optional equipment is designed for optimal performance when used with an Icom transceiver.

Icom is not responsible for the destruction or damage to an Icom transceiver in the event the Icom transceiver is used with equipment that is not manufactured or approved by Icom.

Section 15 Bluetooth® OPERATION

Bluetooth® operations.....	15-2
Precautions	15-3
Electromagnetic Interference	15-4
FCC information	15-4
UT-133 installation	15-5
Connecting to a Bluetooth® headset	15-6
VOX function	15-8
◇ Using the VOX function	15-8
◇ Setting the VOX level.....	15-8
◇ VOX-related settings	15-9
Other settings of the headset	15-10
◇ AF Output.....	15-10
◇ About the Icom headset (VS-3).....	15-10
Downloading the RS-MA1A from the Google Play store ...	15-11
◇ Required items	15-11
◇ Download procedures	15-11
Connecting to a Bluetooth® device.....	15-12
◇ Pairing with the data device.....	15-12
◇ Connection	15-14
Disconnecting from a Bluetooth® device	15-15
Deleting a Bluetooth® device from the pairing list	15-16
Initializing the installed Bluetooth® unit.....	15-17
The maximum number of paired devices	15-18

Bluetooth® operations

When you install the optional UT-133 Bluetooth® UNIT in the transceiver, you can connect to other Bluetooth® devices.

In this section, the ID-5100A/E with the UT-133 is described as simply “transceiver.”

You can connect other devices to the transceiver.

• Icom Headset

When you connect the VS-3 Bluetooth® HEADSET to the transceiver, you can wirelessly transmit and receive the microphone audio.

The VS-3 has a [PTT] switch, so you can transmit in the same way as using the transceiver’s [PTT] switch.

The VOX function can also be used, so you can toggle transmit and receive by your voice through the headset.

You can assign a desired key function to the keys on the side panel of the VS-3 to remotely operate the transceiver.

• Third party Headset

When you connect a third party’s Bluetooth® headset to the transceiver, you can wirelessly transmit and receive the microphone audio.

• Android® device

When you connect a third party’s Android® device to the transceiver, you can use the extended D-STAR® functions with the RS-MS1A (freeware Android® application).

Communication range of Bluetooth® is approximately 10 meters (32.8 feet).

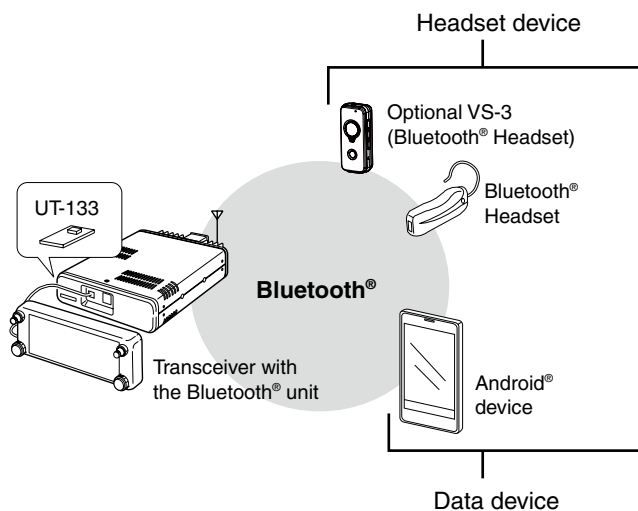

Precautions

⚠ **DANGER HIGH VOLTAGE! NEVER** touch an antenna connector during transmission. This may result in an electrical shock or burn.

⚠ **WARNING RF EXPOSURE!** This transceiver emits Radio Frequency (RF) energy. Extreme caution should be observed when operating this transceiver. If you have any questions regarding RF exposure and safety standards please refer to the Federal Communications Commission Office of Engineering and Technology's report on Evaluating Compliance with FCC Guidelines for Human Radio Frequency Electromagnetic Fields (OET Bulletin 65).

⚠ **WARNING! NEVER** make any changes or modifications to the device.

⚠ **WARNING! NEVER** operate or touch the transceiver with wet hands. This may result in an electric shock or may damage the transceiver.

⚠ **WARNING! NEVER** let metal, wire or other objects touch any internal part or connectors on the rear panel of the transceiver. This may result in an electric shock or this could cause a fire or damage the transceiver.

Place the transceiver in a secure place to avoid inadvertent use by children.

⚠ **WARNING!** Immediately turn the transceiver power OFF and remove the power cable if it emits an abnormal odor, sound or smoke. Contact your Icom dealer or distributor for advice.

DO NOT place the transceiver against walls or putting anything on top of the transceiver. This will obstruct heat dissipation.

DO NOT place the transceiver in excessively dusty environments or in direct sunlight.

DO NOT operate the transceiver near unshielded electrical blasting caps or in an explosive atmosphere.

DO NOT use harsh solvents such as benzine or alcohol to clean the transceiver, as they will damage the transceiver's surfaces. If the transceiver becomes dusty or dirty, wipe it clean with a soft, dry cloth.

DO NOT drop, impact or vibrate this device. This may damage to the unit.

The Bluetooth® communication range may vary, depending on the environment in which the device operates.

Microwave ovens or Wireless LAN may cause an interference.

In that case, stop using those devices or move away from them

This Bluetooth® device has a range of use. If the communication is unstable, use the device within the range.

Electromagnetic Interference

When you use a Bluetooth® device, pay attention to the following:

Bluetooth® devices operate on the 2.4 GHz band.

The 2.4 GHz band is also used by other devices, such as Wireless LAN products, microwave ovens, RFID systems, amateur radio stations, and so on.

When using the this device near such devices, interference may occur, causing a decrease in communication speed, and an unstable connection.

In such cases, use this device away from the other devices, or stop using those devices.

FCC information

• FOR CLASS B UNINTENTIONAL RADIATORS:

This equipment has been tested and found to comply with the limits for a Class B digital device, pursuant to part 15 of the FCC Rules. These limits are designed to provide reasonable protection against harmful interference in a residential installation. This equipment generates, uses and can radiate radio frequency energy and, if not installed and used in accordance with the instructions, may cause harmful interference to radio communications. However, there is no guarantee that interference will not occur in a particular installation. If this equipment does cause harmful interference to radio or television reception, which can be determined by turning the equipment off and on, the user is encouraged to try to correct the interference by one or more of the following measures:

- Reorient or relocate the receiving antenna.
- Increase the separation between the equipment and receiver.
- Connect the equipment into an outlet on a circuit different from that to which the receiver is connected.
- Consult the dealer or an experienced radio/TV technician for help.

CAUTION: Changes or modifications to this device, not expressly approved by Icom Inc., could void your authority to operate this device under FCC regulations.

This device complies with Part 15 of FCC and Industry Canada licence-exempt RSS standard(s). Operation is subject to the following two conditions: (1) this device may not cause interference, and (2) this device must accept any interference, including interference that may cause undesired operation of the device.

Le présent appareil est conforme aux la partie 15 des règles de la FCC et CNR d'Industrie Canada applicables aux appareils radio exempts de licence. L'exploitation est autorisée aux deux conditions suivantes : (1) l'appareil ne doit pas produire de brouillage, et (2) l'utilisateur de l'appareil doit accepter tout brouillage radioélectrique subi, même si le brouillage est susceptible d'en compromettre le fonctionnement.

UT-133 installation

When you install the optional UT-133 Bluetooth® UNIT in the transceiver, you can communicate with other Bluetooth® device.

NOTE:

Before touching the transceiver or UT-133, remove static electricity from your body by touching a grounded object such as a grounded piece of equipment. The static electricity from your body may damage the transceiver or unit, or lose data.

- ① Turn the transceiver upside-down.
- ② Remove the four screws from the bottom of the transceiver and the four screws from the sides, then lift off the bottom cover.

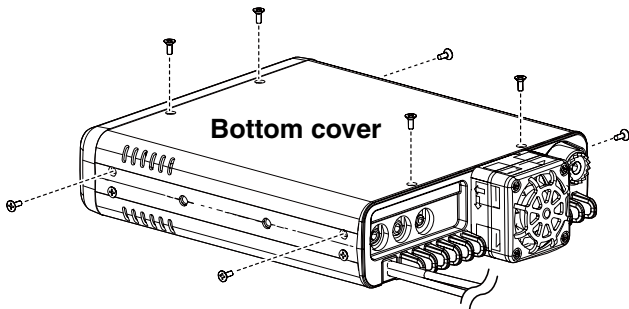

- ③ Remove the screw and clasp, as shown below.

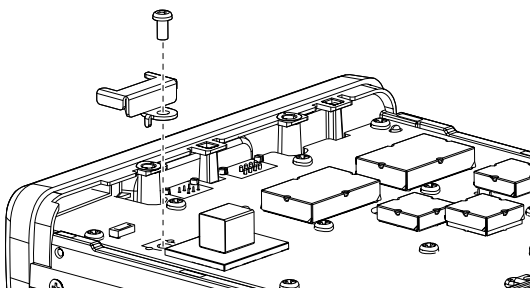

- ④ Place one end the UT-133 under the edge of the front panel, with the connector facing down.

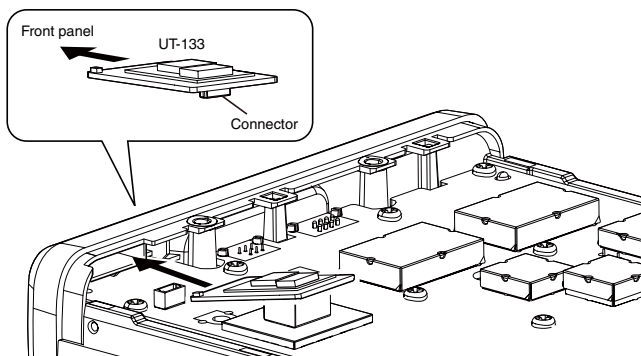

- ⑤ Carefully, push the connector into the socket.
 - Ensure the UT-133 is installed correctly.

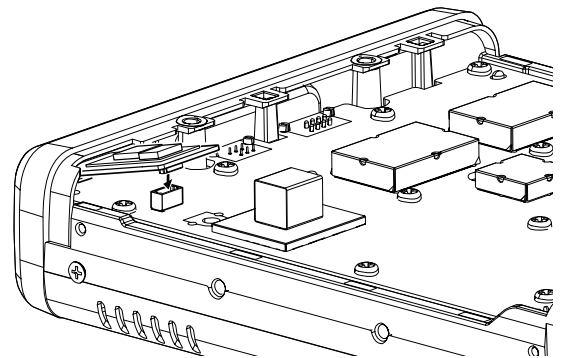

- ⑥ Secure the UT-133 using the screw and clasp that you removed in step ③.

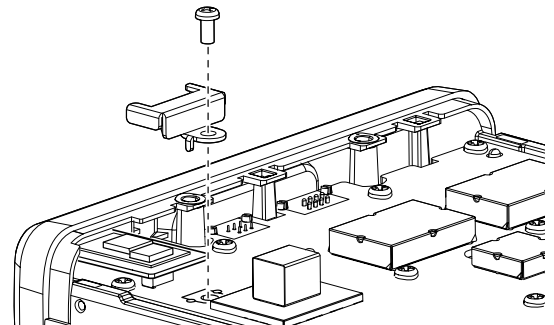

- ⑦ Reattach the bottom cover and screws to their original positions.

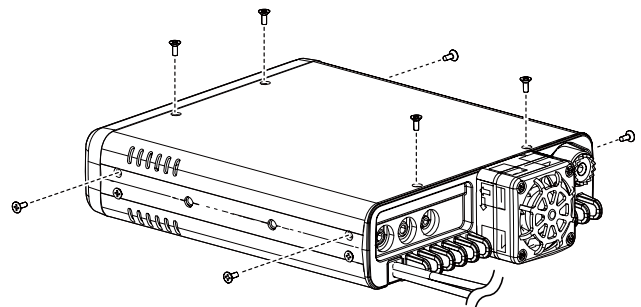

Connecting to a Bluetooth® headset

You can connect the optional or third party's Bluetooth® headset to the transceiver.

The Bluetooth® communication range may vary, depending on the environment in which the device operates. Microwave ovens or Wireless LAN may cause an interference. In that case, stop using those devices or increase the space between the Bluetooth® device and the other devices. This Bluetooth® device has a range of use. If the communication is unstable, use the device within the range.

1. Selecting the pairing mode on the headset.

See the instruction manual of the headset to select the pairing mode.

2. Searching for the headset (Transceiver)

- ① Hold down [⏻] to turn ON the power.
 - ② Touch [MENU].
 - ③ Touch "Bluetooth."
(Bluetooth Set > **Bluetooth**)
- If the item is not displayed, touch [▲] or [▼] one or more times to select another page.

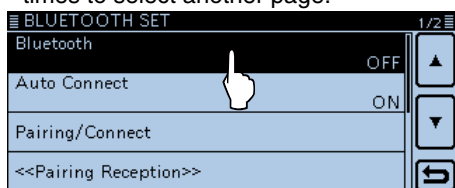

- ④ Touch "ON."



- ⑤ Touch "Pairing/Connect."

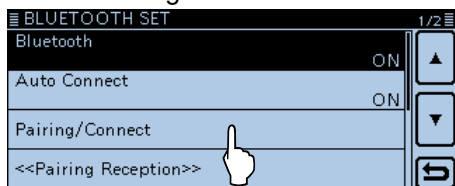

- ⑥ Touch "Device Search."



- ⑦ Touch "Search Headset."
• Displays the available headsets in the pairing list.
(Example: ICOM BT-002)

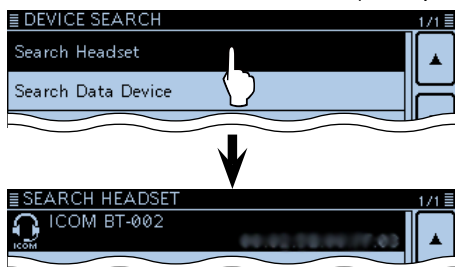

3. Connecting to the headset

- ⑧ Touch "ICOM BT-002."



- ⑨ Touch [YES].
• Connects to the headset.

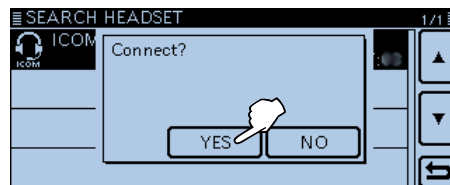

- After the connecting to the headset, "(Connect)" is displayed in the pairing list.



Device name
Bluetooth® address
Appears while connecting
Headset icon ("ICOM" indicate the Icom headset.)

- While connected to a Bluetooth® device, the Bluetooth® icon appears.

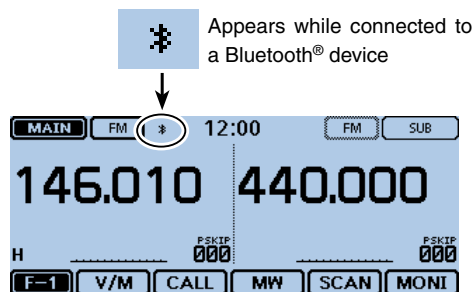

NOTE:
When you pair with the third party's headset, entering a PIN code or pass key may be required. See the instruction manual of the headset for details on entering the PIN code or pass key.

Connecting to a Bluetooth® headset (Continued)

For your reference:
 When you turn ON the transceiver, with the “Auto Connect” item is set to ON, the transceiver automatically connects to the last paired device.

The screenshot shows the radio's main interface. At the top, there are buttons for 'MAIN', 'FM', and 'SUB'. The time '12:00' is displayed. The frequency '146.010000' is shown in large digits. A central message box reads 'ICOM BT-002 Connected.'. Below the frequency, there are 'PSKIP 000' indicators. At the bottom, there are buttons for 'F-1', 'V/M', 'CALL', 'MW', 'SCAN', and 'MONI'.

After connecting to the Bluetooth® device, the dialog box opens, as show above.

For your reference:
 When the transceiver cannot find any available headset, and “No Device Found” is displayed on the screen, touch [QUICK], and then touch “Re-search” to search again for a headset.

The screenshot shows a 'SEARCH HEADSET' menu. The title bar includes a list icon, 'SEARCH HEADSET', and '1/1'. The main content area displays '-- No Device Found --'. On the right side, there are three navigation buttons: an up arrow, a down arrow, and a back arrow.

After touching [QUICK], the following Quick menu window opens.

The screenshot shows a 'SEARCH' Quick menu. The title bar includes a list icon, 'SEARCH', and '1/1'. The main content area displays 'Re-search'. On the right side, there are three navigation buttons: an up arrow, a down arrow, and a back arrow.

VOX function

The VOX (Voice-Operated Transmission) function toggles the transceiver between transmit and receive by your voice. This function provides hands-free operation.

You can use the VOX function with the optional VS-3 or a third party's Bluetooth® headset.

Depending on the headset, the VOX function may be disabled because of the differences in microphones.

Using the VOX function

- ① Touch [MENU].
- ② Touch "VOX."
(Bluetooth Set > Headset Set > VOX > **VOX**)
 - If the item is not displayed, touch [▲] or [▼] one or more times to select another page.

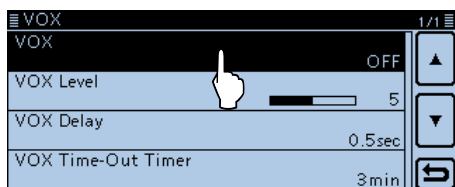

- ③ Touch "ON."



- ④ Touch [MENU].
 - Closes the Menu screen.
 - "VOX" appears.

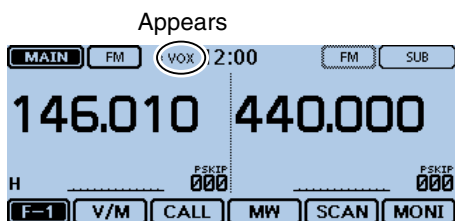

NOTE:
During receiving a signal or sounding a beep, the transceiver does not switch to transmit by your voice.

If the transceiver does not connect to a Bluetooth® headset, you cannot use the VOX function, even if the "VOX" item is set to ON.

Be sure to check the Bluetooth® connection between the transceiver and the headset before using the VOX function.

Setting the VOX level

- ① Touch [MENU].
- ② Touch "VOX Level."
(Bluetooth Set > Headset Set > VOX > **VOX Level**)
 - If the item is not displayed, touch [▲] or [▼] one or more times to select another page.

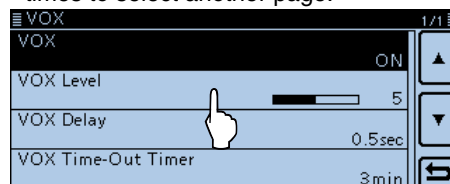

- ③ While speaking into the headset microphone, touch [+] or [-] to adjust the VOX level.
 - The VOX level can be adjusted between 1 (minimum) and 10 (maximum), or turned OFF. (Default: 5)
 - Higher values make the VOX function more sensitive to your voice.
 - "VOX" appears above [+] when the TX level audio is input.

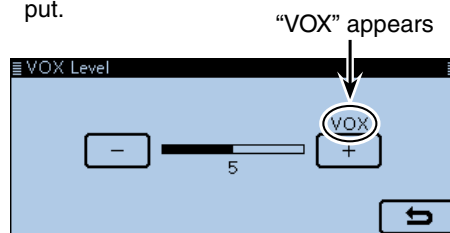

- ④ Touch [MENU].
 - Closes the Menu screen.

- If the S-meter does not display the output power level, and the transceiver does not transmit, set the VOX delay time in the Menu screen. (p. 12-64) (Bluetooth Set > Headset Set > VOX > **VOX Delay**)
- When the VOX function is ON, you can adjust the VOX level by pushing [+] or [-] on the VS-3 while transmitting.
- When the VOX function is ON, you can adjust the VOX level by rotating [DIAL] while transmitting.

NOTE:
We recommend you set the microphone gain in the Menu screen or the headset, before setting the VOX level.
(Function > **MIC Gain**)

VOX function (Continued)

◇ **VOX-related settings**

You can set the “VOX Delay” and “VOX Time-Out Timer” in the Menu screen.

(Bluetooth Set > Headset Set > VOX > **VOX Delay**)

(Bluetooth Set > Headset Set > VOX >

VOX Time-Out Timer)

• **VOX Delay** (p. 12-64)

The VOX delay is the amount of time the transmitter stays ON after you stop speaking. It allows for normal pauses in speaking.

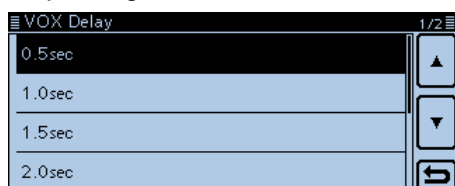

• **VOX Time-Out Timer** (p. 12-64)

The VOX Time-Out Timer prevents accidental prolonged transmission.

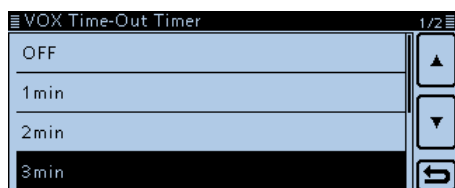

Other settings of the headset

◇ AF Output

Select the AF Output device

If “AF Output” is set to “Headset & Speaker,” you can hear audio from both a connected Bluetooth® headset and the transceiver’s speaker.

- ① Touch [MENU].
- ② Touch “AF Output.”
(Bluetooth Set > Headset Set > **AF Output**)
 - If the item is not displayed, touch [▲] or [▼] one or more times to select another page.

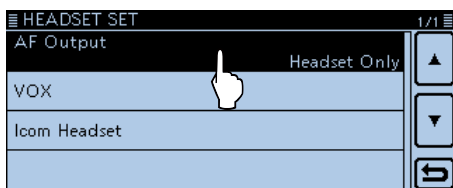

- ③ Touch “Headset & Speaker.”

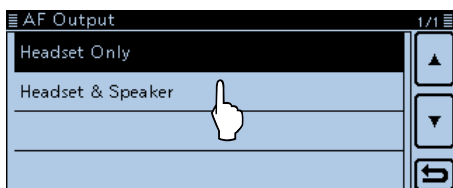

- ④ Touch [MENU].
 - Closes the Menu screen.
 - Audio is heard from both the connected Bluetooth® headset and the transceiver’s speaker.

◇ About the Icom headset (VS-3)

You can set the detailed settings of the optional VS-3 Bluetooth® HEADSET.

Also, you can assign the desired key function to [PLAY], [FWD] and [RWD] in the VS-3’s “Custom Key” screen.

- **“Power Save” screen** (p. 12-65)
The Power Save function temporarily disconnects the Bluetooth® connection if no communication or operation is performed for 120 seconds.

▨ The Power Save function is disabled when the VOX function is ON.

- **“One-Touch PTT” screen** (p. 12-65)
The One-Touch PTT function enables you to toggle transmission and reception by pushing [PTT].

- **“PTT Beep” screen** (p. 12-65)
Set the beep to sound when you push [PTT] on the VS-3.

- **“Custom Key Beep” screen** (p. 12-65)
Set the beep to sound when you push [PLAY], [FWD] or [RWD] on the VS-3.

- **“Custom key” screen** (p. 12-65)
You can assign the desired key function to [PLAY], [FWD] and [RWD] on the VS-3.

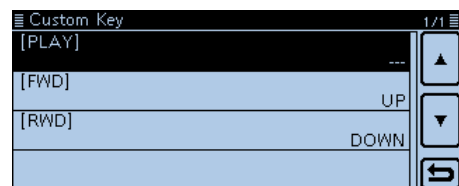
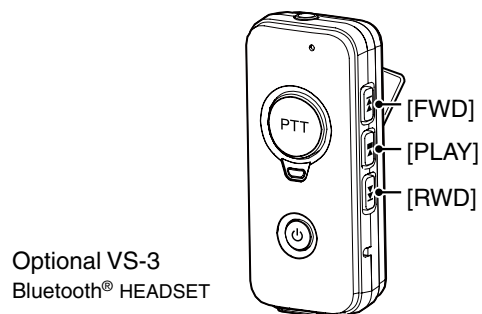

Downloading the RS-MS1A from the Google Play store

The RS-MS1A is a freeware application for Android® devices.

With the RS-MS1A, you can use the extended D-STAR® functions to exchange image files or text messages, or display the received D-PRS station data on a map application.

To use the RS-MS1A, download it from the Google Play store installed in your Android® device.

◇ Required items

- Android® device

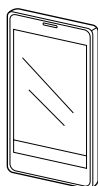

You can use the RS-MS1A with devices that have Android® 4.0 or later installed, and that is compatible with Bluetooth®.

We have checked the RS-MS1A performance with the following smartphone or tablet.

- GALAXY S4 SC-04E
- Nexus 7 (2012)
- Nexus 7 (2013)

Some function may not work correctly, depending on the installed application or memory capability, even if you use one of the above products.

See the instruction manual for details of the operation or account setting of the Android® device.

The screen shot in this manual may differ, depending on your device's OS or its version.

◇ Download procedures

- ① Turn ON your Android® device.
- ② Tap "Play Store."
- ③ Tap "🔍."
- ④ Enter "RS-MS1A" in the "Search Google Play" field.
 - Displays "RS-MS1A" in the application list.
- ⑤ Tap "RS-MS1A."
 - Displays the introduction screen of the RS-MS1A.
- ⑥ Tap [INSTALL].
- ⑦ Tap [ACCEPT] in the "App permissions" window.
 - Installation starts.
 - After finishing the installation, the RS-MS1A icon is displayed on the screen.



← RS-MS1A icon

Connecting to a Bluetooth® device

Before connecting to the Bluetooth® device, you must pair with it.

- **How to pair** (see below)
- **How to connect** (p. 15-14)

The Bluetooth® communication range may vary depending on the environment in which the device operates. Microwave ovens or Wireless LAN may cause interference.

In that case, stop using those devices or leave more space between the Bluetooth® device and the other devices.

This Bluetooth® device has a range of use. If the communication is unstable, use the device within the range.

◇ Pairing with the data device

This section describes how to pair with an Android® device.

1. Preparing the Android® device

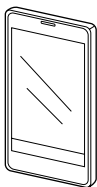

2. Turning ON the Bluetooth® (Transceiver)

- ① Touch [MENU].
- ② Touch "Bluetooth."
(Bluetooth Set > **Bluetooth**)
 - If the item is not displayed, touch [▲] or [▼] one or more times to select another page.

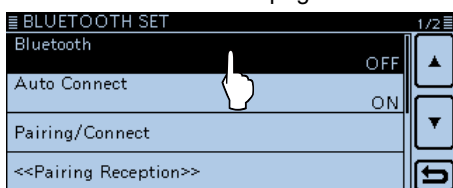

- ③ Touch "ON."



3. Entering the pairing reception mode (Transceiver)

- ④ Touch "<<Pairing Reception>>."

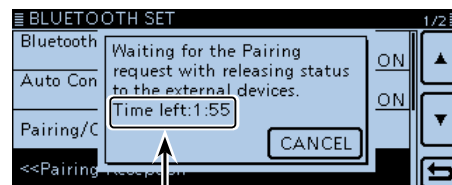
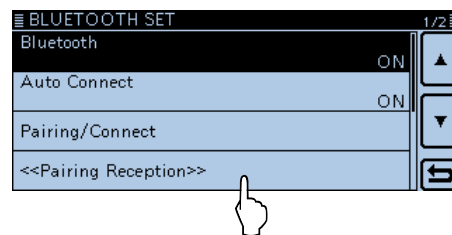

Turn ON Bluetooth® with your Android® device within the displayed time period.

When the time runs out, the transceiver exits the Pairing reception mode.

4. Turning ON the Bluetooth® (Android® device)

- ⑤ Turn ON Bluetooth® with your Android® device.
 - See the instruction manual of the Android® device for details.
 - The Android® device displays the UT-133 Bluetooth® unit name on the screen.
 - You can confirm the UT-133's name on the "BLUETOOTH DEVICE INFORMATION" screen. (p. 12-66)
(Default: ICOM BT-001)

☞ Continued on the next page.

Connecting to a Bluetooth® device

◇ Pairing with the data device (Continued)

5. Sending a pairing request to the transceiver (Android® device)

- ⑥ Touch the displayed UT-133's name to send a pairing request.
 - The Android® device starts to send a pairing request.
 - Opens the “Connection request received from ICOM BT-001. Confirm the following passkey is shown. Passkey: * * * *” dialog box on the transceiver.

NOTE:
Depending on the Android® device, you may not be able to pair with the Bluetooth® device.

6. Receiving a pairing request (Transceiver)

- ⑦ When the transceiver receives a pairing request, confirm the displayed passkey is the same as yours, and then, touch [CONFIRM].
 - Pairing starts.

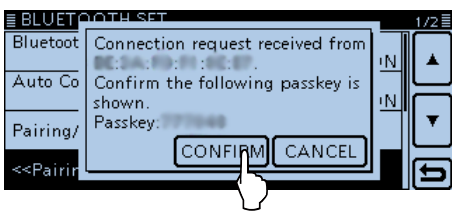

- ⑧ Touch “Pairing/Connect.”
 - After the pairing is complete, the Android® device name is displayed on the pairing list.

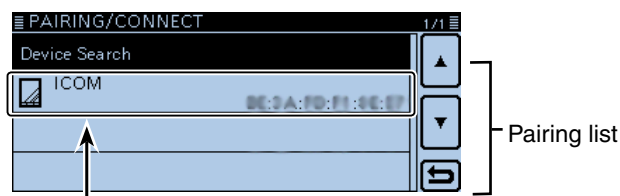
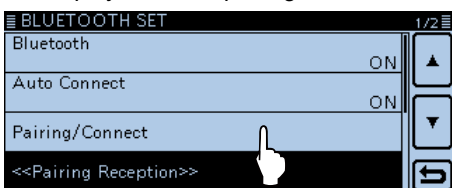

After the pairing is complete, the Android® device name is displayed

NOTE:
When you pair with the third party's headset, entering a PIN code or passkey may be required. See the instruction manual of the headset for details to enter a PIN code or passkey.

Connecting to a Bluetooth® device (Continued)

◇ Connection

This section describes how to connect to the transceiver from an Android® device.

1. Preparing for the connection (Transceiver)

Set “CI-V Transceive” to ON in the Menu screen to control the transceiver and the RS-MS1A with CI-V commands.

(Function > CI-V > **CI-V Transceive**)

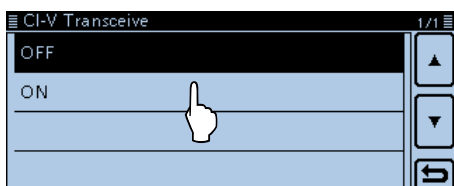

2. Starting the RS-MS1A (Android® device)

Tap the RS-MS1A to start.

See page 15-11 for details on downloading the RS-MS1A.



← RS-MS1A icon

3. Connecting to the transceiver (Android® device)

Tap the UT-133 Bluetooth® unit name displayed on the RS-MS1A.

- Connection starts.
- When your call sign has not been entered in the transceiver, you should enter in before you connect.
- After the connection has succeeded, the “Connect to the * * *” dialog box opens, and “(Connect)” appears under the Android® device name on the transceiver.

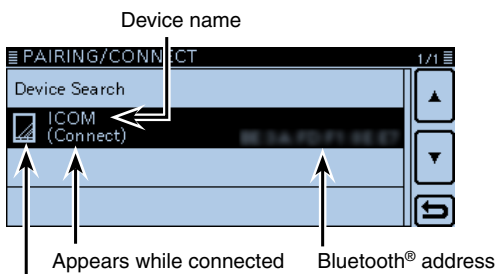

Data device icon

- While connected, the Bluetooth® icon appears.

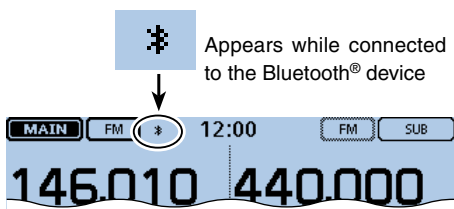

Appears while connected to the Bluetooth® device

To connect to the Android® device from the transceiver:

When the RS-MS1A is started on the Android® device, you can connect to the device from the transceiver.

- ① Touch [MENU].
- ② Touch “Pairing/Connect.”
(Bluetooth Set > **Pairing/Connect**)
 - If the item is not displayed, touch [▲] or [▼] one or more times to select another page.
- ③ Touch the Android® device name displayed in the pairing list.
- ④ Touch [YES].
 - The “* * * Connecting...” dialog box opens. (“* * *” is the Bluetooth® name of the Android® device.)
 - After the connection has succeeded, “(Connect)” appears.



NOTE:

If you cannot connect, check that the same CI-V address is set between the transceiver and the RS-MS1A.

You can see the CI-V setting as described below:

Transceiver:

“CI-V Address” in the Menu screen.
(Function > CI-V > **CI-V Address**) (Default: 8C)

RS-MS1A:

“Application Setting” → “CI-V setting” (Default: 8C)

Disconnecting from a Bluetooth® device

You can disconnect from a Bluetooth® device without cancelling the pairing.

- ① Touch [MENU].
- ② Touch “Pairing/Connect.”
(Bluetooth Set > **Pairing/Connect**)
 - If the item is not displayed, touch [▲] or [▼] one or more times to select another page.
- ③ Touch the Bluetooth® device.

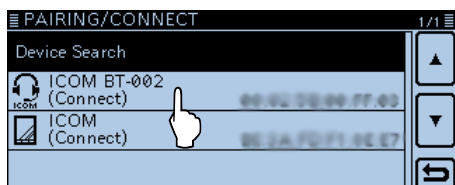

- ④ Touch [YES].

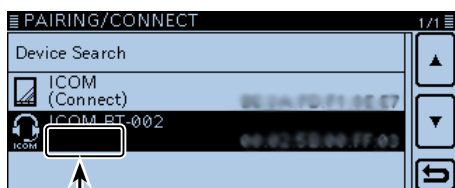
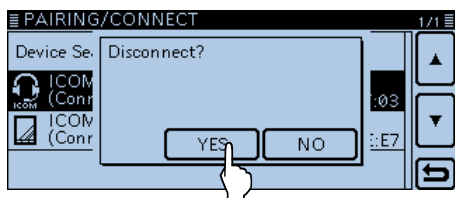

“(Connect)” disappears

- The transceiver disconnects from the Bluetooth® device, and “(Connect)” disappears from the list. However, the transceiver is still paired with the Bluetooth® device.
- When you touch the unconnected Bluetooth® device displayed in the pairing list, the “Connect?” dialog box opens. To connect to the device, touch [YES].

Deleting a Bluetooth® device from the pairing list

You can delete a Bluetooth® device from the pairing list.

Before deleting a connected Bluetooth® device, disconnect it.

- ① Touch [MENU].
- ② Touch "Pairing/Connect."
(Bluetooth Set > **Pairing/Connect**)
 - If the item is not displayed, touch [▲] or [▼] one or more times to select another page.
- ③ Rotate [DIAL] to select the Bluetooth® device to delete.

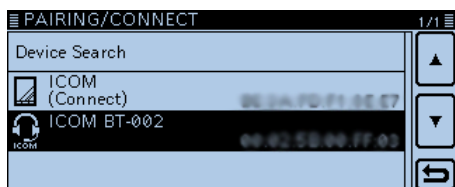

- ④ Touch [QUICK].
- ⑤ Touch "Delete."

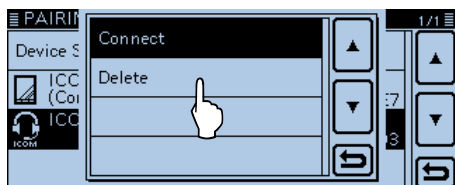

- ⑥ Touch [YES].

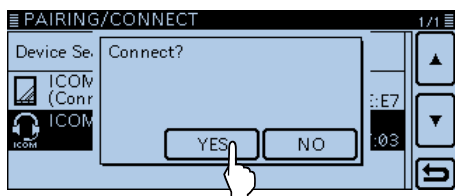

- Deletes the selected device from the pairing list.

▨ If you want to connect the deleted device again, you must first pair with it again.
 Bluetooth® connection (Headset): p. 15-6
 Bluetooth® connection (Data device): p. 15-2

Initializing the installed Bluetooth® unit

You can initialize the installed UT-133 Bluetooth® UNIT. You should initialize the unit if you have trouble during Bluetooth® operation.

When you do a partial reset or all reset, the Bluetooth® settings returns to their factory defaults. However, the device name and pairing/connection information remain.

- ① Touch [MENU].
- ② Touch "Initialize Bluetooth Device."
(Bluetooth Set > **Initialize Bluetooth Device**)
 - If the item is not displayed, touch [▲] or [▼] one or more times to select another page.

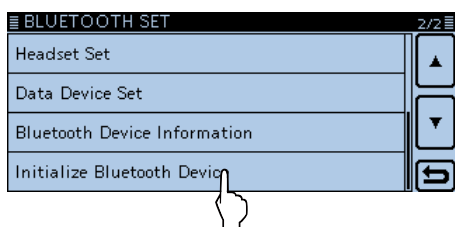

- ③ Touch [YES].

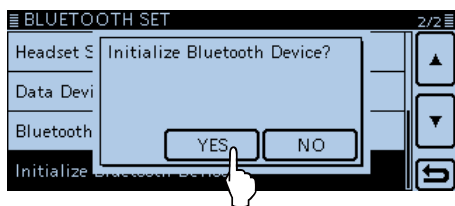

- Closes the Menu screen.
- Resets the installed UT-133 Bluetooth® UNIT's settings to their factory defaults, and returns to the standby display.

The maximum number of paired devices

You can pair two types of the Bluetooth® devices: Headset and Data device.

Up to eight Bluetooth® devices can be paired with the UT-133 Bluetooth® UNIT. However, you cannot pair with eight headsets only, or eight data devices only.

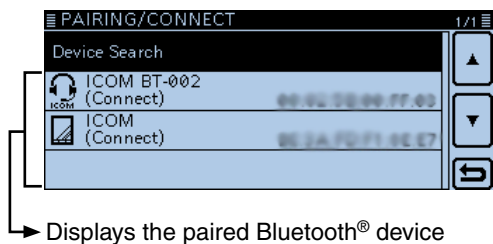

Section 16 SPECIFICATIONS

Specifications	16-2
◇ General.....	16-2
◇ Transmitter.....	16-3
◇ Receiver	16-3

Specifications

◇ General

- Frequency coverage:

EUR	RX	118–174 MHz ^{*1} , 375–550 MHz ^{*2}
	TX	144–146 MHz, 430–440 MHz
ITR	RX	118–136.99166 MHz ^{*3} , 144–146 MHz, 430–434 MHz, 435–438 MHz
	TX	144–146 MHz, 430–434 MHz, 435–438 MHz
TPE	RX	144–146 MHz, 430–432 MHz
	TX	144–146 MHz, 430–432 MHz
USA	RX	118–174 MHz ^{*4} , 375–550 MHz ^{*5}
	TX	144–148 MHz, 430–450 MHz ^{*5}
KOR	RX	144–146 MHz, 430–440 MHz
	TX	144–146 MHz, 430–440 MHz
EXP	RX	118–174 MHz ^{*4} , 375–550 MHz ^{*2}
	TX	137–174 MHz ^{*4} , 400–470 MHz ^{*2}

^{*1} Guaranteed only 144–146 MHz, ^{*2} Guaranteed only 430–440 MHz, ^{*3} Not guaranteed, ^{*4} Guaranteed only 144–148 MHz, ^{*5} Guaranteed only 440–450 MHz

- Mode: F2D/F3E (FM/FM-N), F7W (DV), A3E (AM/AM-N) RX only
- No. of memory channels: 1000 channels
- No. of program scan channels: 25 channels (2 edge frequencies in each channel)
- No. of call channels: 4 channels (2 channels × 2 bands)
- Antenna connector: SO-239
- Antenna impedance: 50 Ω
- Usable temperature range: –10°C to +60°C; +14°F to +140°F
- Frequency stability: ±2.5 ppm (–10°C to +60°C; +14°F to +140°F)
- Digital transmission speed: 4.8 kbps
- Voice coding speed: 2.4 kbps
- Frequency resolution: 5 kHz, 6.25 kHz, 8.33 kHz, 10 kHz, 12.5 kHz, 15 kHz, 20 kHz, 25 kHz, 30 kHz, 50 kHz
The 8.33 kHz step is not selectable, depending on the operating band or mode.
- Power supply: 13.8 V DC ±15% (negative ground)
- Current drain:
 - Transmit
 - Maximum current drain: ≤ 10.5 A (TPE version)
≤ 13.0 A (Other versions)
 - Receive
 - Standby: ≤ 1.2 A
 - Maximum audio: ≤ 1.8 A
- Dimensions (projections not included):
 - Main unit: 150(W) × 40(H) × 172.6(D) mm; 5.9(W) × 1.6(H) × 6.8(D) inch
 - Controller: 182.2(W) × 24.8(H) × 81.5(D) mm; 7.2(W) × 1.0(H) × 3.2(D) inch
- Weight (approximately):
 - Main unit: 1.3 kg; 2.9 lb
 - Controller: 260 g; 9.2 oz

All stated specifications are typical and subject to change without notice or obligation.

Specifications (Continued)

◇ Transmitter

- Modulation system:

FM/FM-N	Variable reactance frequency modulation
DV	GMSK reactance frequency modulation
- Max Deviation:

FM	$\leq \pm 5.0$ kHz
FM-N	$\leq \pm 2.5$ kHz
- Microphone impedance: 600 Ω
- Spurious emission: ≤ -60 dBc
- Output power: High 25 W, Mid 15 W, Low 5 W (TPE version)
High 50 W, Mid 15 W, Low 5 W (Other versions)

◇ Receiver

- Receive system: Double superheterodyne system
- IF frequencies:

A band	1st IF	38.85 MHz
	2nd IF	450 kHz
B band	1st IF	46.35 MHz
	2nd IF	450 kHz
- Sensitivity (except spurious points)

Amateur bands	
FM/FM-N (12 dB SINAD)	≤ 0.18 μ V
DV (BER 1%)	≤ 0.28 μ V
Except Amateur bands	
FM/FM-N (12 dB SINAD)	
	≤ 0.32 μ V (137.000 to 159.995 MHz)
	≤ 0.56 μ V (160.000 to 174.000 MHz)
	≤ 0.56 μ V (375.000 to 399.995 MHz)
	≤ 0.32 μ V (400.000 to 499.995 MHz)
	≤ 0.56 μ V (500.000 to 550.000 MHz)
AM (10 dB S/N)	≤ 1 μ V (118.000 to 136.99166 MHz)
- Squelch sensitivity: ≤ 0.13 μ V (Threshold)
- Selectivity:

FM	≥ 60 dB
FM-N	≥ 55 dB
DV	≥ 50 dB
- Spurious and image rejection ratio:

	≥ 60 dB
	≥ 55 dB (A band UHF)
- AF output power: ≥ 2.0 W (at 10% distortion with an 8 Ω load)
- AF output impedance: 8 Ω

Section 17 MAINTENANCE

Resetting the CPU	17-2
◇ Partial Reset.....	17-2
◇ All reset	17-3
Troubleshooting.....	17-4
◇ While operating D-STAR	17-4
◇ While operating GPS logger.....	17-5
◇ Transceiver power	17-5
◇ Transmit and receive	17-5
◇ Display.....	17-6
◇ Scanning	17-6

Resetting the CPU

Occasionally, erroneous information will be displayed when, for example, first applying power. This may be caused externally by static electricity or by other factors.

If this problem occurs, turn OFF power.

After waiting a few seconds, turn ON power again. If the problem is still there, perform a Partial reset or an All reset.

◆ Partial Reset

① Touch [MENU].

② Touch "Partial Reset."

(Others > Reset > **Partial Reset**)

- If the item is not displayed, touch [▲] or [▼] one or more times to select the page.

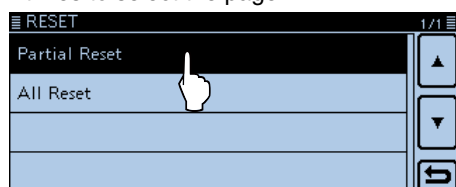

③ Touch [YES].

- The transceiver displays "PARTIAL RESET," then the partial reset is completed.

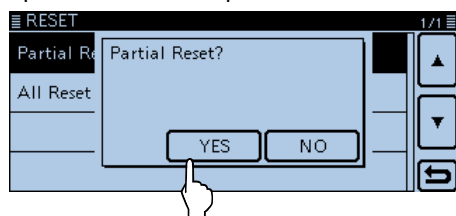

/// A Partial reset resets the operating settings to their default values (VFO frequency, VFO settings, menu contents) without clearing the items below:

- Memory channel contents
- Scan Edge contents
- Call channel contents
- Call sign memories
- Message data
- DTMF memory contents
- GPS Memory contents
- Repeater list

Resetting the CPU (Continued)

◇ All reset

NOTE for the All reset:

After you perform an All reset, you cannot use the DR function because the repeater list will be cleared. So we recommend you save the programmed data onto an SD card, or to your PC using the CS-5100 cloning software (contained in the CD) before performing an All reset. After the All reset is finished, load or write the saved data into your transceiver.

- ① Touch [MENU].
- ② Touch "All Reset."
(Others > Reset > **All Reset**)
 - If the item is not displayed, touch [▲] or [▼] one or more times to select the page.



- ③ Touch "NEXT."

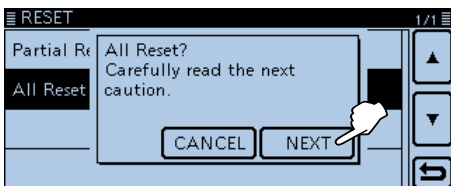

- ④ Touch "YES."

 - After the All reset is finished, the default screen is displayed.

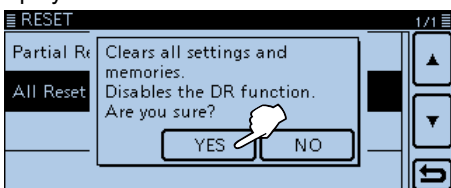

After an All reset

An all reset clears all programming, and returns all settings to their factory defaults. Therefore, the repeater list, Memory channel contents, filter settings and so on will be cleared, so you will need to reenter your memories, list and operating settings.

When you cannot enter the Set mode

If a touch screen error or an unexpected operation occurs, you may not be able to enter the Menu screen. In this case, perform the All reset, as described below:

- While holding down the reset button on the controller back panel, push [ON] to turn power ON.

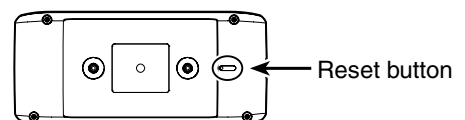

Troubleshooting

The following chart is designed to help you correct problems which are not equipment malfunctions.

If you are unable to locate the cause of a problem, or solve it through the use of this chart, contact your nearest Icom Dealer or Service Center.

◇ While operating D-STAR

PROBLEM	POSSIBLE CAUSE	SOLUTION	REF.
After you transmit, no signal is returned from the repeater. (No S-meter indication)	<ul style="list-style-type: none"> The repeater setting is wrong. Your transmission did not reach the repeater. 	<ul style="list-style-type: none"> Select the correct repeater. Correct the repeater frequency, frequency offset, or duplex setting. Wait until you are closer to the repeater and try it again. Try to access another repeater. 	<p>p. 6-18</p> <p>—</p> <p>—</p> <p>—</p>
After you transmit, the repeater replies 'UR?' and its call sign.	<ul style="list-style-type: none"> The call was successfully sent, but no station immediately replied. 	<ul style="list-style-type: none"> Wait for a while, and try it again. 	<p>—</p>
After you transmit, the repeater replies 'RX' or 'RPT?' and the access repeater's call sign.	<ul style="list-style-type: none"> Your call sign has not been correctly set into your transceiver. Your call sign has not been registered on a trust sever. Your call sign is not recognized at the repeater. 	<ul style="list-style-type: none"> Make sure that your call sign is correctly set into your transceiver. Register your call sign on a trust sever through a D-STAR repeater, or confirm the registration of the call sign. 	<p>p. 6-5</p> <p>p. 6-7</p>
After you transmit, the access repeater replies 'RPT?' and its call sign.	<ul style="list-style-type: none"> The call sign of the destination repeater is wrong. 	<ul style="list-style-type: none"> Correctly set the destination repeater call sign. 	<p>—</p>
After you transmit, the repeater replies 'RPT?' and call sign of the destination repeater.	<ul style="list-style-type: none"> The repeater cannot connect to the destination repeater. The repeater is busy. 	<ul style="list-style-type: none"> Check the repeater setting. Wait for a while, and try it again. 	<p>—</p> <p>—</p>
Even holding down [DR], the DR screen does not appear.	<ul style="list-style-type: none"> There is no repeater list in your transceiver. 	<ul style="list-style-type: none"> Reload the repeater list using the SD card. Enter the Repeater list data directly into the transceiver. 	<p>p. 6-35</p> <p>p. 7-22 to p. 7-24</p>
Even holding down [RX>CS], the received call sign does not set to the destination call sign to make a call back.	<ul style="list-style-type: none"> The transceiver did not correctly receive the call sign data. When a received signal is weak, or a signal is received during scanning, the call sign may not be received correctly. In that case, "-----" appears and error beeps sound, and a reply call cannot be made. 	<ul style="list-style-type: none"> Try it again, after the transceiver has correctly received the call sign. 	<p>—</p>
A Local area call can be made, but the Gateway call or destination station call cannot be made.	<ul style="list-style-type: none"> Your call sign (MY) has not been registered on a D-STAR repeater. 	<ul style="list-style-type: none"> Register your call sign (MY) on a D-STAR repeater, or confirm the registration of the call sign. 	<p>p. 6-7</p>

Troubleshooting

◇ While operating D-STAR (Continued)

PROBLEM	POSSIBLE CAUSE	SOLUTION	REF.
"L" appears on the LCD. 	<ul style="list-style-type: none"> While receiving data through the Internet, some packets may be lost due to a network error. 	<ul style="list-style-type: none"> Wait a while, and try it again. When the transceiver receives corrupted data, and misidentifies it as packet loss, "L" appears, even if it is a Local area call. 	—
"DV" and "FM" icons alternately blink.	<ul style="list-style-type: none"> While in the DV mode, an FM signal is received. 	<ul style="list-style-type: none"> Wait a while, and try it again. 	p. 7-11
The simplex operation cannot be made in the DR screen.	<ul style="list-style-type: none"> Duplex mode (DUP+, DUP-) is set. A repeater frequency is programmed. 	<ul style="list-style-type: none"> Select "OFF" in "DUP" setting of the repeater list. Set a simplex frequency. 	p. 7-23 p. 6-8
The digital code squelch (CSQL) is impossible.	<ul style="list-style-type: none"> The wrong digital code is set. 	<ul style="list-style-type: none"> Set the correct digital code. 	p. 7-17
You don't know how to update the repeater list.	—	<ul style="list-style-type: none"> See "Updating the repeater list" to check. 	p. 6-35

◇ While operating GPS logger

PROBLEM	POSSIBLE CAUSE	SOLUTION	REF.
Position data cannot be received.	<ul style="list-style-type: none"> The "GPS Select" item is set to "OFF" or "Manual" in the Menu screen. A GPS signal was not received. 	<ul style="list-style-type: none"> Select "Internal GPS." Move until the GPS signal is received. 	p. 12-20 —

◇ Transceiver power

PROBLEM	POSSIBLE CAUSE	SOLUTION	REF.
Power does not turn ON when [PWR] is pushed.	<ul style="list-style-type: none"> The power cable is improperly connected. A fuse is blown. Power source voltage is not correct. 	<ul style="list-style-type: none"> Reconnect the DC power cable correctly. Correct the cause, then replace the fuse with an equivalent fuse. (Fuses are installed in the DC power cable and in the internal PA unit.) Apply the correct 13.8 V DC. 	— — —

◇ Transmit and receive

PROBLEM	POSSIBLE CAUSE	SOLUTION	REF.
No sound from the speaker.	<ul style="list-style-type: none"> The audio volume level is too low. The squelch is closed. The tone squelch is ON in the FM mode. The external speaker is not connected. The audio is muted. 	<ul style="list-style-type: none"> Rotate the [VOL] control clockwise to obtain a suitable listening level. Rotate the [SQL] control to 12 o'clock position to open the squelch. Turn OFF the Tone squelch. Correct the cause, then reconnect. Rotate [DIAL], [VOL] or [SQL], or operating a key, touch screen or microphone to release mute. 	p. 2-2 p. 2-2 p. 13-8 — p. 2-2
Sensitivity is too low, and only strong signals can be heard.	<ul style="list-style-type: none"> The antenna is defective or the coaxial cable connector is shorted or cut. The Attenuator function is turned ON. The squelch is set too tight. 	<ul style="list-style-type: none"> Reconnect to the antenna connector. Turn OFF the attenuator. Rotate the [SQL] control to adjust the squelch level. 	— p. 2-13 p. 2-2

Troubleshooting

◇ Transmit and receive (Continued)

PROBLEM	POSSIBLE CAUSE	SOLUTION	REF.
No contact can be made with another station.	<ul style="list-style-type: none"> • Duplex function are ON, and the transmit and receive frequencies are different. 	<ul style="list-style-type: none"> • Turn OFF the Duplex function. 	p. 11-4
The displayed frequency is erroneous.	<ul style="list-style-type: none"> • The CPU has malfunctioned. • External factors have caused the fault. 	<ul style="list-style-type: none"> • Reset the transceiver. • Disconnect and connect to the DC power supply. 	p. 17-2 —
Cannot receive on the SUB band.	<ul style="list-style-type: none"> • The SUB band mute is activated. 	<ul style="list-style-type: none"> • Turn OFF the function. 	p. 12-61

◇ Display

PROBLEM	POSSIBLE CAUSE	SOLUTION	REF.
The displayed frequency does not change.	<ul style="list-style-type: none"> • The Lock function is ON. • The Memory or Call channel is selected. • The DR screen is displayed. 	<ul style="list-style-type: none"> • Turn OFF the function. • Touch [VFO] to select the VFO mode. • Touch [DR] to cancel the DR function. 	p. 2-13 p. 2-9 p. 2-9

◇ Scanning

PROBLEM	POSSIBLE CAUSE	SOLUTION	REF.
A Programmed scan does not start.	<ul style="list-style-type: none"> • The VFO mode is not selected. • The same frequencies are entered into the scan edges. 	<ul style="list-style-type: none"> • Touch [VFO] to select the VFO mode. • Enter different frequencies into the scan edges. 	p. 2-9
A Memory scan does not start.	<ul style="list-style-type: none"> • The Memory mode is not selected. • 2 or more memory channels have not been programmed. 	<ul style="list-style-type: none"> • Touch [V/M] to select the Memory mode. • Program more than 2 memory channels. 	p. 2-9 p. 3-6

INDEX

1
1750 Hz tone burst 11-3

A

Accessing repeaters 6-9
Active band 12-55
AF Output 12-64, 15-10
Alarm
 Alarm Area (Group) 12-35
 Alarm Area (RX/Memory) 12-35
 Alarm Select 12-35
All reset 12-67, 17-3
Altitude (Position) 12-23
Application setting 8-25
Attenuator function 2-13
Auto Connect 12-64
Auto Dimmer 12-57
Auto Dimmer Timer 12-57
Automatic DV detection 7-11
Automatic Reply function 7-12
Auto Position Reply function 7-14
Auto Power OFF 12-62
Auto Repeater 11-6, 12-52
Auto Reply 12-44

B

Backlight 12-57
Band Edge Beep 12-61
Band Scope function 2-14
Bank Link 12-14
Beep Level..... 12-61
BK 7-8, 12-45
Bluetooth 12-64
 Bluetooth Device Information 12-66
 Operations 15-2
 Bluetooth Set items 12-64
 Connection
 To a Bluetooth® device 15-12
 To a Bluetooth® headset 15-6
 Deleting a Bluetooth® device from the
 pairing list 15-16
 Disconnecting from a Bluetooth® device 15-15
 Downloading the RS-MA1A from the Google Play
 store 15-11
 Download procedures 15-11
 Required items 15-11
 Initializing..... 12-66, 15-17
 One-Touch PTT 12-65
 Other settings of the headset 15-10
 The maximum number of paired devices 15-18
Busy Lockout..... 12-55

C

Call CH 12-13
 Selecting a Call channel 2-9, 3-5
Call Sign
 Call Sign items 12-37
 Capturing a call sign 6-12
 Deleting Your (destination) call sign 7-34
 Entering Your (destination) call sign 7-32
 Enter your call sign into the transceiver 6-5
 My Call Sign 12-43
 Rearranging the display order of
 Your (destination) call signs 7-35
 Register your call sign at a gateway repeater ... 6-7
 TX Call Sign 12-58
 Viewing the call signs 7-18
 Viewing the received call signs 7-6
 Your Call Sign 12-41
CI-V
 Address 12-56
 Baud Rate 12-56
 CI-V Bluetooth→REMOTE Transceive Address ... 12-56
 CI-V Transceive 12-56
 Connection example 13-16
 Command table 13-17
 Data format 13-16
 Remote jack (CI-V) information 13-16
Cloning
 Clone Mode..... 12-67
 Cloning function 13-12
 Cloning from a PC
 Using an optional cloning cable 13-15
 Using an SD card 13-15
 Transceiver-to-Transceiver cloning
 Using an SD card 13-12
Comment
 Item 12-27
 Object 12-24
 Position 12-22
 Weather 12-30
Controller
 Display (Touch screen) 1-3
 Front panel 1-2
Course
 Item 12-28
 Object 12-25
Cross-Band repeater operation 13-11
Custom Key 12-65
Custom Key Beep..... 12-65

INDEX

D

- Data Extension
 - Item 12-28
 - Object 12-25
 - Position 12-23
- Data Speed 12-56
- Data Type
 - Item 12-27
 - Object 12-24
- Date 12-49, 12-62, 12-63
- Dial Speed-UP 12-52
- Digital Monitor 12-45
- Digital Repeater Set..... 12-45
- Digital squelch functions 7-16
 - Digital call sign squelch setting 7-16
 - With a Pocket beep 7-16
 - Digital code squelch setting 7-17
 - Digital Code 12-12
 - With a Pocket beep 7-17
- Directivity
 - Item 12-29
 - Object 12-26
 - Position 12-23
- Display items 12-57
- Display Language..... 12-59
- Display type setting 7-10
- Display unit
 - Altitude/Distance 12-58
 - Barometric 12-59
 - Latitude/Longitude 12-58
 - Rainfall 12-59
 - Speed 12-59
 - Temperature 12-59
 - Wind Speed 12-59
- D-PRS 8-15
 - Displayed items 8-6, 8-16
 - Object/Item setting 8-19
 - Position (Mobile/Base) setting 8-17
 - Weather setting 8-23
 - Operating D-PRS 8-15
 - Transmitting D-PRS data 8-15
- DR (D-STAR Repeater) function 6-3
 - Accessing repeaters 6-9
 - Calling an individual station 6-15
 - Capturing a call sign 6-12
 - Communication Form 6-4
 - DR (D-STAR Repeater) function selection..... 2-10
 - DR scan
 - Skip setting 7-29
 - Making a Gateway Repeater call..... 6-14
 - Making a Local area call 6-13
 - Making a Simplex call 6-8
 - “FROM” (Access repeater) setting 6-18
 - Using the Near Repeater Search function ... 6-21
 - Using your transceiver’s repeater list 6-19
 - Using the DR scan 6-20
 - Using the TX History 6-22
 - “TO” (Destination) setting 6-23
 - Directly inputting (RPT) 6-29
 - Directly inputting (UR)..... 6-28
 - Using the “Gateway CQ” (Gateway call) 6-24
 - Using the “Local CQ” (Local Area call) 6-24
 - Using the RX History 6-26
 - Using the TX History 6-27
 - Using “Your Call Sign” 6-25
- D-STAR
 - Intoroduction 6-3
 - Troubleshooting (while operating D-STAR) ... 17-4
 - Unique features 6-2
 - Your setting is correct? 7-36
- DTCS
 - Code..... 12-12
 - Operation..... 13-9
 - Polarity 12-12
 - Setting 13-9
- DTMF
 - DTMF items 12-48
 - DTMF Memory 12-48
 - DTMF Speed 12-48, 13-7
 - Entering DTMF code 13-5
 - Transmitting DTMF code 13-6
 - Transmitting DTMF code (Direct Input) 13-6
 - Using the DTMF memory 13-5
- Dualwatch operation 2-15
- Duplex operation 11-4
 - Setting the duplex direction 11-4
- DUP/TONE items 12-12
- DV Auto Detect 12-45
- DV Auto Reply 12-18
- DV Data TX 12-44
- DV Memory items 12-41
- DV Set items 12-44

INDEX

E

Electromagnetic Interference	15-4
EMR	7-9, 12-45
EMR AF Level	7-9, 12-45
Export.....	9-12, 12-63

F

Fan Control	12-52
FCC information	15-4
File Split	12-18
Format	9-4, 12-63
Frequency	
Frequency range and offset direction	11-6
Frequency setting	1-9
Frequency offset setting	11-4
Function items	12-52

G

Gain	
Item	12-29
Object	12-26
Position	12-23
GPS	
Add a GPS memory	8-29
Changing the Compass Direction	8-11
Changing the GPS memory or alarm	8-10
Checking GPS information (Sky view screen)	8-13
Checking your GPS position	8-4
Clearing GPS data.....	8-34
Displaying Position Data	8-4
Displaying your position using a mapping program	8-26
Entering the GPS group name.....	8-33
Entering the GPS message	8-28
GPS alarm setting	8-36
GPS automatic transmission setting	8-41
GPS Auto transmission for only Simplex	8-41
GPS Auto TX	12-36
GPS data sentence setting	8-27
GPS Information.....	12-32
GPS items	12-20
GPS Logger	12-36
GPS Logger function.....	8-38
GPS Logger operating outline	8-38
GPS Logger operation	8-38
GPS memory	8-29, 12-34
GPS Message	12-32
GPS operation	8-2
GPS Out (To DATA jack)	12-20
GPS Position	12-32
GPS receive setting	8-2
GPS record interval setting	8-38
GPS Select	12-20

GPS (Continued)

GPS Sentence	12-31
GPS Time Correct	12-62
GPS TX Mode.....	12-20
GPS TX mode setting	8-14
Grid Locator	8-11
Manual Position	12-20
Rearranging the display order	8-35
Saving your own or received position data ...	8-12
Setting the display type (MAIN/SUB)	8-10
Transmitting GPS data (D-PRS and NMEA) ...	8-14
Transmitting NMEA data	8-27
Type of position data	8-14
Unproto Address	12-20
Viewing the log data on a PC Map	8-39
When a received signal contains position data ...	8-3
While operating GPS logger.....	17-5

H

Hang Up Time	12-67
Height	
Item	12-29
Object	12-26
Position	12-23
Heterodyne	
A BAND UHF	12-56
A BAND VHF	12-56
B BAND UHF	12-56
Home channel	
Home channel function	2-16
Home CH Beep	12-61
Operation.....	2-16
Setting	2-16

I

Import.....	9-11, 12-63
Item Name	12-27
Item setting (D-PRS)	8-19

K

Keyboard Type	12-55
Key-Touch Beep	12-61

INDEX

L

Language
 Display Language 12-59
 System Language 12-59
LCD Contrast 12-57
Loading 9-8
Load Setting 12-63
Lock function 2-13
Low-speed data communication 7-15
 Application setting 7-15
 Connection 7-15

M

MAIN band selection 2-15
Main unit — Front and rear panels 1-7
Memory channel
 Clearing a Memory channel 3-16
 Copying Memory content to another Memory
 channel 3-9
 Copying Memory content to the VFO 3-8
 Directly entering into a memory bank 3-11
 Entering a Bank name 3-14
 Entering a Memory name 3-13
 Entering the Manage Memory screen 3-3
 General description 3-2
 Manage Memory
 Manage Memory items 12-13
 Manage Memory screen description 3-3
 Tree view of the Manage Memory screen 3-3
Memory bank
 Memory channel assignment 3-10
 Memory bank scan 4-2, 4-9
 Memory bank setting 3-10
Memory CH 12-13
Memory channel content 3-2
Memory channel setting 1-9
Memory mode selection 2-9
Memory scan 4-2, 4-8
Overwriting into the selected channel 3-7
Selecting a Memory channel 3-4
Selecting a Memory name display 3-15
Selecting the Memory bank mode 3-12
Writing into a blank channel 3-6
Writing into the selected channel 3-6

Menu screen

 Entering the Menu screen 12-2
 Menu items and Default settings 12-3
 Bluetooth Set items 12-64
 Call Sign items 12-37
 Display items 12-57
 DTMF items 12-48
 DUP/TONE items 12-12
 DV Memory items 12-41
 DV Set items 12-44
 Function items 12-52
 GPS items 12-20
 Manage Memory items 12-13
 My Station items 12-43
 Others items 12-67
 QSO/RX Log items 12-49
 RX History items 12-38
 Scan items 12-14
 SD Card items 12-63
 Sounds items 12-61
 SPEECH items 12-46
 Time set items 12-62
 Voice Memo items 12-17
 Voice TX items 12-19
 Menu item selection 12-2
Message operation 7-2
 Transmitting 7-4
Microphone
 MIC Gain 2-15, 12-55
 Microphone connector information 1-7
 Microphone (HM-207) 1-8
MODE SPEECH 12-46
Mode selection 2-9
My Call Sign 12-43
My Station items 12-43

N

Name
 Item 12-27
 Object 12-24

O

Object Name 12-24
Object setting (D-PRS) 8-19
Off band indication 11-5
Offset frequency 12-12
One-Touch PTT 12-65
One-Touch PTT (Remote MIC) 12-55
Opening Message 12-58
Options 14-2
Others items 12-67

INDEX

P

Pairing
 Pairing with the data device 15-12
 Pairing/Connect 12-64
 <<Pairing Reception>> 12-64
Partial Reset 12-67, 17-2
Pause Timer 12-14
Play back
 Play Files 12-17
 Playing back the recorded audio 10-3
 Playing back the recorded audio on the PC ... 10-9
Position
 Item 12-28
 Object 12-25
Position (Mobile/Base) setting (D-PRS) 8-17
Power
 Item 12-29
 Object 12-26
 Position 12-23
Power OFF (With No Controller) 12-56
Power Save 12-65
Precautions 15-3
Priority watch 5-2
 A frequency in "FROM" on the DR screen and a
 priority channel 5-12
 DR scan and a priority channel 5-3, 5-16
 VFO frequency and a Memory/Bank scan... 5-2, 5-6
 VFO frequency and a priority channel 5-2, 5-4
 VFO scan and a priority channel 5-2, 5-8
 VFO scan and Memory/Bank scan 5-10
 Setting the frequency in "FROM" on the DR screen,
 and a priority channel 5-3
Program Link 12-15
Program Scan Edge 12-14
Program Skip 12-14
PTT Auto REC 12-18
PTT Beep 12-65
PTT Lock 12-55

Q

QSO Log 12-49
QSO/RX Log items 12-49

R

Receive mode during a scan 4-3
Receiving 2-11
 When a signal is received 4-4
REC Mode 12-17
Recording
 Record (Voice TX) 12-19
 Auto Reply voice announcement 7-13
 QSO audio 10-2
 Record Interval 12-36
 <<REC Start>> 12-17
 Starting to record 10-2
 Stop recording 10-2
 Voice audio 13-2
Reflector
 Linking to a reflector 6-31
 Reflector Echo Testing 6-33
 Requesting repeater information 6-34
 Unlinking a reflector 6-33
 Using a reflector 6-32
 What is the reflector? 6-30
Remote MIC Key 12-52
Removing the SD card 9-5
Repeater
 Checking the repeater input signal 11-3
 FM Repeater operation 11-2
Repeater list 7-20, 12-41
 Contents 7-20
 Deleting a repeater list 7-26
 Editing a repeater list 7-25
 Entering new information into the Repeater List 7-21
 Rearranging the display 7-27
 Repeater detail screen 7-31
 Repeater group name programming 7-30
 Required items for the communication cases ... 7-21
 Updating 6-35
Repeater mode operation (USA version only) ... 13-11
 Entering 13-11
 Exiting 13-11
 <<Repeater Mode>> 12-67
Repeater Tone 12-12
Repeat Time 12-19
Reply Position Display 12-58
Resetting the CPU 17-2
Resume Timer 12-14

R (Continued)

- RX
 - RX Bass 12-44
 - RX Bass Boost 12-44
 - RX Call Sign 12-57
 - RX Call Sign SPEECH 12-46
 - RX>CS SPEECH 12-46
 - RX History
 - Adding the Repeater information 7-28
 - RX History items 12-38
 - RX History Log 12-49
 - Using the RX History 6-11
 - View in the RX History screen 7-6
 - RX Position Display 12-58
 - RX Position Display Timer 12-58
 - RX Position Indicator 12-57
 - RX REC Condition 12-17
 - RX Record (RPT) 12-45
 - RX Treble 12-44
- S**
- Saving onto an SD card
 - Save Setting 12-63
 - Saving data 9-3
 - Saving settings 6-37
 - Saving the setting data onto an SD card 9-6
 - Saving with a different file name 9-7
 - Scan
 - About the scan function 4-2
 - [DIAL] operation during a scan 4-3
 - Entering scan edges 4-12
 - Memory bank scan 4-2, 4-9
 - Memory scan 4-2, 4-8
 - Memory (skip) scan 4-8
 - Program Link 12-15
 - Program Scan Edge 12-14
 - Program Skip 12-14
 - Receive mode during a scan 4-3
 - Resume Timer 12-14
 - Scan 4-2
 - Scan function during Dualwatch mode 4-4
 - Scan items 12-14
 - Scan name 4-4
 - Scan Stop Beep 4-4, 12-61
 - Skip function 4-3
 - Clearing the skip frequencies 4-7
 - Setting and clearing the skip channel 4-10
 - Setting the skip frequencies 4-7
 - Setting the temporary skip function 4-11
 - Temporary Skip timer 4-3, 12-14
 - Squelch setting for a scan 4-3
 - Tuning step for a VFO scan 4-3
 - Scope AF Output 12-61
 - Scroll Speed 12-58
 - SD card
 - About the SD card 9-2
 - Backing up the data onto a PC 9-9
 - Export 9-12, 12-63
 - Format 9-4, 12-63
 - Import 9-11, 12-63
 - Inserting 9-4
 - Loading 9-8, 12-63
 - Making a backup file on your PC 9-10
 - Removing 9-5
 - Saving data 9-3
 - SD card's folder contents 9-9
 - SD Card Info 12-63
 - SD Card items 12-63
 - Separator/Decimal 12-49, 12-63
 - Serialport Function 12-66
 - Unmount 12-63
 - Viewing the SD card memory capacity 10-8
 - Sounds items 12-61
 - Specifications 16-2
 - General 16-2
 - Receiver 16-3
 - Transmitter 16-3
 - Speech function 2-17, 13-4
 - Alphabet 12-47
 - DIAL SPEECH 12-46
 - MODE SPEECH 12-46
 - SPEECH items 12-46
 - SPEECH Language 12-46
 - SPEECH Level 12-47
 - SPEECH Speed 12-47
 - Using the Speech function 13-4
 - Speed
 - Item 12-28
 - Object 12-25
 - Squelch
 - Squelch/ATT Select 12-52
 - Squelch Delay 12-52
 - Squelch setting for a scan 4-3
 - SSID
 - Item 12-29
 - Object 12-26
 - Position 12-22
 - Weather 12-30
 - Standby Beep 12-61
 - Sub Band Mute 12-61
 - Sweep operation 2-14
 - Symbol
 - Item 12-27
 - Object 12-24
 - Position 12-20
 - Weather 12-30
 - System Language 12-59

INDEX

T

Temporary Skip timer	4-3, 12-14
TIME	12-62
Time-Out Timer	12-55
Time set items	12-62
Time Stamp	
Object	12-26
Position	12-22
Weather	12-30
“TO” (Destination) setting	6-23
Tone Burst	12-12
Tone squelch frequency setting and operation	13-8
Tone squelch operation	13-8
Touch screen	
Touch Operation (Dimmed)	12-57
Touch Operation (Sub)	12-55
Touch screen calibration function	12-67, 13-23
Transmit	
Transmitting	2-12
About transmit power levels and RF meter	2-12
Transmitting a message	7-4
Transmitting D-PRS data	8-15
Transmitting GPS data (D-PRS and NMEA)	8-14
Transmitting NMEA data	8-27
Transmitting on an Amateur band	2-12
Troubleshooting	6-16, 17-4
Display	17-6
Scanning	17-6
Transceiver power	17-5
Transmit and receive	17-5
While operating D-STAR	17-4
While operating GPS logger	17-5
TSQL Freq	12-12
TX Bass	12-44
TX Call Sign	12-58
TX Format	12-20
Item	8-8
Object	8-8
Position (Base)	8-7
Position (Mobile)	8-7
Weather	8-9
TX Message	12-43
Entering	7-2
Deleting	7-5
TX mode: NMEA	8-9
TX Monitor	12-19
TX Treble	12-44
Type of position data	8-14

U

Unmount	12-63
Unproto Address	12-20
Up/Down MIC Key	12-52
UT-133 installation	15-5
UTC Offset	12-62

V

Version	12-67
VFO	
VFO frequency and a Memory/Bank scan	5-2, 5-6
VFO frequency and a priority channel	5-2, 5-4
VFO mode selection	2-9
VFO mode scan	4-5
VFO scan	4-2
VFO scan and a Memory/Bank scan	5-2
VFO scan and a priority channel	5-2, 5-8
VFO scan and Memory/Bank scan	5-10
Voice Memory	
Changing the recording mode	10-4
Delete an Audio File	10-6
Delete an Audio Folder	10-5
Play Files	12-17
Playing back the recorded audio	10-3
Playing back the recorded audio on the PC	10-9
Playing back the recording	10-3
REC Mode	12-17
Skip Time	12-18
Starting to record	10-2
Stop recording	10-2
Viewing the file information	10-7
Voice Memo items	12-17
Voice TX function	13-2
Changing the voice TX settings	13-3
Record	12-19
To transmit the recorded voice audio	13-3
Voice TX items	12-19
Voltage	12-67
Voltage (Power ON)	12-58
VOX	
VOX	12-64
VOX Delay	12-64
VOX function	15-8
VOX Level	12-64
VOX-related settings	15-9
VOX Time-Out Timer	12-64
Setting the VOX level	15-8
Using the VOX function	15-8
VS-3	
About the Icom headset (VS-3)	15-10

INDEX

W

Weather channel (USA version only)

- Weather alert function 13-10
- Weather channel mode selection 2-9
- Weather channel operation 13-10
- Weather channel selection 13-10

Weather

- Confirming the weather data input 8-25
- Weather setting (D-PRS) 8-23
- Weather data content 8-25
- Weather station transmission 8-25

Y

- Your Call Sign 12-41
- Your setting is correct? 7-36

Count on us!



Merci d'avoir choisi un produit Icom.
LIRE ATTENTIVEMENT ET INTEGRALEMENT CE
MANUEL avant toute utilisation de l'émetteur-récep-
teur.

Pour l'opération l'émetteur-récepteur

⚠ **NE JAMAIS** toucher l'antenne en cours d'émission ou de réglage d'accord. Au risque de provoquer un choc électrique ou des brûlures.

⚠ **AVERTISSEMENT! EXPOSITION AUX RADIOFREQUENCES!** Cet appareil émet de l'énergie radioélectrique (RF). Il doit être utilisé avec la plus grande prudence. Pour toutes questions quant à l'exposition aux ondes radioélectriques et aux normes de sécurité reportez-vous au rapport du Bureau Fédéral d'ingénierie et de Technologie de la Commission des Communications sur la mesure de la conformité aux règles de la FCC sur l'exposition de la personne humaine aux champs électromagnétiques des radiofréquences (OET Bulletin 65)

⚠ **AVERTISSEMENT! NE JAMAIS** utiliser l'émetteur-récepteur en conduisant un véhicule. La sécurité de la conduite requiert toute l'attention du conducteur — toute défaillance peut être à l'origine d'un accident.

⚠ **AVERTISSEMENT! NE JAMAIS** utiliser l'appareil avec un casque ou d'autres accessoires audio réglés sur un niveau sonore élevé. Les acousticiens mettent en garde contre toute utilisation continue à un niveau sonore élevé. En cas d'audition de sonneries, réduire le volume sonore ou interrompre l'utilisation.

⚠ **AVERTISSEMENT! NE JAMAIS** connecter l'émetteur-récepteur à une alimentation CA au risque de provoquer un incendie ou un choc électrique.

⚠ **AVERTISSEMENT! NE JAMAIS** brancher l'émetteur-récepteur sur une source d'alimentation de plus de 16 V CC. NE JAMAIS émettre lorsque le coupleur est activé (ON), alors qu'aucune antenne n'est raccordée, au risque d'endommager gravement l'émetteur-récepteur.

⚠ **AVERTISSEMENT! NE JAMAIS** brancher l'émetteur-récepteur sur une source d'alimentation en inversant la polarité. NE JAMAIS émettre lorsque le coupleur est activé (ON), alors qu'aucune antenne n'est raccordée, au risque d'endommager gravement l'émetteur-récepteur.

⚠ **AVERTISSEMENT! NE JAMAIS** couper le câble d'alimentation CC entre la prise CC à l'arrière de l'émetteur-récepteur et le porte fusible. L'émetteur-récepteur peut être endommagé par la suite en cas de connexion inappropriée.

⚠ **AVERTISSEMENT! NE JAMAIS** toucher l'antenne en cours d'émission. NE JAMAIS permettre le contact d'un objet métallique, d'un câble ou d'autres objets avec un des composants internes ou des connecteurs de la face arrière de l'émetteur-récepteur au risque de provoquer un choc électrique, un incendie ou d'endommager irréremédiablement l'émetteur-récepteur ou de régler d'accord.

⚠ **AVERTISSEMENT! NE JAMAIS** utiliser ou toucher l'émetteur-récepteur avec des mains mouillées. Cela peut occasionner un choc électrique ou endommager l'appareil.

⚠ **AVERTISSEMENT!** Éteindre immédiatement l'émetteur-récepteur et déconnecter le câble d'alimentation si l'appareil émet une odeur ou un bruit anormal ou de la fumée. Demander conseil au distributeur Icom le plus proche.

MISE EN GARDE: NE JAMAIS exposer l'émetteur-récepteur à la pluie, à la neige ou à tout autre liquide.

MISE EN GARDE: NE JAMAIS modifier les réglages internes de l'émetteur-récepteur au risque d'altérer les performances de l'émetteur-récepteur et/ou de l'endommager.

MISE EN GARDE: NE JAMAIS placer l'émetteur-récepteur à un emplacement où il pourrait gêner le fonctionnement normal du navire ou provoquer des blessures corporelles.

NE PAS utiliser l'émetteur-récepteur près d'amorces électriques non blindées ni dans une atmosphère explosive.

NE PAS appuyer sur la touche PTT sans intention réelle d'émettre.

NE PAS utiliser de solvants agressifs tels que l'essence ou l'alcool pour nettoyer le l'émetteur-récepteur, en raison des risques d'endommager la surface du l'émetteur-récepteur. En cas de dépôt de poussière ou de salissures sur l'émetteur-récepteur, il faut l'essuyer avec chiffon doux et sec.

ÉVITER d'utiliser ou de laisser l'émetteur-récepteur en plein soleil ou à une température ambiante inférieure à -10°C ou supérieure à +60°C. Noter que la température au niveau de la plage arrière ou du tableau de bord d'un véhicule peut dépasser +80°C, ce qui peut endommager irrémédiablement la face avant de l'appareil en cas d'exposition prolongée.

Pour l'opération l'émetteur-récepteur (Continue)

NE PAS placer l'émetteur-récepteur dans un environnement excessivement poussiéreux ou en plein soleil.

NE PAS placer l'émetteur-récepteur contre un mur. Placer l'appareil dans un endroit sûr hors de portée des enfants. Placer l'émetteur-récepteur hors de portée des enfants pour éviter toute utilisation inopinée.

En utilisation mobile, **NE PAS** placer l'émetteur-récepteur ni la face avant a des emplacements où ils pourraient entraîner le déploiement des airbags.

En utilisation mobile, **NE PAS** placer l'émetteur-récepteur ni la face avant a des emplacements où ils pourraient être directement exposés à un flux d'air froid ou d'air chaud.

En utilisation mobile, **NE PAS** utiliser un émetteur-récepteur embarqué avec le moteur du véhicule arrêté. Toute utilisation de l'émetteur-récepteur moteur arrêté a pour conséquence de vider rapidement la batterie du véhicule.

Vérifier que l'appareil est éteint avant d'actionner le démarreur du véhicule. Dans le cas contraire, les pics de tension d'allumage du moteur risquent d'endommager l'émetteur-récepteur.

En utilisation maritime mobile, maintenir l'émetteur-récepteur et le microphone aussi loin que possible du compas de route magnétique afin d'écartier tout risque de déviation de celui-ci.

ATTENTION! La température de la face arrière s'élève de manière importante en cas d'utilisation prolongée de l'émetteur-récepteur.

Utiliser exclusivement un microphone Icom (fourni d'origine ou en option). La répartition des broches des microphones des autres fabricants est différente et leur connexion à l'ID-5100A peut endommager l'émetteur-récepteur.

Pour l'opération Bluetooth®

⚠ **NE JAMAIS** toucher l'antenne en cours d'émission ou de réglage d'accord. Au risque de provoquer un choc électrique ou des brûlures.

⚠ **AVERTISSEMENT! EXPOSITION AUX RADIOFREQUENCES!** Cet appareil émet de l'énergie radioélectrique (RF). Il doit être utilisé avec la plus grande prudence. Pour toutes questions quant à l'exposition aux ondes radioélectriques et aux normes de sécurité reportez-vous au rapport du Bureau Fédéral d'ingénierie et de Technologie de la Commission des Communications sur la mesure de la conformité aux règles de la FCC sur l'exposition de la personne humaine aux champs électromagnétiques des radiofréquences (OET Bulletin 65)

⚠ **AVERTISSEMENT! NE JAMAIS** faire des changements ou modifications à l'émetteur-récepteur.

⚠ **AVERTISSEMENT! NE JAMAIS** utiliser ou toucher l'émetteur-récepteur avec des mains mouillées. Cela peut occasionner un choc électrique ou endommager l'appareil.

⚠ **AVERTISSEMENT! NE JAMAIS** toucher l'antenne en cours d'émission. **NE JAMAIS** permettre le contact d'un objet métallique, d'un câble ou d'autres objets avec un des composants internes ou des connecteurs de la face arrière de l'émetteur-récepteur au risque de provoquer un choc électrique, un incendie ou d'endommager irrémédiablement l'émetteur-récepteur. n ou de réglage d'accord. Placer l'émetteur-récepteur hors de portée des enfants pour éviter toute utilisation inopinée.

⚠ **AVERTISSEMENT!** Éteindre immédiatement l'émetteur-récepteur et déconnecter le câble d'alimentation si l'appareil émet une odeur ou un bruit anormal ou de la fumée. Demander conseil au distributeur Icom le plus proche.

NE PAS placer l'émetteur-récepteur contre un mur. Placer l'appareil dans un endroit sûr hors de portée des enfants.

NE PAS placer l'émetteur-récepteur dans un environnement excessivement poussiéreux ou en plein soleil.

NE PAS utiliser l'émetteur-récepteur près d'amorces électriques non blindées ni dans une atmosphère explosive.

NE PAS utiliser de solvants agressifs tels que l'essence ou l'alcool pour nettoyer le l'émetteur-récepteur, en raison des risques d'endommager la surface du l'émetteur-récepteur. En cas de dépôt de poussière ou de salissures sur l'émetteur-récepteur, il faut l'essuyer avec chiffon doux et sec.

NE PAS tomber, l'impact ou vibrer l'émetteur-récepteur. Cela peut endommager l'unité.